

Assembly Instructions (Read carefully before assembly.)

1. Cut out all parts using scissors.
2. Cut out V-shaped notches on Fuselage to create tabs along outside edge. Fold tabs out.
3. Glue or tape three Nose Weights to underside of glider nose. Use the fourth weight provided if needed for extra trim after assembly.
4. Fold Fuselage along middle line.
5. Starting at the nose, glue or tape fuselage to Deck and Wing Assembly. Match tabs on Fuselage exactly to those two halves together using tabs provided.
6. To close the nose, glue or tape the two halves together using tabs provided.
7. Fold Vertical Stabilizer Assembly. Fold out tabs A and B. Except for tabs A and B, glue or tape Vertical Stabilizer Assembly to make one solid piece.
8. Attach Vertical Stabilizer to Fuselage, matching tab A with point A and tab B with point B.

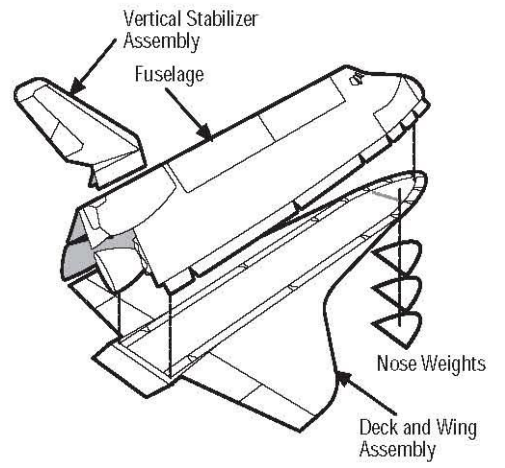

Preflight Instructions

For the best results, launch your glider with a gentle level toss. Bend the Body Flap for slightly greater lift.

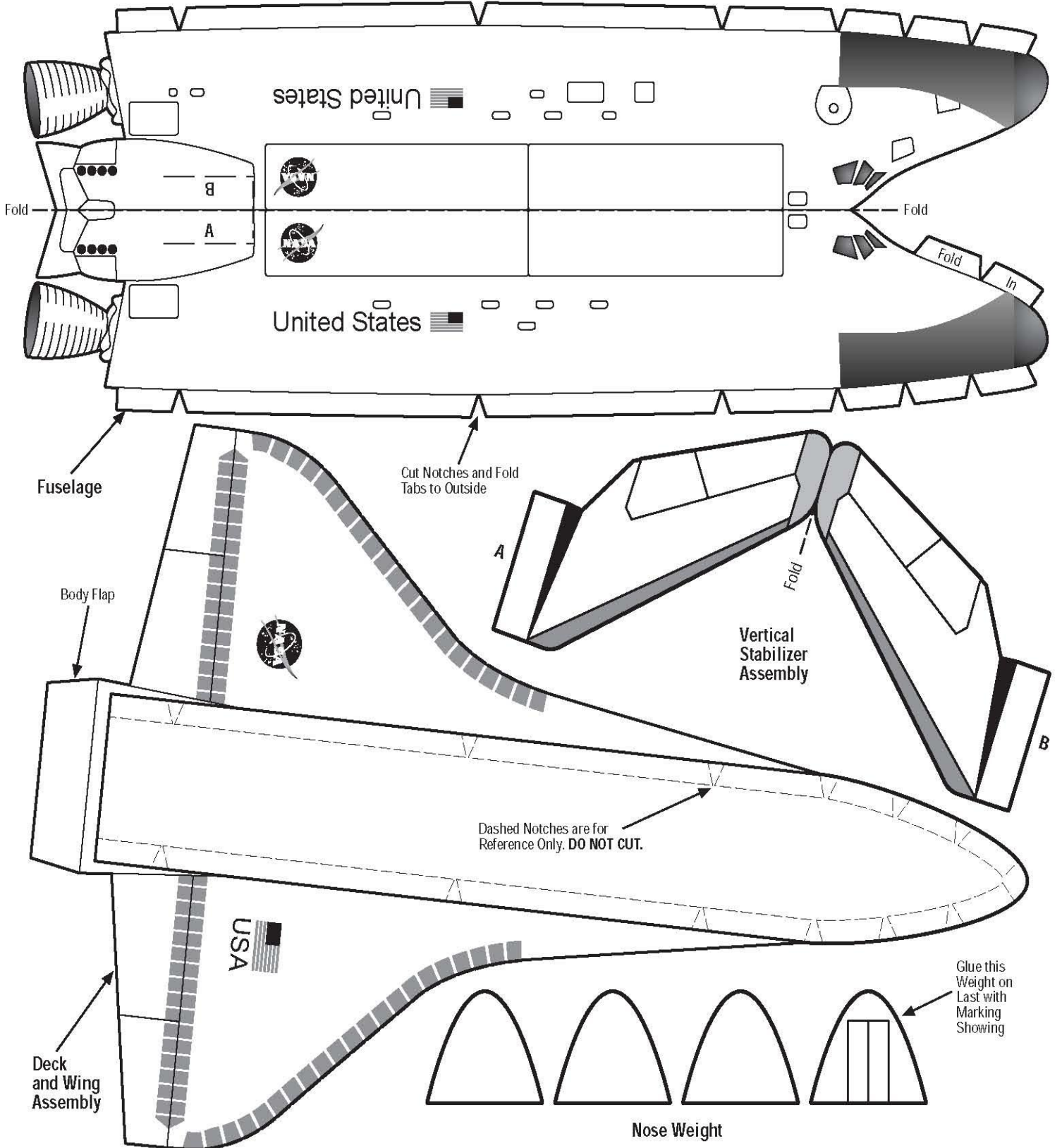

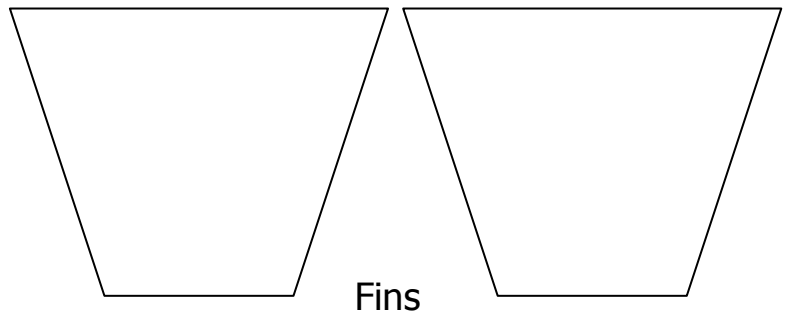
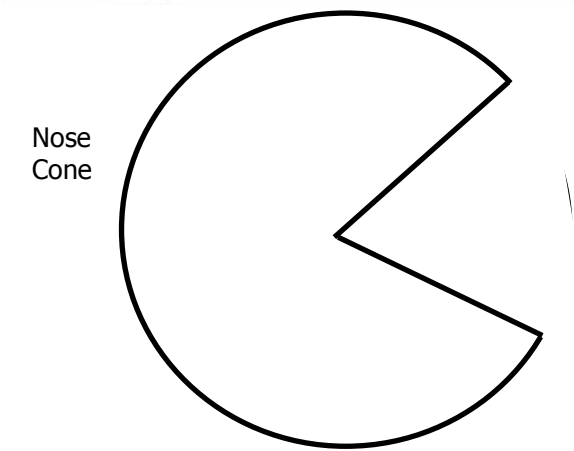
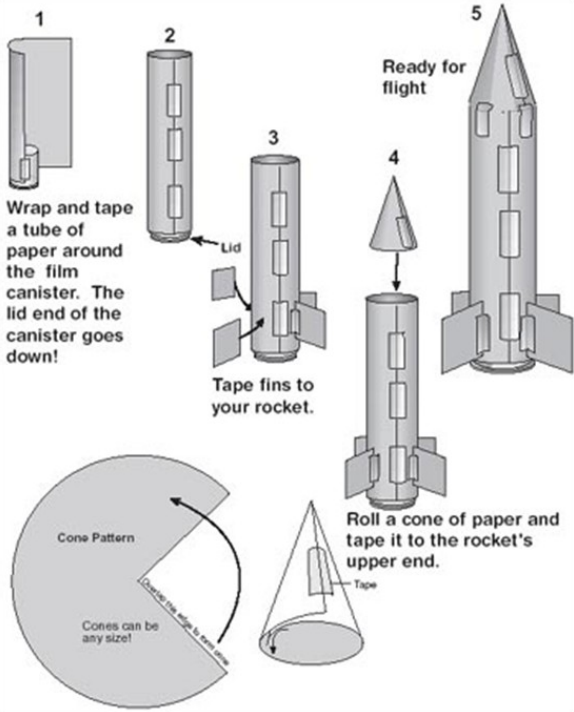

Fins

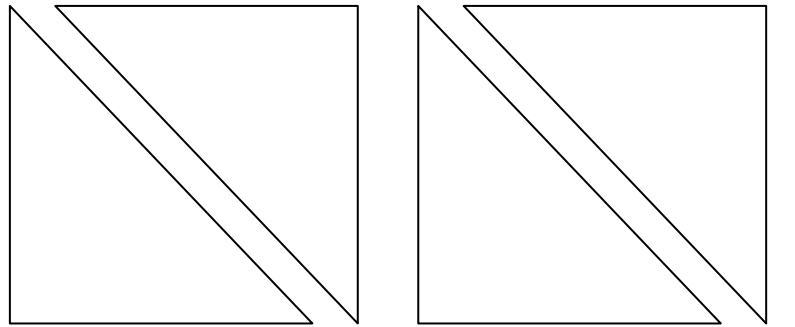
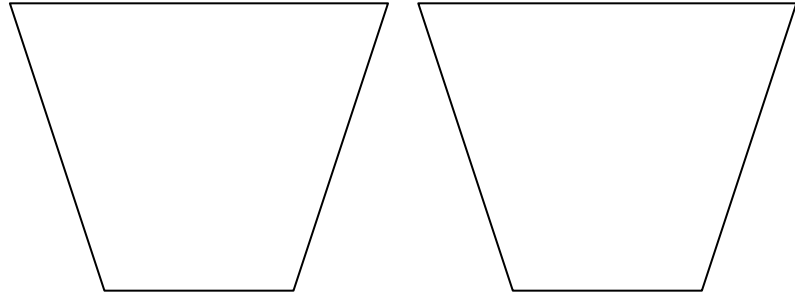

Use area below line to make your rocket

