

G U R P S<sup>®</sup>

# LENSMAN

*Starkly Astounding Space-Opera Adventure!*



BY SEAN BARRETT

BASED ON THE CLASSIC NOVELS BY E.E. "DOC" SMITH

**STEVE JACKSON GAMES**

G U R P S<sup>®</sup>

# LENSMAN<sup>™</sup>

*Starkly Astounding Space-Opera Adventure  
Based on the Classic Novels by E.E. "Doc" Smith*

**By Sean Barrett**

**Edited by Scott Haring  
and Steve Jackson**

**Cover by Kelly Freas**

**Back Cover Art by Dan Smith  
and Derek Percy**

**Illustrated by Dan Smith**

**Additional Illustrations by Denis Loubet**

*GURPS* System Design by Steve Jackson  
Lloyd Blankenship, Managing Editor  
Page Layout and Typography by Jeff Koke  
Interior and Color Production by Jeff Koke  
Proofreading by Spike Y. Jones  
Print Buying by Andrew Hartsock  
Dana Blankenship, Sales Manager

*The Playtesters of the Lens:* Leif Bennett, Winchell D. Chung, Ben Coombs, Scott Corum, Marc A. Dostaler, Dr. John S. Eickemeyer, David Gordon Empey, Robert Gilson, Nate Hanner, Travis Herring, Alexander Lewis Jones, Charles Keith-Stanley, Joseph Melton, H. Ian Novack, Laird Popkin, David L. Pulver, Tad Simmons, Timothy Tai and the Illuminati BBS.

*Advice and Assistance:* Kelly Freas, Dr. Laura Freas, Paul Hume, David Joiner and Bonnie Long-Hemsath.

*Special thanks to Verna Smith Trestrail and Susan Miller.*



*GURPS* and the all-seeing pyramid are registered trademarks of Steve Jackson Games Incorporated. *Pyramid* and Illuminati Online and the names of all products published by Steve Jackson Games Incorporated are registered trademarks or trademarks of Steve Jackson Games Incorporated, or used under license.

*Lensman* is a trademark of the E.E. "Doc" Smith Estate. All rights reserved.

*GURPS Lensman* is copyright © 1993 by Steve Jackson Games Incorporated. All rights reserved. Printed in the U.S.A.

ISBN 1-55634-283-7

1 2 3 4 5 6 7 8 9 10

# CONTENTS

## INTRODUCTION .....3

Additional Material.....	3
About GURPS.....	3
The First Historian.....	4
The Present Historian.....	4
Political Correctness.....	4
Characters From Other Campaigns.....	4

## HISTORY AND SOCIETY .....5

A Brief History of Civilization...	6
Lexicon.....	6
A Watchmaker Universe?.....	7
Three Views of Women.....	8
Women and Lenses.....	10
The "Little Lady".....	10
Meanwhile, In Another Universe.....	11
Officers' Specialties – Line and Staff Corps.....	11
The Academy.....	12
Scales of Mental Prowess.....	12
The Oath.....	12
The Galactic Union.....	13
Predecessors.....	13
Recognition.....	13
Klono's Anatomy.....	13
The Enemies.....	14
The Home Front.....	14
Societies.....	14
The Firsts.....	14
Taxes.....	15
Law Enforcement.....	16
Sexual Mores.....	16
Dissent.....	17
Religion.....	17

## CHARACTERS .....18

Character Points.....	19
Character Types.....	19
Advantages, Disadvantages and Skills.....	25
Advantages.....	25
Disadvantages.....	29
Skills.....	31
Language Skills.....	31
Economics, Jobs and Wealth.....	35

## RACES .....37

The Galactic Union's Racial Profile System.....	38
Palainians.....	38
Rigellians.....	39
Velantians.....	40
Arisians.....	40
Chickladorians.....	40
Delgonians.....	40
Dhilians and Nhalians.....	41
Eddorians.....	41
Eich.....	41
Jovians.....	42
Kalonians, Tomingans, etc.....	42
Lyranians.....	42
Martians.....	43

Nevians.....	43
Onlonians.....	43
Ploorans.....	43
Posenians.....	44
Vegians.....	44
Venerians.....	45
Valerians.....	45

## SAMPLE CHARACTERS.....46

Anson Maynard.....	46
Kimball Kinnison.....	47
Clarissa Kinnison, Neé MacDougall.....	48
Nadreck.....	49
Tregonsee.....	50
Worsel.....	51

## GAZETTEER.....52

Clear Ether.....	53
Ether Density.....	54
Loose Atomic Vortices.....	54
Other Tellus-Type Planets.....	55

## PLANETS.....56

Aldebaran ( $\alpha$ Tauri) I & II.....	56
Arisia.....	56
Bennett.....	56
Cavenda.....	57
Delgon (Velantia II).....	57
Eddore.....	57
Jamevon.....	57
Jupiter (Sol V).....	57
Klovvia.....	58
Lonabar.....	59
Lyrane II, VIII & IX.....	59
Mars (Sol IV).....	59
Nevia.....	60
Onlo (Thralis IX).....	60
Palain VII.....	60
Ploor (Rontieff I).....	61
Pluto (Sol IX).....	61
Rigel ( $\beta$ Orionis IV).....	61
Tellus (Sol III).....	61
Trenco.....	61
Valeria.....	62
Vegia ( $\alpha$ Lyrae V).....	63
Velan (Velantia III).....	63
Venus (Sol II).....	63
Zabriska (A-Zabriskae II).....	63

## TECHNOLOGY.....64

Technology Stage.....	65
Electronics.....	65
Tech Stages – History.....	65
Transportation and Communication.....	65
Ship Construction.....	66
Weapons and Armor.....	66
Power.....	66
Power Plant.....	67
Units.....	67
Dimensions.....	67
Screens.....	68
"Driving Jets".....	69
Upkeep.....	69
The Bergenholm Drive.....	70
Weapons.....	70

Planetary Bergenholms.....	72
----------------------------	----

Sensors and Communications.....	73
------------------------------------	----

Assault on Helmuth.....	73
-------------------------	----

Missiles and Shells.....	74
--------------------------	----

Gravity and Inertia Technology.....	75
--	----

The Rescue of Medon.....	75
--------------------------	----

The Z9M9Z at the Battle of Midway.....	76
---	----

Weapons of Mass Destruction.....	77
----------------------------------	----

Demolitions.....	77
------------------	----

Chemical Weapons.....	77
-----------------------	----

Brute-Force Inerting: The "Net".....	77
---	----

Inert Collisions.....	78
-----------------------	----

Negaspheres.....	78
------------------	----

Beams of Force.....	78
---------------------	----

Annihilation of a Planet.....	78
-------------------------------	----

Sunbeams.....	79
---------------	----

A Note on "Free" Combat.....	79
------------------------------	----

Weapons of Individual Destruction.....	80
---	----

DeLameters.....	80
-----------------	----

Lewistons.....	80
----------------	----

Spybeam.....	80
--------------	----

Nevian Paralysis Projector.....	81
---------------------------------	----

Standish.....	81
---------------	----

Space-Axe.....	81
----------------	----

Personal Armor.....	81
---------------------	----

Armor.....	81
------------	----

Hand Thruster.....	81
--------------------	----

Magnetic Boots.....	81
---------------------	----

Power Cells.....	82
------------------	----

Weapon and Armor Tables.....	83
------------------------------	----

Medical Technology.....	83
-------------------------	----

Phillips Regeneration.....	83
----------------------------	----

Replacing Power Cells.....	83
----------------------------	----

The Hyper-Spatial Tube.....	84
-----------------------------	----

Psionic Devices.....	84
----------------------	----

Heavy Weapon Harness.....	84
---------------------------	----

Hyper-Rotation and Dureum.....	84
--------------------------------	----

Broadcasters.....	85
-------------------	----

Thought-Screens.....	85
----------------------	----

Legal Drugs.....	85
------------------	----

Illegal Drugs.....	86
--------------------	----

Thionite.....	86
---------------	----

Toxicity.....	87
---------------	----

Thionite Examples.....	87
------------------------	----

## SAMPLE SHIPS .....89

## TELEPATHY AND THE LENS .....91

The Lens.....	92
---------------	----

Improving Telepathic Abilities.....	92
-------------------------------------	----

Telepathy.....	93
----------------	----

Telepathic Skills.....	93
------------------------	----

Area Attacks.....	93
-------------------	----

Ricochets.....	95
----------------	----

Deathscream.....	96
------------------	----

Combination Attacks.....	97
--------------------------	----

Advanced Techniques.....	98
--------------------------	----

Telereceive in Battle.....	98
----------------------------	----

Undetectable Mindwipe.....	99
----------------------------	----

Wide-Open Two-Way.....	99
------------------------	----

Wide-Open N-Way.....	100
----------------------	-----

Detecting Mindwipe.....	100
-------------------------	-----

Enhancements and Limitations.....	101
--------------------------------------	-----

Telepathic Eavesdropping.....	101
-------------------------------	-----

Telepathic Assistance.....	102
----------------------------	-----

## COMBAT .....103

Space Opera Combat System.....	104
--------------------------------	-----

"The Scream of Escaping Air...".....	104
---	-----

Ship Classes.....	105
-------------------	-----

"... in the event of a loss of cabin pressure...".....	105
---	-----

Craft Ratings.....	106
--------------------	-----

Damage.....	106
-------------	-----

Kamikaze Attacks.....	106
-----------------------	-----

Inter-Ship Relationships.....	107
-------------------------------	-----

Precision Gunnery Basic Combat.....	108
--	-----

Turn Sequence.....	108
--------------------	-----

Follow-the-Leader – or "You'll kill us all!".....	108
--	-----

Cutter and Ship of the Line Combat.....	109
--	-----

Unorthodox Tactics – or "Have you gone mad?!".....	109
---	-----

Advanced Combat.....	110
----------------------	-----

The Furball.....	110
------------------	-----

Inventing Maneuvers.....	111
--------------------------	-----

SOCS in Lensman.....	112
----------------------	-----

Ratings.....	112
--------------	-----

The Battle.....	112
-----------------	-----

Screens.....	112
--------------	-----

Battle Stations!.....	112
-----------------------	-----

Macro Beams.....	113
------------------	-----

Needle Beams.....	113
-------------------	-----

Damaging Inertialless Objects.....	113
---------------------------------------	-----

Martial Arts.....	114
-------------------	-----

New Maneuvers.....	114
--------------------	-----

Example of Lensman Combat.....	114
-----------------------------------	-----

Styles.....	115
-------------	-----

Thuleschlag (Jovian Adept Combat).....	116
---	-----

--	--

## CAMPAIGNS .....117

Cinematic Play.....	118
---------------------	-----

Villain-Driven Plotting.....	119
------------------------------	-----

Clint's DeLameter?.....	119
-------------------------	-----

Viewpoint.....	120
----------------	-----

Balance.....	120
--------------	-----

Time Period.....	121
------------------	-----

The Triplanetary and Solarian Leagues.....	121
---	-----

The Galactic Union.....	121
-------------------------	-----

The War.....	121
--------------	-----

Arisia and Eddore.....	121
------------------------	-----

The Spawn.....	122
----------------	-----

Peace.....	122
------------	-----

The Lens Across Genres.....	122
-----------------------------	-----

Adventure Seeds.....	122
----------------------	-----

100 Points – "Citizen of the Galaxy".....	122
--	-----

200 Points – "Galactic Patrolman".....	123
---	-----

400 Points – "Lieutenant Lensman".....	124
---	-----

Theme Music.....	124
------------------	-----

1,000 Points – "Unattached".....	125
-------------------------------------	-----

"Guardians of Civilization".....	125
----------------------------------	-----

## BIBLIOGRAPHY .....126

## INDEX .....127

# INTRODUCTION

Two thousand million or so years ago two galaxies were colliding; or, rather, were passing through each other." So begins the Epic of Space; so begins the war for freedom. The story does not stop until the human race produces its ultimate development: minds of such maturity that they can *think* — think with drive, scope and clarity — think so competently as to be able to visualize the details of the entire macrocosmic universe, from the instant of its creation to its ultimate end.

Two races are already ancient when the saga begins. Eddore seeks conquest, and on the myriads of planets formed during the interpassage of galaxies they find life enough to temporarily sate even their lust for dominion. Arisia opposes them, but cannot stop them without help. That help is the Galactic Patrol, and its assemblage has taken several long Arisian lifetimes, two thousand million years.

The work is done in complete secrecy, for if Eddore learns of the plan prematurely, its failure is certain. Even more, Civilization itself must not learn of its ultimate purpose, for that knowledge would introduce an inferiority complex that would ruin it forever. The Patrol believes it is fighting a war on drugs and piracy. The true scope of the War, though, can only be fully comprehended by entities of the third level of development. It is nothing less than the War of Good and Evil.

This book describes that conflict's final phase, the Boskonian War, from the invention of the Bergenholm inertialess drive by the Triplanetary League through the annihilation of dread Ploor.

The Ultimate War has begun. Many of you won't come back. But Lensmen always go in.

## ● ADDITIONAL MATERIAL

The *GURPS Basic Set* is required to use this worldbook. GMs will find *GURPS Space* and *GURPS Psionics* useful as well. Though an interesting assortment of technology is described in Chapter 5, some weapons and equipment from *GURPS Ultra-Tech* may be used in *GURPS Lensman* campaigns. Similarly, several alien races are described in Chapter 3, but many more exist throughout the galaxies, and a GM will find *GURPS Aliens* useful in describing them. The martial arts practiced by the various peoples of Civilization and Boskonian are surveyed in Chapter 7, though a GM will need *GURPS Martial Arts* to make use of that information.

GMs should read the Lensman series to understand the unique feel of this universe. *GURPS Lensman* is based on those books. William B. Ellern's stories, and David Kyle's trilogy about the nonhuman Second-Stage Lensmen, were used where they did not contradict the original series. Several other books are listed in the bibliography that are not strictly compatible with the Lensman series, such as *Spacehounds of IPC*, but which have similar tones and may enhance a Lensman campaign.

There exists a Japanese anime and comic book series with the same name as this work. It has nothing whatsoever to do with Doc's story, and is not authorized.

## About GURPS

Steve Jackson Games is committed to full support of the *GURPS* system. Our address is SJ Games, Box 18957, Austin, TX 78760. Please include a self-addressed, stamped envelope (SASE) any time you write us! Resources now available include:

*Pyramid*. This bimonthly magazine includes new rules and articles for *GURPS*, as well as information on our other lines: *Car Wars*, *Toon*, *Ogre Miniatures* and more. It also covers top releases from other game companies — *Traveller*, *Call of Cthulhu*, *Shadowrun*, etc.

*New supplements and adventures*. We're always working on new material, and we'll be happy to let you know what's available. A current catalog is available for an SASE.

*Errata*. Everyone makes mistakes, including us — but we do our best to fix our errors. Up-to-date errata sheets for all *GURPS* releases, including this book, are always available from SJ Games; be sure to include an SASE with your request.

*Q&A*. We do our best to answer any game question accompanied by an SASE.

*Gamer input*. We value your comments. We will consider them, not only for new products, but also when we update this book in later printings!

*Illuminati Online*. For those who have home computers, SJ Games has an online service with discussion areas for many games, including *GURPS*. Here's where we do a lot of our playtesting! It's up 24 hours per day at 512-448-8950, at up to 14.4K baud — or telnet to io.com. Give us a call! We also have discussion areas on CompuServe, GENie, and America Online.

## Page References

Rules and statistics in this book are specifically for the *GURPS Basic Set*, Third Edition. Any page reference that begins with a B refer to a page in the *Basic Set* — e.g., B102 means p. 102 of the *Basic Set*, Third Edition.

Page references that begins with an S refer to a page in *GURPS Space*. Other references are MA for *GURPS Martial Arts*, MAA for *GURPS Martial Arts Adventures* and UT for *GURPS Ultra-Tech*.

## Political Correctness

The *Lensman* series was written years before World War II by a man who grew up in the 1910s. It is sometimes accused of being *sexist*. Equal justice under the law for both sexes is a fundamental principle of Civilization, but Doc did *not* think men and women were equal (any more that he thought all men were equal; as Heinlein said, “he would as lief equate oranges with apples”). The entire *Lensman* saga is predicated on the fact that humans are extremely *unequal*.

**GURPS** *Lensman* describes Civilization the way Doc created it. “He” is the generic third-person singular pronoun, and it may or may not include females. Sex-specific occupational titles, such as steward and stewardess, will be used where appropriate.

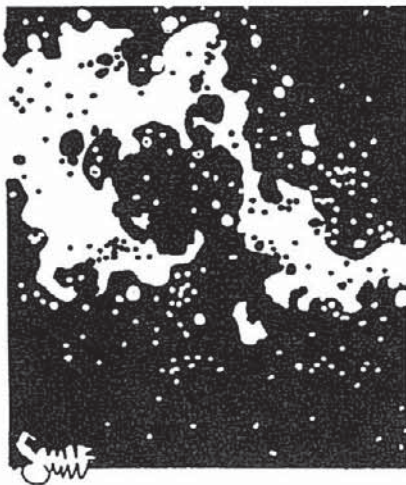

## Characters From Other Campaigns

Characters from other campaigns may encounter some difficulties fitting into a *GURPS Lensman* adventure. If they are from a high-tech background, they will find the Galactic Patrol's equipment incomprehensible, since they will be unfamiliar with both the high power usage and the vacuum tube technology. (Even if the characters have a tube background, those of the Patrol will be far more sophisticated than anything they have ever seen.) If the new characters are from a low-tech environment, they will be even more lost. The psionic powers of nearly every race in *GURPS Lensman*, augmented by the Lens, will render trivial even many *Supers* abilities. Magic simply doesn't work. But most importantly, the newcomers were probably not raised in a society that values the ability to *think* and requires a moral stature uncommon elsewhere.

## ◎ THE FIRST HISTORIAN

The significance of the *Lensman* series cannot be overestimated. In 1966 it was nominated for a special Hugo Award as “Best All-Time Series.” It was the first multi-volume science fiction novel ever published — conceived from the beginning as a single story line. From our viewpoint here in the future, Doc's courage is not obvious. We have seen many interminable series, designed never to end. Once parts of Doc's story had appeared in the pulps, though, he could not expect them ever to be reprinted. But the First Historian of Civilization planned a story with the full scope and range of his imagination, and wrote it with the drive it deserved.

Edward Elmer Smith was born in 1890. In 1915, he married Jeanne MacDougall and began collaborating on *The Skylark of Space*. In 1918, he earned his Ph.D. in chemistry and later became Chief Chemist for a company specializing in doughnut mixes. He had three children, Verna, Clarrissa and Roderick. During World War II, he was head of the Inspection Division of an ordnance plant at a laboratory called “Outer Siberia,” but was fired for refusing to pass substandard shells. Doc was a master of many professions including lumberjack and carpenter, cereal and explosives chemist, chemical and mechanical engineer, metallurgist, blacksmith and machinist, hardrock miner, photographer, and cook. In university, he captained a crack drill and rifle team, sang in Gilbert and Sullivan light operas, and was president of the mandolin and guitar club. The remarkable skills of Doc's characters are sometimes hard to believe. Doc made them as capable as he, and Doc was a starkly incredible man.

Doc was Guest of Honor at the Second World Science Fiction Convention, and was inducted into the First Fandom Hall of Fame at the 21st Worldcon. He was a true fan. At the second Worldcon, he attended the masquerade in his leather motorcycle garb with a homemade raygun as a C.L. Moore character, Northwest Smith. He contributed frequently to fan magazines.

On 31 August 1965, the First Historian suddenly left this plane of existence; his friend Robert Heinlein reported that he had “urgent business a long way off, no time to spare to tell us more stories.”

## The Present Historian

Sean Barrett has been, in accord with the Guardians' Visualization, readied to some extent for his present task; *Galactic Patrol* was the first science fiction book he read. However, since his introduction to the First Historian, his preparation has continued for only little more than two-and-a-half decades.

He has trained only as a short-order cook and an operator of the prodigious atomic engines of submarines, a tutor of mathematics and physics and a nucleonicist at the recovery from the hellish disaster of a melted atomic pile, an actor on stage and film and a journeyman programmer of electronic automatic computers. His only foreign language is Japanese. His unarmed combat skills are barely adequate, his swordplay unoriginal and his marksmanship unremarkable.

He fully realizes that this brief and narrow training leaves him starkly unqualified to continue the monumental History. He has consulted several entities who were contemporaneous and familiar with the First Historian, and extends heartfelt thanks for their help. In particular, Kelly and Laura Freas and Verna Smith Trestrail were utterly invaluable.

Even more vital was the help and true love of the Historian's wife and First Reader, Susan Miller. This manual could not have been produced without her, nor without the three requisite Lenscats.

*Respectfully submitted,  
Sean Barrett, Tellus*

# HISTORY AND SOCIETY

## CHAPTER ONE

The First Historian, writing shortly after the Boskonian War, concentrated on the technology and military history of Civilization. At the time, there was great interest in the battles and campaigns of the War, and little in the details of popular culture. Two generations later, however, interests have changed. Many of us have never seen a ration book or an issue of the *Galactic Patrol Journal of Recognition*. This chapter will summarize some of the salient characteristics of civilian Civilization during the War.

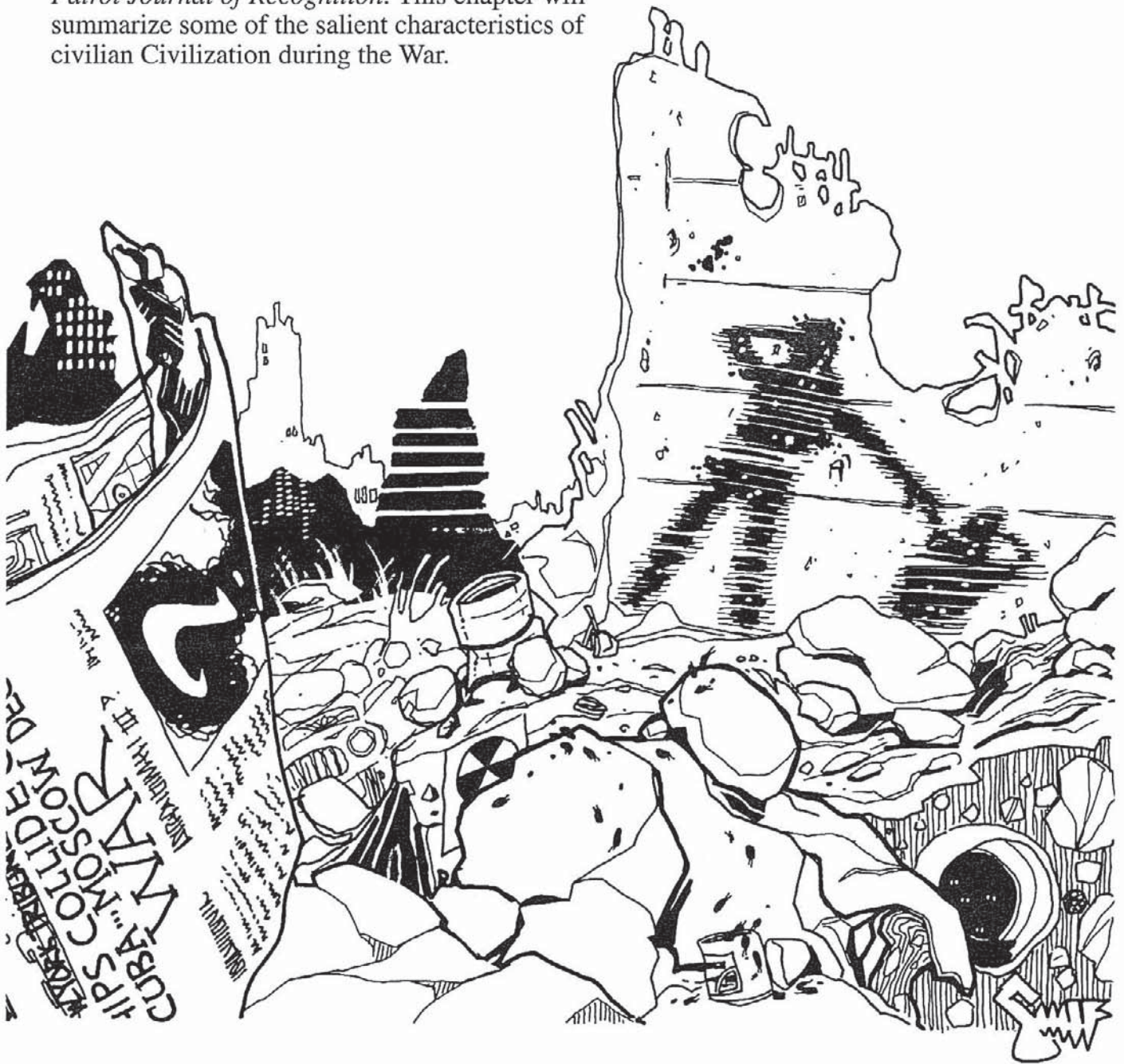

## ◎ A BRIEF HISTORY OF CIVILIZATION

### Lexicon

Doc's characters, like their author, have vocabularies that are not only large and precise, but are also laced with technical jargon and esoteric slang.

**actinic:** Radiant and causing change.

**branchiate:** Divided into branches.

**carapaceous:** Having an armored covering.

**comminute:** To reduce to small particles.

**corpuscle:** A small body or particle.

**coruscate:** To flash or blaze.

**dernier cri:** French, "the last cry" — the latest fashion.

**estivate:** To lapse into torpor because of heat, dryness or similar conditions.

**fulgurate:** To shoot out beams.

**goniometer:** A device for measuring angles (*not* so-called because of its use in navigation sets to determine which way you're goin').

**jets:** Slang: capability, speed.

**klystron:** A type of vacuum tube in which the distinguishing features are the modulation or periodic variation of the longitudinal velocity of an electron stream without appreciable variation of its convection current and the subsequent conversion of this velocity modulation into convection-current modulation by the process of punching.

**integument:** Surface, skin, covering.

**nascent:** New-born.

**picaroon:** A tool, similar to a boat-hook, used to moor lumber.

**polydactile:** Many-fingered.

**QX:** Slang: all right, okay, roger.

**refractory:** Tough, resistant.

**selah:** Hebrew, a Biblical expression signifying completion.

**seven-sector call-out:** A situation commanding the attention of the military forces of seven sectors. Slang: a woman attractive enough to do the same.

**scintillate:** To sparkle.

**steatopygous:** Having large buttocks.

**thyatron:** A hot-cathode, gas-discharge tube in which one or more electrodes are employed to control electrostatically the starting of the unidirectional current flow.

**zymolose:** Disease-bearing.

- LENSMAN'S SEAL -

- DO NOT DUPLICATE - YOUR PERCEPTION ONLY -

THIS INFORMATION IS RESTRICTED UNDER LENSMAN'S SEAL  
BY UNATTACHED LENSMAN CHRISTOPHER KINNISON,  
AND MAY NOT BE DISTRIBUTED UNDER ANY CIRCUMSTANCES.

While the interpassage of the Milky Way and Lundmark's Nebula was creating millions of millions of planets, two ancient races were already in genocidal conflict.

Arisia saw the myriads of planets as a chance to cultivate races into a Civilization of seekers after truth. The alien Eddorians, intruders from another space-time continuum, saw opportunity for conquest. Each Eddorian could be master of millions of worlds, with the All-Highest the future ruler of an entire universe.

The Elders of Arisia watched and studied. They realized that, at best, they could achieve only a stalemate unless their planned Civilization was protected and guided for untold ages. Most importantly of all, no entity, anywhere, must ever learn of the conflict raging over its very existence. Such knowledge would instantly shatter any mentality not stable at the third level of stress and create a racial "inferiority complex" that would render that entire Civilization impotent. If secrecy could be maintained and Eddore held off long enough, though, a handful of entities would grow strong enough to destroy Eddore — indeed, they would be so powerful as to render Arisia itself obsolete. On four planets — Sol III (Tellus), Rigel IV, Velantia III and Palain VII — special breeding programs were initiated. The fourply Arisian mentality known in fusion as Mentor protected and promoted selected bloodlines on each.

### **Arisia, Pleistocene Epoch, Quaternary Period**

*"But the loss of life! Surely there is a way . . ."*

*"Your thinking is loose and turgid, youth. Do not allow affection for the subjects to interfere with your reasoning. Continue the extrapolation. Yes, the war would be prevented. What would then occur?"*

*"With the vast improvement in electronics, they would quickly develop . . ."*  
*The Arisian child possesses no organs even remotely resembling eyes, but had he, they would grow wide as he pursues the thought. "In a single generation, they would abdicate control of every aspect of life, down to food preparation utensils, to the ubiquitous electronic data processors! They would rely on machines for precise, detailed reasoning, for clarity of cogitation — but the powers of the mind necessary to Civilization cannot be simulated by electronics!"*

*"Yes," the teacher replies dryly. "Some would even become so desperate as to implant electronics into their own bodies. Is the war not better than an entire race reduced by dependence on cybernetics to punks and mental cripples? Describe a prevention of that fate that has minimal side-effects."*

*"Obviously, the humans Bardeen, Brattain and Shockley must not invent this 'transistor' device." A mental silence falls as the student contemplates methods. Elegance governs. A human heart would have pulsed several times before the child again broadcasts his thoughts. "I suggest spatial translation of this fastening device a short distance in nearly any direction, removing it from the path of this transportation mechanism." He indicated in a purely mental fashion a precise point in space-time.*

*"Yes," replies the teacher. "Many consider that the optimal course. Now, consider . . ."*

*The teacher exerts himself to hide the pride he feels. This is, in fact, the course Mentor themselves selected. This youth, Eukonidor by symbol, has real promise.*

### **Alabama, Tellus, 1932 CE**

*Dr. Murray, driving late into the night, remains forever oblivious to the nail he nearly drove over. Fighting to keep his eyes open, he pulls off the road outside the tiny town of Athens, Alabama for forty winks. Dawn finds him snoring, and he awakes with a vicious crick in his neck.*

*At the exact moment he sees the girl climbing the tree, she is 143.213 feet from him (which the Arisian teacher accepts as being within the error constraints of the student's visualization). As he rolls his head, trying to loosen his neck muscles, he is in perfect position to see her lose her grip and fall, striking a bough heavily before plummeting to the ground.*

*Dr. Murray leaps from the car and reaches her in 23.17 seconds (which causes the teacher to remind the child that physical life frequently operates at less than full capacity). The ground is soft, but the impact of the branch across her abdomen cracks several ribs and stops her breathing. Artificial respiration is successful, and Ruth recovers quickly and fully, though it is quite clear that she would have suffocated, had Dr. Murray not been present.*

### **Boston, Tellus, 1944 CE**

*Bill Shockley sits in the corner of the party, deep in thought and wishing he had his slip-stick and a supply of scratch paper, or even a corner of the tablecloth to sketch on. An idea is nagging at him, but refuses to completely gel.*

*"Hello there."*

*He looks up, and the idea flees before red-bronze-auburn hair and gold-flecked, tawny eyes. He and Ruth Sommer know nothing of the rest of that party, though it is the most delightful of the many they attend. They spend the entire evening sitting in that corner, in rapt and exclusive conversation. She continues to monopolize all of his free time and thought, and much thought that should be devoted to his work at Bell Labs. Even were he reminded of that fascinating idea he had almost had, he would never regret its loss — his beautiful wife is considerably more than worth it.*

### **Stockholm, Tellus, 1956 CE**

*William Shockley, John Bardeen and Walter Houser Brattain share the Nobel Prize in Physics for their revolutionary "ultra-wave" vacuum tube design.*

### **Stockholm, Tellus, 1958 CE**

*Pavel Aleksejevic Cherenkov, Ilya Mickajlovic Frank and Igor Evgenevic Tamm share the Nobel Prize in Physics for their studies of the effects of the superluminal speeds found in the Shockley ultra-wave tube (including the "Cherenkov effect"). Hundreds of years later, Dr. Nels Bergholm finds their work seminal in his research.*

### **Cuban Coastal Waters, Tellus, 1962 CE**

*During the Cuban Blockade, a dense fog, an exhausted lookout and a failed thyatron in a radar set cause an American destroyer to ram and sink a Cuban "fishing" vessel. The Soviet Union proclaims the incident an act of war and retaliates. Tellus is ruined for many hundreds of years.*

The Third or Atomic Phase of the World War was so devastating that the Eddorian second-in-command, Gharlane, assumed that he could divert attention from troublesome Tellus to the other worlds. On returning to the solar system, however, he found space-travel, great scientific progress, and continental governments ruling Venus, Tellus and Mars. Using the *nom de guerre* of Gray Roger, he formed the occult and esoteric Adepts of North Polar Jupiter and led them into direct war against the Inner Planets — only to see the conflict unite them into the Triplanetary League.

At the height of Gray Roger's assaults, Mentor caused Nerado of Nevia to discover the solar system, where he found tremendous supplies of the iron his world desperately needed. The three-way conflict was quickly resolved, in large part by

## **A Watchmaker Universe?**

The theoretical limits to precise knowledge are confirmed and illustrated by the abilities of sufficiently advanced intellects. In particular, two theorems and a field of study make it seem impossible to place any reliance on any but the most elementary visualizations. Yet, it is the proper use of just these seeming barriers to prediction which guide and inform the Arisians' Visualization. Heisenberg's Uncertainty Principle indeed indicates that even Mentor knows neither exactly nor completely the conditions pertaining at any given moment; his Visualization is complete and precise enough to predict gross details — *e.g.*, the sex of a given kitten two cat-generations from now — with ease and reliability. Proper application of chaos theory allows the Visualization of more challenging details — *e.g.*, the precise mass, length and orientation of tens of thousands of hair clippings.

Gödel's Undecidability Theorem indicates that the truth of some propositions cannot be determined by any level of intellect. In particular, it is impossible to predict the actions of an intellect who is of the same level of development as the predictor and is *trying* to be unpredictable. In accord with this principle, the Arisians kept their existence a secret — as long as the Eddorians believed they were unchallenged, their actions could be forecast.





## Three Views of Women

### *The Gentler Sex*

In a repressive society, women are discriminated against, both by opinion and by law. Societies of this type will be common if Lenses are not made for women, since Arisia validates the opinion that women are not "meant" to serve in dangerous positions — or that they are less capable. If the Galactic Patrol takes this attitude, women may only serve in limited capacities, such as nurses and clerical positions. All females of such societies or the Patrol have Social Stigma: Second-Class Citizen. A very few, very capable and very determined women can rise to medium levels of prominence — and their Social Stigma is that of Minority Group.

### *Not Separate, But . . .*

#### *Not Quite Equal*

Often, women are not discriminated against by law, but society at large discourages them from certain activities, and women must constantly strive against subtle suppression. A "glass ceiling" exists at the middle-management level that only remarkable women can penetrate.

Even if Arisia gives Lenses to women, it could remain the official policy of the Galactic Patrol that women *may* not be Lensmen. Women would not be permitted to serve in combat roles (to have the Extremely Hazardous Duty disadvantage), and Lensmen would be legally defined to be always in combat roles. There would be no rationale for this policy — it merely reflects the "women and children first" attitudes that permeate human-dominated Civilization. This policy would never be waived. It could only be overridden, and only by those rare and puissant entities authorized to violate Patrol regulations with impunity, the Gray Lensmen. Even they would consider it only in extreme and very special cases, and refer their need to one of the Second-Stage Lensmen, who in turn consult directly with Arisia. The standards by which Arisia might evaluate such a woman are unknowable — the cases in which a woman was given a Lens would be far too rare to permit anything more than the vaguest generalities. Minimum criteria would certainly include a Gray Lensman Contact (or better), and sufficient Reputation to overcome the Social Stigma of being a woman.

*Continued on next page . . .*

the efforts of the Triplanetary Service and its chief, Virgil Samms. Gray Roger was apparently destroyed and the Triplanetario-Nevian Treaty of Peace made the newly formed Solarian League well aware of intelligent life outside the Solar system.

Eddore, blocked from direct conquest by Gharlane's defeat, retrenched itself as Boskone, a complex of pathologically multi-nested conspiracies of piracy, drugs and vice of every kind, dedicated to the subversion and overthrow of the Galactic Union and its Patrol. The invention of the Bergenholm inertialess drive made faster-than-light travel trivially cheap and easy . . . and simultaneously made law enforcement all but impossible.

Through Nels Bergenholm — a Tellurian scientist occasionally energized by various Arisians — Samms was informed of the Lens, an instrumentality constructed by Mentor that served as an unimpeachable identifier, a perfect decoder of any intelligent communication and a telepath. Generations of Lensmen served Civilization as it grew throughout the First Galaxy for centuries.

When young Kimball Kinnison, the male penultimate in Mentor's breeding program for humanity, graduated from the Patrol's Academy on Tellus and received his Lens, Boskone's piracy was a serious problem to the Galactic Patrol. The pirates' technology was superior to the Patrol's, and their organization and tactics were much more militaristic than would be expected from a band — however well-led — of criminals. Kinnison's first assignment was to capture a Boskonian ship and analyze its power source, a method of tapping directly into cosmic energy. He succeeded, and while eluding the pursuit coordinated by Helmuth, Speaker for Boskone, discovered the planet Velantia III — and Worsel, the male penultimate of another of Arisia's breeding lines. (Rigel, Palain and Tellus had long been active members of the Galactic Union by this time.)

Worsel was the first entity, followed closely by Kinnison, to realize that Arisia could provide more training than the minimum necessary to wear the Lens, and they became the first Second-Stage Lensmen. Worsel concentrated on freeing his home world from the domination of the Overlords of Delgon, while Kinnison employed subterfuge and guile as well as all-out war, building in the minds of Boskone's leadership the image of a super-Lensman, code-named Star A Star, who had thousands of agents working in unison against them. Beginning with Helmuth's ultra-protected Grand Base, he destroyed his way up one of the Boskonian chains of command until he obliterated the Council of Boskone themselves and their home planet Jarnevon.

Later, Kinnison came to realize that the power structure of the conspiracy of Boskone was neither linear nor single-threaded, and that by annihilating Jarnevon, he had lost all connection with what lay behind the "Council of Boskone." With the other Second-Stage Lensmen and penultimates of their lines — Worsel of Velantia III, Tregonsee of Rigel IV and Nadreck of Palain VII — Kinnison began a new search, this time through gem-smuggling and space piracy to the planets Lyrane II and Lonabar. Recognizing that males couldn't work effectively with the matriarchal Lyranians, Kinnison gave Lensman training to Clarrissa MacDougall and sent her — the penultimate of the human female line and only human female to ever wear a Lens — to Lyrane. She discovered a connection, through a band of Overlords of Delgon on Lyrane II and an Eich base on Lyrane VIII to the Second Galaxy.

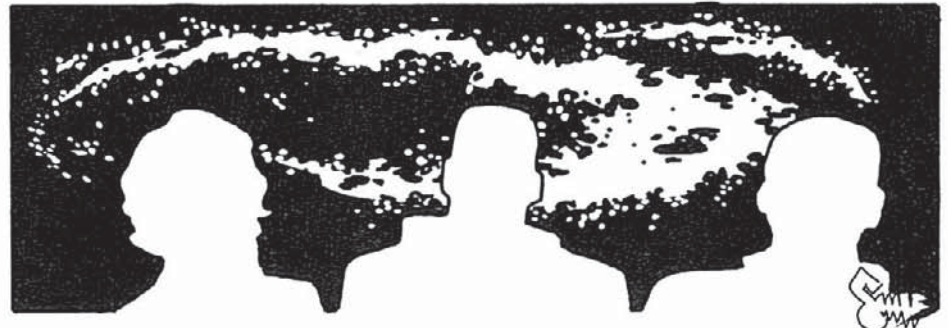

Kinnison and Nadreck undertook to overthrow the tremendous bipartite empire that ruled the Second Galaxy from Thrale and Onlo. Kinnison assassinated Alcon, the Tyrant of Thrale and assumed the Tyranny himself, only to find that the power behind the throne, Prime Minister Fossten, possessed powers equal to those of an Arisian.

Believing Fossten a mad, renegade Arisian behind all of Boskone, Kinnison engaged him in mental combat and slew him — never knowing that, with Mentor's help, he had slain Gharlane of Eddore, second only to the All-Highest. Meanwhile, Nadreck reduced Onlo (report under Lensman's Seal).

The surrender of the Thrale-Onlonian military to Port Admiral Haynes on "V-B Day" marked the end of the Boskonian War and the beginning of the first peace the Galactic Union had ever known. Kinnison married Clarrissa MacDougall, and became Coordinator of the Second Galaxy, headquartered on Klovvia. Piracy, drugs and other elements of Boskone's conspiracy continued, but were reduced by the Patrol to ordinary criminal behavior. Other problems could now be addressed.

Since the first use of atomic energy, power plants had occasionally flared out of control and spawned the horribly destructive loose atomic vortices. Finally, in the comparative tranquility following the conquest of Thrale, nucleonicist Neal Cloud of the Patrol's Vortex Control Laboratory discovered how to extinguish vortices, using his unique abilities of lightning calculation. His career as "The Vortex Blaster" took him to many stellar systems. Incidental to blowing out vortices, he was in the right place at the right time to break up a thionite manufacturing ring and to prevent a warring pair of races from using vortices to destroy each other.

An odd crew signed on with him after he saved their lives — Vesta the Vegian, Nadine of Manarka, Tommie of Tominga and the lovers Thlaskin and Maluleme of Chickladoria. With them and a team of cyberneticists trying to figure out how he did it, "Storm" Cloud blasted vortices across the galaxies.

Dr. Joan Janowick was finally able to build an electronic automatic analogue computer that could reproduce Cloud's lightning calculations. Now that Cloud was no longer indispensable as "The Vortex Blaster," Joan and Cloud set about investigating the cause of the vortices. Discussion with the Manarkan Masters of Thought led to the study of a whole domain of mental discipline distinct from the realms of the Lens, and, in turn, to contact with the pure-energy beings of Cahuita, who created vortices as incubators for their young. The Cahuitans had not realized the existence of material beings; they quickly agreed to ignite vortices only on uninhabited worlds.

By the time Kimball Kinnison's son Christopher graduated from the Patrol's Academy, the crime levels had risen sharply across the galaxies. Individual planets believed it a local phenomenon, but the Galactic Coordinator was able to see a larger pattern to the increasing rates of insanity, rioting and crime. Kimball called himself and the other Second-Stage Lensmen back into active service and placed them under the direction of young Christopher — one of the ultimate products of the Arisian breeding program and the first Tellurian inherently stable at the third level of stress.

Each of his four sisters became the guardian of one of the Second-Stage Lensmen, who set out to trace and eliminate the renewed activity. After much investigation, the outlines of the new conspiracy — the "Spawn of Boskone" — became perceptible to the Second-Stage Lensmen — a renewal of piracy, drugs and every vice, new enclaves where Overlords tortured and fed, the "Hell-Hole in Space" that drove mad all who neared it, Black Lensmen . . . and all controlled from the dread planet Floor.

The Children of the Lens, however, realized that the power structure had yet another layer. Knowing that no one other than his sisters must ever suspect even the existence of Eddore, Christopher conducted a lone strategic reconnaissance of that heavily fortified, odious planet. He escaped with vital information — whereupon the Eddorians counter-attacked Arisia itself with vast weaponry. The Kinnison children directed both the defense of Arisia and the destruction of Eddore's highest proxy-race, the Ploorans.



## ***Three Views of Women (Continued)***

Human personalities, male and female, can always be divided fairly clearly into leaders and followers, but the distinction is clearest amid the women in this type of society. Many are disconcerted by the least departure from the ordinary. "Why, I went clear to Mars! And it gave me the screaming meamies, no less — I thought I would collapse!" This sort of behavior is frequently encouraged by men who wish to avoid competition from women. Others, however, become strong in spite of their social disadvantage. The females of Mentor's breeding lines are certainly of this type: true aces, firing on all jets, ready to take on the difficult loads required of them. Not all competent, aggressive women are admirable, of course. See the *Femme Fatale* character type, p. 20.

### ***Equal***

In some societies, gender is of no importance whatsoever. Women are permitted anything men are, in fact as well as by law. It is highly unlikely that the Patrol will have this level of equality unless Mentor gives Lenses to women.

## The “Little Lady”

In sexually oppressive societies, women often are trained from childhood into the 0-point Little Lady package: they have -1 HT (from habitual corseting), -1 ST (from no exercise), hand-work skills at DX, and Empathy (“Women’s Intuition”). This package does not include Social Stigma, which is also required.

### Unnatural, Perverted Societies

Equality of the sexes is a fundamental principle of Civilization. However, many societies don’t share this ideal. In some, males ruthlessly dominate the women. Civilization and the Patrol officially disparage this practice but may tacitly condone it, depending on the level of sexism, as long as it is not too extreme. (The Kalonians’ enslavement of their women is not tolerable, for example.) In other societies women dominate the men (e.g., Lyrane II). If the Patrol is not sexist, such societies are viewed with the same distaste as women-oppressed societies, but that distaste is nothing compared to the revulsion a male-dominated Patrol would feel toward such an overturning of the natural order of things.

### Lenscritter?

When speaking English, female human Lens-wearers are called Lensmen, following the lead of the Red Lensman, as are those of all other races, many of which are even more alien than human women. The equivalent term in alien languages, which can have radically different notions of gender, is usually translated into English as “Lensed One.”

A man who “Publicly Disparages Women” will mock “Lensgirls” — until he meets one. That experience may either instill a grudging respect, or transform him into a full-fledged “Misogynist.”

Some evidence exists that Melasnikov of Kalonia mocked Cleonie of Lyrane during its training for a Black Lens by calling it a “Lenspersion,” but that construction so revolted even *its* atrophied sensibilities that it insisted on “Lensman” — much to Melasnikov’s glee.

Finally, Mentor of Arisia, who had never initiated contact with any Lensman of Civilization save only the Second-Stage Lensmen, broadcast to every wearer of the Lens an incredible request. The destruction of the Spawn of Boskone was insufficient; there remained “a residuum of non-material malignancy” that only the massed mental force of the entire Lensman Corps could remove from this plane of existence. With Mentor’s coordination and the Children’s guidance, that “evil effluvia” — all life on Eddore — was erased.

Unknown to all but the Children of the Lens, the Arisians voluntarily passed on to the next plane of existence when their work was completed, leaving the Third-Stage Lensmen as the new Guardians of Civilization. Their role is unknown to Civilization at large, and the struggle continues as the Lensmen seek out and destroy the scattered but still pernicious fragments of Boskone.

## ● WOMEN AND LENSES

Jill Samms, daughter of the First Lensman and ancestor of the Red Lensman, Clarrissa MacDougall, went to Arisia for a Lens. She returned — Lensless — and reported:

*That Arisian was a thousand times more of a woman than I ever will be, and she didn’t wear a Lens — never had worn one. Women’s minds and Lenses don’t fit. There’s a sex-based incompatibility. Lenses are as masculine as whiskers — and at that, only a very few men can ever wear them, either. Very special men, like you three and Dad and Pops Kinnison. Men with tremendous force, drive and scope. Pure killers, all of you; each in his own way, of course. No more to be stopped than a glacier, and twice as hard and ten times as cold. A woman simply can’t have that kind of a mind! There is going to be a woman Lensman some day — just one — but not for years and years and I wouldn’t be in her shoes for anything.*

Arisians did not lie, but they “have at various times made ambiguous statements, to lead certain Lensmen and others to arrive at erroneous conclusions.” This was one such time. Jill stated an implication as a fact, and the founders of the Galactic Patrol jumped to precisely the conclusion Mentor intended.

Mentor was entirely capable of creating Lenses for women — Clarrissa was not that freakish, nor are human women much more alien than, say, Palainians. It is, nonetheless, impossible for human women to be Lensmen for the simple reason that Mentor *won’t* allow it. Two — and only two — human women *ever* knowingly encountered an Arisian. Nor is it necessary for an intellect to be above precisionist grade to understand the Arisians’ reasoning.

Humans are unique among the other races of the galaxies for their sheer indomitable will. The most casual observer of the human race would note that the fullest expression of that unstoppable drive is evoked by that complex suite of emotions, love.

Human love, as analyzed by Mentor, includes but is not limited to individual affection. It includes all the higher feelings of community that the gregarious plains apes evolved . . . it includes patriotism. Boskonian propaganda sneered at patriotism, and made it *de rigueur* for self-proclaimed “intellectuals” to ridicule patriotism. However, little was needed to ensure that the majority of humanity remembered that patriotism is not sentimental nonsense. Those groups that succumbed to the pernicious idea died.

Even though no Arisian fully understood human love, Mentor realized its importance and carefully cultivated all its forms. The Boskonian propaganda was actually useful, since its inherent fallacy could be clearly and simply demonstrated again and again by allowing large portions of the human race to accept it, and teeter on the verge of extinction. The survivors would be both genetically stronger and at least temporarily less ready to forget that “women and children first” is a biological imperative.

It is a simple fact of human reproduction that a group can lose the vast majority of its males and still recover. It cannot survive the loss of any significant fraction of its female population. Never was the point so ruthlessly driven home as immediately after the Third, or Nuclear, Phase of the World War.

Both sexes are equally vulnerable to the immediate physical, *somatic* damage of radiation poisoning, and to the long-term, *chronic* effects such as leukemia and other cancers. However, women are much more vulnerable to *genetic* damage. Females are born with all the potential ova they will ever have. They are irreplaceable if damaged or destroyed. Males, though, constantly create more spermatozoa. Defective cells are re-absorbed and replaced. Thus, the implacable and politically incorrect forces of evolution mandate that *men do the dangerous work*. Human Civilization already strongly held that idea when Mentor expressly validated it: only males are expendable. “Lenses are as masculine as whiskers” exactly because the male is the first line of defense against physical danger. It may become necessary for a woman to be a hellcat in defense of what she holds dear, but if all goes well, she doesn’t *have to*.

This imperative could be and was tied to the uniquely human “drive.” *Men* fought and died to defend their families — only in times of utmost disaster did *women* take arms in defense of their homes and children. Mentor used precisely this fact in the design of the Galactic Union. Men alone did the dangerous work, placing themselves between their loved ones and the war’s desolation, until the final battle. Only then, in the utmost extremity, did a woman — the beloved Red Lensman — take to the front lines. Seeing her in danger, all human Lensmen, wherever situated, put forth their ultimate effort.

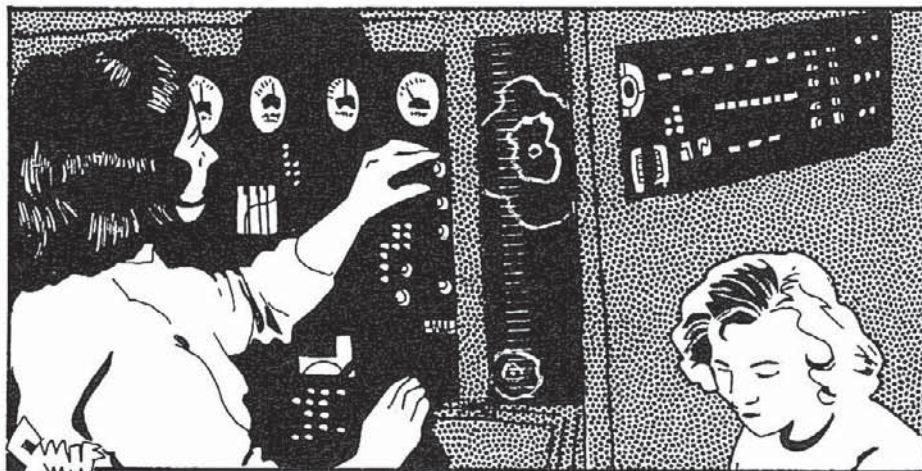

### Meanwhile, In Another Universe . . .

Doc Smith was not sexist — it is clear from his writing and published conversations that he greatly admired strong, capable women. He grew up before World War I, however, and wrote the *Lensman* series during and immediately after World War II. He firmly believed that during war, women should work on the “Home Front” while men fight the actual battles, and Mentor agreed with him. However, some GMs may prefer to contradict him and run a Galactic Patrol with more liberal policies.

Since the GM is striking out on his own in this area, any decisions are finally his, and few guidelines can be offered. One that can be suggested is that women’s equality or lack thereof in the Universe of the Lens be considered in three separate elements: Mentor’s plan, the Galactic Patrol’s policies and societies’ attitudes at large. If Mentor will create Lenses for women, then the attitude of the Galactic Patrol must be re-determined, and finally the various planets and societies of Civilization will have varying customs and laws.

The revisionist GM must first decide what Mentor’s Visualization dictates. If he chooses not to acknowledge humanity’s sexual nature at all, women can receive Lenses without restriction. A compromise possibility is that Mentor needed Clarrissa to be the *first* woman Lensman, but that after she was enLensed, others could follow. There are many other options.

The spectrum of human sexual equality can be divided into three ranges. The GM will have to decide how the Galactic Patrol and each human society in the

## Officers’ Specialties — Line and Staff Corps

The officers of the Galactic Patrol are divided into two separate corps — the Line and the Staff. Line officers are those trained to command. Their technical knowledge is broad, but not extremely detailed. Staff officers are trained in depth in a particular technical specialty, but only superficially outside that area. They may give orders to subordinates only in their particular area, such as a medical officer to his corpsmen, but can assume command only in utter catastrophes, when every line officer is killed. A line ensign will take command before a medical commodore.

It is possible to transfer from the line to staff. It is also possible, but much more difficult, to join the line from the staff.

Line officers are identified by the Golden Meteor above their rank. Staff officers have different symbols there — a caduceus for Medical, a sunburst for Engineering and so on. The Staff Corps of the Galactic Patrol comprises the Medical, Engineering, Supply, and Chaplain Corps among others.

The Marines also have specialties such as Infantry, Aviation, Military Police, Finance, etc. and their rank insignia bears an appropriate symbol, but no distinction is made between line and staff. Rather, *positions* are designated “line” or “staff,” and all officers serve in both during their careers. As platoon and company commanders, lieutenants and captains are line officers. Senior captains then all become staff officers and remain such until they reach lieutenant colonel. At that point, an officer either permanently remains on staff, or is given command of a battalion and becomes a line officer again.

The order of succession in the Marines varies with each unit’s SOP, but usually prefers line officers. For example, in Mobile Infantry brigades, if the Brigade Commander becomes a casualty, the next to command falls on the Battalion Commander Not In Contact (or Battalion Commander of the Reserve Battalion). During the next lull in battle, the Senior Battalion Commander assumes command. However, if a Battalion Commander is killed, his operations officer (a staff position) assumes command.

## The Oath

"I, [broadcast your identifying symbol]  
...  
"... being legally competent to enter into contract and of my own free will ...  
"... do now enlist in the Galactic Patrol ...  
"... for a term of not less than three Standard years ...  
"... and as much longer as may be required by the needs of the Patrol.  
"I promise before the Omnipotent Witness ...  
"... to uphold and defend the Articles of Galactic Unity against all enemies wherever situate ...  
"... to protect and defend the conferred liberties and privileges of all adherents ...  
"... to perform such duties of lawful nature as may be assigned to me by lawful authority ...  
"... and to obey all lawful orders of the Commander-in-Chief of the Galactic Patrol ...  
"... and of all officers or delegated beings placed over me ...  
"... and to require such obedience from all members of the Patrol ...  
"... or other beings lawfully placed under my orders."



Galactic Union handles inter-sexual relationships. Civilization is not monolithic — the attitudes of Valerians may be quite different from those of Alsakanites. In general, subsistence societies on a frontier can't afford to arbitrarily discriminate by sex — there's too much work to do. More profitable cultures have more leisure time to spare making up restrictions and can tolerate the loss of half their work force.

Note that regardless of the level of women's liberty, no *man* would ever publicly humiliate or even be impolite to a woman. "Publicly Disparages Women" is a -5 point Odious Personal Habit anywhere in Civilization, and any *man* would be strongly tempted to take such a boor out back and teach him some manners. Out-and-out "Misogynist" is a -10-point OPH/Intolerance. True *men* are *benevolent* dictators, putting women on pedestals. They will always open doors, carry packages, and so on. Those from the more oppressive societies will be amused by any capable woman's "pluck" and "feistiness," and may quite firmly block her efforts. They really are very (disgustingly patronizingly) concerned for her safety, though, and are honestly doing it for what they think is her own good.

## ◎ THE ACADEMY

Nearly every society that makes up the Galactic Union has some form of armed force. To weld those wildly disparate organizations into a functional whole would be starkly impossible. Accordingly, the Galactic Council authorized the formation of an inter-world military: the Galactic Patrol.

Each society has its own means of identifying, qualifying and training its officer candidates. Humanity, following Tellurian tradition, uses both Officer Candidate Schools and an Academy system.

A human enlisted man, depending on aptitude and chosen specialty, is trained on duty or at any of a vast number of schools. For an officer to be effective, however, he needs a much broader base of knowledge and leadership skills, which are rarely taught in civilian life. Accordingly, each year, out of the millions of millions of humans who apply throughout the galaxies, one million men are chosen to attend the Tellurian Academy. Preference is given to enlisted men with proven service, but anyone considered competent to enter into a contract by his society will be considered.

The Academy is fantastically grueling, with a 95% attrition rate the first year and 98% the second. Those who fail become senior (Rank 2) NCOs. Completion of three years at Academy earns a commission as a third lieutenant in the Force or a midshipman in the Patrol for around nine hundred of the thousand remaining. Three months after reporting to the first command, promotion is all but automatic to second lieutenant or ensign, and the officer's career is underway.

About 150 special individuals are invited to Wentworth Hall after the three-year term. Those men receive another year of training. Few are dropped — culling this elite would be a formidable task — but about a third of the class will not survive their fifth year. During that year, they go on a tour of active duty (as third lieutenant or midshipman) including significant contact with enemy forces and a trip to Arisia. (That some of the losses are men that do not return from Arisia is a highly-classified fact. They are officially recorded as lost in honorable action.) Those that survive receive their Lens at the end of that year and a commission as a first lieutenant or lieutenant, junior grade.

It should be noted that a Lens supersedes all time in grade. In other words, a lieutenant who was promoted a year ago usually outranks one just promoted a month ago. However, if the new lieutenant is a Lensman, he outranks any non-Lensed lieutenants, regardless of seniority. A non-Lensed captain would still outrank the Lensman lieutenant, though.

## ◎ SCALES OF MENTAL PROWESS

Mentor's criteria for Lensmanship include many aspects of mental strength. Other scales of intellectual power are also useful. The Galactic Library of Science uses a rating system on which the Second-Stage Lensmen rank around 800 — exact

details are available from the Library. The Manarkan Masters of Thought rank mentalities on a hierarchy of telepathic ability, on which all natural telepaths are at least Type One, all Intuitive Mathematicians (p. 28) are at least Type Threes and no First-or Second-Stage Lensman is above a Five.

It must be emphasized that these scales are unrelated — they measure different qualities. Mentor’s criteria are the broadest, including ethical metrics as well as stability and drive. Since the Library of Science’s scale was designed by humans, some fairly strong biases are inherent in it. For a single example, it weighs drive more than stability, so “aggressive” races like humanity and Velantians score higher than “thoughtful” races such as Palainians and Rigellians. The Manarkans’ is one of the narrowest, being concerned only with mental ability — penetration, range, flexibility and scope.

## ◎ THE GALACTIC UNION

The President of the Galactic Council presides over a cabinet of councillors from the various stellar systems, each authorized to induct their citizens into the Galactic Patrol.

The President appoints the Port Admiral of the Galactic Patrol. The Admirals of the various Galactic or Nebular Regions are assisted by Lieutenant-Admirals and report to their Galactic or Nebular Coordinators, who assist the Port Admiral. Under those Regional Commanders, the Marshals of each stellar system and Lieutenant-M Marshals of each inhabited planet in turn command a General and a Lieutenant-General of each society’s military forces.

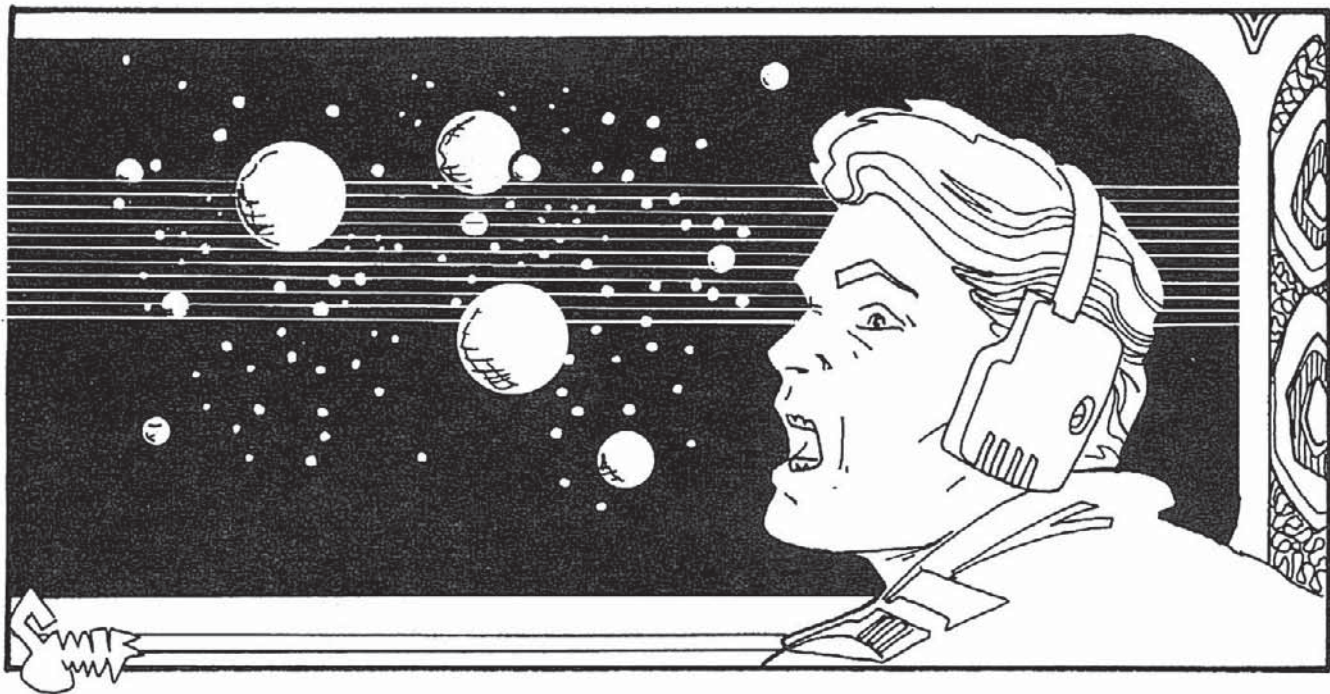

### Predecessors

The Galactic Patrol is a direct descendant of several previous organizations.

#### *The Triplanetary League*

The more forward-thinking individuals of Venus, Tellus and Mars were already working toward the formation of an Interplanetary League when the First Jovian War broke out. The Jovian Wars (which totaled four) caused the three planets to band together in an alliance that eventually became the Triplanetary League. The League was led by its Council, and the combined militaries of the three planets made up the Triplanetary Patrol. Separate from the Patrol was the secret Triplanetary Service, headed by Virgil Samms.

### Recognition

During the Boskone War, Galactic Patrol ships of space and aerospace craft are sometimes misidentified and lost to friendly fire. To correct this problem the Patrol issues the monthly journal *G.P. Journal of Recognition* to all combat forces. Its purpose is to help the fighting men learn to distinguish enemy hardware from their own. Each issue is filled with photographs, including a “pin-up” of the month featuring a new spaceship, aerospace craft or armored fighting vehicle, and brief news stories focusing on dramatic accounts of fatal errors of identification.

*Teardrop shape with chisel prow,  
Five antennas on the bow:  
Charge the beams and let ‘em rip!  
That’s a Boskone BATTLESHIP!!!*  
—Recognition Training Jingle

### *Klono’s Anatomy*

Klono exists to provide spacemen with a source of oaths, and his multitude of body parts serves that function superbly.

Space prohibits a full discussion of Klono’s complex bodily aspect, but even a preliminary survey must note his brazen hooves, tendons and whiskers, diamond-tipped horns, tungsten teeth, golden gills and grin, gadolinium guts, iridium intestines, emerald-filled gizzard, and curving carballoy claws.

## The Firsts

The first Tellurian Lensmen were Virgil Samms, Roderick and Jack Kinnison, Mason Northrop, Conway Costigan, Frederick Rodebush, Lyman Cleveland, Nels Bergenholm, Alexander Clayton and Admiral Schweikert. Knobos was the first Lensman of Mars, Dr. DalNalten of Venus, Dronvire of Rigel IV, Rularion of North Polar Jupiter, Corander of Petrine and Worsel of Velantia.

The first staffing of the Galactic Patrol was:

President of the Galactic Council: First Lensman Virgil Samms

Port Admiral: Admiral Roderick K. Kinnison

Admiral of the First Galactic Region: Commodore Clayton

Lieutenant-Admiral, GALREGONE: Commodore Schweikert

Planetary Generals:

Guindlos of Mars

Sesseffsen of Venus

Raymond of the Jovian Sub-System

Newman of Alphacent

Walters of Sirius

vanMeeter of Valeria

Adams of Procyon

Roberts of Altair

Bartell of Fomalhaut

Armand of Vega

Coigne of Aldebaran



## The Solarian League

After the Jovians were defeated and Jupiter brought under the governance of the Triplanetary Council, that body changed its name and charter, becoming the Solarian Council. The Triplanetary Patrol and Service likewise grew into the Solarian Patrol and Service. Contact with Nevians, the Palainian colony on Pluto and Rigellians made it clear that the League and Patrol would soon be interstellar in provenance, and the name changed again, to the Galactic Patrol and Galactic Union. The Solarian Service broke the pattern, becoming simply the Secret Service.

## The Enemies

Before they became aware that a single evil plot was in action to destroy Civilization, the Galactic Patrol divided their enemies into categories, each with an Operation to oppose them. The Operations had otherwise-meaningless code names: "Mateese" was corrupt politics, "Zwilnik" was drugs and vice, "Boskone" was pirates, and "Zabriska" was "some peculiar disturbances in the sub-ether."

The subetheric disturbances turned out to be drug-runner signals, and Operation Zabriska merged into Zwilnik. Operation Mateese officially ended with the indictments of Jim Towne, Senator Morgan and President Witherspoon, and all of its resources were assigned to Boskone, since that political machine turned out to be a puppet of the pirate forces. Zwilnik broadened so much as drugs permeated society that "zwilnik" became a common term of contempt for any drug-related criminal, and Boskone became a general term for the enemy conspiracy.

## Boskone's Organization

Boskone believed in parallel structures. Although not always shown on this diagram, parallel observers monitored all critical positions in the Boskonian control structure. Not connected to the operational center in any way, they reported to higher levels if the primary position were knocked out.

It must be emphasized that this chart is far from complete or conclusive. The Boskonian hierarchy *emphasized* multi-leveled complexity and redundant lines of cross-checking control. Merely three-dimensional minds find the power structures developed and maintained by the Ploorans, the Onlonians or the Eich — to say nothing of the Eddorians, alien to our very continuum — incomprehensible. To attempt to fully map those networks in a two-dimensional medium is stark folly.

## ◎ THE HOME FRONT

"The Home Front" is an accurate description for the civilians of the Galactic Union throughout most of its history. Since the earliest days of the Triplanetary League, Civilization has been locked in combat. For many generations, they did not comprehend the sheer immensity of the foe. They fought the Jovians, the heavily armed zwilniks, another small war against the Nevians and endless "police actions" against pirates until, after discovering Helmut's Grand Base, they began to grasp the true scope of Boskone, and moved completely to a full-scale war footing.

## Societies

The societies that make up the Galactic Union are infinitely varied.

The most common form of human government comprises an elected planetary assembly or assemblies, with an executive officer in the person of a president or prime minister. Local constabularies provide law enforcement, but the judiciary is often handled by the Galactic Patrol assigned to the planet, as are all military matters.

There are several oligarchies, and some royal systems, though these are less common. Anarchy is non-existent in Civilization, as the Patrol enforces Civilization's laws even if none previously existed on the planet. Likewise, very few planets do not have a planetary governing body. Internecine squabbles are distasteful, at best, to the local representatives of the Patrol, and these are quelled

quickly. The various communistic systems, such as Marxism, refuse to die out completely, but few humans take any of them seriously.

On a few Tellus-type planets, the reptilian evolutionary stage survived and developed intelligence. Those races tend to be less gregarious than mammalian ones, and less likely to develop complex governments. Velantian government is vaguely technocratic, but allows individuals to withdraw from the community to various extents. The Velantian military, though, is powerful and well organized. Their centuries of intra-system space flight have created a sophisticated Orbital Guard, and the dominion of the Overlords has instilled a racial obsession with *killing* any enemy before such a thing can happen again.

The Rigellian race evolved from a herd animal, and that heritage is quite apparent in their society. They instinctively place society's needs above their own desires. Rigellian children are always born and raised as triplets, called "unit-clusters." If one child dies, the parents immediately (and rather frantically) search for a replacement to adopt. If one is not quickly found, the two survivors are split up and offered for adoptions. Children not part of a unit-cluster are considered quite unnatural and perverse.

Palainians are unique in having evolved intelligence to *evade* predators. Their makeup orients strongly toward avoidance, misdirection and individual survival. They are completely egalitarian in a reverse sense — they have little concern for anybody else, indiscriminately. They are pacifists in the sense that they will go to any lengths to avoid personal danger or trouble.

### **Patriotism**

In times of war, humans generally rally against the enemy. Only on those rare occasions when the war is seen as immoral or illegal will the citizenry protest. The war against Boskone is unparalleled in the history of Civilization in its unifying effect on its constituent peoples, and the prestige of the military is such that there is no need for human societies to conscript for soldiers. Volunteerism is sufficient to fill all billets.

Velantians do not feel "patriotism" the way humans do; they find love of abstractions like nations inexplicable. They do, however, fully appreciate the value of "peace through superior firepower," and Velantians seem to have a (to humans, almost childish) love of weaponry and combat. Their military is always well-manned.

A strong sense of patriotism is an inseparable part of the Rigellian communist nature. Those who are strong or aggressive or have a useful talent will volunteer as soon as they become aware of the need.

Palainians have great difficulty understanding patriotism. Individual survival is much more important to them than any higher good. In times of widespread danger, those who cannot flee immediately will team up to fight the hazard together, but any one individual will only remain while he himself perceives no escape, or is coerced by an even greater threat.

### **Sex Roles**

Unemployment is virtually unknown in Civilization, in the sense that all those seeking jobs will find one in a few weeks at most. The economies of the various planets are stable, leading to strong job security. The population of workers is also fairly stable. The war with Boskone causes enough attrition that there is little pressure on the job market from entry-level employees seeking swift advancement.

Styles of work, on the other hand, vary with local planetary traditions, mores and preferences, though a more homogeneous working environment is developing as the war disperses beings across the galaxies, and space travel becomes universally available.

Equality of all sexes and races is a fundamental principle of the Galactic Union. That human women are prohibited from serving in combat positions in the military forces is the only exception to complete equality of opportunity *under the law*. In practice, however, many sexual distinctions remain.



### **Taxes**

Taxes are quite low in Civilization. With broad trade and shipping, and space travel relatively safe, inflation remains low and the standard of living high. The Galactic Coordinators, who are Lensmen and therefore incorruptible, oversee the running of the entire galaxy. Their bureaucracy is small and efficient.

The various planets may tax their population as well. The Patrol's representative on the planet reviews the taxation and budgets proposed by the planetary government, and will turn down any usurious proposals.

Because Velantian society allows individuals to secede to nearly any extent they desire, taxes are impossible to collect. Rather, government projects are either started on speculation and paid for by tolls during use (school, for example), or are financed by contributions (most military expenditures).

Taxes are meaningless when property is communally owned. Rigellian history includes the payment of *tribute* from one herd to another, and Rigel as a planet pays taxes to the Galactic Union, but the concept of taxation is an esoteric one to Rigellians.

On occasion, a group of Palainians will temporarily band together for some specific purpose, and ask for others' support. Their request can be more or less forceful, ranging from something analogous to a charity's call for donations to something resembling outright extortion. A continuing tax is impractical, however, since every individual would need to be continually intimidated and restrained from simply leaving.



## Sexual Mores

Human sexual mores have changed little for many centuries. Despite legal equality, many societal double standards continue. Pre-or extra-marital sex is both illegal and socially forbidden to both sexes, but a promiscuous man will face little sanction and may be somewhat envied, while a “loose” woman will be shamed and shunned forever.

While most human societies forbid sex outside marriage (the Aldebaranians being a notable exception), flirtation is a common pastime. The teasing girl is constantly warned by her more cautious friends of the “danger” she is in, and the Patrolman with “a girl on every planet” is a common archetype. Nonetheless, the only respectable relationships for humans are serially monogamous.

Sex does not play a significant role in daily Velantian life. Their mores concern maximizing individual freedoms without interference. Feuds are common in Velantian history, and rather elaborate rituals have developed to avoid them.

Rigellian morality is easy to superficially define: the needs of the many outweigh the needs of the few or the one. This fascist ideal is revolting to many humans and most Velantians, but its implications and complications make up most of Rigellian philosophy and literature. Rigellians take few actions without considering their effects on larger society. They especially do not start any sexual involvement without discussion with their leaders.

Selfishness, cowardice and slyness are the most admired qualities of Palainian society. Ignore and be ignored is the Prime Tenet. Those principles guide all interactions, including the emmfozial. If an individual can force another to be emmfozially faithful, he will. If one can be promiscuous, he will.

Distinctions between “blue collar” manual work and “white collar” jobs still exist. “Blue collar” workers typically learn their trade through apprenticeship, and associate with co-workers in unions and guilds. “White collar” professions are seldom learned “hands-on”; most such jobs require education if not actual degrees. Within a career, advancement is sometimes controlled by formal professional associations, but more often by informal “old-boys networks.”

All human males work. The few exceptions are looked down upon; whether they are independently wealthy or hoboes, they are outsiders and somehow not *men*. Human women *often* work but there is no requirement, implicit or otherwise, that they do so.

In lower economic brackets, a wife usually must work to make ends meet. She will usually wind up in a “blue-collar” job, often in the manufacturing sector — another “Rosie the Riveter.”

At the other extreme, the very rich and powerful have many options. If a woman from the upper classes wants to work, she does so, and any comments will pertain more to her success or failure than her sex. No stigma is attached to a woman of this class who works. Gladys Forrester is a typical example — a woman with distinct advantages but still quite successful in her own right, remarkable but not astounding.

The women of the lower reaches of the middle class usually delay going to work until their children are in school, and then often work at that school as general assistants and substitute teachers, taking much of their pay in the form of reduced tuitions.

It is in the upper middle class that the stereotypical “housewife” is found. In these families, the husband’s pay is enough that the wife doesn’t *need* to work. Occasionally, if she has attended a prestigious woman’s college or a respected business school, she may take a “pink-collar” job as an executive secretary or other high-ranking assistant’s job.

Velantian females’ place in their society is as different as their biologies. They lay several clutches of eggs a year; if they have been fertilized and are protected, about a dozen infants will hatch a few months later.

The role of a Velantian female is based almost exclusively on whether she has bred. Until she has produced a viable clutch, her choices are limited, and have been compared to a human woman’s in ancient England during Queen Victoria’s reign. After she has bred, her options are as unlimited as a male’s. Females make up about 40% of all Velantian armed forces, and over 60% of the Orbital Guard.

Rigellians chose their sex at puberty, becoming male, female or neuter. Society places tremendous pressure on adolescent unit-clusters to choose a particular set of sexes — exactly which changes from time to time. During the Boskonian War, the ideal unit-cluster became two males and one female.

Palainian society, such as it is, takes no notice of sex. Any of the sexes can be found in any occupation, allowing for a *one*’s immobility, of course.

It should be noted that the vast majority of humanoid races habitually go naked or nearly so.

## Law Enforcement

The Galactic Union has very few laws of its own; it instead adopts the non-conflicting laws of its constituents. It does enforce some regulations intended to limit cross-cultural trouble. Any form of deliberate interference in local affairs can be charged as a crime. For example, societies are rated in terms of Tech Stages, with zero

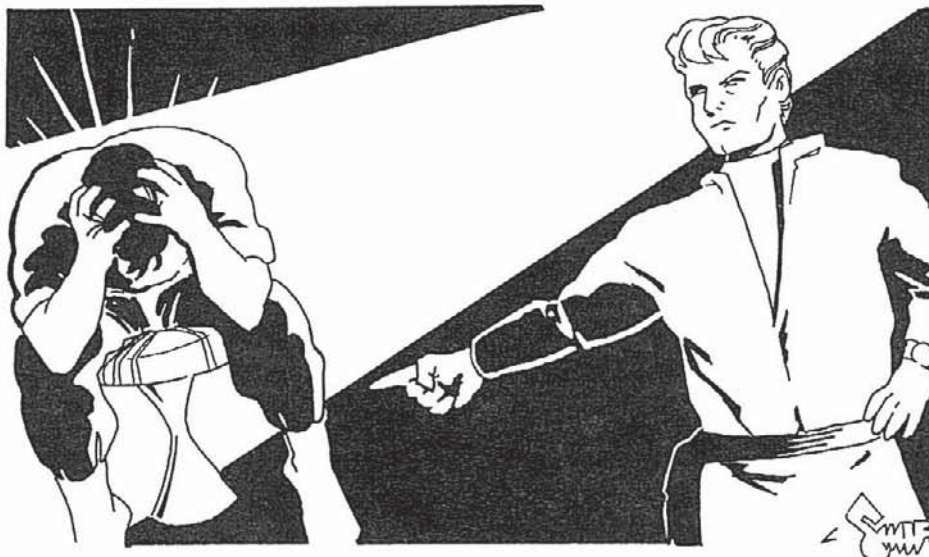

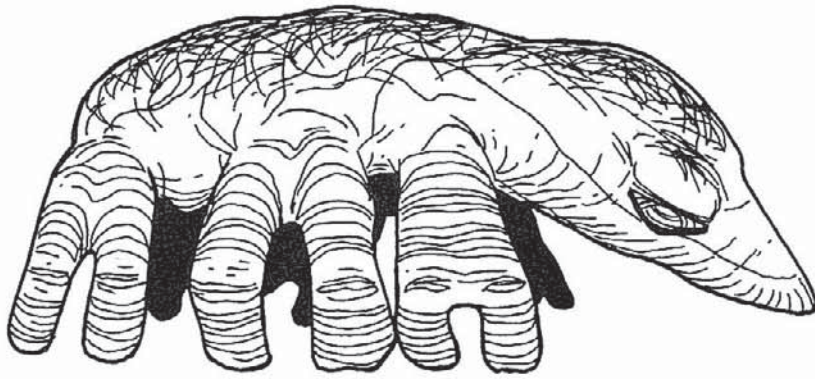

SMIF

defined as humanity's capabilities just after the Third Phase of the World War, and ten being the Union's level at the end of the Boskonian War. Revealing higher Stage technology to a lower Stage society is a Galactic felony, punishable by an extensive prison term and possibly mental adjustment.

The Velantian love of individual freedom has kept formal law enforcement to a minimum in their societies. The Velantian love of violence makes a criminal's life quite exciting and usually fairly short.

The Rigellian herd-mentality has difficulty understanding "legality." To them, an act is either beneficial to society, in which case it is rewarded of course, or it is harmful, and that individual is either educated as to his mistake and makes restitution, or is insane and is eliminated. They have no need for an explicit mechanism to do so. That the good of the many is of utmost important is genetically encoded in Rigellians.

Palainians do not understand the idea of law any more than they do patriotism. To a human, their furtive and selfish natures make them all seem criminal. They have concepts related to crime — a Palainian considers any action that endangers himself to be offensive, but the offended one will react on his own, either eliminating the offender or simply leaving the situation. The idea of appealing to a higher authority for redress is laughable. No Palainian would interfere unless he could profit from it, without danger.

Human law enforcement is much more complex. The actual *enforcement* process is similar to previous eras, though the *judicial* system is very different.

An ideal judicial system discovers the truth while protecting the rights of the accused until and unless his guilt is determined. Throughout history, this ideal was approachable, but ultimately unattainable, until the instrumentality of the Lens became available.

As it became clear that Lensmen were incorruptible, *not* to have a Lensman witness became a strong piece of circumstantial evidence. After *North America v. Gilson*, during which Lensman Captain Maynard contacted "Bobcat" Gilson's mind and immediately shot him dead, the courts gave up instructing juries that they could not consider the refusal of the defendant to be mind-read to be an admission of guilt. Soon, the entire jury system withered away.

Now, an accused may be absolutely innocent of the charges brought against him, but found guilty of worse, previously undetected crimes. This situation has resulted in beings charged with traffic offenses being sentenced to the lethal chambers (the classic example being *Solarian Union v. Ossman*, where the accused was arrested for littering in a National Forest and executed for multiple counts of trafficking in controlled substances). This efficiency is only possible because of the confidence placed in a Lensed judge.

It should also be noted that less than a thousand Lensed judges are required on Tellus at any one time. The reliable, swift, final and extreme penalties for serious crimes have reduced the number of cases to be tried to a infinitesimal fraction of the glut experienced by the Triplanetary League.

## Dissent

While no world that ever voted to join the Galactic Union has ever seceded, dissent and protest movements are found everywhere. It is universally accepted that freedom for humans requires the privilege of some individual expression, and the Galactic Council prefers to err on the side of license. Hence, several organizations advocating the overthrow of Civilization itself remain active.

Civil disobedience is a highly acclaimed art in Velantian society. To agree with a large number of others is seen as a weakness. Intellectual debate is a popular sport, especially in its aerial, full-contact forms.

To a Rigellian, the majority is always absolutely right. Discontent is neurotic and active dissent is, by definition, insanity.

"Dissent" is meaningless in Palainian society. One can try to persuade another to do his bidding, or one can force another (and to a Palainian, the latter is but a more vigorous version of the former), but the idea of an expected "duty" is all but incomprehensible. A Palainian who disagrees with the majority's course of action simply ignores it.

## Religion

Many Tellurian religions survived contact with alien cultures, and many alien religions found new converts from Tellus. Valeria's Noshabkeming and Corvina II's Klono are popular among men of space (Klono more frequently as a joke than as a serious deity). Some Venerians worship Grolossen and Great Kalastho is invoked by Chickladorians, while Vegians celebrate Zevz, Tlazz and Jadjkptn.

An incredibly variety of divinity and transcendental philosophies have flourished in Velantian society. Every Velantian feels that he *ought* to develop and express his own ideas, but feels no requirement to accept anyone else's — in fact, they seem to feel that they should attack everyone else's.

Details vary, but Rigellian concepts of divinity are akin to the human *nirvana*, a sort of blissful selfless melding with infinity.

Something akin to religion exists in Palainian philosophic thought, but is even more inexplicable than human rites. Research is ongoing, but concepts such as those tentatively translated as "transcendental housework" and "technical poetry" are elusive of comprehension.

# CHARACTERS



## ● CHARACTER POINTS

The Universe of the Lens is a dangerous place. It is certainly not necessary to be a Lensman or even a Galactic Patrolman to encounter mind-numbing danger — but it helps. A lot. Lensmen are very competent, highly trained, and well-equipped characters, well above the standard *GURPS* 100 points.

Not all characters need be Lensmen. NonLensed Galactic Patrolmen with the esoteric knowledge or skills necessary for a particular mission will be included in operations. Since they do not have to meet the rigid standards of a Lensman, they can be much quirkier and perhaps more interesting to play.

However, it is certainly not the case that all Lensmen are cut from the same Boy Scout stereotype. Granted, nearly all those mental disadvantages not required are forbidden, but that simply means that a Lensman will have to be detailed, rather than painted with a broad brush. Rather being conceived in terms of the high-value disadvantages (resulting in drug-addicted, pyromaniac, compulsive liars), Lensmen characters must rely on quirks to individualize them.

The standard limit of 40 points in disadvantages must be modified in the case of Lensmen to allow them to meet the stiff requirements of the Lens. A Lensman must have Code of Honor, Enemy (Boskonian), Duty, Honesty and Sense of Duty; these do not count against the 40-point limit.

### 100 Points — “Citizen of the Galaxy”

Civilization is made up of ordinary people. While ordinary people do not become Lensmen, they may well encounter great dangers. A war waged for the minds and souls of every sapient being, in which entire planets are expendable, will all-too-frequently involve civilians. Everyone has a chance for epic adventure. There are no “fronts” in an interstellar war. Characters previously uninvolved in the conflict may awake to find their planet captured by the enemy; they are involved, willy-nilly, in partisan activities.

## ● CHARACTER TYPES

Civilization is made up of a great many different races, some very different from humanity. The professions listed here are common among human-like cultures; non-humans will have appropriately alien occupations.

Some races accentuate their sexual differences, forbidding some occupations to some sexes. Lyranians are an example of extreme differentiation; Velantians have almost none. In some races, some of these examples are restricted to one or some sexes, but no general rule is possible. Anyone discussing these matters with a member of an unfamiliar race is cautioned against giving offense.

### **Ambassador/Diplomat**

The heterogeneous nature of Civilization provides plenty of work for ambassadors and other diplomats who negotiate

### 200 Points — “Galactic Patrolman”

The majority of the Galactic Patrol is not Lensed, but consists of duty military personnel like those of any previous time-period. Because they are much more likely to come into direct conflict with the forces menacing Civilization, they are much better equipped and trained than ordinary civilians.

### 400 Points — “Lieutenant Lensman”

A character meeting the requirements of the Lens is a valuable asset to Civilization, and need only enlist in the Galactic Patrol to soon find Mentor charging him with the honor and interests of Civilization itself.

### 1,000 Points — “Unattached”

The instrumentality of the Lens allowed the creation of a military rank never before possible. An Unattached Lensman has demonstrated to the Galactic Patrol that his own Sense of Duty is stronger than the externally imposed Duty of the Patrol, and his Lens proves that his Code of Honor — his conscience — symbolized by the Gray Seal will require him to work always for the good of Civilization. He has therefore been “Released” from the chain of command. He is no longer a part of the vast organization of the Galactic Patrol; he *is* the Galactic Patrol!

### “Guardians of Civilization”

Only five intellects of the second level of development actually received “second-stage” training, but complements for Tregonsee, Worsel and Nadreck were developed. These ten individuals were in constant, direct conflict with the most powerful of Civilization’s nemeses. Similarly, while only the first five Intellects of the Third Level of Development are described in the published history of Civilization, it is certain that others exist. The Guardian’s Message of Transmittal states that “you, the third-level intellect . . . able to break the Seal and to read this tape . . . will do that for which you shall have been developed and are to be trained.” Understanding of that task is so mind-shattering as to immediately annihilate any intellect of lower stability. Therefore, it shall not be discussed further in this medium.

alliances, trade agreements, and mutual defense treaties. As famous, influential and important members of their societies, they are targets to their enemies.

*Advantages:* Charisma, Danger Sense, Empathy, Intuition, Language Talent, Reputation, Status 4+ and Voice.

*Disadvantages:* Cowardice is easily hidden. Truthfulness is crippling.

*Skills:* Diplomacy, Acting, Bard, Detect Lies and any social skills for dealing with people. Heraldry, History, any Language (often several), Area Knowledge and Law will help in dealing with foreigners. Strategy, Holdout, Escape and combat skills are useful in case diplomatic negotiations become hostile.

## **Bureaucrat**

As in many previous times, the civil service holds a lot of power behind the scenes. They know how the government *really* runs, and accumulate wealth and power while the transitory politicians come and go.

Bureaucrats might occasionally leave their offices to conduct investigations. Former military men, for instance, would like to see things themselves. Some civil servants are charged with supervising and policing government contractors, making sure that government funds are not misappropriated or mispent. Lensmen are seldom available for the initial phases of an investigation, so a functionary and his staff are likely to be the first to discover a conspiracy within the very bastions of the military-industrial complex!

*Advantages:* Comfortable or higher Wealth and some Status is common. A Patron, usually someone higher in the service, is helpful.

*Disadvantages:* Addiction, Compulsive Behavior, Dependents, Duty (to the local government) and Miserliness. Cowardice and Greed would fit the stereotype.

*Skills:* Accounting, Administration, Detect Lies, Fast-Talk, History, Law, Mathematics, Politics, Research and Social skills are all useful.

## **Engineer**

If a scientist (p. 23) is a cloistered monk, rarely seen outside his ivory tower, an engineer is the lay preacher who spreads the word through the people. He creates the practical application of new technology. Engineers are often the golden boys of their organization, well fed and well paid both to prevent their defection elsewhere and quite simply as a reward for their productivity. Engineers specialize; some areas useful to players include physics (atomic, inertialess, hyper-space . . .), electronics, chemistry (explosives) and so on. Engineers should be inventive.

*Advantages:* Reasonable choices would be Mathematical Ability, Lightning Calculator and Eidetic Memory. Good engineers will also have a Reputation in their specialty.

*Disadvantages:* An engineer has no physical requirements, so a physical disadvantage will not restrict his part in the game. Some mental disadvantages that would disqualify him from military service are also appropriate.

*Skills:* Depending on the character's specialty, possible skills include Integrating Calculator Operation, Electronics (various), Electronics Operation (various), Engineer (various), Mathematics, Mechanic (Integrating Calculator), Metallurgy, and Physics (Atomic), (Hyperspace) or (Inertialess).

## **Entertainer**

The media are a pervasive part of Civilization. Actors, singers, dancers, performers of all sorts are popular and frequently tour the galaxies with a show. Lensmen and other agents frequently use media figures as cover identities.

*Advantages:* A pleasant Appearance and Voice may help, although they are not necessary. Charisma is. Empathy and a Patron would help any performer. Absolute Timing and of course Musical Ability are good for musicians. Reputation, Status and Wealth follow success.

*Disadvantages:* Addictions or Alcoholism are occupational

hazards. Nearly all mental disadvantages can be found in successful stars.

*Skills:* Artistic skills, obviously. Carousing, Savoir-Faire and Sex Appeal are very helpful.



## **Femme Fatale**

*"You could think of other places that would be more fun." She got up and stared directly into his eyes, her lip curling. "That is, if you were a man instead of a sublimated Boy Scout."*

A favorite technique of the Boskonian intelligence agencies is that of the sexual "honey trap." The exotic wives of a promiscuous Aldebaranian beauty have ensnared more than one Galactic Patrolman. (Lensmen are made of stern enough stuff to resist, though they may be sorely tempted.)

The *femme fatale* is always adventurous and always enchantingly beautiful, an enemy agent who works by seduction. She represents the ultimate player in the game of emotional manipulation. Femmes fatale have been used in espionage since spying first became a profession.

She can serve as an effective spy in her own right, charming her way into forbidden places or inveigling secrets out of unwary men. Furthermore, she can create an endless number of new spies. Her more ardent lovers may willingly become her agents. Others find themselves vulnerable to blackmail. Her charm allows her to be the most brazen of spies. She may directly proposition enemy politicians or she may steal documents from beneath the very noses of their custodians. To an enemy entranced by her beauty, the *femme fatale's* boldness seems proof that she could not be a secret agent.

However, the true *femme fatale* is far more than simply another kind of spy. She is a woman of passion and mystery. Should times grow dull, she will risk anything to regain a life of intrigue. Indeed, it is probably her thirst for romance that first led her into her shadowy career.

From a coldly practical point of view, the *femme fatale* is an unreliable agent. She takes risks. She allows her emotions to rule her. She is obvious. Her controllers cannot ignore the danger of her being captured or turned, and as a matter of course make preparations to neutralize her. In typical Boskonian fashion, those steps are usually fatal or utterly destructive to her mind.

As a final note, the femme fatale need not be a female. As women take positions of authority and power on the Home Front, masculine spies may find their services in demand. Furthermore, a seducer of powerful men's wives could be a spy in the most chauvinistic times and places.

*Advantages:* Beautiful or better Appearance and Charisma are essential. Acute Hearing, Eidetic Memory, Empathy and Intuition are useful. She may acquire Patrons, Wealth and a Reputation.

*Disadvantages:* Addictions, Alcoholism, Compulsive Lying, Cowardice, Greed and Jealousy are appropriate. Lecherousness is practically required. Enemies will accumulate.

*Skills:* Acting, Carousing, Detect Lies, Fast-Talk, Languages, Professional Skill: Erotic Arts, Savoir-Faire and Sex Appeal are certainties. Forgery, Gambling, Lip Reading, Performance and any Artistic skills will also be helpful.

### **Galactic Patrolman**

Only exceptional people (both physically and mentally), screened according to strict standards and highly trained, can serve in the Patrol. They are at the peak of physical fitness, highly trained and self-disciplined, with a firm grasp of engineering and space flight. It is quite possible for a human woman to be a Patrolman, although she is prohibited from serving in combat positions.

The Patrol has defended and expanded Civilization for hundreds of years, and Patrolmen have much in common with the members of any previous military. Most archetypal characters from war movies can be found in it — the naive country boy seeing new worlds, the tough, cynical sergeant, the idealistic officer . . . or GMs and players could draw on the different experience of the Viet Nam war and explore the dark side of warfare. The Boskonian War has no equivalent of the Geneva Conventions of ancient Tellus. It is a war of extermination and genocide. Both sides employ any means necessary to attain their goals, including outright torture.

Note, too, that not all soldiers or spacemen are part of the Galactic Union. Many societies have waged war against Boskonian alone. Those warriors may be just as competent and heroic as those of Civilization.

*Advantages:* Military Rank and Status go hand in hand with military service. Acceleration Tolerance, Acute Vision, Combat Reflexes, Peripheral Vision, Reputation and Strong Will are possible.

*Disadvantages:* No Patrolman may have the disadvantages of Berserk, Severe Delusions or Pacifism. If he has any illegal Addiction or Alcoholism at -20, he must keep it a Secret, as well. Such a Secret is worth -10 for Alcoholism, up to -30 for Addicted to Thionite. They must accept the disadvantage of Duty (quite often or more). The elite nature of the services may lead to Bad Temper, Patrolman's Code of Honor, Fanaticism, Impulsiveness, Intolerance (of civilians or other services) or Overconfidence. A Sense of Duty to comrades, home world or Civilization itself is also appropriate. Young privates and spacemen may be Honest and Gullible, while more hardened veterans may have Bad Temper, Bloodlust or Bully.

*Skills:* Military personnel must have certain minimum skills to graduate from training into active duty. Enlisted personnel go through basic training and specialty schools, Officer

Candidate School (OCS) prepares those with college degrees or enlisted experience for commissioning and the Academy provides both the engineering college degree and the military training for particularly able applicants. All of these paths produce characters with a wide range of significant skills.

Enlisted training tends to be more specialized than officers'. For example, within a ship's Engineering Department, one enlisted division will maintain and operate the Bergenholm drives, while another will be responsible for the ship's internal electrical power system. Their training will overlap only at the most general level. Enlisted characters, therefore, should be quite experienced (skills of at least 15) in their fairly narrow chosen specialty. They are experts with their particular weapons, with high levels of Beam Weapons, Battlesuit, Space-Axe, Brawling and similar deadly skills and also in the theory, operation, maintenance and repair of their equipment. All have a basic level of skill (12 or so) in a broader set of basic skills, such as Free Fall, Vacc Suit and so on. The GM should review all character designs and insist on any minimum abilities he feels that the military would require.

Civilians with college degrees and enlisted, non-commissioned officers may apply for OCS. Those accepted are assumed to have the requisite technical background already, and OCS provides only *military* training — leadership, tactics and so on. These characters will have the broadest leeway in design, since the applicability of the college degree is not considered — a journalism degree (and OCS) qualifies one to command an artillery company. The skills provided by the civilian degree can be any the GM will allow. OCS will ensure that the new officer is competent in all appropriate military skills (administration, strategy, tactics, various weapons and unarmed combat skills, etc.). Officers are also gentlemen, so they will be *trained* in Savoir-Faire (Military) and other social skills.

The Academy provides both technical knowledge and military training. Even three-year men who are not selected to become Lensmen are *very* competent military personnel. They have received not only all the military skills of an OCS graduate, but have also earned an well-respected engineering degree. They have studied astrogation, mathematics, atomic physics and many other academic courses in addition to the social and military skills required of an officer and a gentleman.

### **Gang Member**

As youths all over the galaxies gain their freedom and independence, they begin to rebel against "the system." Gangs and youth cults spring up and may interact with player characters. Whether the gangs provide atmospheric wallpaper or a real street corner menace, they will dress distinctively, act distinctively and distrust all outsiders. Some may dress tough but only be interested in music, others live for the next gang rumble. Gang members may be petty criminals, thugs or tools of organized crime. Members are fiercely loyal to their comrades and will follow them into danger. Competitiveness is strong, gang members may be rivals for leadership, for a girl or just for the hell of it.

*Advantages:* Alertness, Attractiveness, Strong Will and High Pain Threshold may prove useful. All combat-oriented advantages are appropriate. Danger Sense and Luck are helpful. Gang bosses or their powerful sponsors make appropriate Patrons.

*Disadvantages:* Gang members can suffer from the appropriately anti-social disadvantages of Addiction, Bloodlust, Greed, Illiteracy, Poverty, Code of Honor, Compulsive Behavior (causing trouble), Impulsiveness, Intolerance and Jealousy. Most gang members will have enemies, both other rival gangs and the police.

*Skills:* Typically gangs are adept at enjoying themselves and fighting hand-to-hand. Common skills are Area Knowledge, Brawling, Carousing, Dancing, Fast-Talk, Gambling, Knife, Leadership, Stealth, Streetwise, an appropriate vehicle skill and any weapon skills. Running might come in handy to elude rivals or cops.

### **Guerrilla or Partisan**

Any entity, wherever situate, could find himself in the position of resisting Boskonian from within. (It is even conceivable that a few irredeemable beings might resist *Civilization* after it had liberated them from Boskone!) Partisans are nothing but average citizens who lead a secret life of sabotage and terrorism against their oppressors.

*Advantages:* Any. Wish them Luck — they'll need it.

*Disadvantages:* Any. Secret and Enemies, automatically.

*Skills:* Any. Thief skills will be acquired, if not known before the conquest. Combat skills *should* not be necessary, in theory. Don't count on it.

### **Law Enforcement Officer**

Policemen exist throughout Civilization, ranging from sophisticated, highly capable urban forces to country constables with a jurisdiction that covers thousands of square miles in remote regions of distant worlds.

Police officers don't expect to come into contact with Boskonian's military might, but they wage a never-ending war on the zwilniks that poison Civilization's heart with their hellish drugs. Unfortunately, they are often the first to encounter heavily-armed opposition when they get too close to a zwilnik kingpin. They will then find themselves fighting a holding action, hoping that the Patrol shows up to reinforce them before they are overrun.

*Advantages:* Alertness, Combat Reflexes, Common Sense, Danger Sense, Intuition, Strong Will and Toughness are appropriate Advantages. Legal Enforcement Powers is almost mandatory, except for ex-cops and unlicensed private eyes. Police departments generally look out for their own, and cops stick together, so characters could easily have Allies to draw upon. A PI might have a Patron. Some cops get a Reputation, and some inherit one from their department.

*Disadvantages:* Virtually any will do, although Duty and Impulsiveness, perhaps coupled with Sense of Duty or even Code of Honor, are highly applicable. Many have Stubbornness, and some accumulate personal Enemies. In the Civilization of the Lens, there are more Honest cops than in any previous period of history.

*Skills:* Law is required. Brawling and combat skills are necessary. Social skills, Acting, Area Knowledge, Criminology, Interrogation and Streetwise are all useful for gathering evidence. Disguise will allow the officer to go undercover.

### **Lensman**

The wearers of the Lens of Arisia comprise the elite officers of the Galactic Patrol. They are the finest examples of their race — although many races cannot produce Lensmen. They are the *best*.

*Advantages:* The Lensman advantage (p. 28) includes Legal Enforcement Powers. Telepathy is required. Strong Will (or bought-off levels of Weak Will) is recommended. Lensmen have the most demanding, hazardous duties ever to burden a sentient being; their abilities must equal that challenge. Acute Senses, Combat Reflexes, Common Sense, Danger Sense, Double-Jointed, Eidetic Memory, High Pain Threshold, Immunity to Disease, Intuition, Luck (!!!), Rapid Healing, Toughness . . . a Lensman needs every advantage he can get.

*Disadvantages:* Code of Honor (Lensman's Load or Gray Seal), Enemy (Boskonian), Extremely Hazardous Duty, Honesty, and Sense of Duty (Civilization) are required. Many other disadvantages disqualify one from Lensmanship, but Fanaticism, Bloodlust, some Compulsive behaviors, Gullibility, Lecherousness, Overconfidence, Stubbornness, Dependents, Intolerance and some Odious Personal Habits and Quirks are appropriate.

*Skills:* A Lensman is supremely able. He must represent Civilization at all times. As well as all the broad base of technical knowledge and superb level of military training of a Galactic Patrol officer (p. 21), he is taught diplomacy, law, psychology and similar subjects. He will frequently operate alone, and so can maintain and repair all equipment on which he may have to rely. His combat skills are nonpareil. His telepathic skills are finely honed.

### **Professional Criminal**

Civilization, like all previous cultures, has its share of those unwilling to abide by the rule of law. *Cat burglars* specialize in getting into well-protected offices or dwellings. They sometimes assist in espionage operations, or sabotage. *Armed robbers* take money or other goods away from people by threatening them with violence. *Hijackers* are armed robbers who concentrate on vehicles. They are the most likely to work in teams. *Petty thieves* are found in nearly any bad neighborhood; they'll strip your ground-car, pick your pocket, snatch your purse or smash-and-grab anything in sight.

*Advantages:* Acute Senses, Alertness, Ambidexterity, Danger Sense, Double-Jointed, Luck, Night Vision.

*Disadvantages:* Enemy (such as the law), Greed, Kleptomania, Overconfidence, Paranoia, Poverty, Reputation and Low Status.

*Skills:* Acrobatics, Area Knowledge, Carousing, Climbing, Fast-Talk, Gambling, Jumping, Running, Throwing and, of course, any Thief skills.

### **Meteor-Miner**

For the most part, meteor-miners are the scum of space, scouring asteroid belts for those few rocks that contain platinum, osmium or other noble metals and those very few that contain diamonds or other gems. They are the sheer misfits of life. Many are petty criminals, fugitives from justice on various planets. Nearly all are unable to hold steady jobs, because of addictions or berserk tempers. All are master spacemen.

*Advantages:* Absolute Direction and Timing will help the seat-of-the-pants navigational techniques used, Alertness to combat the fatigue of the work, Intuition or Luck to pick the right rock.

*Disadvantages:* Greed is a prerequisite. Addictions, Alcoholism, Bad Temper or even Berserk, Compulsive Behaviors, Delusions, Kleptomania, Overconfidence and many other mental disadvantages could drive a man to the asteroid belts.

*Skills:* All spaceman skills (p. 31), Beam Weapon, Geology, Engineering (Mining), Professional Skill: Spee-Gee Operation (Mental/Easy).

### **Pirate**

The commanders of the Galactic Patrol originally believed that Boskonian was nothing more than a syndrome of widespread piracy. They learned that it was, in fact, an intergalactic tyranny that never renounced its ultimate goal of universal conquest.

However, sometimes a pirate is just a pirate. At many places throughout the galaxies, a ship-full of cargo — or an entire spaceship! — can be sold with no awkward questions being asked. Both Civilization and Boskonian support privateering, allowing pirates free rein as long as they restrict their predations to the other side's ships.

*Advantages:* Allies, Reputation and Wealth belong to successful pirates. With both the Galactic Patrol and cold space itself trying to kill you, Luck can be a bonus.

*Disadvantages:* After a few years of pirating, accidents and combat may leave their mark: One-Armed or -Handed, One-Eyed and slightly Lame pirates are common.



*Skills:* All the standard spaceman skills and good combat skills are required. Intimidation and Merchant can increase profits.

### **Radicals**

Any government, no matter how enlightened and benign, will be opposed by a radical fringe. Not all radicals are dupes of the opposition; in theory, anarchists want to see the removal of all forms of government. They may be supported, covertly or openly, by the opposing side of the war, but some of the members of the fringe are there for purely personal reasons.

Radicals range in approach from bomb-throwing loonies to calm and competent experts trying to alter the system from within. They can be found on street corners, loudly advocating violent civil insurrection, or on broadcast talk shows lobbying for changes in the government.

*Advantages:* The more urbane and sophisticated radical might have Charisma or Voice. Radicals frequently hang around together, so they may have Allies. (However, many radical groups by nature aren't going to be overly organized.)

*Disadvantages:* Particularly the more rabid will have Odius Personal Habits, Poverty, Reputation (bad) and Status (worse). Delusions, Fanaticism and Paranoia are always appropriate.

*Skills:* Economics, Politics and Public Speaking. For the more violent types, Demolition is good, as are all combat skills.

### **Scientist**

The scientist is a researcher or professor who is an expert in a body of knowledge. The subject can be virtually any of the Scientific skills except for those dealing with engineering and technology. Such skills are in the realm of the engineer (see above) who specializes in construction and development. A scientist will find employment with a university as a lecturer or a research student, with a government agency or an independent group — a "think-tank."

Scientists have less opportunity for heroic action than warriors, but their obsession with learning the Truth can give them their own kind of bravery: "Nonsense! I have subjected the affair, every phase of it, to a rigid statistical analysis. The probability is significantly greater than zero — oh, ever so much greater, almost point one nine, in fact — that the ship will return, with my notes."

*Advantages:* Reputation amongst other scientists can be valuable, as can Language Talent, but none are essential.

*Disadvantages:* As with engineers, physical disadvantages are common. Age, Bad Sight, Hard of Hearing or Lame are all acceptable. Some mental disadvantages that would disqualify him from military service are also appropriate (Absent-Mindedness is a cliché, but particularly obnoxious scientists will indulge in Bad Temper, Overconfidence and Stubbornness). Sense of Duty (to Discover and Teach the Truth) is possible for particularly noble examples.

*Skills:* Expertise in one Scientific skill and familiarity with one or two others is almost mandatory. Academic careers include but certainly aren't limited to: anthropologist, archaeologist, astronomer, biologist, chemist, geologist, linguist, physicist and psychologist.



## **Secret Agent**

The secret agent works either for any of Boskonian's or Civilization's intelligence agencies (or a neutral government, though these are rare) and either operates within his enemy's dominion under a secret identity or at home conducting counter-espionage. The trade in secrets and sensitive information remained in full flow in both directions throughout the Boskonian War.

The War also includes covert acts of sabotage, surveillance, kidnapping and blackmail. *GURPS Espionage* will be useful to a GM planning to include the "undetected war" in his campaign.

*Advantages:* There are plenty of useful advantages available for the secret agent: Acute Senses, Charisma, Combat Reflexes, Danger Sense, Eidetic Memory, Language Talent and Night Vision are but a few. Luck helps.

*Disadvantages:* Secret agents invariably have powerful Enemies and regular Duties. Their dangerous lifestyle can give rise to various mental disorders including Bully, Compulsive Behavior (such as elaborate daily security procedures), Overconfidence and Paranoia. Cowardice is easily hidden in this profession. Some agents have Fanaticism as a motive, while others are Greedy.

*Skills:* An agent may require "cover" skills to infiltrate an enemy organization, but other skills include Acting, Fast Talk, Area Knowledge, Gun (Pistol), Brawling, Demolitions, Escape, Forgery, Holdout, Lockpick, Sex Appeal, Carousing, Shadowing, Stealth and Disguise. Savoir-Faire and Language skills are needed to pass as a native of an area.

## **Spaceman**

There are hundreds of times as many civilian ships of space as there are vessels of the Galactic Patrol. They range from super-freighters larger than dreadnoughts to tiny in-system pleasure craft, but all of them require some crew. These civilian spacemen can be technical wizards capable of fixing almost anything or complete duffers. Most will have served at least one hitch in the Patrol.

*Advantages:* Absolute Direction, Alertness, Combat Reflexes, retired Military Rank or Strong Will.

*Disadvantages:* Bad Temper, Fanaticism, Intolerance (of ground-grippers), Lecherousness, Paranoia or Sense of Duty to other spacemen.

*Skills:* Generic spacemen have great scope in their skills. Astrogation, Free Fall, Guns, Inertialess Agility, Mechanic (Bergenholm), Survival, Electronics Operation and Vacc Suit are common.

## **Technician**

A scientist dreams it up and an engineer builds it, but it is the technician who keeps it running. He may not have a deep understanding of the theory behind the application nor the ability to design one from scratch, but there is no one who can open it up, crawl around in its guts, tune it to 113% optimum performance, or patch it up if it breaks like the trained technician.

*Advantages:* High DX is important. Acute Senses and Ambidexterity would be handy. Common Sense and Mathematical Ability are almost required.

*Disadvantages:* Physical disadvantages will hamper performance. Overconfidence is common. Impulsive technicians don't live long.

*Skills:* Electronics Operation, Engineer, Integrating Calculator Operation, Mechanic, Scrounge. Many techs have Craft skills as well.

## **Writer/Journalist**

A war correspondent will obviously be trying to get into the thick of the action, but nearly any other type of writer can also find himself involved in the struggle against Boskonian. A journalist of any sort will routinely research sensitive subjects, which may lead to discoveries jeopardizing his very life! Even a writer of pulp fiction may be mildly interested in the "real thing" and seek interviews with Patrolmen or zwilniks.

*Advantages:* Media reporters will find Voice and perhaps a good Appearance valuable, and all journalists will benefit from Alertness, Charisma, Common Sense, Empathy, Intuition, Language Talent, or Luck. A very few successful writers enjoy Reputation, Status and even Wealth.

*Disadvantages:* Poverty is a common disadvantage, others include Impulsiveness, Cowardice, Overconfidence, Shyness and Stubbornness. Journalists have also been known to acquire Enemies by uncovering shady deals or corruption. Alcoholism or other Addictions all too often appear to be an occupational hazard for writers.

*Skills:* Bard, Detect Lies, Fast-Talk, Photography, Psychology, Research, Streetwise, and Writing are basic career skills. Other helpful skills are Diplomacy, and a journalist will have a specialist subject for his "desk" (such as Law, Economics, Literature and Area Knowledge). Carousing can be a good addition.

## **Zwilnik (Drug Dealer)**

The drug trade is ubiquitous, deadly and very, very profitable. It employs thousands of millions of beings, from the chemists and biologists that develop and synthesize the hellish products to the actual smugglers, couriers and runners who physically move the product. As with any marketing system, the vast majority of the money goes to the top levels, but much of it stops at intermediate levels. It certainly pays better than any struggling or poor job.

*Advantages:* Acute Taste and Smell to detect bad stuff. Alertness, Combat Reflexes, Danger Sense, Intuition and Luck will help the career to continue. Common Sense is debatable — is risking the lethal chambers for a great profit *STUPID*? A Patron is almost required, and Reputation and Wealth will soon be gained.

*Disadvantages:* A zwilnik that samples his own wares will soon be a dead zwilnik, either from a fatal overdose or a fatal mistake caused by operating at less than full efficiency. Greed is almost a certainty; why else take the risk? Secret is required, and Enemies will soon show up.

*Skills:* The life of a zwilnik is one of constant danger, both from the Law and from rivals seeking to expand their territories. Social and Thief skills are appropriate. Most combat work will be done by hired thugs, but some familiarity with weapons won't hurt.

## ● ADVANTAGES, DISADVANTAGES AND SKILLS

Many of the existing *GURPS* advantages, disadvantages and skills can be interpreted in a new and interesting manner when applied to a campaign in the worlds of *Lensman*. In addition, several new abilities are appropriate for this background.



## ● ADVANTAGES

### **Allies**

*see p. B23*

Allies are NPCs who are loyal companions. A high-value Ally costs 15 points for one of 151-200 character points, plus another 5 points for every 50 character points the ally has.

Modify the Ally's cost for frequency of appearance as per p. B23.

### **Legal Enforcement Powers**

*see p. B21*

Lensmen are empowered to be judge, jury and executioner. Everywhere they go, their word is *law*. Their jurisdiction is universal, civil rights are meaningless to them, they may investigate in any manner they see fit, and they may kill with impunity. This advantage is subsumed in the Lensman advantage, and does not have to be bought separately.

### **Magical Aptitude**

*see p. B21*

Although some psionic effects may seem "magical," magic does not exist in the *Lensman* universe.

### **Military Rank**

*see p. B22*

There are ten possible military rank levels, ranging from 0 (private or able spaceman) to 8 (general or admiral), and an additional rank, unique to the Galactic Patrol: Unattached, worth 45 points.

### **Enlisted Men**

Enlisted men serve for a contracted number of years (an enlistment or "hitch"). They cannot resign from the Patrol; sometimes they are separated early for "compassionate reasons" (e.g., the death of a parent that leaves them sole support of an invalid). The enlistment is "for a term of not less than three years and as much longer as may be required by the needs of the Patrol. . . ." Ordinarily, a hitch is three years — patriotism is high enough in Civilization that the Patrol doesn't keep personnel that don't want to be there.

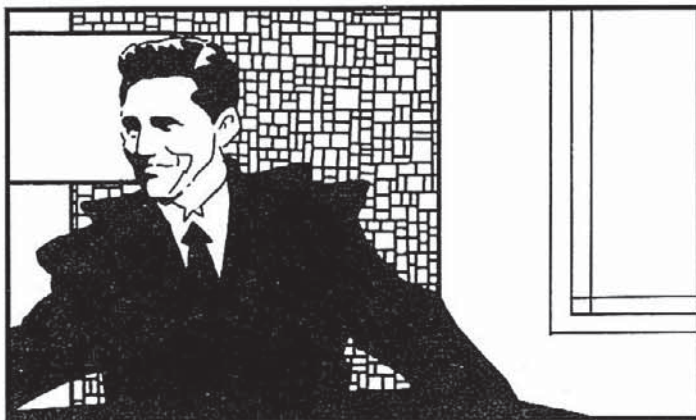

Military Rank 0 is the lowest rank. In the Marines, they are privates and privates, first class. In the Patrol they are apprentice and able spacemen.

Military Rank 1 is the junior NCOs: lance corporals, corporals, sergeants and staff sergeants in the Marines, third, second and first class petty officers in the Patrol. These enlisted men run the smallest units: squads, gun sections, individual vehicles. In space vessels, these are the division petty officers.

Military Rank 2 is the backbone of the Galactic Patrol — the senior NCOs. In the Marines, they are gunnery ("gunn'y") and master sergeants and sergeants major; in the Patrol, chief petty officers, senior chiefs and master chiefs.

### **Officers**

Officers are not enlisted for a fixed term of service; they are permitted to resign their commissions. All line officers should have the Enemy (Boskonian) disadvantage at some level.

Military Rank 3 is the lowest level for commissioned officers. They are third and second lieutenants, midshipmen and ensigns, and all warrant officers. Rank 4 consists of first lieutenants and captains, lieutenants junior grade and lieutenants. These junior officers serve on another officer's staff or command small groups. In the Patrol, they are the division commanders. In the Marines, they lead platoons and companies.

Military Ranks 5 and 6 are senior officers. Rank 5 is the majors and lieutenant colonels, lieutenant commanders and commanders. Rank 6 comprises colonels and captains. Line officers at this level are individually important enough that Boskone offers a standing reward for their assassination; they automatically have the Enemy (Boskonian) disadvantage at least at the -40 point level of "fairly often." In the Patrol, they captain ships of all sizes. In the Marines, they command battalions or brigades. Staff officers of these ranks lead major projects such as developing new weapons systems.

Military Ranks 7 and 8 are flag officers. Rank 7 is brigadier and major generals, commodores and rear admirals, while Rank 8 includes lieutenant generals and generals, vice admirals, admirals, port admirals and fleet admirals. Boskone will reward well the assassination of any line officer of this rank or higher; they automatically have the Enemy (Boskonian) disadvantage at least at the -80 point level of "quite often." Officers of these ranks command several divisions of Marines, a major task force of ships, or an entire theater of operations.

Only Lensmen are eligible for Military Rank 9 — the Release. A Released, or "Unattached" Lensman is answerable solely to his own conscience and may require any resource of the Galactic Patrol at any time. He can buy anything, anywhere in Civilization, by leaving a chit that the Patrol will redeem on demand. He is as free an agent as is possible for a living being

to be. This is the only rank that can be reached without passing through the lower ones — it is possible for a Lensman of Rank 3 to be Released. They are commonly known as Gray Lensmen, from the unadorned uniform of gray leather unique to this rank, and the set of all Gray Lensmen is referred to as the Gray Legion. Promotion to this rank immediately raises the disadvantage of Enemy (Boskonian) to the -120 point level of “almost all the time.” The servants of Eddore don’t like Gray Lensmen.

#### **Other Services**

Civilization is made up of millions of cultures, many with their own militaries. Rank in those other forces may not be as meaningful to a Patrolman as that of his own leaders. Accordingly, local ranks are less valuable. The cost of 5 points per level represents a fully respected rank in the Galactic Patrol (or Boskonian’s major forces).

For only 4 points per level, a character can have a less respected rank within those same forces. The situation becomes that of an ensign from Finance trying to lead a platoon of Mobile Infantry. They recognize the rank, but they don’t particularly respect the man until he proves himself. The character can have instead a fully respected rank in a subsidiary force, such as the Velantian Orbital Guard.

At 3 points per level, the rank is not particularly respected at all. It is an honorary rank carrying no extra pay or real permanent rank or is from a force that no one ever heard of (a Vandemar Volunteer Regiment, for instance).

If the rank is both from an obscure force and not well-respected even within that force, it costs only 2 points per level; a clerk-typist with that Vandemar Volunteer Regiment, for example.

A social, retired, honorary or titular rank is worth only one point per level. It *might* be good for a good social reaction. Militia captains, police chiefs, Kentucky “colonels” and old soldiers have this sort of rank.

#### **Patron: Gray Lensman**

*see pp. B24-25*

The Galactic Patrol, in general, does not count as a Patron for patrolmen. It is an omnipresent employer, providing hous-

ing, clothing, food and equipment as part of the soldier’s remuneration . . . but it does this equally for all its employees. (Likewise, Boskone is not the personal Enemy of all Patrolmen . . . just all Lensmen.) Patrons are more personal. The Patrol does have its share of cliques, good-old-boy networks and remember-when alliances. Knowing — and befriending or impressing — someone who may sit on your promotion board or who can obtain a choice assignment can be an important factor in a successful military career.

An average Lensman can be as useful a patron as any officer in any military organization, remembering that his freedom to act is directly proportional to his rank and position. His value can be easily determined from the guidelines on pp. B24-25.

A Gray Lensman, however, has no restrictions on his actions save his own conscience. If he should decide to aid another character, his capabilities are nearly unlimited. He is an extremely powerful individual, with access to equipment worth far more than an individual’s wealth, in many cases of a technological level well beyond the usual. His patronage is an Advantage worth a base of 30 points, adjusted for his frequency of Appearance. An Unattached Lensman will not aid a character unless it will advance the causes of Civilization, and he will certainly require a significant duty from his proteges.

A Gray Lensman Patron is a useful advantage to the GM, as well. His rank and duties makes it natural for him to suddenly appear, require the player-characters’ service on a highly dangerous mission — and then disappear again, battling the foes of Civilization in another galaxy.

#### **Patron: Mentor**

*see pp. B24-25*

Second-Stage Stability (p. 29) is a prerequisite for Mentor’s personal patronage, which in turn causes the Lensman to become the personal Enemy of all Boskonian (also p. 29). Mentor represents an entire race, provides extremely valuable equipment of very high capabilities and has unusual reach in time and space. He can be *reached* at any time, but he is almost certain to tell a Lensman that his thinking is inexcusably muddy and to work it out for himself. He will actually *do* something only rarely. His patronage is therefore worth 20 points.



## Alternate Identity

15 points

You have an extra identity, which to all appearances is legally established. Your fingerprints and other data are registered under two different names, you have two sets of licenses, passports, birth certificates and so on. This can be extremely useful for anyone who is involved in surreptitious or illegal activities, such as an undercover Lensman. You can purchase this advantage as many times as desired; each will give you a new identity. While the new identity may include lines of credit and bank accounts, all money in these accounts must be supplied by the character — it doesn't come with the package.

If a government agency has access to both identities and attempts to identify your prints, with no clues as to your name, there is an even chance which of your identities will come up. The search will stop at that point unless they have reason to believe you have a second identity. If the search continues, the second identity will of course come up, and you will be unmasked. At that point, once the agency decides who you "really" are, the other identity(s) are lost. A non-governmental agency will have more limited resources, and will probably not be able to eliminate alternate identities even if they find them.

Alternate Identities are either official or illegal. If you are caught using an unauthorized identity, you face stiff fines and a jail sentence. The Galactic Patrol maintains several Alternate Identities for its agents; Chester Q. Fordyce, the cosmopolite and dilettante, Bradlow Thyron, the arch-criminal with many years on the "Most Wanted" list and Sybly Whyte, the pulp writer, are three such. It can also create excellent cover stories as necessary, but those impromptu identities cannot be as thoroughly impeccable as one constructed long in advance.

## Temporary Identity

0 points

You have obtained a set of identity papers, and had the appropriate government records altered, to set up an Alternate Identity. However, the quality of the work is such that the new identity will eventually be noticed and eliminated (and the user sought after!). Therefore a Temporary Identity is not an "advantage," and costs no points. It is a convenience to be bought with cash.

A temporary Identity is guaranteed to be good for one week. At the end of that week, a roll is made. On an 8 or less, the false records have been discovered. Each week an additional roll is made at a cumulative +1 (e.g., the discrepancies are discovered at the end of week 2 on a 9 or less, and at the end of week 3 on a 10 or less.)

Cost of a temporary identity is negotiable, but averages \$500.

## Compartmentalized Mind

50 points each

*Second-Stage Stability (p. 29) is a prerequisite for this advantage.*

Your mental coordination gives you, in effect, more than one mind. Each mind, or compartment, functions independently at full capability. By default, each compartment is identical, but they are affected separately; e.g., one could be hypnotized without affecting any of the others.

This advantage does not allow a character's body to perform more than one task at a time; that requires Full Coordination. Thus, a character with five levels of Compartmentalized Mind and two of Full Coordination could perform six telepathic feats, but physically do only three.

Only one compartment controls the body at a time. If the compartments disagree on who should be in charge, roll a Contest of Wills, with the compartment currently in control of the body getting +1.

Compartments are considered completely separate mentalities for telepathic purposes. Each compartment must actively Telereceive or Telesend to another . . . and the other compartment may choose to resist the contact! If two compartments are in contact, another entity (a third compartment or an outsider) may be able to eavesdrop; see p. 101.

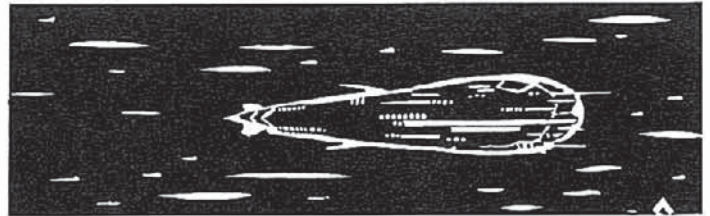

## Contacts

Variable

A Contact is an NPC, like an Ally or a Patron. However, the Contact only provides *information*. Contacts may be anything from a wino in the right gutter to the Galactic Coordinator, depending on the character's background. The Contact has access to information, and he is already known to and guaranteed to react favorably to the character. The Contact may want a price, in cash or favors, for the information. The Contact is always played and controlled by the GM and the nature of the price must be set by the GM.

The GM may assume that a Contact is, in general, well-disposed toward the PC. However, the Contact is *not* an Ally or Patron, and is no more likely to give special help than any other generally friendly NPC.

A Contact doesn't have to be created when the PC is first developed. Contacts may be added later. When appropriate, the GM can turn an existing NPC into a Contact for one or more players, possibly in lieu of character points for the adventure in which the Contact was developed and encountered.

Whatever the case, the Contact can provide information only about his area of expertise. The technician at the forensics lab probably has no information about currency transfers, and the manager of the local bank branch probably can't do a ballistics comparison. The GM assigns a skill (Streetwise for a minor criminal, Forensics for a lab tech, etc.) to the Contact. All attempts to get information from him require a secret roll by the GM against the Contact's "effective" skill. Note that the effective skill is not necessarily the NPC's *actual* skill; the actual skill can be set by the GM if the NPC comes into regular play. For instance, the president of a local steel mill might actually have business related skills of 16-18, but he has an *effective* skill of 21, making him worth 20 points, because he has good connections.

Point values for Contacts are based on the type of information and its effective skill, modified by the frequency with which they can provide information and the reliability of the information. Importance of information is relative and the list of possible Contacts is virtually endless; a few are listed below as a guide to help the GM determine value.

### **Type of Information**

**Street Contacts.** These are minor criminals, derelicts, street thugs, gang members, small-time fences and other streetwise NPCs who provide information on illicit activities, local criminal gossip, upcoming crimes and so forth. Base cost is 5 points for “unconnected” Contacts (not part of the local criminal organization; Streetwise 12) and 10 points for “connected” Contacts (Streetwise 15). If the contact is a major figure in a criminal organization (the Don, Clan Chief, or member of the “inner circle” of the family; Streetwise 21), the cost doubles to 20 points.

**Business Contacts.** Executives, owners, secretaries — even the mail room flunky — can provide information on businesses and business dealings. Base cost depends on how much the contact can be expected to know: 5 points for a mail boy or typist (effective skill 12), 10 points for the president’s secretary (effective skill 15), 15 points for an accountant (effective skill 18) or 20 points for the president or Chairman of the Board (effective skill 21).

**Police Contacts.** This includes anyone connected with law enforcement and criminal investigations: beat cops, corporate security, government agents, forensics specialists, coroners, etc. Cost depends on access to information or services. Beat cops and regular private security officers are 5 points (effective skill 12); detectives, federal agents or record clerks are 10 points (effective skill 15); administrators (lieutenants, captains, Special Agents in Charge, Head of Departmental Security, etc.) are 15 points (effective skill 18); and senior officers (sheriffs, chiefs of police, District Superintendents, Security Chiefs, etc.) are 20 points (effective skill 21).

**Military Contacts.** Anyone from enlisted men up to Chiefs of Staff. Military contacts can provide information on troop movements and assignments, missions and goals, details on secret weaponry and contractors, or intergalactic strategy. Cost depends on the rank (and thus amount of access) of the character: 5 points for a buck private or new recruit (Rank 1; effective skill 12), 10 points for an NCO or junior officer (Ranks 2-4; effective skill 15), 15 points for senior officers (Ranks 5-6; effective skill 18) or 20 points for a flag officer (Ranks 7+; effective skill 21). Add 5 points if the Contact is a Lensman — but remember, he can read your mind . . .

### **Intuitive Mathematician** **25 points**

This is a more extreme version of Lightning Calculator (see p. B21). Your ability is not limited to simple arithmetic; you can plot courses, inert, free or hyper-spatial, do any level of engineering design, solve differential equations almost instantaneously. You never need an integrating calculator; you yourself are far faster than such a gadget, and even faster than many automatic computers.

The abilities of Lightning Calculator (p. B21) and Mathematical Ability (p. B22) are included in this advantage.

### **Lensman** **100 points**

The Guardians of Civilization have entrusted you with an instrumentality, endowed with a sort of pseudo-life and serving as an unforgeable identification, a universal translator and decrypter, and granting you — or, rather, awakening in you — fantastic powers of the mind. See Chapter 6, *Telepathy and the Lens*. You are charged with the defense of the entirety of Civilization against all foes, wherever you find them.

This Advantage has many prerequisites and consequences. You must be an officer (Rank 4+) of the Galactic Patrol. You cannot be a human woman, a female Rigellian or a first-sex Palainian. (The GM will designate which, if any, sexes of other races cannot be Lensmen. See Chapter 1, *History and Society* for a full discussion of this requirement.) You must not have any of the disadvantages Bully, Compulsive Carousing or Gambling, Severe Delusions, Kleptomania, Megalomania, Paranoia, Pyromania, or Sadism. Mentor will learn any Secrets, and judge the character’s suitability. All parts of a Split Personality must separately meet all requirements. Mentor will not give a Lens to any being that does not already have the disadvantages of Code of Honor (Lensman’s Load), Honesty and Sense of Duty (Civilization).

The additional disadvantage Enemy (Boskonian) is also automatically acquired at the “quite often” level or more. The Lensman advantage includes Legal Enforcement Powers (see above) — that advantage does not have to be purchased separately.

You must also have the advantage of Telepathy. The Lens does not *grant* any abilities. It only amplifies them.

### **Sense of Perception** **100 points**

You have a sense that gives you “a practically perfect three-dimensional view of the entire circumambient sphere,” including inside objects. You perceive shapes, and colors if you have color vision. (Blind races such as Rigellians do not perceive colors.) Make an IQ roll, minus the range in hundreds of miles (so 1,000 miles is -10), to make out details.

### **Unfazeable** **15 points**

Nothing surprises you — at least, nothing that’s not obviously a threat. The galaxies are full of strange things, and as long as they don’t bother you, you don’t bother them. You are exempt from Fright Checks, and almost no reaction modifiers affect you, either way. You treat all strangers with the same distant courtesy, no matter *how* strange they are, as long as they’re well behaved. You will have the normal reaction penalty toward anyone who does something rude or rowdy, but you will remain civil even if you are forced to violence.

This advantage is incompatible with all phobias. A character with this advantage is not emotionless — he just never displays strong feelings. The stereotypical Maine Yankee or English butler has this advantage. *E.g.*, two fellows in rocking chairs on the porch of a general store:

*Ed:* “*What’d that little feller with them orange tentacles on his head want?*”

*Burt:* “*Just another lost summer tourist. Took a wrong turn at Mars.*” (*Looks up in the sky.*) “*Looks like it’s gonna rain tomorrow.*”

*Ed:* “*Ayuh. Looks like.*”

This advantage must be roleplayed fully, or the GM can declare that it has been lost. In a campaign where Fright Checks are an hourly occurrence, the GM can charge 20 or more points, or disallow the advantage.

### **Unusual Background — Exalted**

### **Special**

Being an exalted member of a race is not bought as a single advantage, but is a set of advantages and disadvantages (and possibly bought-off racial disadvantages) that must be paid for separately. If these criteria are met when a character is created, he can be marked "Exalted" and any other advantages that have it as a prerequisite can be added. No one can become Exalted during play — either you are well-bred or you aren't.

You are one of the many off-shoots of the prodigiously long blood-lines carefully manipulated by the Molders of Civilization. You are one of the finest possible examples of your race. In many races, one example being humanity, being a member of the exalted sub-species is a prerequisite for Second-Stage Stability.

You are an excellent physical specimen, with ST, DX and HT at least one point better and IQ at least two points better than your race's norm. You have Longevity and Rapid Healing.

Bred for mental power and scope, you have Alertness of at least +1, at least one level of Eidetic Memory, Intuition, at least one level of Luck, Telepathy at power 3 or better and at least two levels of Strong Will (or fewer levels of Weak Will) than usual for your race. Any defects of personality are at least one

level better; e.g., Exalted Rigellians are not Obdurate and Hidebound, but are no worse than Incurious (roll versus IQ to avoid ignoring something strange; -1 reaction to new things; -5 points) and Dull, while Exalted Palainians have no Cowardice.

You are intended to lead your people and have an Attractive or better (to your own people, anyway) Appearance and Charisma of at least +1.

You were designed to be attracted to causes, with Fanaticism, a -5-point Code of Honor and a -10-point Sense of Duty (both designated by the player). You are probably (but not necessarily) Overconfident, a result of growing up among mere normals.

### **Unusual Background — Second-Stage Stability**

**25 points**

*This advantage is restricted to Exalted characters only or as part of a racial package.*

You are intrinsically stable at the second level of stress. You take Fright Checks at +20. You are capable of disciplining your mind sufficiently to learn telepathic skills beyond the basic Telescan, Telesend, Telereceive and Mind Shield that are all lesser minds are capable of comprehending. If you receive a Lens from Mentor of Arisia, you will *not* be told "... and stay out!" as other Lensmen are. Once you attain the other requirements for Second-Stage, you may return to Arisia for further training. (What those requirements are varies from race to race, and are known only to Mentor — and the GM.)

## ● DISADVANTAGES

### **Addiction**

*see p. B30*

Despite (Boskonian propaganda would say "because of") rigorous enforcement of controlled substance laws, drug abuse has continued to spread in all levels of all societies.

Many drugs are extremely addictive, many have grievous side-effects and nearly all carry very heavy legal penalties. Accordingly, this disadvantage can be an extreme one; in the case of thionite (p. 86) it is worth -75 points!

### **Color Blindness**

*see p. B28*

GMs should remember that this frequently chosen disadvantage will seriously hamper the character's engineering abilities. Even at the -5-point level, a color-blind person cannot read resistor codes or tell the green wire from the blue wire, and finds it much more difficult to tell Sirius from Antares than the fully-sighted navigator.

### **Enemy (Boskonian)**

*see pp. B39-40*

Boskone is an utterly formidable group, worth a base of -40 points. Non-Lensed members of the Galactic Patrol will encounter Boskonian fairly often, so that value is unmodified. Lensmen will encounter Boskonian quite often, for a doubled value of -80 points. Unattached Lensmen will be face-to-face with the full armed might of Boskonian almost all the time, for a tripled value of -120 points.



### **Social Stigma**

*see p. B27*

In the Galactic Patrol and in many parts of Civilization, human women have the -5-point Social Stigma of second-class citizen. They are restricted from any job that involves any physical danger, and they are paid 75%-90% of what a man would make in the same job.

See Chapter 1, *History and Society*, for more on the role of women in Civilization.

## NEW DISADVANTAGES

### **Appearance: Horrific**

**-30 points**

Your hideous, nightmarish appearance causes strong men's senses to reel. You suffer a -10 on any reaction roll. On first meeting, you cause strangers to take an immediate Fright Check.

It is extremely unusual for normal beings to have appearances this terrifying. In general, it is reserved for unnatural monsters, or for alien races that happen to match another's leg-ends.

### **Code of Honor**

**Variable**

The codes given are for humans. Exact terms vary slightly from race to race, but their total value remains the same.

### **Galactic Patrolman**

**-5 points**

Be prepared to give your life in the defense of Civilization against any enemy wherever situated. Never surrender. Give no quarter, aid nor comfort to the enemy. Yield no information nor take part in any action that might be harmful to Civilization. Respect and obey your superiors. Require discipline and obedience from those under your command. Know your duties. Instruct your subordinates in theirs.

### **Lensman's Load**

**-10 points**

A Lensman is a supremely able entity, before whom nearly any other being is utterly helpless. The only thing that restrains a Lensman and protects the rest of Civilization from him is his Code of Honor, which includes all the provisions of a Galactic Patrolman's, plus: be responsible, in the fullest sense, for all of your actions. Represent Civilization and all that means to the rest of the universe. Keep your ethics and sense of justice above reproach. Be the embodiment of the highest possible integrity and reliability. Never break your word. While you live, never quit. Regardless of the odds, if there is any chance at all, always go in. Pay your debts, even to spiders and to worms.

### **Gray Seal**

**-15 points**

All the provisions of the Lensman's Load, plus: assume *personal* responsibility for the protection and defense of Civilization in its entirety. The GM can act as the Lensman's conscience, at any time informing a player whose character is under Gray Seal that his actions are not in accordance with the best interests of Civilization (as he believes them to be), and the player must immediately correct those actions.

### **Extremely Hazardous Duty**

**-20 points**

This is an increased level of the Duty disadvantage described on p. B39. The character is "on duty" almost all the time, and risks death or serious injury more often than on ordinary duty. There are significant penalties for failure to perform the duty when demanded: dismissal in disgrace, imprisonment, perhaps even death — or the downfall of Civilization itself. This is a mandatory duty of all Lensmen of the Galactic Patrol.

### **Free Sick**

**-10 points**

You are miserable under "free" (inertialess) conditions. This disadvantage is handled identically to Space Sickness, substituting inertialess for weightless; see p. S34.

### **Innumerate**

**-1, -5 or -10 points**

You have no "feel" for numbers. You cannot do *any* arithmetic in your head, and you have no idea whether the answer you get on paper or on a calculating machine is correct. You must painstakingly count your change from a merchant.

In a non-technological environment this is only a -1 point Quirk. Most technological cultures cater to their impaired members enough to make this only a -5-point disadvantage, but in a society that values engineering ability highly (such as the Civilization of the Lens), it is worth -10 points.

### **Involuntary Duty**

**-5 points more**

If a Duty is enforced by threats to self or loved ones or by mind control, it is involuntary. Such a forced duty can result in difficult decisions or surprising insights for the affected character. An involuntary duty would *not* include any "normal" societal duty such as military service by draft, although service by impressment, as practiced by many Boskonian societies, would qualify. Only cases where life or sanity are directly at stake qualify.

For instance, if a Patrolman's family were taken hostage and he were told to spy or they would become a light snack for an Overlord, he would have an involuntary duty bonus.

### **Manic-Depressive**

**-20 points**

Your moods are on a see-saw — you bounce back and forth between bubbling enthusiasm and morose withdrawal. At the beginning of each play session, roll one die. On a 1-3, you are in your manic phase; a 4-6 indicates depression. Every five hours of game-time thereafter, roll 3d. A 10 or less indicates that you begin a mood swing. Over the next hour, you will shift from your current phase into its opposite. You will remain in the new phase for at least five hours (after which you roll 3d again).



In the manic phase, you suffer from Overconfidence (see p. B34). You will be friendly, outgoing and excited about whatever you're doing. In the depressive phase, the Overconfidence is replaced with Absentmindedness (p. B30) and Laziness (p. B34). You will not be interested in doing anything except lying in bed, sitting in a dark room and moping, or similar activities. If forced by companions to do something, you will be at a -5 on all skills.

### **Secret**

A Secret is some aspect of your life (or your past) that you must keep hidden. If made public, the information could harm your reputation, ruin your career, wreck your friendships, and possibly even threaten your life.

The point value of a Secret depends on the consequences if the Secret is revealed. The worse the results, the higher the value, as follows:

*Serious Embarrassment.* If this information gets around, you can forget about ever getting a promotion, getting elected, or marrying well. Alternatively, your Secret could be one that will simply attract unwelcome public attention if it is known. *-5 points.*

*Utter Rejection.* If your Secret is discovered, your whole life will be changed. Perhaps you could lose your job and be rejected by friends and loved ones. Perhaps you will merely be harassed by admirers, cultists, long-lost relatives, or the press. *-10 points.*

*Imprisonment or Exile.* If the authorities uncover your Secret, you'll have to flee, or be imprisoned for a long time (GM's discretion). *-20 points.*

*Possible Death.* Your Secret is so terrible that you might be executed by the authorities, lynched by a mob, or assassinated by Boskonian agents if it were ever revealed — you would be a hunted man. *-30 points.*

If a Secret is made public, there will be an immediate negative effect, as described above, ranging from embarrassment to

### **Variable**

possible death. There is also a lasting effect — you suddenly acquire new, permanent disadvantages whose point value equals *twice* that of the Secret itself. The points from these new disadvantages go first to buy off the Secret, and may then, at the GM's option only, be used to buy off other disadvantages or (rarely) to buy new advantages. Any unused points are lost, and the character's point value is reduced.

The new disadvantages acquired must be appropriate to the Secret and should be determined (with the GM's supervision) when the character is created. Most Secrets turn into Enemies, Bad Reputations, and Social Stigmas. They might also reduce your Status or Wealth, or might cause you to lose an Ally or a Patron — going from Filthy Rich to merely Very Wealthy is effectively a -10 point disadvantage. Some secrets could even turn into mental or physical disadvantages, though this would be rare.

Similarly, if the GM allows you to buy off old disadvantages with the new points, these too must be appropriate to the Secret. The most common disadvantages that could be bought off are Duties and Dependents.

In general, a Secret appears in a particular game session if the GM rolls a 6 or less on three dice before the adventure begins. However, as for all other disadvantages of this type, the GM need not feel constrained by the occurrence roll — if he thinks the Secret should come into play, it does.

When a Secret appears, it is not necessarily made public. The character must somehow prevent the Secret from being revealed. This may require him to cave in to blackmail or extortion, to steal the incriminating documents, or even to silence the person who knows the Secret. Regardless of the solution, however, it's only temporary — the Secret will appear again and again until it is finally bought off. Secrets may be bought off either automatically through exposure (see above) or with earned character points over the course of play.

## ● SKILLS

### **Armoury**

*see p. B53*

This skill is subdivided into many specializations, one for each type of ships' weapons systems (such as Needler or Primary Beams) and for Tractors, Pressors, Screens and so on. It also includes the various models of battle armor, and psychotronic equipment such as thought screens.

### **Computer Operation and Programming** *see pp. B58, B60*

A computer is a *person* with mathematics skill who operates an integrating calculator. These skills are replaced by Integrating Calculator Operation (p. 32) and Mechanic (Integrating Calculator). After the end of the Boskonian War, *automatic* calculators and computers begin to be developed — see p. 65.

### **Electronics and Electronics Operation** *see pp. B58, B60*

The skills a technician of Civilization or Boskonian uses to operate and maintain his electronic equipment are unlike those of *any* other period or genre. The extremely sophisticated ultraminiature vacuum tubes used are absolutely unique to a *Lensman* campaign. *Psychotronics* is the specialty of equipment with effects on the mind, such as thought screens.

### **Hypnotism**

*see p. B56*

Successful use of Suggestion or Telesend gives a +2 bonus to Hypnotism rolls (p. B56).

A subject in a hypnotic trance has less resistance to telepathy. For every 2 points the Hypnotism contest of skill succeeded by, reduce both the subject's effective Will and the Power of any natural Mind Shield (not artificial thought screen) by 1.

### **Mechanic (Integrating Calculator)** *see p. B54*

This is the skill required to reconfigure an electromechanical integrating calculator to solve new functions. To *design* the change, roll against the lower of Engineer (Electrical), for the requisite relays and motors, and Engineer (Mechanical) for the cams and pushrods. A mechanic is also necessary to properly clean, tune up and repair calculators.

### **Language Skills** *see p. B54*

Each language is a separate skill. Alien languages do not default to one another unless they somehow derive from the same parent tongue (*e.g.*, Valerian and Tellurian Dutch default to one another at -2).





*Easy:* Spaceal is an artificial language designed to allow a wide variety of beings to communicate highly technical ideas. It has also acquired a limited vocabulary to handle other aspects of life, which is uniformly profane, obscene, vulgar, lewd, coarse and foul. (For example, it has only four words to represent any law enforcement official. In English, stripped of obscenity and in descending order of contempt, they would be "lawman," "cop," "flatfoot" and "bull.") It is one of the most expressive languages ever spoken in terms of invective, swearing, insults, contempt, epithets and scorn.

*Average:* Galactic Spanish is very common, since many alien races find its softer consonants easier to enunciate than English's.

*Hard:* Alien languages that can be pronounced using a character's natural vocal equipment or simple mechanical devices.

*Very Hard:* Alien languages that cannot be pronounced with a character's natural vocal equipment or simple mechanical devices.

### ***Piloting (Inertialess)*** ***(Physical/Hard)***

***No default***  
***see p. B69***

A pilot has a complex job. He is in direct, manual control of the mighty reaction engines that roll, spin, twist and drive the huge masses of metal that are the ships of space. Each single jet is activated by one of the keys that surround the pilot's station in bank upon bank like a great organ. They are "velocity-sensitive"; a light tap causes a small impulse; a firmer pressure on the same key produces a strong blast. They can also be pressed into several detents to create a constant level of any given thrust. A master pilot's hands must sweep over his board "as rapidly and as surely as those of an organist over the banked keys of his console; producing, not chords and arpeggios of harmony, but roaring blasts of precisely-controlled power."

Nor does a pilot's job become much easier during simple straight-line flight. The interstellar medium — the "ether" for lack of a simpler term — is a chaotically turbulent, highly charged and heated plasma that constantly buffets a racing spaceship and requires a smooth hand at the helm to maintain a course. See *Gazetteer*, p. 52, for further description of the ether.

## ● NEW SKILLS

### ***Emmfozing (Physical/Hard)***

***Defaults to DX-6;***

***Prerequisites: see below***

Emmfozing, a part of the Palainian reproductive process, is incomprehensible by members of races with only two sexes and three physical dimensions. Let it suffice to say that it can be learned and used by Palainians in ways vaguely analogous to the human Professional Skill: Erotic Arts.

### ***Dexitrobing (Physical/Hard)***

***No default;***

***Prerequisites: see below***

This skill cannot be learned or even fully comprehended by any creature without a metabolic hyper-extension. It is based on HT, not DX. Success on a skill roll once a minute serves as the advantage of Vacuum Support, allowing survival in vacuum with no damage from internal pressure or temperature and no need to breathe. Failure causes loss of one fatigue point and gives a -1 on the next Dexitrobing roll; critical failure, 1d fatigue points and a -2 penalty. If fatigue reaches zero, the character passes out and dies four minutes later. Fatigue cannot be regained while dexitrobing. Critical success is the only exception: it restores one fatigue point if any have been lost.

### ***Inertialess Agility (Physical/Hard)***

***No default***

This is the ability to handle yourself under "free" (inertialess) conditions. It is handled identically to the skill of Free Fall; see p. B48.

### ***Integrating Calculator Operation*** ***(Mental/Average)***

***No default***

The electromechanical calculators used for numerical analyses can be of great assistance in solving complicated arithmetic problems, including exponential and trigonometric functions, but they are not simple to use. This skill of use does not include setting the calculator up to solve new functions — for that, you need to design new cams with the skills Engineer (Electrical) and (Mechanical), then machine and install them with Mechanic (Integrating Calculator).

### ***Intimidation (Mental/Average)***

***Defaults to ST-5***  
***or Acting-3***

Intimidation is a social "influence" skill, used for persuasion. The essence of intimidation is to convince the subject that you are able and willing, and perhaps eager, to hurt him.

Intimidation may be substituted for a reaction roll in any situation, though it is at a -3 penalty when used in a request for aid. A successful Intimidation roll gives a Good (though not friendly)

reaction. A failed roll gives a Bad reaction. Most people will remember an intimidation attempt, whether successful or not, for a long time; it can permanently affect an NPC's attitude.

When Intimidation is used against a PC (or, at the GM's option, against a NPC), this can also be rolled as a contest of Intimidation versus Will. See *Influence Rolls*, sidebar, p. B93.

**Modifiers:** Up to +2 for displays of strength or bloodthirstiness, or +3 for superhuman strength or inhuman bloodthirstiness. Appropriate reputation modifiers will certainly count. +1 for each 6" of height that you have over the subject (+5 maximum), -1 if you are shorter (-2 if you are more than 6" shorter). +2 for Horrific Appearance.

The GM may give a further +1 bonus for witty or frightening dialogue, but should apply a penalty if the attempt is clumsy or inappropriate. Fearlessness counts *against* intimidation attempts. The GM may apply any level of penalty if the PCs are attempting to intimidate somebody who, in his opinion, just can't be intimidated. This includes anyone with the Unfazeable advantage.

**Psionic Modifiers:** Telepathy can be used to frighten people. If any such ability is used to supplement an attempt to intimidate, allow +2 for a successful attempt — +4 for a critical success. A failure has no effect unless the GM wants to penalize a critical failure in some creative way.

**Intimidating a Group:** This skill may be used against several people at once. For every five targets you attempt to intimidate with a single roll, apply a -1 penalty to your skill — up to a maximum of -5 (25 people). A single person cannot intimidate a group of larger than 25 people. A group of characters may attempt to intimidate a group of larger than 25 — 3 characters could intimidate up to 75 (3x25) people. Use the bonuses of the *best* intimidator in the group, and the penalties of the toughest target in the enemy group.

**Running a Bluff:** If the PC can make both a Fast-Talk and an Intimidation roll, and roleplays it well, he can appear to be intimidating even when he can't back it up. This is the only way to intimidate some people (martial arts masters, world leaders, belliscose drunks). Success on both rolls gives a Very Good reaction. Success on one and failure on the other gives a Poor reaction. Failure on both gives a Very Bad reaction.

Note that Interrogation can default to Intimidation-3. It will not help you tell a good answer from a bad one, but it can get people to talk.

### **Mind Block (Mental/Average) Defaults to Will-4**

This is the ability to set up a non-telepathic mental block to prevent telepaths from listening in on thoughts with Telereceive.

Examples of mental blocks might be doing complicated mathematical calculations or repeating poetry over and over again. Anyone can do this for a short time (roll versus Will+4 for the first minute), but maintaining a deliberate mental block

while doing something else, under stress, or for more than a minute, requires skill. A new roll may be required each minute that the person does nothing, or each turn in combat or stressful situations (*e.g.*, when someone is *trying* hard not to think about something of concern).

Roll a Contest of Skills between Mind Block and Telereceive, once each minute or more frequently. This is separate from any other roll required to make the skill work or to get through a Mind Shield. If the subject wins, the telepath will get nothing but poetry or the multiplication tables. If he loses, he is not successfully blocking. A successful Telereceive will discover part or all of whatever he is thinking. If the Mind Blocker rolls a critical failure, *he thought about it* — in detail — in the forefront of his mind.

After the first minute, if someone is doing nothing but concentrating on blocking, they get a +2. Someone who is mentally or physically stunned rolls at -3. Rolls to hide emotional thoughts rather than simple information are harder, and should made at -2 or more depending on how strong the GM rules they are. GMs may impose additional penalties or bonuses for other circumstances, *e.g.*, trying to hide your intentions while sneaking up on your most hated enemy, or using extensive acting experience.



### **Muscle Reading (Mental/VH) No Default; Prerequisites: Physiology, Psychology and Trained by a Master**

Muscle Reading is the skill of learning a being's intentions by feeling involuntary muscular tensions. The player must ask the GM a single yes/no question, while the character hints about the desired information to the subject of the Reading. A successful skill roll answers the question. Critical success yields extra information, while failure provides no information, and critical failure produces *misinformation*. A roll of a natural 18 causes the subject to notice that the reader is groping him in an odd place.

A separate version of this skill must be learned for each species. Knowledge of the appropriate species' physiology is required to locate the appropriate muscle groups, and of psychology to successfully make the leading comments that will cause the subject to subconsciously react. Training in this art is extremely difficult to obtain, requiring the Trained by a Master advantage (p. MA25, essentially a 40-point Unusual Background).

This skill differs from the *GURPS Martial Arts* skill of Body Language in what is read (tension versus posture), what is learned (the subject's attitudes rather than his next physical move), and the method of sensing the signals (a blind person can be an excellent Muscle Reader). It is not related to Detect Lies at all, which is a psychological technique; nor is it Empathy — it can be learned.

It is a tactile skill. Touching the subject's torso is required (for humanoids — requirements for other races are GM's option). Bonuses for sensitive touch apply. Each question takes one second. There is no bonus or penalty for repeated attempts.

**Modifiers to Skill**

**Subject's clothing (or hide):**

Bare skin .....	+2
Shirtsleeves .....	0
Suit jacket .....	-1
Sweater.....	-2
DR 1.....	-3
DR 2.....	-10
DR 3+.....	impossible

**Reader's Proximity:**

Hearty handshake (hand on shoulder).....	0
Chaste dancing .....	+1
Chaste hug .....	+2
Lascivious hug or dancing*.....	+4
Full body contact*.....	+6

\* Under most circumstances, these proximities will be interpreted as a seduction attempt.

**Subject's Intoxication:**

Cheerful/Mellow .....	+1
Elated.....	0
Boisterous .....	-1
Unsteady .....	-2
Drowsy.....	-4
Weaving.....	-8
Vomiting or worse .....	impossible

Muscle Reading does not *have* to be subtle. It is possible to use it for direct, overt interrogation — stripping a prisoner, grabbing him in the most effective way possible and asking direct questions. This would result in a +8 to the skill rolls, and possibly affect the interrogator's Reputation in interesting ways.

Attempted use of Muscle Reading may be detected. A Muscle Reader who suspects an attempt to read him may roll against his own skill (modified by proximity as above, but by his *own* clothing). Success reveals whether or not an attempt is being made. Failure reveals nothing ("you can't tell"), and critical failure gives the wrong answer. Note that just as an enthusiastic Reading can be mistaken for a seduction attempt, seduction may make a suspicious person worry about being read. A skilled Reader can also spot a Reading attempt on someone else, by sight — roll as above, but with an additional -5. Muscle Reading may be *resisted* only by the Martial Arts skill of Body Control, as a direct Contest of Skills. Note that it is irrelevant whether or how the victim answers the leading comments or questions — his body is providing the answers, involuntarily.

Muscle Reading can be used simultaneously with any other skills that can be used while touching someone. A person skilled in both Muscle Reading and Detect Lies may appear to be telepathic!

**Psionics (Mental/Very Hard)**

**No Default**

The *science* of telepathy; the basis for psionic engineering, the design of telepathic devices like the Golden Meteor of the Triplanetary Service and thought screens. Since the scientific basis of telepathy is well known, study of this skill does not require the student to be telepathic.



# ● ECONOMICS, JOBS AND WEALTH

The currency of Civilization is the *credit*, which will be represented here by the symbol '\$.' A credit is subdivided into ten decos, each of which consists of ten centos. A centos can be further divided into ten millos, but prices are never specified to the millos; rather, millos are used to pay sales tax. Throughout the Boskonian War, sale tax is calculated at ½%, rounded down: an item that costs up to nineteen centos is not taxed, twenty to thirty-nine centos carries a one-millo tax, and so on.

Average starting wealth in Civilization is \$7,500. For many PCs, 80% of this will be tied up in home equity, furniture, clothing, etc., leaving only \$1,500 available to spend on adventuring gear. Of course, a Wealth advantage will increase both a PC's liquid cash and the quality of his home. The average family puts about 25% of their income into some form of savings accounts and war bonds.

Purchases can be made on credit in Civilization in one of two ways. Banks issue *letters of credit*, usually addressed to a specific correspondent bank, stating that it will accept drafts charged in the customer's name up to a certain amount. In cases of particularly favored customers, the limit may be in excess of the customer's deposits with the crediting bank. In this case, the excess amount (if used) will be handled as a long-term loan, at a predetermined interest rate. Commercial letters of credit are often used by importers and exporters to finance the purchase of goods. A *circular* letter of credit, often used by travelers, is one not addressed to any particular bank, and is sometimes called a *traveler's cheque*.

Some retail stores provide lay-away plans, in which a customer may make a deposit (typically 25% of full price) and the store will hold the item, while the customer makes further payments (a minimum of 10% per month) until the item's cost plus a low interest fee is paid.

## Social Status and Cost of Living

Interstellar commerce has so invigorated the economy that income tax is the lowest in history. The exact rate of taxation is adjusted frequently, but as a rough approximation, a married couple making less than \$1,000 a year pays no tax. Between \$1,000 and \$3,000, the tax rate is less than 1%. From \$3,000 a year to around \$7,000, the rate doubles to nearly 2%, and from \$7,000 to \$50,000 it climbs in small steps through 3%. At the height of the War, the very highest income bracket, enjoyed by fewer than a million people galaxy-wide, paid 3.592%.

The cost of living in Civilization is not closely tied to social status. A junior military officer enjoys the same respect as a noted scientist, but at a much lower cost of living. The monthly expenditures listed are for *unsubsidized civilians* and vary widely with employment and locale. Note that cost of living is meaningless to Unattached Lensmen, since they may charge *anything* to the Patrol.

Typical social levels and cost of living in Civilization:

- 3 .....Space-louse, prostitute: \$50
- 2 ..... Meteor-miner, dole recipients: \$50
- 1..... Pulp fiction writer, servants: \$100
- 0..... Ordinary citizen: \$200



- 1 .....Military enlisted, technician, police officer: \$400
- 2 .....Engineer, scientist, junior officer (nonLensed), city official: \$800
- 3 ..... Junior Lensman, senior officer (nonLensed), minor media figure: \$1,500
- 4 .....Senior Lensman, flag officer (nonLensed), ambassador: \$2,500
- 5 .....Flag Lensman, planetary president, media figure: \$5,000
- 6 .....Unattached Lensman, Regional Coordinator: (not applicable)
- 7..... Galactic Coordinator, Second-Stage Lensman: (not applicable)
- 8 .....Red Lensman: (not applicable)

In general, every two levels of military rank confer one level of social status, and a Lens adds an additional level.

## Job Table

"+RB" with the monthly wage indicates that room and board are provided.

## Critical Failure Key

"LJ" stands for Lost Job — you were fired, demoted or lost the client. "A" stands for Arrested — you fell afoul of the law, and were charged with a crime. The "d" indicates dice of damage — you were in an accident, fight, etc. The "i" indicates a lost month's income ("2i" means losing 2 months' income) — you were fined, forced to pay for damages, had to replace equipment, etc. If there are two entries separated by a "f", use the second result *only* when a natural 18 is rolled.

Note that for some dangerous jobs, the result of a critical failure can be serious injury. The GM may choose to play out these episodes to give the PC a fighting chance.

**Jobs (Required Skills), Monthly Income****Success Roll****Critical Failure****Poor Jobs**

Ditch-Digger (ST 9+), \$40	12	LJ
Dole Recipient (none), \$35	10	-1i
Gang Member* (Streetwise 10+, any combat skill 10+), \$65	Worst PR	-1i, 2d/-1i, 6d, A
Meteor-Miner* (Vacc Suit 10+), \$10x3d	PR	2d/5d
Pulp Writer* (Writing 10+) \$15	PR	-1i/-3i
Servant/Domestic (none), \$30+RB	12	LJ/LJ, 1d
Space-Louse* (none), \$10	12	-1i/3d
Street Walker* (Streetwise 10+), \$30	PR	-1i/2d

**Struggling Jobs**

Author (Mainstream)* (Writing 13+) \$100	PR	-1i/-3i
Barber* (Professional Skill: Haircutting 12+), \$75	PR	-1i/-1i, 1d
Burglar* (Stealth 12+), \$100	PR	1d/A
Clerk/Typist (Clerical Skills 11+), \$100	12	LJ
Cook (Cooking 11+), \$100	PR	-1i/1d, LJ
House Prostitute (Streetwise 12+), \$50	12	-1i/1d
Janitor (none), \$90	11	-1i/LJ
Junior Officer (Administration 10+, Leadership 10+, Military Rank 3), \$250+RB	Worst PR	-2i/2d
Private/Spaceman (Combat skill 10+, Military Rank 1), \$70+RB	PR	-2i/LJ, 5d
Private Inquiry Agent (PI)* (Streetwise 12+, Brawling 11+), \$100	Worst PR	-2i/-2i, 3d
Sergeant or Petty Officer (Tactics 12+, Leadership 12+, Military Rank 2), \$130+RB	Worst PR	-1i, 2d/-3i, 4d
Struggling Entertainer* (Artistic skill 12+), \$100	Best PR	-1i/-1i, 1d
Teacher (Teaching 12+), \$280	PR	-1i/LJ
Thief* (Streetwise 11+, DX 11+), \$160	Worst PR	-1i/-2i, A
Waiter/Waitress (Savoir-Faire 12+), \$120	PR	LJ

**Average Jobs**

Bureaucrat (Administration 12+, Politics 12+), \$500	Best PR	-1i, LJ
Call-Girl (Sex Appeal 12+), \$400	PR	-1i/LJ
Chemist (Chemistry 14+), \$530	PR	-1i/LJ
Engineer (Engineer 13+), \$600	PR	LJ
Factory Worker (Appropriate skill), \$200	PR	-1i/LJ
Journalist (Writing 12+), \$450	PR	LJ
Mechanic (any Mechanic 11+), \$400	PR	LJ/LJ, 4d
Nurse (First Aid 13+), \$500	PR	-1i/LJ
Photographer* (Photography 12+) \$450	PR	-1i/-3i
Police Detective (Criminology 12+, Law 11+), \$500	Worst PR	3d/6d
Police Officer (Criminology 11+, Guns (Pistol) 12+), \$300	IQ	3d/6d
Senior Officer (Administration 15+, Leadership 12+, Military Rank 4 or 5), \$350+RB	Worst PR	-2i/2d

**Comfortable Jobs**

Admiral/General (Leadership 12+, Strategy 16+, Politics 12+, Rank 7+), \$700	IQ	-2i/-4i, LJ
Best-selling Author* (Merchant 13+), \$700	PR	-2i/-5i
Civil Servant (Administration-14+, Accounting or Law-12+, Politics-13+), \$650	Best PR	-1i/LJ
Pro Athlete* (Sport skill 15+), \$500	skill	LJ/-5i, LJ
Research Scientist (Any science 14+), \$750	PR	-1i/LJ
Zwilnik Courier* (Holdout 14+) \$600	PR	A/10d

**Wealthy Jobs**

Corporate President (Administration 14+), \$10,000	PR	LJ
Media Celebrity (Acting or Bard or Singing 14+, Charisma 12+), \$7,500	PR	-3i/-10i, LJ
Planetary President* (Administration and Politics 12+), \$10,000	PR	-1i/A
Zwilnik Kingpin (Streetwise 14+, Administration 12+ \$15,000	PR	3d/A

\* freelance job

## CHAPTER THREE

### THE SEARCH FOR THE GUARDIANS: PROLOGUE

*The Arisians knew full well that they would not endure forever — nor did they wish to. In the fullness of time, it would become proper for their race to pass on to the next plane of existence. However, no mature mind simply abandons a responsibility without providing for its continuance. It was clear that new Guardians of Civilization must be prepared.*



While it is inconceivable that an Arisian might be "hasty" or "crude," for this search both rapidity and stealth were essential. Another race was similarly engaged. To say that Eddore intended to dominate the universe is an understatement. "Intention" does not imply inevitability, and not to dominate was utterly inconceivable to any Eddorian. They did not work in person, but rather through echelon upon echelon of higher and lower proxies. Therefore, they too sought out intelligent life. Those races which would serve them were incorporated into the ranks of executives and supervisors. Those which resisted found themselves conquered by others who had been granted irresistible technology by their new patrons, or were simply made to destroy themselves.

The Molders of Civilization watched Eddore's predations and interfered very little. Eddore must not learn that they were being opposed, and so long as their tampering did not render a race extinct, it served to strengthen it — provided also that it did not come under Eddore's hierarchy of dominance. Three of the most mature minds of Arisia, Nedanillor, Brolenteen and Kriedigan by symbol, began the search for intelligent life which could withstand the stress of being prematurely forced into the third level of stability, and Guardianship. They tampered subtly with Eddore's machinations, and carefully selected and husbanded one race each. From foundations laid in the distant past, in far-separated stellar system, grew the greatest union of wildly disparate races ever conceived: The Galactic Patrol.

## ◎ THE GALACTIC UNION'S RACIAL PROFILE SYSTEM

The Galactic Union, faced with the need to efficiently describe the myriad alien races which compose it, developed a simple classification system. A race is described by a series of letters which detail what it breathes, uses for blood, and so on. Because the Galactic Union evolved from the human Triplanetary Service, Tellurian humans are all 'A's. In general, the letters farther through the alphabet from 'A' describe more and more alien characteristics, but in some cases the difference is academic — is cold copper blood more alien than warm? (First thought may indicate that warm blood is more human, but cold copper-based blood occurs in Tellurian species, and warm does not.) The 'Z' classification is reserved for undefined or non-applicable characteristics. Unfortunately, nearly every life-form which has a metabolic extension falls into that classification, so it is impossible for the system to distinguish between creatures as diverse as Palainians, the Eich, Onlonians and winter-phase Ploorans! However, the problem is lessened by the fact that three of those examples are now extinct or nearly so.

The first ten places are Respiration, Circulation, Bodily Aspect, Nervous System, Manipulators, Support, Integument, Locomotion, Digestion and Reproduction.

## ◎ THE SEARCH FOR THE GUARDIANS, PART ONE

Brolenteen soon found heartening news. Palain VII supported a civilization, already city-dwelling, which apparently had spontaneously evolved! Most other species of the galaxy had been created from Arisian life-spores, but Arisia had never supported life which could also survive on Palain VII. The Palainians were, unfortunately, far from the top of their world's food-chain, but their high intelligence and natural powers of the mind were well worth nurturing. Arisian help would make the necessary difference.

### Palainians

ZZZZZZZZZZ

A Palainian, like all life that thrives a few degrees above absolute zero, "possesses an extension into the hyper-dimension; and it is this metabolic extension alone which makes it possible for life to exist under such extreme conditions. This extension makes it impossible for any human being to see anything of a Palainian except the fluid, amorphous, ever-changing thing which is his three-dimensional aspect of the moment; makes any attempt at description or portraiture completely futile." This *fractional dimensionality* (or "fractality") had been modeled mathematically centuries before, but until the Palainian colony on Pluto was discovered, it had never been imagined that life could rely on it. A mental image of fractional dimensionality can be built by imagining a two-dimensional sheet (of ideal paper, perhaps), crumpled into a ball. The sheet still possesses only two dimensions, but it is "extended" into the third. Palainianoid life is, in a very loose sense, similarly "crumpled up" into a fourth spatial dimension.

Palainians have four sexes, designated *one*, the prenuptial catalyst, *two*, the protective or "mother" sex, *three*, the aggressive or "father" sex and *four*, the postnuptial catalyst. Any of these may be Lensmen except *ones*. No sexism is involved; *ones* are nearly immobile.



Palainians' fluctuating and frequently discontinuous Appearance can be quite upsetting and even Hideous (-20 points). Palainians are physically inept, with ST -2 (-15 points) and DX -1 (-10 points), but they are extremely intelligent: IQ +3 (30 points). All metabolic needs are provided by their fourth-dimensional extension; a Palainian Doesn't Eat or Drink (10 points), and oxygen (a strongly paramagnetic pale blue ore) is a toxin to them: they are completely Anaerobic (-30 points). Thus, around humans, they require Increased Life-Support (-20 points) as protection from both the incredibly high temperature and the poisonous atmosphere. They are Deaf (-20 points) and Mute (-25 points) and have No Sense of Smell/Taste (-5 points).

A Palainian's fourth-dimensional extension makes it very difficult for a three-dimensional entity to determine just where he is, giving PD 2 (50 points). In addition, when threatened, a Palainian instinctively twists his entire body through the hyper-dimension, causing a short translation in three-dimensional space. This effect serves as a Teleport power 10, Emergencies Only (35 points) with the racial skill Combat Teleport at IQ (4 points).

The Palainian melancholy intellect is utterly incomprehensible to a human. They have Weak Will -2 (-16 points) and their aversion to physical danger seems to be craven Cowardice (-10 points). They are absolutely Single-Minded (5 points), getting a +3 bonus on lengthy tasks and a -5 to *notice* interruptions, and Callous (-6 points), caring little about other's feelings and suffering a -2 when using or resisting any social skill. As Loners (-5 points), they require a great deal of "personal space" and react at -2 to others nearby. They have natural power 10 Telepathy (50 points), and the racial skills of Telereceive, Telescan and Telesend at IQ, all with World-Wide Range (5 points each).

In addition, first-sex Palainians are Sessile (-50 points) — they can *be* moved and they have manipulators, but they cannot move on their own. Palainian *fours* suffer from Combat Paralysis (-15 points).

It costs 17 points to be a second-or third-sex Palainian, -33 to be a *one* and 2 to be a *four*.

The three-dimensional cross-section of a Palainian occupies a single hex. Three-dimensional intellects not stable at the third level of stress should not attempt to determine hit-location on a Palainian.

## ☉ THE SEARCH FOR THE GUARDIANS, PART TWO

*Kriedigan soon reported even greater success. The primitives of Rigel IV had already evolved a natural sense of perception as well as a low level of telepathy! They were hardly a perfect candidate race, with abundant and easily available natural resources and no natural enemies. Such an Eden-like environment provided only weak spurs to evolution, so progress in the technologies of weapons and agriculture was trivial. Their gregarious, herd-like societies minimized individualism and curiosity. Such stumbling-blocks could be easily overcome by Arisian inspiration, however.*



## Rigellians

**AABEFDBDGF**

A Rigellian is "physically a monster . . . the oil-drum of a body, the four blocky legs, the multi-branchiate tentacular arms, that immobile dome of a head, the complete lack of eyes and of ears. . . ." Mentally, he is just as alien. "And *what* a mind! The transcendent poise; the staggeringly tremendous range and scope — the untroubled and unshakable calm; the sublime quietude; the vast and placid stability, unknown and forever unknowable to any human or near-human race!"

That serenity is actually the race's major handicap. While it is true that "no Rigellian is, or ever will be or can be . . . 'corrupt' or 'corruptible,'" the "qualities 'force' and 'drive' are fully as rare among [Rigellians] as absolute mental integrity is among [humans]."

Rigellians' sexes are determined, not at birth, but at puberty. At their equivalent of adolescence, a child chooses to be male, female or neuter. Society provides psychological testing services and sometimes puts a great deal of pressure on children to become one sex or another. This process has roots in the distant past, when Rigellians were herd animals, and used this mechanism to control population pressure. Rigellian females cannot be Lensmen.

Rigellian children are raised in groups of three, called "unit-clusters," which frequently develop close psychic ties. During the Boskonian War, Rigellian society dictated that a "perfect" unit-cluster would become two males and one female.

Rigellians have an ugly Appearance to humans (-10 points). Their world's gravity is double that of Tellus', giving the natives ST +1 (10 points) and three levels of Increased ST (150 points) for an average ST 44, thrust damage 5d, swing 7d+1, Increased Speed +2 (50 points) and Reduced Move -2 (-10 points). They stand some seven feet tall on four heavy legs (5 points). Their four tentacular arms (20 points) are each three yards long (80 points) giving +2 to swing damage and +4 to grapple. Their arms have Full Coordination (150 points) and Extra Flexibility (10 points — arms only; their bodies are not flexible at all). Rigellians are Deaf (-20 points), Mute (-25 points) and Blind (-50 points), relying on their Sense of Perception (100 points). They have natural power 5 Telepathy (25 points), and the racial skills of Telereceive, Telescan and Telesend at IQ, all at World-Wide Range (5 points each).

Rigellians are stolid and phlegmatic. They are Unfazeable (15 points), have Honesty (-10 points) and Truthfulness (-5 points) and Weak Will -4 (-32 points). They are also Obdurate (-10 points), actively disliking novelty and reacting at -3 to new things. They must roll IQ-3 to *bother* investigating something new. They are also Hidebound (-5 points), suffering -2 on skills involving creativity or invention. Rigellians "take, practically always, the line of least resistance."

A Rigellian is a three-hex creature, with arms reaching anywhere within four hexes beyond that. Racial cost is 453 points.



## ◎ THE SEARCH FOR THE GUARDIANS, PART THREE

Nedanillor made the best discovery of all. All life on Velantia III was competitive and viciously hostile. The dominant race was physically tough, mentally capable, and surrounded by natural predators. There was no doubt in any Arisian mind that the next Guardians had been found. The other two races would still be cultivated, but as backups only.

### Velantians

### AACBDWMCLH

A Velantian is “a nightmare’s horror of hideously reptilian head, of leathern wings, of viciously fanged jaws, of frightfully taloned feet, of multiple knotty arms, of long, sinuous, heavily-scaled serpent’s body.” Coming upon one unexpectedly (or worse, having one come upon *you* unexpectedly) calls for a Fright Check.

A Velantian’s appearance is Horrific (-30 points). They have Increased ST (50 points), Increased Speed +1 (25 points), Enhanced Move for both running (20 points) and flying (20 points) and 5 Extra HP (25 points). The entire thirty-foot length of their serpentine bodies has Extra Flexibility (10 points) and is armored with a scaly hide which has PD 3 (75 points) and DR 4 (12 points). Their enormous bat-like wings allow Winged Flight (30 points). They enjoy wild aerobatics (Flight skill at DX) and have Acceleration Tolerance (10 points).

Velantians are utterly fearsome fighters, with a formidable array of natural weapons. They have no legs, and six arms (40 points). Their fangs, tail and talons all do either thrust/impaling or swing/cutting damage (40 points). Their bony foreheads can also strike, doing thrust/crushing damage (5 points). The scimitar-like blade on their tails (5 points) has a 3 hex reach (15 points). Finally, their entire bodies can be used in a constriction attack on any creature smaller than five hexes (15 points).

Velantians have eight retractable stalked eyes, independently focusable in four pairs (45 points). They have Full Coordination (100 points) with each of their forelimbs and their tail (which can only strike and grip clumsily — it is not a manipulator). They have natural power 15 Telepathy (75 points) and the racially learned skills Telereceive, Telescan and Telesend with System-Wide Range at IQ level (5 points each). With innate telepathy, they never evolved hearing or speech — they are completely Deaf (-20 points) and Mute (-25 points). They are Very Curious (-10 points), feeling *compelled* to investigate anything strange and requiring a Will-3 roll to avoid it. Millennia of subjugation by the Overlords of Delgon have given the race Weak Will -6 (-48 points) and made them Manic-Depressive (-20 points), their basically sanguine natures alternating between ebullient and fatalistic.

Velantians may have one further disadvantage, depending on the time-period being played. Prior to the introduction of the thought-screen, the Overlords of Delgon held them in Subjugation (-20 points). After the thought-screen came into use, the Overlords’ assaults greatly increased as they tried to stamp out the resistance. Prior to the Galactic Patrol’s arrival, the race has Enemy: Overlords of Delgon (-40 points). With the help of the Patrol, the Overlords were quickly reduced to scattered clutches, nullifying the disadvantage. Racial cost for a Velantian therefore varies between 419 and 479 points.

A Velantian is a ten-hex long creature, but is so flexible that those ten hexes can loop and overlap each other — a Velantian can literally tie himself in knots! His arms issue from hexes 2, 4 and 6 of his body and can reach into adjacent hexes. His eye-stalks can also stretch a full yard, so a Velantian easily peek around corners by exposing a very small part of himself. His wings span 40 hexes, are connected to hexes 3-6, and broaden to a six-hex chord at their widest point. They fold compactly onto his back and take no extra room. Velantians average about a foot long per point of ST and weigh about 50 pounds per foot of length, but players are free to select size for their characters, within reason.

### Arisians

### N/A

Arisians were once similar to A-type races but have evolved beyond physical bodies. They are immortal and utterly invulnerable to physical force, however applied. Mental violence alone poses any threat to an Arisian. Their intellects are stable at the third level of stress and their telepathic powers have universal range.

Arisians are meddlers, tampering with races’ evolutions across the galaxies. However, they are *aloof* meddlers; they almost never interfere on a personal level. They willfully subject their breeding stock to catastrophes which kill thousands of millions of innocent, intelligent individuals. Their only goal is the improvement of the entire race.

Arisians have developed a racial Visualization of the Cosmic All which allows them to predict, to any level of detail desired, the consequences of any event. Their precision decreases with the time-period predicted; after a few thousands of millennia, errors amounting to nearly one part in one hundred thousand million have been observed. Minds advanced to the second stage or beyond *which are attempting to be unpredictable* affect accuracy as well. Specifically, predictions of the actions of Eddorians cannot be given high confidence.

### Chickladorians

### AAAAAAAAAAAA

The most obvious characteristic of Chickladorians is their color. They are pink. Not the pink of red blood through pale skin, but an opaque pigment coloring their entire bodies. Teeth, hair, skin and nails — even most of their triangular eyes, which have three lids instead of two — are brick-reddish pink. A very few women of the race have dusky green eyes; they may be ugly or exotically attractive, but they cannot appear Average.

Chickladorians have +4 DX (45 points), with phenomenal reaction times. They are not naturally telepathic, but they think on a little-used band, making them very difficult to Telereceive and giving them effectively Secret Communication (20 points). They have the racial quirks Pink (-1 point) and Culturally Inclined to Wear Very Little (-1). It costs 63 points to be a Chickladorian.

Chickladorians are one-hex humanoids.

### Delgonians

### AACDDWQCLH

Delgonians are physically quite similar to Velantians — as similar as Martians or Venerians are to Tellurians. They have a Horrific Appearance (-30 points), slightly resembling Tellurian crocodiles with apish heads, some 20 feet long and armored with a scaly hide which has PD 1 (25 points) DR 2 (6 points).

Delgonians are capable hand-to-hand fighters, though their unnatural mental development has caused them to devolve physically, and they are not comparable with the formidable Velantians. They have six limbs, the rear two pair (5 points) used only for walking, the forepair solely as manipulatory hands. Their tail (5 points) has a 2 hex reach (10 points) and strikes for thrust+2 crushing damage.

Delgonians have eight eyes on short stalks, giving 360-Degree Vision (25 points). They have natural power 20 Telepathy (100 points) and the racially learned skills Illusion, Suggest, Telereceive, Telescan and Telesend with System-Wide Range at IQ+2 level (10 points each) and Mind Shield at IQ level (4 points). With innate telepathy, they never evolved hearing or speech — they are completely Deaf (-20 points) and Mute (-25 points).

A Delgonian is a Bully (-10 points) and practices Sadism (-15 points), abducting and torturing to death sapient beings.

While Delgonians are omnivores, they also have an appetite for pain. This Lifeforce Consumption (5 points) is not a naturally-evolved hunger; their race was genetically altered by the Eddorians. It is indulged by first succeeding in establishing a Telereceive link by 5 or more and then torturing the victim to death. This advantage blocks all the shock, stun and Fright Checks normally associated with such a Telereceive, and converts the agony of the victim into indescribable ecstasy for the Delgonian. Every point of damage inflicted restores a point of fatigue to the torturer. Points over maximum are lost, and a maximum of one fatigue point per minute can be recovered.

After the Patrol gave portable thought screens to the Velantians, Delgonians acquired another disadvantage — Enemy: every Velantian, fairly often (-30 points). Their racial cost is therefore either 135 or 105 points.

A Delgonian is a seven-hex long creature. His arms issue from hex 2 and his legs from hexes 3 and 5 of his body, and can reach into adjacent hexes.

## Dhilians and Nhalians

## AAUKQPPIJL

Dhilians and Nhalians are essentially identical. Their lower bodies are something like a Tellurian elephant, with four thick legs (5 points) but no ears or tusks. Their trunks are shorter than an elephant's, and divides at the tip to form a dexterous hand (10 points). Between two wide eyes is a large human-appearing "Roman" nose. This is called the "feeding" head.

From the back of the elephantine body rise two pairs of heavy shoulders with four powerful arms (20 points) and a heavily armored "thinking" head. It has no nose or mouth, but does have four pair of eyes spaced equally around it, giving 360-Degree Vision (25 points). There is no flesh over the bone of this head, and the massive skull is frequently sanded, polished, decorated with enamel and inlays, and lacquered. They have Increased Strength (50 points), 10 Extra Hit Points (50 points), and HT+10 (175 points).

Dhil and Nhal have been at war for many generations. Each side has the other as Enemies, appearing quite rarely (-20 points).

Dhilians and Nhalians mass some 500 pounds. They are four-hex creatures, able to reach into any of the six hexes forward of them. Being a Dhilian or Nhalian is a 315-point advantage.

## Eddorians

N/A

Eddore is inexplicable. It did not originate in normal space-time at all, but rather is from alien and horribly different other space. It "is large and dense, its liquid a poisonous, sludgy syrup; its atmosphere a foul and corrosive fog."

Eddorians are as incomprehensible and as difficult of description as their planet. Their bodies are plastic and entirely subject to their will. They are as completely without sex as Tellurian yeasts. When an Eddorian mind approaches saturation, it simply divides into two, each of which possesses all the memories of their "parent." They are, except for death by mental violence, immortal. They are absolutely invulnerable to *any* level of physical violence.

Eddorian minds are every bit as impossible to describe. "[I]ntolerant, domineering, rapacious, insatiable, cold, callous, and brutal . . . keen, capable, persevering, analytical, and efficient. . . . No Eddorian ever had anything even remotely resembling a sense of humor." They do not love to kill, but they are not averse to it, either. Precisely the amount of bloodshed necessary to achieve a goal is desirable. More or less is inefficient. Every member of the entire Eddorian race has one single goal. "The same one: power. *Power!* P-O-W-E-R!!" They are stable at the third level of stress and their telepathic powers have universal range.

## Eich

ZZZZZZZZZZ

An Eich is "a many-tentacled creature . . . not like an octopus. Though spiny, it [does] not resemble at all closely a sea-cucumber. Nor, although . . . scaly and toothy and wingy, [is] it, save in the vaguest possible way, similar to a lizard, a sea-serpent, or a vulture." It is intrinsically "indescribable to man," and its racial point value is incalculable by GMs. It is a confusedly horrible blue.

Unlike Palainians, an Eich's three-dimensional part is fixed. Aided by telepathic illusion, an Eich in refrigerated armor can pass for a Velantian (above).



Eich are superb engineers, their mastery of the physical sciences unparalleled anywhere in the galaxies. They provided Boskonian with the vast majority of its technical breakthroughs in war systems, including the hyper-spatial tube.

Eich have high IQs, Second-Stage Stability and natural Telepathy of high power, with the racial skills of Mind Shield and of Telereceive, Telescan and Telesend at System-Wide Range.

Eich have Bad Temper and Bloodlust. They are Fanatic, Megalomaniac and Overconfident. They are completely Self-Centered, reacting at -6 to any slight, real or imagined. They do not truly consider anyone but themselves to be of any significance whatsoever: their attitude is utterly Solipsistic, making them -3 to use or resist Fast-Talk or any social skill. They are utterly Xenophobic, reacting at -5 to any outsiders.

Eich suffer from the racial quirk of Unreasonable Realism: they cannot understand anything they can't measure. This flaw caused their extermination when they "attempted to subject a purely philosophic concept, the Lens, to a mathematical analysis" and then based their decisions on the meaningless data so generated. The names (or titles — the difference is moot) of individual Eich include the race name; such as Ynstk of the Eich, or Eichynstk for short.

GMs are encouraged to expand the Eich from these basic characteristics in diverse ways. The Eich have no compunction against altering their own biological makeup, and have "engineered" sub-races with different attributes. Players encountering Eich will be outclassed in nearly every way. If they prevail, it should be because of the Eich's ego and other mental disadvantages, and the aid of the Lens. It will certainly *not* be because the Eich did something stupid or was lacking in the finest equipment.



## Jovians

**AAAAAEEAA**

Jovians, like Martians and Venerians, are closely related to Tellurians, but have evolved along a different path because of their native environment. They are very short and fat, and are frequently compared, unflatteringly, to hippopotamuses. Jupiter's surface gravity is more than double Tellus', and Jovians have gained two levels of Increased Strength (100

points) and DX+2 (20 points) to cope with it. To see in the gloom beneath Jupiter's dense atmosphere, they have Dark Vision (25 points). Their thick and rubbery skin has DR 1 (3 points), PD 1 (25 points) and provides Pressure Support (15 points). They have a Dependency (-40 points) on ammonia — if an hour passes without them getting several good lungs-full, they begin losing 1 HT point every ten minutes. They smell strongly of ammonia, which contributes to their overall Ugly Appearance (-10 points).

The Jovians fought a series of bitter wars against the Triplanetary Service in the early days of space flight, before the invention of the Bergenholm. Some of the most feared opponents of the Service were the Adepts of North Polar Jupiter. An enclave of monastic ascetics, also called the Forbidden Society, they developed the powers of their minds and bodies to their ultimate. After the Jovian Wars, the Adepts fragmented into a score of competing schools, some adherent to the Solarian League and some renegade, and much of their teachings was lost. To locate a true Adept in the days of the Galactic Patrol would be a major undertaking — but if he can be persuaded to pass any of that knowledge on, well worth it.

The Forbidden Society was finely ranked, with seventy-seven degrees of status. The standard methods of earning promotion resembled Eddorian advancement procedures: assassination of one's seniors was a common technique. Adepts of any rank had high basic attributes, were frequently telepathic and always were very skilled in the martial arts and other disciplines of the body. Most were easily identifiable by a complex, multichromatic cabalistic tattoo. Among other skills, they perfected the science of muscle reading (see p. 33). Their marksmanship with all weapons including those of their spaceships was supernally fast and accurate. Adepts of the seventy-seventh level are supposed to have acquired the advantage of Unaging . . . but this report cannot be considered reliable. The only Adept known to achieve that high rank was Gray Roger, now known to be Gharlane of the Innermost Circle of Eddore.

GMs who want to have the Adepts of North Polar Jupiter active in their campaign are encouraged to use *GURPS Martial Arts* to describe their school in detail. Most of the cinematic advantages and skills from that book are appropriate for a high-ranked Adept.

It costs 138 points to play a Jovian — and much more to play an Adept.

## Kalonians, Tomingans, etc. **AAAAAEEAA**

There are a great many races throughout the galaxies which are human to ten or more places, differing only in subtleties such as skin color and bodily strength. Many of them have powerful mental capabilities. GMs should feel free to develop the physical, psychological and sociological details of any of these races as desired, but in no such case will Mentor give Lens to humanoid females, regardless of their abilities. See *History and Society* for a discussion of his reasoning. All are one-hex humanoids.

## Lyranians **AAAAAEEAA**

A Lyranian person's Appearance would be Beautiful (15 points) *if* it would pay any attention to trivia like combing its hair. However, it has the Odious Racial Habit of Never

Grooming (-10 points) — if a lock of hair gets in its face, it simply cuts it off at the first opportunity. Lyranians have natural power 10 Telepathy (50 points), and the racial skills of Telereceive, Telescan and Telesend with System-Wide Range at IQ+2 (10 points each) and Mental Blow, Mental Stab and Mind Shield at IQ (4 points each).

A Lyranian's Xenophobic (-15 points) nature is legendary and its Intolerance (-15 points) of male humanoids is worse (as is illustrated by its use of the genderless pronoun). It suffers from Stubbornness (-5 points) and is Self-Centered (-10 points) and Callous (-6 points). It has the Odious Racial Habit of Demands Political Correctness (-5 points) and the racial quirks of Unable to Comprehend Beauty (-1 point) and Never Wears Anything Unnecessary (-1 point). In Lyrane II's pleasant climate, this latter quirk results in the population being completely nude at almost all times. Being a Lyranian person is an 39 point advantage.

A Lyranian male suffers from Dwarfism (-15 points); he is about thirty inches tall. He is Berserk (-15 points), has IQ -6 (-50 points), and a Slave Mentality (-40 points). Being a Lyranian male is a -120 point disadvantage.

All Lyranians are one-hex humanoids.

## Martians

## DAAAAARLDA

Mars' hostile environment has produced a race with Decreased Life Support (10 points) needs. In particular, their water requirements are small; a few ounces a month is a luxury. They are also quite Temperature Tolerant (20 points), comfortable from well over a human's "room temperature" to below the chill of the Martian night — HT×10+25° F on either side of -25° F. However, Mars' gravity is only one-third that of Tellus, and Martians have ST-6 (-50 points). Their bodies are well protected from the harsh Martian environment. Their thick and rubbery skin is a nearly perfect insulator and moisture barrier, but it has No Sense of Touch (which includes High Pain Threshold; -20 points). It is overlaid with a chitinous armor which confers PD 1 (25 points), DR 2 (6 points). Their eyes are covered by a four-layer Nictating Membrane (10 points) set which gives their eyes PD 2, DR 1 against sandstorms or any other physical damage and act as Polarized Eyes (5 points) against flashes of light. They are one-hex humanoids.

The Martian race is ancient, with an intricate and highly formal society. Martians are thoughtful and considerate, carefully weighing all aspects of a situation before acting. They frequently seem ponderous and dull to humans, while humans appear suicidally rash and impulsive to them.

The Martian race is worth 6 points.

## Nevians

## CPUSWYXXWB

A Nevian's horizontal, flounder-like body is covered with scales giving DR 1 (3 points), is supported by four short, powerful, flat-footed legs (5 points) and terminates in a four-vaned tail like a capital letter "X." A long and flexible neck, carried in loops and curves which are very expressive (to other Nevians) supports a head like a conical spear-point. They have four large triangular eyes, spaced equidistantly around that cone and protected by Nictating Membranes (10 points). Behind each eye springs a tentacular arm (20 points) with Extra Flexibility (10 points, but just the arms, not the whole body) which divides at

its end into eight fine and strong fingers. Behind each arm is a tusked mouth, and behind it, under the trailing edge of the cone are the organs which serve either as Gills (10 points) or nostrils. They are Amphibious (10 points) and have a Dependency (-20 points) on water — in one hour in dry air, their skin dries out and they begin losing 1 HT per ten minutes. Their speech and hearing are ultrasonic only, giving them Secret Communication (20 points).

Their repugnant smell like over-ripe fish contributes to a Hideous (-20 points) appearance to humans, but that smell can be masked with creosote, which Nevians consider very pleasant. They are an unemotional people, reasonable, calculating and passionless. They are fastidious, cultured and talented — quite difficult for humans to really *like*.

Nevians are a 48-point race.

## Onlonians

## ZZZZZZZZZZ

To any strictly three-dimensional mind, all life which relies on a metabolic extension into the hyper-dimension is subtly incomprehensible. Accordingly, to the perceptions of warm-blooded oxygen-breathers, Onlonians are essentially identical physically to the Eich. According to the Palainian Institute of Technology and Science, the primary differences between the Eich and Onlonians are that the Eich innoxize during togiles while Onlonians whariate, and Onlonians emmfoze with their diehlada in ommad, which is obviously impossible for an Eich.

The physical advantages and disadvantages of Onlonians are identical to the Eich's. Mentally they are quite different. Onlonians are IQ+6, Intuitive Mathematicians, and have Second-Stage Stability. They have great powers of Telepathy with the racial skills of Illusion, Mental Blow, Mental Stab, Mind Shield, Mindwipe, Sleep, Suggest and Telecontrol and of Telereceive, Telescan and Telesend with Interstellar Range. Their knowledge of the sciences of Psionics and Psychology is unparalleled.

GMs are again encouraged to expand the Onlonians from this basic information in varying ways. While physically they are not particularly powerful and are unlikely to be surprising, it will be all but impossible to engage them in any physical way. With their superb mastery of all the mental sciences and disciplines, they are most at home in the shadows behind the scenes. They do not become embroiled in hand-to-hand combat, they send the Delgonians. They do not assault a world, they order the Eich to develop new weapons of unimaginable power and to use them. Any entity of less than the second level of mental ability encountering an Onlonian will be instantly overpowered. Nadreck, the master psychologist and psionist of all the galaxies, was unable to mentally defeat three high-ranking Onlonians in several months of effort, and was forced to destroy them physically.

## Ploorans

## Various

Ploor orbits a star so variable that it periodically covers practically the entire possible range. Its weather is starkly unpredictable and indescribably harsh, varying from nearly 400° F to -450° F. In the spring violent floods completely submerge its surface and terrible storms begin, which last through summer and climax in unbelievable frenzy in autumn. All life on its planets has evolved the ability to rapidly change form to adapt

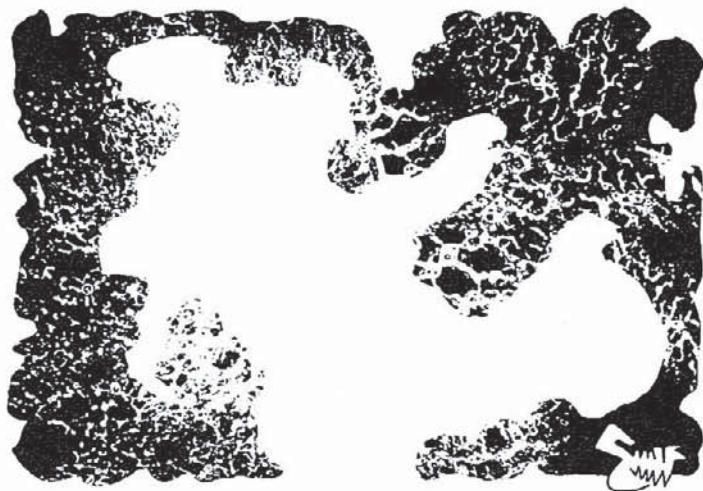

to the prodigiously different environments in which it may find itself. The dominant race of the planet has four major forms, identified by a seasonal name. This nomenclature may be slightly confusing, since they do not necessarily occur in the standard order. Ploor's sun can flare, for example, after a quiescent, cool period. The Ploorans would be in their winter phase, but the sudden increase in radiation would cause them to move into their spring phase sooner than expected. If their sun then subsides, they will revert back, changing directly from spring to winter.

A Plooran's form is externally controlled; it is not voluntary. As long as the triggering conditions exist, it will remain in the same phase. The phase-change takes a matter of hours, during which the Plooran suffers all of the disadvantages of both phases.

Ploor is a large and heavy planet, and Ploorans are strong and fast in all their forms. They think on a terrifically high telepathic band, and their thought patterns are very alien. In particular, their winter phase is purely four-dimensional, utterly incomprehensible by any three-dimensional life. Ploorans evolved in the harshest environment ever known to support life of any sort, and developed an intelligence every bit as hostile and cruel as their world. They are brilliant intellects with commands of both technology and psychology exceeding any other native to these galaxies. When His Ultimate Supremacy, the All-Highest of Eddore appointed the Plooran race to be the utmost Proxies of Power, the Inner Circle was concerned that they would be too difficult to control and too dangerous to have close connections to Eddore itself.

GMs should use the Ploorans with great care. One to one, they outclass any entity at less than the third level of development. They are more technologically advanced than the Eich, more mentally capable than the Onlonians, and suffer none of the faults of ego of either of those races. A Plooran, unlike nearly any other race in the hierarchy of Boskonian, is capable of saying "I have made a grave error in thinking that you are not at least my equal. Will you grant me pardon, please?" This ability makes a Plooran a fantastically dangerous foe, one which will starkly annihilate any imaginable party of player-characters.

### **Spring**

**TUUWVYXXWT**

A Plooran's amphibious spring form is physically much like a Nevian, with a flat, fish-like body standing on four short legs. They do not have the long looping neck of a Nevian, though; their head is one with their body, they have no eyes and their four arms are arranged more bilaterally.

### **Summer**

**RTSLQPRSTR**

In their summer, Ploor's sun is a blue giant, and Ploorans become rather like Dhilians, with a squat, powerful elephantine body supported by four stocky legs, and double shoulders with four enormous arms. The resemblance ends there. They have only one domed head almost immobile between the heavy double shoulders, and it is not as bony as the Dhilians'. They have no eyes or trunk. They neither eat nor breathe. Their skin is remarkable, a more efficient insulator and pressure barrier than a Martian's.

### **Autumn**

**VWZYTXYZY**

As Ploor's sun subsides from its blue giant stage, it passes through a yellow dwarf phase, and Ploor itself cools to the point of carbon dioxide snows. Ploorans in the autumn are multi-legged, carapaceous and spiny. Their world is cold, dismal and barren, but not utterly frigid. They have been described as looking like "warm-blooded Palainians," as nonsensical as that phrase may be.

### **Winter**

**ZZZZZZZZZ**

As their planet cools to near zero absolute, Ploorans shift the entirety of their metabolism into the hyper-dimension. Their visible aspect becomes obscure, fluid, amorphous and indefinite. They appear discontinuous and fluctuate greatly in apparent size.

### **Posenians**

**AAAGCABEXA**

A Posenian is basically a one-hex humanoid, except for having four arms (20 points), two springing from each massive shoulder. Each arm ends in two hands (20 points), and each hand has two thumbs. This arrangement gives an exceedingly strong grip. He is Blind (-50), having no eyes at all and relying on his Sense of Perception (100 points). His inflexible neck is short, massive and tremendously strong. His face holds two broad flat noses and two toothy mouths, and is framed by large shell-like movable ears, giving Acute Hearing +2 (4 points). Posenians are chlorine-breathers, and oxygen is extremely toxic to them. They are Anaerobic (-30 points) and require Increased Life-Support (-10 points).

Posenians, like many other races with senses of perception, make excellent doctors, since they "can see into the patient without taking him apart." They are responsive, sensitive people, readily imagining the feelings and motivations of others, though they habitually expect similar consideration in return. Several of the best strategists on the Patrol's Grand Fleet Operations staff are Posenians.

Being a Posenian is a 54 point advantage.

### **Vegians**

**AAAABAACAA**

Vegians are an Attractive (5 points) panther-like people, with vertical slit pupils to their eyes, tall pointed ears, short

retractable claws on their hands and feet (15 points) and a long and sinuous tail. That tail, a reliable barometer of their moods, is completely prehensile, with Extra Flexibility but No Physical Attack (10 points). They engage in Compulsive Grooming (-5 points) and have Strong Xenophobia (-15 points). They have Increased ST (50 points), DX +4 (45 points), Discriminatory Smell (15 points), Ultrahearing (5 points) and the racial quirks Must Voice Sibilants (say 'Z' for 'S') and Culturally Inclined to Wear Very Little (both -1 point). Racial cost is 123 points. Vegians are one-hex humanoids.

## Venerians

## AAAAAANBCA

Venerians are an Amphibious (10 points) one-hex humanoid race resembling Tellurian seals. They prefer an atmosphere nearly double in pressure to that of Tellus, with far more carbon dioxide, at nearly 100% humidity and around 110° F. They can tolerate the frigid, dry air of Tellus for short periods, but have a Dependency (-20 points) on water to keep their skin moisturized — if an hour goes by without it, they begin losing 1 HT per ten minutes. They have very Acute Taste and Smell (5 levels, 10 points). Their throats and stomachs are tough and flexible, so a Venerian can “swallow anything one inch smaller than a kitchen stove” and regurgitate it at will later (5 points).

They are a sensuous, fun-loving, rather frivolous people who can exasperate a human unused to their ways. They are highly intelligent, but believe in keeping all parts of life in their proper times and proportions. If now is the time to chase fish, there is no point in trying to discuss anything — the time for discussion is later.

Being a Venerian is worth 5 points.

## Valerians

## AAAAAAAAAAAA

Valeria was settled a decade before the Lens was given to humanity. “[W]herever diamonds are, there go Dutchmen. And Dutch women go wherever their men do. And, in spite of medical advice, Dutch babies arrive. Although a lot of the adults died — three G’s is no joke — practically all of the babies [lived]. Developing bones and muscles to fit — walking at a year and a half old — living normally . . . the third generation [was] perfectly at home there.”

Soon Valeria supported a thriving race, producing the most fearsome warriors the galaxies had ever seen. A Valerian stands something less than seven feet in height and something over four hundred pounds in weight — under Tellurian gravity. On Valeria, they weigh nearly two-thirds of a ton.

A Valerian is incredibly strong, with a grotesquely muscular body which has an Ugly Appearance (-10 points), ST +1 (10 points) and three levels of Increased ST (150 points) for an average ST of 44. Their reactions are honed by an environment in which things fall much faster than on Tellus, giving them Increased Speed +1 (125 points) and one level of Enhanced Move for Running (20 points). Reduced blood flow to the brain has caused IQ -2 (-15 points). They have Bad Temper (-10 points) and a Reputation -1 as easily provoked brawlers (-5 points). Racial cost is 265 points.

The puniest Valerian of vanBuskirk’s company could do in full armor a standing high jump of over fourteen feet against one Tellurian gravity.

## ● THE SEARCH FOR THE GUARDIANS: EPILOGUE

*While the three minds which were to be known collectively as Mentor searched for the next Guardians, a young Arisian identified as Drounli studied the plains apes on Sol III, only 250 parsecs from Rigel. It was distinctly possible that this particular subspecies could evolve intelligence, if not for the earthquake which would exterminate the entire population a few years hence. Nothing would be done to save them, of course. No Arisian could have any desire to protect weak, defenseless scavengers.*

*But Drounli was watching when something new occurred. Scavenging had been poor. The large predators which provided the remains of their kills had hunted the valley out and had departed for better grounds. The apes were getting hungry. One, who labeled herself in her thoughts as “Daech,” stared hungrily at a herd of tiny, fleet, antelope-like animals. She screamed in frustration and hurled a small rock. The animals shied and ran a short distance, but had learned that the apes, while noisy, were not a threat.*

*But today, something new occurred. Daech bared her teeth and picked up another, larger rock. This one she didn’t throw. She clutched it tightly and bounded toward the herd. Again the antelopes sprang away, easily outrunning the small ape. But she didn’t stop, and again the herd bolted, scattering in all directions. Daech didn’t stop. Fascinated by this inexplicable behavior — Daech’s small intellect was not unstable; she had to realize that the antelopes were far faster than she — Drounli slipped into her mind.*

*Lungs heaving, heart pounding near to bursting, Daech had chosen one particular antelope, utterly at random, and was running for it. Drounli realized that, contrary to all reason, Daech would never stop. She would burst her heart, or catch the antelope — which was now far ahead, and stopping to graze again. Daech neared, and yet again the antelope sprang away — but slower this time; it hadn’t had time to catch its breath.*

*The raw determination in Daech’s mind enthralled Drounli. Never in his entire existence had he encountered such absolutely unquenchable drive! It mattered not the slightest that Daech’s goal was impossible — she had set her goal, and would consider nothing less.*

*The antelope, finally exhausted, stumbled and fell. The rock, driven by the last dynes of strength in a body driven far beyond ordinary capabilities, dashed its brains out. But Drounli’s consciousness was parsecs away.*

*“The one with the red-bronze-auburn fur.”*

*“Another would be also necessary.”*

*“Her brother, called Kinah, is very nearly as stubborn.”*

*“Very well. Though its value is debatable, such unreasoning will in an otherwise intelligent creature should be preserved. No more than their family should be moved, and see to it that their progeny do not cross-breed.”*

*Daech’s mother, Ef, felt an inexplicable compulsion, driving her and her children from the valley where they had always lived. Shortly after their departure, a tremendous earthquake ripped through the valley. Not one of their relatives survived.*

*The fourth, and feeblest, hope of Civilization had started on the long path to Guardianship.*

# SAMPLE CHARACTERS

## ANSON MAYNARD

Lieutenant (Lensman), GP

Male exalted human; age 24; 5'10"; 175 lbs.; glossy black hair, pencil mustache, gray eyes. 445½ points.

ST 14 [45]      IQ 14 [45]      DX 15 [60]      HT 16 [80]  
Speed: 7.75      Move: 9      Dodge: 9

### Advantages

Alertness-1 [5]; Appearance: Handsome [15]; Charisma-3 [15]; Eidetic Memory [30]; Intuition [15]; Lensman [100]; Longevity [5]; Luck [15]; Rapid Healing [5]; Rank-4 (GP Lieutenant) [20]; Strong Will-2 [8]; Reputation-2 (entire Patrol, sometimes) [2½]; Status-3 (GP junior Lensman) [15]; Telepathy-12/4 [60/20] (with Lens/without).

### Disadvantages

Code of Honor (Lensman's Load) [-10]; Enemy (Boskonian — quite often) [-80]; Extremely Hazardous Duty (to Galactic Patrol) [-20]; Fanaticism (Galactic Patrol) [-15]; Honesty [-10]; Lecherousness [-15]; Overconfidence [-10]; Sense of Duty (Civilization) [-20];

### Quirks

Confirmed bachelor and “lady killer;” dislikes “slipstick creeps” — scientific, engineering or technical professionals; eager to talk about conquests — but his stories are always completely fictitious (he *never* talks about his real girlfriends); hostilely impatient with displays of sexual inhibitions; is creating a private collection of (beautifully drawn) portraits of his girlfriends.

### Skills

Acting-14 [½, from Performance], Administration-15 [2, from Merchant], Artist-16 [4], Astrogation-14 [1], Bard-15 [2], Battlesuit-14 [½, from Vacc Suit], Beam Weapons (DeLameter)-18 [8], Carousing-18 [8], Chemistry-12 [½], Dancing-15 [0, from being Aldebaranian], Diplomacy-14 [2], Electronics-12 [½], Fast-Draw (pistol)-16 [2], Fast-Talk-15 [2], First Aid-15 [1], Free Fall-15 [2], Gambling-13 [½], Holdout-14 [1], Inertialess Agility-14 [2], Integrating Calculator Operation-14 [1], Karate-13 [1], Knife-16 [2], Law-12 [½], Leadership-15 [2], Mathematics-12 [½], Merchant-15 [2], Performance-15 [1-½, from Bard], Physics-13 [1], Piloting (speedster, inert)-13 [1], Piloting (speedster, “free”)-13 [1], Psionics-12 [1], Psychology-12 [½], Running-14 [1], Savoir-Faire-16 [2], Sex Appeal-18 [3], Space-Axe-14 [1], Strategy (space combat)-14 [2], Tactics (space combat)-15 [3] and Vacc Suit-16 [3].

### Military Hand-to-Hand Combat Maneuvers

Back Kick-12 [1], Close Combat (Space-Axe)-10 [1], Elbow Strike-13 [1], Eye Gouging-5 [1], Head Butt-9 [1], Hit Location (Space-Axe)-12 [1], Jump Kick-12 [1], Knee Strike-14 [1], Kicking-13 [1] and Spin Kick-13 [1].

### Telepathy Skills

Mind Shield numbers are with Lens/without. Others are Lensed only.

Mind Shield-13/11 [2½], Telereceive-13 (Interstellar Range) [3], Telescan-13 (Interstellar Range) [3] and Telesend-13 (Interstellar Range, Cannot Lie) [2½].

### Story

His father was a Tellurian Lensman, a cousin of the Kinnison family, who met his mother while stationed on Aldebaran II, married her and made their home there. He was killed in action when Anson was seven years old. Anson remembers his father as an idealized hero. He has no special drive to “avenge” his father, just the conviction that he must continue his work.

Anson's mother tried to raise him in the pacifistic Aldebaranian society. Anson showed some artistic ability, and she enrolled him in art classes, hoping he would become a painter. Anson, however, inspired by the memory of his father, was fascinated by the military and hung around the base, talking to the Patrolmen. Over his mother's objections, he applied to the Academy and entered a few months after his 18th birthday.

Anson's artistic talent served him well in the Academy, once he discovered that he could sell “pin-up” drawings to other cadets. (He also eluded some hazing by not charging upper-classmen.) He has very little scientific ability, and was not a remarkable cadet, graduating 53rd of 97. The Academy's requirement of a solid engineering background has given him a strong distaste for “slipstick creeps.” He learned what he had to, but dislikes academic study.

He has served in the fleet for over a year now, performing better than might be expected from his lackluster scores. He continues to make extra money from his drawings: pin-ups for individuals, murals in the crew spaces and “nose art” for small craft. He usually charges \$200 and a fifth of bolega for nose art, but can be dickered with.

Anson has a reputation as a “lady killer” that is completely deserved. The uninhibited attitudes of Aldebaran II were the only part of his upbringing that stuck with him. He has *at least* one girl in every port. He is punctiliously honorable and frank about his intentions — he is a confirmed bachelor, and will not be “tied down.” Some of his girlfriends may still entertain hopes of “catching” him, but not because he is leading them on.

Anson is aiming his career at Grand Fleet Operations, concentrating on developing his administration, strategic planning and related skills.

### Quotes

“I dunno. The XO's gonna take a dim view if we paint his sweetheart *there*.”

“C'mon, sweetcakes. Put down the book and let's go dancing.”

“Well, no, sir, not *exactly* by the book. Sir, they've *read* the book.”

# KIMBALL KINNISON

*Second-Stage Lensman, Unattached. Galactic Coordinator.*  
Male exalted human; age 49; 6'2", 216 lbs.; gray hair, gray eyes. 4,158 points.

ST 18 [125]    IQ 22 [225]    DX 18 [125]    HT 18 [125]  
Speed: 9.00    Move: 9    Dodge: 9

## Advantages

Alertness-5 [25]; Allies (Clarrissa, all the time [915], Nadreck [325], Tregonsee [335], vanBuskirk [155] and Worsel [360] each fairly often); Appearance (Attractive) [5]; Charisma-5 [25]; Combat Reflexes [15]; Compartmentalized Mind-3 [150]; Eidetic Memory [30]; High Pain Threshold [10]; Intuition [15]; Lensman [100]; Longevity [5]; Luck [15]; Military Rank-9 (Unattached) [45]; Patron (Kathryn Kinnison, fairly often) [120]; Patron (Mentor, rarely) [40]; Rapid Healing [5]; Reputation-4 (all Civilization all the time) [20]; Second-Stage Stability [25]; Sense of Perception [100]; Status-7 (Galactic Coordinator) [35]; Strong Will-5 [20]; Telepathy-31 [155].

## Disadvantages

Code of Honor (Gray Seal) [-15]; Enemy (Boskonian, all the time) [-120]; Extremely Hazardous Duty (Galactic Patrol) [-20]; Fanaticism (Civilization) [-15]; Honesty [-10]; Impulsiveness [-10]; Overconfidence [-10]; Sense of Duty (Civilization) [-20].

## Quirks

Chivalrous, reluctant to "make war on women;" "meat-and-potatoes" man: prefers plain food, and lots of it; reads (and sometimes writes) pulp fiction; swears by Klono's body parts; habitually uses mildly derogatory nicknames for acquaintances.

## Skills

Administration-22 [1], Astrogation-22 [1], Battlesuit-24 [3], Beam Weapons (DeLameter)-23 [24], Carousing-20 [8], Criminology-22 [1], Diplomacy-21 [1], Disguise-22 [1], Fast-Draw (DeLameter)-23 [24], Fencing-18 [2], Free Fall-20 [8], Holdout-22 [1], Inertialess Agility-20 [16], Judo-20 [16], Karate-20 [16], Knife-23 [24], Leadership-24 [3], Motorcycle-18 [1], Piloting (speedster, inert)-23 [49], Piloting (speedster, "free")-23 [40], Prospecting (meteor)-22 [1], Space-Axe-23 [32], Speed-Load-23 [24], Strategy (space combat)-27 [7], Streetwise-25 [4], Tactics (space combat)-28 [6], Vacc Suit-22 [1] and Writing-22 [1].

## Hand-to-Hand Combat Maneuvers — both standard Military and Marine

Aggressive Parry-13 [6], Arm Lock-22 [1], Back Kick-22 [2], Close Combat (Axe)-20 [2], Elbow Strike-20 [1], Eye Gouging-12 [1], Head

Butt-18 [4], Head Lock-20 [6], Hit Location (Axe)-23 [4], Jump Kick-21 [1], Kicking-22 [4], Knee Strike-22 [1], Neck Snap-21 [12] and Spin Kick-22 [1].

## Telepathy Skills

Illusion-30 [40], Mental Blow-25 [20], Mental Stab-30 [40], Mental Blast-35 [60], Mind Shield-25 [10], Mindwipe-28 [32], Suggest-35 [60], Telecontrol-35 [60], Telereceive-22 (Intergalactic Range) [10], Telescan-22 [4] and Telesend-30 (Intergalactic Range, Cannot Lie) [44].

## Story

Kinnison, the human male penultimate, was Released after his first mission. He was the only human to receive additional training from Mentor, becoming the second Second-Stage Lensman. He suffered heavy wounds during his many operations against Boskonian, and met Nurse Clarrissa MacDougall while recovering and repeatedly thereafter. Their superiors in the Patrol and Mentor saw to it that they fell in love.

Stymied by the uncooperative persons of Lyrane II, he assigned that planet's investigation to Clarrissa, whom he made the only human female Lensman ever, to Lyrane II. Kinnison eventually succeeded in infiltrating Boskonian so thoroughly that he became its Tyrant and learned that the real power was the Prime Minister, Fossten. Kinnison led an assault on the Patrol base Ultra Prime, but attacked Fossten at the last moment, discovering that he was a renegade, insane Arisian. Kinnison slew Fossten and surrendered Boskonian to Civilization. He then married Clarrissa, became Galactic Coordinator of the Second Galaxy, and eradicated the fragments — the "Spawn" — of Boskone.

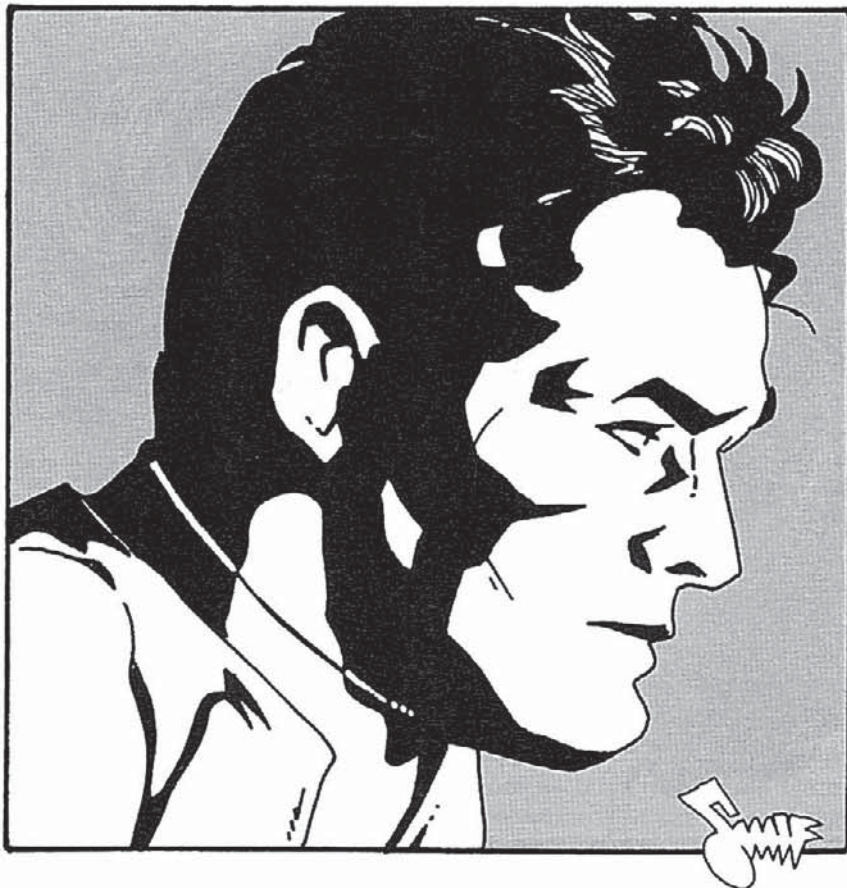



Some twenty years later, disturbing patterns formed. He assigned his son to investigate, assisted by all the Second-Stage Lensmen. Kinnison's characteristic pattern of infiltration discovered a corps of Black Lensmen, but also led him into a series of ambushes specifically designed for him. The first snares he escaped by luck, but he was finally trapped such that Mentor could not locate him. His wife in fusion with their children did, however, and Mentor arranged his return.

### Quotes

"Such a bloated swine; such a mangy, low-down cur; such a pussy-gutted tub of lard; such a brainless, filthy spawn of the lowest dregs of the rottenest scum of space; such an utterly incompetent, self-opinionated, misbegotten abortion as you are. . . ."

"Consider very carefully and very thoroughly an iceberg; its every phase and aspect."

"KLONO'S tungsten TEETH and CURVING CARBALLOY CLAWS!!!!"

## CLARRISSA KINNISON, NEÉ MACDOUGALL

*Second-Stage Lensman, Unattached. Red Lensman.* Female exalted human; age 46; 5'6", 145½ lbs.; red-bronze-auburn hair, gold-flecked tawny eyes. 3,060 points.

ST 14 [45]    IQ 22 [225]    DX 20 [175]    HT 20 [175]  
Speed: 10.00    Move: 10    Dodge: 10



### Advantages

Alertness-5 [25]; Ally (Kimball, all the time [1245]); Appearance (Very Beautiful) [25]; Charisma-5 [25]; Combat Reflexes [15]; Compartmentalized Mind-4 [200]; Eidetic Memory [30]; High Pain Threshold [10]; Intuition [15]; Lensman [100]; Longevity [5]; Luck [15]; Military Rank-9 (Unattached) [45]; Patron (Christopher Kinnison, fairly often) [120]; Patron (Mentor, rarely) [40]; Rapid Healing [5]; Reputation-4 (all Civilization all the time) [20]; Second-Stage Stability [25]; Sense of Perception [100]; Status-8 (Red Lensman); Strong Will-6 [24] and Telepathy-35 [175].

### Disadvantages

Code of Honor (Gray Seal) [-15]; Enemy (Boskonian, all the time) [-120]; Extremely Hazardous Duty (Galactic Patrol) [-20]; Fanaticism (Civilization) [-15]; Honesty [-10]; Phobia (severe, utterly revolted by Arisians) [-10]; Sense of Duty (Civilization) [-20].

### Quirks

Amiable, but pushed far enough, fears nothing; clothes-horse — likes fine clothes; does not believe she deserves her Lens, still less her Gray Lensman uniform and is reluctant to wear either; is inspired to absolute maximum capacity by her Grays; uncomfortable as the center of attention.

### Skills

Administration-22 [1], Area Knowledge (Klovian)-23 [1], Area Knowledge (Brenleer's)-24 [2], Astrogration-22 [1], Beam Weapon (DeLameter)-23 [8], Biochemistry-21 [2], Chemistry-20 [1], Dancing-19 [1], Diagnosis-25 [5], Electronics Operation (Medical Equipment)-25 [4], First Aid-30 [8], Free Fall-20 [2], Inertialess Agility-20 [4], Karate-20 [4], Knife-20 [1], Leadership-22 [1], Musical Instrument (Piano)-20 [2], Physician-25 [5], Piloting (Speedster, inert)-23 [24], Piloting (Speedster, "free")-22 [16], Psychology-24 [4], Riding (horse)-20 [2], Singing-20 [1], Space-Axe-20 [2], Vacc Suit-26 [5] and Xenobiology-22 [1].

### Military Hand-to-Hand Combat

#### Maneuvers

Back Kick-19 [1], Close Combat (Axe)-16 [1], Elbow Strike-20 [1], Eye Gouging-12 [1], Head Butt-15 [1], Hit Location (Axe)-18 [1], Jump Kick-19 [1], Kicking-20 [1], Knee Strike-22 [1] and Spin Kick-20 [1].

### Telepathy Skills

Illusion-22 [8], Mental Blow-19 [1], Mental Stab-23 [12], Mental Blast-28 [32], Mind Shield-28 [16], Mindwipe-22 [8], Suggest-25 [20], Telecontrol-25 [20], Telereceive-28 (Intergalactic Range) [40], Telescan-25 [10] and Telesend-35 (Intergalactic Range, Cannot Lie) [66].

## Story

Clarrissa, the human female penultimate, was thrown at Kimball by their Patrol superiors, and Mentor saw to it that they slipped into a “wide-open two-way” mind-link and fell in love. Kinnison made Clarrissa the only female Lensman ever and gave her partial Second-Stage training. Her discoveries on Lyrane II allowed Kimball to infiltrate and finally eliminate Boskone.

After the end of the Boskonian War, Mentor declared their marriage “necessary.” Their wedding was a major part of the Civilization-wide victory festivities and the most celebrated social event of all history.

The “Red Lensman” is universally adored. It is almost impossible for her to pay for anything. In one well-known example, after mustering out of the Patrol, she ordered her civilian trousseau from Brenleer’s of Thrale. Brenleer refused payment, requesting instead a simple signed statement that she had shopped there. The famous “Red Lensman’s Chit” is framed and displayed at the main Brenleer’s.

Some twenty years after the war, Clarrissa received complete Second-Stage training from her son, since Mentor’s inherent sexlessness so revolted her that she could not let him into her mind. She went again to Lyrane II, captured Black Lensman Cleonie and learned much of the Spawn of Boskone’s conspiracies. Clarrissa faced her bitterest trial when she let go, to what she knew to be certain death, the man millions of years of preparation had made her to love, without even thinking anything that would weaken his resolve.

After Kim entered the Hell-Hole in Space, Mentor, even aided by the Children of the Lens, could not locate him, and Mentor believed him slain. Clarrissa, however, knew for a certainty that he lived. She began her own search, at first alone, then joined in fusion against Mentor’s direct orders by her children. Her unparalleled vital drive found her beloved husband, and Mentor arranged his return.

## Quotes

“He’s worse than a baby. I never saw such a . . . such a *brat* in my life. I’d like to spank him — he needs it. I’d like to know how *he* ever got to be a Lensman, the big cantankerous clunker! I’m *going* to spank him, too, one of these days, see if I don’t!”

“On the beam and on the green, Gray Lensman, all the way. Every long, last millimeter. There, wherever it is — to the very end of whatever road it has to be — and back again. Until it’s over. I’ll be here. Or somewhere, Kim. Waiting.”

## NADRECK

*Second-Stage Lensman, Unattached. Z-Worlds Minister.*  
Exalted Palainian third-sex. 3,268 points.

ST 17 [150] IQ 21 [125] DX 18 [150] HT 21 [200]  
Speed: 9.75 Move: 9 Dodge: 9

## Advantages

Alertness-5 [25]; Allies (Kimball [415], Tregonsee [335] and Worsel [360] all fairly often); Charisma-5 [25]; Combat Reflexes [15]; Compartmentalized Mind-5 [250]; Danger Sense [15]; Eidetic Memory [30]; High Pain Threshold [10]; Intuition [15]; Lensman [100]; Longevity [5]; Luck [15]; Military Rank-9 (Unattached) [45]; No Cowardice [10]; No Weak Will-2 [16]; Palainian 17; Patron (Karen Kinnison, fairly often) [120];

Patron (Mentor, rarely) [40]; Rapid Healing [5]; Reputation-4 (all Civilization all the time) [20]; Sense of Perception [100]; Status-6 (Second Stage Lensman) [30]; Strong Will-4 [16] and Telepathy-33 [115].

## Disadvantages

Code of Honor (Gray Seal) [-15]; Enemy (Boskonian, all the time) [-120]; Extremely Hazardous Duty (Galactic Patrol) [-20]; Fanaticism (Civilization) [-15]; Honesty [-10]; Sense of Duty (Civilization) [-20].

## Quirks

Analytical; devious and subtle; obsessed by his “failure” at Onlo, specifically by Kandron; perfectionist; verbosely self-deprecating.

## Skills

Acting-21 [1], Administration-21 [1], Armoury-21 [1], Astrogation-21 [1], Battlesuit-21 [1], Camouflage-22 [1], Electronics-21 [2], Electronics Ops-21 [1], Engineer (Electronics)-20 [1], Escape-22 [32], First Aid-22 [1], Free Fall-23 [32], Gunner-23 [32], Intelligence Analysis-21 [2], Inertialess Agility-20 [16], Interrogation-22 [2], Jeweler-20 [1], Mechanic-21 [1], Philosophy-20 [1], Piloting (speedster, inert)-23 [40], Piloting (speedster, “free”)-23 [40], Psionics-26 [14], Psychology-28 [9], Shadowing-21 [1], Stealth-23 [32], Tactics (space combat)-20 [1], Traps-22 [2], Vacc Suit-26 [6] and Xenology-20 [1].

## Telepathy Skills

Illusion-28 [36], Mental Blow-25 [24], Mental Stab-25 [24], Mental Blast-25 [24], Mind Shield-35 [32], Mindwipe-35 [64], Suggest-30 [44], Telecontrol-30 [44], Telereceive-35 (Intergalactic Range) [70], Telescan-28 [14] and Telesend-26 (Intergalactic Range, Cannot Lie) [22].

## Story

It is obvious in retrospect that Nadreck, the Palainian third-sex penultimate, was insane — he accepted avoidable danger. His afflictions should have excluded him from nearly every aspect of Palainian society, but he used his intuitive and brilliant psychological understanding to conceal his own psychoses. His recklessness led him to become a Combat Psychologist in the Palainian Sentinals. While seeking assistance on a project, he met Tallick, the Palainian First Lensman, who convinced him that a Lens would not only make his current project possible, but also might help control his pathologies. Mentor in turn persuaded him to work with the Galactic Patrol and gave him Second-Stage training immediately, making Nadreck the third Second-Stage Lensman and the only one to skip First Stage altogether.

Nadreck’s operations against Boskone, such as the affairs of Shingvors and Antigan, were numerous, efficient and efficacious, and greatly confused their profile of the fictitious single Lensman “Star A Star.” While spying on the Eich of Lyrane VIII, Nadreck learned of his opposite number in Boskone, the psychologist Kandron, whom he later located on Onlo. However, Kandron was absent while Nadreck reduced that fortress world, and the two nemeses eluded each other’s deathtraps for many years thereafter.



### Disadvantages

Code of Honor (Gray Seal) [-15]; Enemy (Boskonian, all the time) [-120]; Extremely Hazardous Duty (Galactic Patrol) [-20]; Fanaticism (Civilization) [-15]; Honesty [-10]; Overconfidence [-10]; Sense of Duty (Civilization) [-20].

### Quirks

Absently braids tentacle-tips together when lost in thought; amiable; revolted by violence; tends to adopt the speech patterns of his companions; wishes to understand color and sound.

### Skills

Administration-21 [1], Astrogation-21 [1], Beam Weapons (DeLameter)-20 [1], Criminology-21 [1], Diplomacy-21 [1], Electronics Ops-21 [1], Free Fall-19 [1], Gunner-19 [1], Inertialess Agility-20 [4], Law-18 [18], Leadership-21 [1], Mathematics-22 [3], Philosophy-24 [5], Physiology-19 [1], Piloting (speedster, inert)-23 [24], Piloting (speedster, "free")-23 [24], Psionics-23 [8], Space-Axe-19 [1], Strategy (space combat)-25 [6], Tactics (space combat)-27 [8] and Vacc Suit-21 [1].

### Quotes

"I practically failed. It is the poorest piece of work of which I have been guilty since cubhood, and I desire and I insist that it shall not be mentioned again. If you wish to lay plans for the future, I will be very glad indeed to place at your disposal my small ability — which has now been shown to be even smaller than I had supposed — but if you insist upon discussing my fiasco, I shall forthwith go home."

## TREGONSEE

*Second-Stage Lensman, Unattached. Senior Director, Inculcation Command. Exalted Rigellian male; 7'2", 387 lbs.; reddish-brown hide, tentacles shading to yellow at tips. 3,328 points.*

ST 53 [150]    IQ 21 [200]    DX 20 [175]    HT 21 [200]  
Speed: 12.25    Move: 10    Dodge: 10

### Advantages

Alertness-5 [25]; Allies (Kimball [415], Nadreck [325] and Worsel [360] all fairly often); Charisma-5 [25]; Combat Reflexes [15]; Compartmentalized Mind-4 [200]; Eidetic Memory [30]; High Pain Threshold [10]; Intuition [15]; Lensman [100]; Longevity [5]; Military Rank-9 (Unattached) [45]; Not Hidebound [5]; Not Obdurate [10]; No Weak Will-4 [32]; Patron (Camilla Kinnison, fairly often) [120]; Patron (Mentor, rarely) [40]; Rapid Healing [5]; Reputation-4 (all Civilization all the time) [20]; Rigellian [453]; Status-6 (Second Stage Lensman) [30]; Strong Will-3 [12] and Telepathy-32 [135].

### Telepathy Skills

Illusion-25 [24], Mental Blow-22 [12], Mental Stab-22 [12], Mental Blast-22 [12], Mind Shield-30 [22], Mindwipe-25 [24], Suggest-22 [12], Telecontrol-22 [12], Telereceive-2 (Intergalactic Range) [45], Telescan-35 [28] and Telesend-28 (Intergalactic Range, Cannot Lie) [31].

### Story

That Tregonsee, a Rigellian penultimate, would chose to be male and apply to the Rigellian campus of the Galactic Patrol's Academy was unquestioned from his early youth. A restless, discontented child, he was fascinated by the stories of those other youths which wasted "so much time, effort, and wealth upon a project so completely useless as exploration." After graduation, Tregonsee was given command of the Patrol base on Trencu. Kinnison encountered him there and gave him an abbreviated version of Second-Stage training. Soon after, he went to Arisia for the full treatment.

He transferred into Grand Fleet Operations where his sense of perception and shrewd grasp of space-fleet tactics proved invaluable, and then into the Inculcation Command. It was in that work that he found his metier, and he was made Director of the Thrale Annexation.

### Quotes

"I have encountered Tellurians here, of course, but they were not of a type to be received as guests."

"I have wished for sight and hearing, those two remarkable and entirely unexplainable senses. I have dreamed, I have studied volumes, on color and sound."

# WORSEL

*Second-Stage Lensman, Unattached. Galactic Coordinator, First Galaxy.* Exalted Velantian male; 31' 8½" long; 1,623 lbs.; greenish-brown scales, copper eyes. 3,625½ points.

ST 30 [175] IQ 22 [225] DX 20 [175] HT 21 [200]  
Speed: 11.25 Move: 33 Dodge: 11

## Advantages

Alertness-5 [25]; Allies (Kimball [415], Nadreck [325] and Tregonsee [335] all fairly often); Charisma-5 [25]; Combat Reflexes [15]; Compartmentalized Mind-6 [300]; Eidetic Memory [30]; Intuition [15]; Lensman [100]; Longevity [5]; Luck [15]; Military Rank-9 (Unattached) [45]; No Weak Will-6 [48]; Patron (Constance Kinnison, fairly often) [120]; Patron (Mentor, rarely) [40]; Rapid Healing [5]; Reputation-4 (all Civilization all the time) [20]; Sense of Perception [100]; Status-6 (Second Stage Lensman) [30]; Strong Will-2 [8]; Telepathy-34 [95] and Velantian [479].

## Disadvantages

Code of Honor (Gray Seal) [-15]; Bloodlust [-10]; Enemy (Boskonian, all the time) [-120]; Extremely Hazardous Duty (Galactic Patrol; Fanaticism (Civilization) [-15]; Honesty [-10]; Impulsiveness [-10]; Intolerance (Delgonians) [-10]; Overconfidence [-10]; Sense of Duty (Civilization) [-20].

## Quirks

Always writhing, never still; enjoys studying hallucinations; flamboyant; loves hand-to-hand combat; performs aerobatics whenever flying.

## Skills

Acrobatics-23 [24], Administration-22 [1], Astrogation-22 [1], Beam Weapons (DeLameter)-22 [4], Carousing-20 [1], First Aid-23 [1], Flight-22 [8], Free Fall-23 [16], Gunner-19 [1], Inertialess Agility-20 [4], Interrogation-22 [1], Karate-18 [1], Leadership-22 [1], Mathematics-21 [1], Performance-24 [3], Piloting (speedster, inert)-23 [24], Piloting (speedster, "free")-23 [24], Psionics-20 [1], Psychology-26 [6], Strategy (space combat)-20 [1], Tactics (space combat)-23 [3] and Vacc Suit-22 [1].

## Tsudu Maneuvers

Aggressive Parry-12 [6], "Corkscrew" (see p. 116) [4], Flying Head Butt-18 [1] and Wing Baffling-22 [1].

## Telepathy Skills

Illusion-35 [60], Mental Blow-30 [40], Mental Stab-30 [40], Mental Blast-30 [40], Mind Shield-22 [4], Mindwipe-30 [40], Suggest-28 [32],

Telecontrol-28 [32], Telereceive-25 (Intergalactic Range) [15], Telescan-30 [16] and Telesend-23 (Intergalactic Range, Cannot Lie) [4½].

## Story

A warrior-scientist and male Velantian penultimate, Worsel was stealthily probing the Overlords in their lairs when Kinnison and vanBuskirk landed on Delgon. Their undisciplined thoughts threatened to attract the monsters, and Worsel was forced to rescue them or be captured himself. Realizing instantly that the more advanced technology of the aliens could be the advantage necessary to end the subjugation of his race, he took them to the Council of Scientists on Velan. With their aid, Kinnison captured a Boskonian warship and left for Tellus. Worsel went to Arisia for a Lens while the Council prepared a massive and thorough campaign of genocide.

Returning with his Lens, Worsel led the lightning attacks on the labyrinthine caverns of the Overlords, and soon that race was reduced to small enclaves scattered throughout the galaxy. Worsel then brought Velan into the Galactic Union, where he became one of the "High-Tension Thinkers" noted for mental prowess and stability.

After the fall of Thrale and Onlo, Worsel became the Galactic Coordinator for the First Galaxy.

## Quotes

"I never could understand why you soft-headed, soft-hearted, soft-bodied human beings are so reluctant to kill your enemies. What good does it do merely to stun them?"

"I could use this — or this — or this. I am not going to, however — yet. While you are still sane I shall take your total knowledge."

"I have been thinking. I have been thinking about thought."



# GAZETTEER

## CHAPTER FOUR



## ◎ CLEAR ETHER

The spaceman's standard wish to the contrary, the interstellar medium is anything but clear, and traveling through it can get altogether too exciting even without Boskonian pirates.

Let us take a journey on a space-liner, from Klovia in the Second Galaxy to Centralia in the heart of the First. It is a fast ship, so we have swung a little below the Galactic plane, to avoid the worst of the hampering dust. The ship is now passing, in the distance, some of the Galaxy's satellites, the globular clusters. Each of these hundred or so bright yellow-orange points of light contains about a million ancient stars. We can also see a few faint individual stars, loners in the vast night, as we pass nearby. We have just entered the galactic halo, some 30,000 parsecs from Centralia in the Galaxy's core.

The view is breathtaking. The passengers can see the Milky Way arching a third of the way across the dome of the observation deck, its vast sweep softly illuminating the darkened deck's shadows with the diffuse glow of several hundred thousand million suns. It seems to be a huge luminous disk of stars, interlaced with ribbons of dark dust outlining spiral arms, all smoothly pin-wheeling around a bright central bar.

The ship's pilot, though, alert at his controls, sees that orderliness as it is: an illusion, hiding a tangled and violent reality. Already he is correcting for the million degree, hurricane-force plasma wind that orbits within the Galaxy's magnetic field and is trying to carry the ship along with it. His instruments see the enormous, slowly wavering filaments and loops of gas that arch out of the Milky Way's disk and into the halo we are speeding through. He is glad we are entering just off the Galaxy's equator — the poles of the Galaxy emit a focused jets of plasma at unimaginable velocities.

We will be passing near to one of the globular clusters, close enough to make out individual stars. The captain slows the ship to a stately hundred parsecs per hour, giving us over half an hour to gaze into this jewel. More than a million stars are collected in this cluster, with over 200 stars crowded into each cubic parsec. These deep orange-yellow stars are all ancient, formed at the same time as the galaxies themselves. The pilot relaxes slightly. The dust and gas is thin here; it was long since blown away by the stellar winds of these stars.

The journey continues and we see ahead a fiery glow. A host of hot young stars lies embedded in the gas and dust, each emitting prodigious amounts of actinic ultra-violet and X-radiation. Here stars are condensing out of the abundant interstellar gas, bursting out of dusty cocoons as the nuclear furnaces in their cores ignite. We cannot get a close look — our pilot is veering wide of this maelstrom!

We begin to enter one of the Galaxy's arms, which trail from each end of the central bar and branch into several sub-arms. The ship begins lurching, although the passengers can't feel it, protected by the pseudo-inertia generators. Hot stellar winds buffet the ship, reaching speeds of up to 2,200 miles per second, their fierce howling drowning out not only the electros, but the very ultra-wave as well. Stars punch through gas and dust clouds at hundreds of miles per second, forming comet-like shock-waves that rock passing space-ships exactly like atmospheric "sonic booms."

The ether is far from clear here. Our Galaxy is as full of bubbles as a freshly-opened bottle of fayalin. Stellar winds, carrying hundreds of thousands of millions of tons of plasma, push the surrounding gas and dust parsecs away, forming shells of dense matter around regions of thinner stuff. When these empty regions combine or are otherwise particularly large, astrographers refer to them as "rifts." Many are blank spots on the charts. The galaxies are huge, and commercial shipping seeks the fastest and cheapest routes. Punching through the dense shells surrounding rifts slows a ship down and the dust and gas erodes the ship's hull, adding to the maintenance costs.

But not all bubbles are neat and predictable. As the stars move, they blast through each others' shells, creating chaotic turbulence. A sharp mind and a deft hand are required at the pilot's console. Not only must he keep the inertialess ship from plummeting into every nearby star, snatched off-course by its gravitational pull, but he must also anticipate the under-tows and vortices of the interstellar currents.

As we near the core bar of the Galaxy the temperature rises sharply. Within 300 parsecs of our destination it has reached nearly a hundred million degrees! Here, space itself is hotter than the center of Sol or Klovia's sun. Our screens can handle the temperature as well as the heavy X-ray dose rate, but our speed has been reduced to a thirtieth of what it was at the Galaxy's edge and a thousandth of our speed between the galaxies.

As we draw near Centralia, our destination, the pilot's work increases tremendously. Centralia is barely thirty parsecs from the center of the Milky Way, and the incredibly dense interstellar gas surrounding it is unimaginably turbulent. This region teems with supernovae, and the galactic magnetic field is strong enough to noticeably disturb our course. This region is the origin of the arc-like filaments, hundreds of parsecs long, that rear up from the plane of the Galaxy like prominences from a star.

Centralia is the end of our trip. We cannot enter the Galaxy's core — our shields would be quickly overwhelmed by the inconceivable energies at play in the central ten parsecs of our Galaxy. Two sources produce these energies: the countless stellar clusters with over a million blue super-giant stars in a single cubic parsec — so dense that tidal disruptions and even collisions and mergers between individual stars are common . . . and the mysterious, unfathomable Sagittarius A\*.



A highly turbulent circum-nuclear disk of gas extends some seven parsecs from the center of the Galaxy. Within the disk is a cavity two parsecs in radius where the gas is only a tenth as dense as its surroundings and is striated into spiral arms like a miniature galaxy. At the centroid of the spiral sits . . . an enigma.

Sagittarius A\* is very small; certainly it would fit within the orbit of Jupiter (Sol V) and some theories suggest that it is about the size of the orbit of Mercury (Sol I). It appears to mass some two or three million Solar masses. Its temperature cannot be measured save indirectly, but those observations seem to indicate that its surface is at least ten million degrees. It is radiating well over a hundred million million *tons* of energy every second. Even the shields of a super-dreadnought would be instantaneously obliterated by such energies.

Although Sagittarius A\* remains a conundrum for the present, research continues. Not only does it inspire intense scientific curiosity, but the Galactic Patrol is also investigating the possibility of setting up a network of installations around it to power a sunbeam — a galaxibeam? — for galactic defense.

But we're stopping at Centralia. We'll arrive at the spaceport in mid-morning. You'll have plenty of time to check in to one of the many fine hotels in the area, so be sure to take an evening walk in the parks around the port — don't forget the star-tan oil! — and watch the stars come out. By the myriads of millions.

## Ether Density

The rated cruising and maximum speeds of a spaceship calculated at construction are based on the density of interstellar gas (the so-called "ether density") around Sol — about one atom per cubic centimeter. The ether density is not, however, constant. Depending on the location in or out of the Galaxy, it varies wildly, and speed varies with it. As a spaceship travels, multiply its rated speed by the factors in the table below.

Extra-galactic .....	30
Galactic Halo .....	10
Galactic Rift .....	5
Galactic Arm, Outer Edge .....	2
Galactic Arm, Inner Edge .....	1
Nebulae .....	0.03
Galactic Core .....	Impassable

GMs should vary these numbers by up to a full order of magnitude at will — dust pockets and rifts are common and unpredictable.

Within the arms of the galaxies, where the ether density is moderate, warships of the Galactic Patrol cruise at sixty parsecs an hour, and can sprint at ninety pph. At these speeds, individual stars whip by at about one per minute and it takes a day and a half to cross a galactic arm. Outside the galactic arms, where the dust thins out, higher speeds are possible. Ships traveling long distances frequently drive out of the galaxy as directly as possible, then blast at high speed through the galactic halo, and only drop back into the galaxy near their destination. Using this detour, the Centralia-to-Vandemar run (galactic core to rim) takes a week.



## Loose Atomic Vortices

The conditions obtaining within the interior of a breeding atomic power pile — summed up by the infamous "reactor kinetics equations" — are starkly impossible of comprehension to entities of the first level of stability or less. The nucleonicists that can truly grasp them are a rare and special breed, for an atomic pile comprises conditions that do not exist anywhere else in the macrocosmic universe. Even the interiors of stars never resemble the breeding cycle of a power pile.

The vortex created within a pile is not self-sustaining . . . under nearly all conditions. Unfortunately, the conditions under which one *can* become self-sustaining are impossible to predict, and have occurred several times in the past centuries, on Tellus as well as other planets. The results are catastrophic and permanent. They never go out. Every living thing near a flare-up dies, either from the 25,000° shock wave or from the 30,000-rad blast of radiation. Every solid thing within a radius of hundreds of feet melts down into the reeking, boiling slag of its crater. They create a permanently raging storm, as they suck in surrounding air and fountain it upward, heated to thousands of degrees, a trivial effect compared to the others. For as the air enters the vortex, it is transmuted, randomly. The composition of the super-heated effluent gasses varies as wildly as any other feature of the vortex. It may be poisonous, or corrosive or simply different, but it is no longer air breathable by humans.

## Sources of Atomic Vortices

For many centuries, the cause of atomic vortices was unknown. The College of Radiation developed several theories, but were understandably reluctant to test them until a sure method of extinguishing a successful test was demonstrated. Terrorists touched off a handful of loose vortices, but the true cause was eventually discovered to be a fantastically alien form of life based on pure, self-organizing energy, which mated inside atomic piles, driving them out of control. The resulting vortices were the incubator-wombs of their offspring. These Cahuitans were unaware of the existence of physical life. When they learned of the damage they were causing, they readily agreed to confine their sexual activities to barren worlds pointed out to them by the Galactic Patrol.

Creating a loose vortex by physical means requires bombardment of an atomic power plant with a beam of fast neutrons ultra-heterodyned with subetheric zeta-rays from a range of about a hundred yards. (Whether this range is within the total destruction radius of the flare-up is difficult to calculate. *Caveat* terrorist.) The projector for such a beam is the size of a semi-portable, and involves highly secret technology. It need only be directed at the atomic pile for a few seconds for that pile to enthusiastically flare out of control.

## Extinguishing Atomic Vortices

Vortices can be moved, with difficulty, since they are affected by pressors (though not by tractors). Various schemes for disposing of them have been proposed, such as enclosing them in a Bergenholm's field and throwing them into deep space. None of them proved to be practical, and many proved fatal. The only successful method is to "blow it out."

At any given moment, a precisely metered explosive charge (on the close order of twenty pounds of duodecaplylatomate), precisely placed, will extinguish — "blow out" — an atomic vortex. However, the precise amount and precise location continually change in an entirely chaotic manner. It is possible to forecast a vortex's flux by an extension of the calculus of warped surfaces, but for many years, the fastest automatic computers could not complete such a calculation in less time than the calculation was good for. An incorrect charge may do nothing . . . or it may, with equal probability, scatter the vortex.

If a vortex is successfully "blown out," the fantastic violence of several dozen pounds of duodec is joined and dwarfed by the entire energy of the vortex. The result is a multi-megaton atomic explosion.

## Other Tellus-Type Planets

There are several thousand million Tellus-type (T-T) planets in each galaxy. Some examples include:

Alsakan (1G) — located diametrically opposite Tellus in the Milky Way. Its tobacco crop is famous throughout Civilization, and Alskanite cigarettes command premium prices everywhere.

Boyssia II (1G) — a primitive planet inhabited by savage native life, some of which are cave-or cliff-dwellers, but most are nomadic. It was the site of a very strong Boskonian base, which was destroyed by the mutinous Blakeslee.

Bronseca (1G) — Cominoche, its capital city, was almost totally obliterated in an urban battle involving ground bombardment by maulers of space.

Centralia (1G) — the T-T planet nearest the core of the Milky Way, and the source of nitrolabe.

Chickladoria (1G) — a very warm planet, whose scantily-clad natives have remarkable reflex reaction times.

Corvina II (1G) — origin of the spaceman's deity Klono and the drug bentlam.

Euphrosyne (1G) — not a planet, but a giant asteroid in the Borovan system. It is owned in toto by Miner's Rest, GmbH, maintained at T-T conditions and operated as a complex of trading posts, boarding houses, dance halls, gambling hells, bars and drug dens for the meteor miners of the asteroid belt of the Borovan system.

Kalonia III (2G) — Kalonians are human to the limits of classification excepting only their skin hue — an intense shade of indigo reminiscent of the deadly Cherenkov radiation given off by supra-luminal delta-rays. Their society is tyrannically patriarchal, subjugating their females to mere child-bearing.

Manarka (1G) — Manarkans are very thin humans who developed telepathy so extensively that they have lost both speech and hearing. Their society values modesty and requires heavy clothing. Both Manarkan jewelry and fabric are highly valued throughout the galaxies, particularly stardrops and glam-orette, respectively.

Medon (½G) — one of the last planets remaining free of Boskone in the Second Galaxy, and the first to be contacted by Civilization. Home of a highly advanced society (particularly in electronics), which invented the super-conductors and -insulators that gave Civilization its much-needed technological edge over Boskonian, making possible both the rapid-firing primary beam and the "free" planet. They used a planetary Bergenholm system to flee Boskone.

Posenia (1G) — a Tellus-type planet in all respects except that chlorine is found where oxygen is usual on Tellus. Its atmosphere is a mixture of nitrogen and chlorine, and its oceans are hydrochloric acid. Most Posenian animal life has the sense of perception.

Radelix (1G) — a planet about a hundred parsecs from Boysia, with a large Patrol base, but nonetheless very thoroughly infested with the zwilnik trade. Its capital, Ardith, was home of Bominger's saloon and Nalizok's Cafe, both notable drug-houses. A native animal, the *oglon*, or "cateagle," has become a symbol of vicious ferocity.

Thrale (Thrallis II) (2G) — a hospitable planet with four moons and center of the T-T side of the Thrale-Onlonian Empire.

Tominga (1G) — a high-gravity Tellurian planet noted for its horticulture.

Tressilia III (1G) — former location of the Crown-on-Shield, not only one of the most expensive and exclusive gilded palaces of decadent sin in all of Civilization but also a major Boskonian front for drug trafficking.

Vandemar (1G) — the T-T planet farthest from the core of the Milky Way, but still within the Milky Way itself. Situated directly in line with the galaxy's bar, it is the endpoint of the arbitrary navigation baseline of the First Galaxy. It is also the prime source of hadive.



## Radeligian Oglons — "Cateagles"

ST: 18	Move/Dodge: 18/9#	Size: 2
DX: 13	PD/DR: 2/1	Weight: 40-55 lbs.
IQ: 3	Damage: 1d cut	Origin: Radelix
HT: 13-16	Reach: C	Habitats: M, P

Oglons are winged mammals with a fantastically blood-thirsty temper. Oglons will attack anything, anywhere, anytime, except for each other — that only happens *most* of the time . . . They attack in close combat, biting and clawing. Their vision may include some of the infra-red, as they seek out major blood-vessels by preference. Thus, on humans, their attack is usually to the neck.

Oglons fly at a Move of 18, run on the ground at 7.



# PLANETS

## Aldebaran ( $\alpha$ Tauri) I

### First Galaxy

Planet Type: Desert/Hot; Diameter: 5,644 miles; Gravity: 0.90G; Density: 7.2; Composition: Metallic; Axial Tilt: 3°; Seasonal Variation: None; Length of Day: 765 days; Length of Year: 510 days.

Atmospheric Pressure: None; Climate: Very Hot; Temperatures at 30° latitude: Low 120°F, Average 200°F, High 300°F; Surface Water: 0%; Humidity: 0%; Primary Terrain: Volcanic.

Little is known about the so-called Wheelmen of Aldebaran I. Those rolling beings, with sensory organs and manipulative tentacles at their hubs, were not, in fact, of Aldebaran I — that planet was simply an advance base for Boskone, convenient for the surveillance of Tellus and Sol system and supporting no native life. When that base was obliterated, so was all trace of the race of Wheelmen.

## Aldebaran ( $\alpha$ Tauri) II

### First Galaxy

Planet Type: Tellus-like; Diameter: 7,306 miles; Gravity: 0.87G; Density: 5.2; Composition: Medium-iron; Axial Tilt: 9°; Seasonal Variation: None; Length of Day: 26.3 hours; Length of Year: 1,997 days. Two giant moons: Siva and Parvati.

Atmospheric Pressure: Standard; Composition: Oxygen-nitrogen; Climate: Tropical; Temperatures at 30° latitude: Low 90°F, Average 100°F, High 110°F; Surface Water: 88%; Humidity: 55%; Primary Terrain: Forest/Jungle.

Aldebaran II is an Edenic planet, and has become one of the most popular sites of tourism in the Milky Way. It is frequently compared with the Tellurian island of Tahiti, with Tahiti suffering in the comparison. The natives are human to the limits of analysis, and have created the only actual, working, utopian anarchy in either galaxy (possibly excepting Arisia itself). That society was largely abolished by Civilization's arrival, which

required representatives to speak for the planet, but many of its customs and lack of inhibitions remain. Perhaps the most noticeable remnant of innocence is the importance of sexual skill and experience in Aldebaran religion. Aldebaranians are justly famous (or notorious, depending on one's upbringing) as the best lovers wherever situated. All Aldebaranians' Erotic Arts skill defaults to IQ.

## Arisia

### First Galaxy

Planet Type: Tellus-like; Diameter: 7,860 miles; Gravity: 0.99G; Density: 5.5; Composition: Medium-iron; Axial Tilt: 24°; Seasonal Variation: Tellus-like; Length of Day: 23.6 hours; Length of Year: 423 days. One giant moon.

Atmospheric Pressure: Standard; Composition: Oxygen-nitrogen; Climate: Tellus-like; Temperatures at 30° latitude: Low 50°F, Average 70°F, High 90°F; Surface Water: 63%; Humidity: 44%; Primary Terrain: Hilly/Rough.

Arisia is an ancient planet. Its life-spores were the origin of nearly all other life in both galaxies. It had very few of the heavy elements when it was formed, and has no natural ones remaining at all now. However, any that are necessary are trivial to synthesize. The planet teems with many species of plants and animals, many of which are artificial. The race of Arisians, together with some of the more advanced animal life of their planet, evolved beyond the need for physical bodies long before humanity learned to use tools. After the destruction of Ploor and the cleanup of the Spawn of Boskone, they voluntarily passed beyond this plane of existence. Their planet is now uninhabited, although the new Guardians of Civilization, the Children of the Lens, are frequently there, researching their predecessors.

## Bennett

### First Galaxy

Planet Type: Tellus-like; Diameter: 7,324 miles; Gravity: 1.16G; Density: 6.9; Composition: High-iron; Axial Tilt: 29°; Seasonal Variation: Tellus-like; Length of Day: 41 hours; Length of Year: 194 days. Two large moons.

Atmospheric Pressure: Standard; Composition: Polluted Oxygen-nitrogen; Climate: Tellus-like; Temperatures at 30° latitude: Low 60°F, Average 80°F, High 100°F; Surface Water: 76%; Humidity: 62%; Primary Terrain: Rough.

Located in the Perseus arm just outside the solar system, Bennett became the Galactic Patrol's major shipyard and home port for the teardrop warships of the first Grand Fleet. Never having encountered Boskonia, the natives of Bennett were easily educated by the psychologists of the Patrol, and fully supported the incorporation of their planet as the industrial center of the early Galactic Union.



## Cavenda

### First Galaxy

Planet Type: Tellus-like; Diameter: 9,675 miles; Gravity: 1.13G; Density: 5.1; Composition: Medium-iron; Axial Tilt: 21°; Seasonal Variation: Tellus-like; Length of Day: 31.8 hours; Length of Year: 442 days. One small moon.

Atmospheric Pressure: Standard; Composition: Oxygen-nitrogen; Climate: Tellus-like; Temperatures at 30° latitude: Low 50°F, Average 80°F, High 110°F; Surface Water: 41%; Humidity: 22%; Primary Terrain: Prairie/Steppes.

The original culture of the primitive natives of Cavenda was similar to that of many of the aboriginal peoples of Tellus. Unfortunately for them, like many of their Tellurian counterparts, they were easily addicted to alcohol, and thus were easy prey for the Boskonian zwilniks who made their planet a way-point in the galactic thionite distribution system.

## Delgon (Velantia II)

### First Galaxy

Planet Type: Tellus-like; Diameter: 8,120 miles; Gravity: 1.1G; Density: 5.9; Composition: Medium-iron; Axial Tilt: 21°; Seasonal Variation: Tellus-like; Length of Day: 27.2 hours; Length of Year: 183 days. One medium-sized moon.

Atmospheric Pressure: Standard; Composition: Oxygen-nitrogen; Climate: Warm; Temperatures at 30° latitude: Low 70°F, Average 90°F, High 110°F; Surface Water: 54%; Humidity: 43%; Primary Terrain: Forest/Plains.

The native life of the home planet of the Overlords includes no mammalian species at all, a fact that puzzles many xenologists who do not believe that the Overlords could have driven them *all* into extinction. It does hold many other life-forms of generally insectile or reptilian nature, such as the hostile Catlats and a race biologically very similar to Velantians, but which continued predations by the Overlords have rendered completely mindless.

## Eddore

### Second Galaxy

Planet Type: Unique; Diameter: 32,767 miles; Gravity: 9.66G; Density: 12.87; Composition: Unique; Axial Tilt: 0°; Seasonal Variation: None; Length of Day: N/A; Length of Year: N/A.

Atmospheric Pressure: Super-dense; Composition: Corrosive; Climate: Very Hot; Temperatures at 30° latitude: Low 100°F, Average 110°F, High 120°F; Surface Water: 3%; Humidity: 83%; Primary Terrain: Pavement.

Eddore, having originated in a horribly alien different space, obeys none of the standard planetological laws. The Eddorians themselves rendered extinct nearly all other life on their planet eons before they began moving it from universe to universe, and completely exhausted their planet's resources soon after that. Synthesis of any required resource, though, is trivially cheap. The remaining dominant life-form was the All-Highest; other significant life-forms included the Innermost Circle. Lesser beings served, or were extinct.

Eddore was stationed within a star cluster in the Second Galaxy, but was not attached to any particular star, having long since been made independent of such unreliable features of nature.

The removal of the "evil effluvium" during the mop-up of the Spawn of Boskone exterminated all remaining life on Eddore, but the planet itself remains.

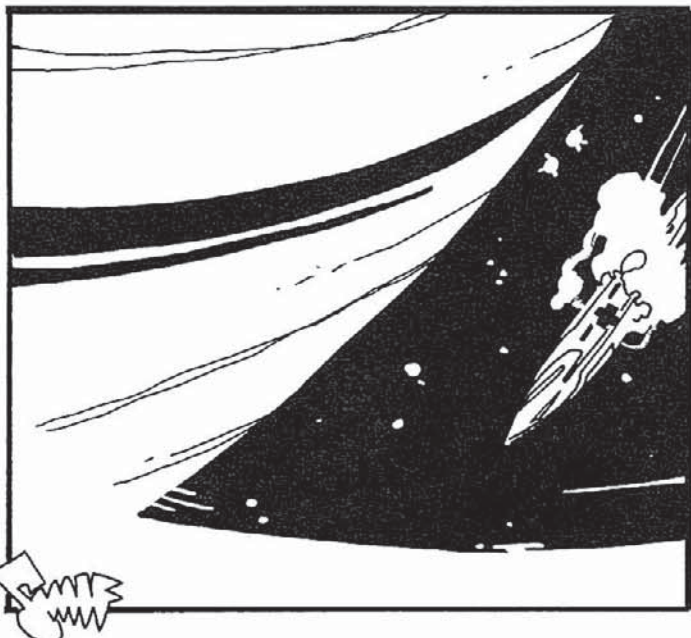

## Jarnevon

### Second Galaxy

Planet Type: Medium Gas Giant; Diameter: 65,502 miles; Gravity: 1.2G; Density: 0.8; Composition: Gas Giant; Axial Tilt: 2°; Seasonal Variation: None; Length of Day: Tidally locked; Length of Year: 4,650 days. 5 giant moons, 7 large, many small moons and moonlets, full rings.

Atmospheric Pressure: Thin near day pole, none near night pole; Composition: Methane-ammonia; Climate: Wide-ranging; Temperatures at 30° latitude: Low -455°F, Average -255°F, High -50°F; Surface Ammonia: 40%; Ammonia Humidity: 0-73%; Primary Terrain: Ammonia Swamp/Tundra.

The home planet of the Eich is tidally locked to its sun; the Eich dwell on the perpetually dark side. Its climate varies tremendously, from the volcanic day-side where poison geysers spew toxic gases, through the twilight region of hurricane-force winds blowing into the frigid dark, to the eternal empty calm of the Night Pole, where all atmosphere has frozen out and the Nine of Boskone make their headquarters.

## Jupiter (Sol V)

### First Galaxy

Planet Type: Large Gas Giant; Diameter: 86,709 miles; Gravity: 2.65G; Density: 1.3; Composition: Gas Giant; Axial Tilt: 3.1°; Seasonal Variation: None; Length of Day: 9.84 hours; Length of Year: 4,329 days. 4 large moons, many moonlets (number varies), thin faint rings, occasional trapped comets.

Atmospheric Pressure: Super-dense; Composition: Oxygen-nitrogen; Climate: Frozen; Temperatures at 30° latitude: Low -60°F, Average -20°F, High 20°F; Surface Water: 0%; Humidity: 0%; Primary Terrain: Plains.

Jupiter's enormous magnetic field has created an intensely powerful radiation belt. All four of the Galilean moons orbit within a field of about 10,000 rads per hour, mostly beta radiation. The inhabitants of those moons are immune to radiation, though the Jovians themselves are not. This difference played an important part in the European wars, and again in the four Triplanetario-Jovian Wars.

The Jovian sub-system (Jupiter's moons and Trojan point asteroids) are also inhabited.

### ***Io (Jupiter I)***

Planet Type: Rock-ball; Diameter: 2,184 miles; Gravity: 0.18G; Density: 3.6; Composition: Low-Iron; Axial Tilt: 0°; Seasonal Variation: None; Length of Day: 42.5 hours; Length of Year: 42.5 hours (tidal lock to Jupiter).

Atmospheric Pressure: Very Thin; Composition: Polluted; Climate: Very Cold; Temperatures at 30° latitude: Low -20°F, Average 0°F, High 20°F; Surface Water: 0%; Humidity: 0%; Primary Terrain: Volcanic.

Io's jumbled terrain, marked by orange and yellow hues, is the result of sulfur-rich materials brought to the surface by volcanic activity. The frequent seismic quakes and eruptions are caused by the gravitational tug-of-war between Io, Jupiter and the other three Galilean moons. Io has no native intelligent life, but was colonized long ago by both Jovians and Europans — and was the site of bitter warfare for many centuries.

### ***Europa (Jupiter II)***

Planet Type: Rock-ball; Diameter: 1,878 miles; Gravity: 0.15G; Density: 3.5; Composition: Low-Iron; Axial Tilt: 0°; Seasonal Variation: None; Length of Day: 85.3 hours; Length of Year: 85.3 hours (tidal lock to Jupiter).

Atmospheric Pressure: Thin; Composition: Oxygen-nitrogen; Climate: Very Cold; Temperatures at 30° latitude: Low -30°F, Average -10°F, High 10°F; Surface Water: 90%; Humidity: 0%; Primary Terrain: Creviced Frozen Ocean.

Europa, approximately the same size as Luna, is the brightest of Jupiter's satellites. Its surface is mostly jagged tundra and frozen-over oceans. Its native life forms developed a wide array of adaptations to the icy environment including "ice-skates" or "skis" of bone and horn, or webbed "snow-shoes," depending on their favored terrain. The Europans, aided by a sky that made it clear that their world was but one among many, developed space flight very quickly, and soon found themselves locked in bitter warfare with the Jovians.

### ***Ganymede (Jupiter III)***

Planet Type: Rock-ball; Diameter: 3,162 miles; Gravity: 0.14G; Density: 1.9; Composition: Silicate; Axial Tilt: 0°; Seasonal Variation: None; Length of Day: 172.0 hours; Length of Year: 172.0 hours (tidal lock to Jupiter).

Atmospheric Pressure: Thin; Composition: Oxygen-nitrogen; Climate: Frozen; Temperatures at 30° latitude: Low -40°F, Average -20°F, High 0°F; Surface Water: 50%; Humidity: 0%; Primary Terrain: Tundra.

Ganymede is the largest satellite in the solar system — larger than Mercury or Pluto. Like Europa, it is a world of ice and rock. Unlike that sister world, the Ganymedeans did not develop space-flight on their own, but were intelligent enough to be useful pawns in the endless Jovian-Europan wars, once discovered.

### ***Callisto (Jupiter IV)***

Planet Type: Rock-ball; Diameter: 2,904 miles; Gravity: 0.12G; Density: 1.8; Composition: Silicate; Axial Tilt: 0°; Seasonal Variation: None; Length of Day: 402.1 hours; Length of Year: 402.1 hours (tidal lock to Jupiter).

Atmospheric Pressure: Very Thin; Composition: Oxygen-nitrogen; Climate: Frozen; Temperatures at 30° latitude: Low -50°F, Average -30°F, High -10°F; Surface Ice: 95%; Humidity: 0%; Primary Terrain: Cratered Tundra.

Callisto was once an inhabited world, with a thick atmosphere and oceans dotted with many islands. The Jovian-Europan wars included heavy fighting on and around Callisto, and Callisto's atmosphere was eventually stripped off by super-atomic carpet bombing. The oceans quickly froze as they boiled away, leaving the heavily cratered tundra that now makes up its dead surface.

### ***Klovia***

Planet Type: Tellus-like; Diameter: 7,642 miles; Gravity: 0.98G; Density: 5.6; Composition: Medium-iron; Axial Tilt: 28°; Seasonal Variation: Tellus-like; Length of Day: 26.32 hours; Length of Year: 326 days. One giant moon: Selene, one small moon: Diana.

Atmospheric Pressure: Standard; Composition: Oxygen-nitrogen; Climate: Tellus-like; Temperatures at 30° latitude: Low 50°F, Average 70°F, High 90°F; Surface Water: 82%; Humidity: 50%; Primary Terrain: Plains/Steppes.

Klovia, much like Bennett before it, was a balkanized, pre-TSO world that was completely untouched by Boskonian when the Patrol arrived. The psychologists found them ready subjects for incorporation into Civilization, and the entire planet became a stupendous military base — Ultra Prime, the center of Patrol operations in the Second Galaxy, and later, the headquarters of the Galactic Coordinator. The Guardians of Civilization have their home there, although they are more often on Arisia now that Mentor and his race have left that planet.

### ***Second Galaxy***



## Lonabar

### First Galaxy

Planet Type: Tellus-like; Diameter: 6,993 miles; Gravity: 1.02G; Density: 6.4; Composition: High-iron; Axial Tilt: 18°; Seasonal Variation: Tellus-like; Length of Day: 25.9 hours; Length of Year: 482 days. Three large moons: Corun, Cedony and Chrys.

Atmospheric Pressure: Standard; Composition: Oxygen-nitrogen; Climate: Tellus-like; Temperatures at 30° latitude: Low 60°F, Average 80°F, High 100°F; Surface Water: 83%; Humidity: 43%; Primary Terrain: Forest.

The center of Menjo Bleeko's Boskonian operations is a planet beyond Rift 85. Gems and other precious and semi-precious stones are very plentiful and fashionable everywhere. Export regulations are strict, to avoid flooding the gem markets, which of course makes smuggling a profitable enterprise.

Dancing is a highly valued art-form on Lonabar, and a spectacular one. It resembles Tellurian dancing only slightly — it is more similar to free-style gymnastics. All Lonabarian children receive dance training; all Lonabarian adults are DX +1 and have Dancing skill at DX.

## Lyrane II

### First Galaxy

Planet Type: Tellus-like; Diameter: 7,632 miles; Gravity: 0.96G; Density: 5.5; Composition: Medium-iron; Axial Tilt: 18°; Seasonal Variation: Mild; Length of Day: 25.89 hours; Length of Year: 312 days.

Atmospheric Pressure: Standard; Composition: Oxygen-nitrogen; Climate: Tropical; Temperatures at 30° latitude: Low 70°F, Average 95°F, High 120°F; Surface Water: 71%; Humidity: 55%; Primary Terrain: Prairie/Forest.

The persons of this almost-perfectly Tellurian planet in Dunstan's Region beyond Rift 94 were a key part of Boskone's operations in the Milky Way. The Lyransians were attractive as a proxy race to the asexual Eddorians because of their active research and experimentation toward complete elimination of the necessity of sex. One of the first Black Lensmen was a Lyransian person, Cleonie.

## Lyrane VIII

### First Galaxy

Planet Type: Icy Rock-ball; Diameter: 10,072 miles; Gravity: 1.08G; Density: 4.7; Composition: Medium-Iron; Axial Tilt: 9°; Seasonal Variation: Mild; Length of Day: 294 hours; Length of Year: 5,385 days.

Atmospheric Pressure: Thin; Composition: Helium-exotic; Climate: Palain-like; Temperatures at 30° latitude: Low -430°F, Average -400°F, High -370°F; Surface Water: 0%; Humidity: 0%; Primary Terrain: Hilly/Rough.

This dark and coldly poisonous planet formed one of the major links between the Second Galaxy and the First, and became the main Eich base after Jarnevon was destroyed. As such, it was extremely well defended, so it was bypassed rather than reduced. It was only after the fall of the Thralian-Onlonian Empire that Lyrane VIII was mopped up.

## Lyrane IX

### First Galaxy

Planet Type: Icy Rock-ball; Diameter: 4,562 miles; Gravity: 0.44G; Density: 4.2; Composition: Low-Iron; Axial Tilt: 111°; Seasonal Variation: Severe; Length of Day: 4,895 days; Length of Year: 9,645 days.

Atmospheric Pressure: Trace; Composition: Helium-Exotic; Climate: Cold; Temperatures at 30° latitude: Low -450°F, Average -430°F, High -410°F; Surface Water: 0%; Humidity: 0%; Primary Terrain: Rocky.

The Black Lensman received their Lenses from the Ploorans on this lifeless, barren world. They conducted their operations with such stealth that no evidence of their visits has ever found there, even by historical researchers working with considerably more care than the original combat units. It appears that this world was used solely because of its proximity to Lyrane II (which persons both produced more Black Lensman and were closer to the Eddorian ideal of sexlessness than their rival Proxies of Power, the Kalonians). However, some investigations continue, based on questionable interpretations of a few cryptic references in obscure Kalonian documents.



## Mars (Sol IV)

### First Galaxy

Planet Type: Desert; Diameter: 4,223 miles; Gravity: 0.38G; Density: 3.94; Composition: Low-iron; Axial Tilt: 24°; Seasonal Variation: Tellus-like; Length of Day: 24.62 hours; Length of Year: 687 days. Two moonlets: Deimos and Phobos.

Atmospheric Pressure: Thin; Composition: Oxygen-nitrogen; Climate: Very Cold; Temperatures at 30° latitude: Low -40°F, Average 0°F, High 40°F; Surface Water: 0%; Humidity: 1%; Primary Terrain: Desert.

Mars' terrain is not as diverse as Tellus'. It ranges from the ancient seabeds and vast deserts through the craggy mountain ranges and polar icecaps. It includes both the largest volcano in the solar system, *Olympus Mons*, and the largest canyon, the Mariner's Valley. It lacks, however, any terrain characterized by life. Nothing on Mars could be called a forest or a prairie.

Until the invention of the Bergenholm, the only water on Mars was frozen into its ice-caps or miles below its rusty surface. Some feeble plant-life grew along the banks of the prehistoric, massive system of canals (including *ari-yage*, the source of ladolian). Deep beneath the surface of those bone-dry channels, ancient aquifers held the traces of water that supported all remaining life on Mars.

The ponderously thoughtful Martians agreed that some more water would be good for Mars, never imagining how quickly the Tellurians would alter their world.

The Bergenholm has changed the face of Mars unrecognizably. Huge meteoroids of ice from the asteroid belt have resuscitated the dying planet, and the canals again run with the life-giving liquid. Many forms of Martian life have survived the millions of years of drought, such as the comedic "digger," a crab-like animal that tries to elude predators by burrowing into whatever surface it currently rests on, regardless of how hard it is. Most are now unable to tolerate the increased humidity and are dying out (ari-yage does not seem to be one of them, to the dismay of law enforcement — it is thriving in the moister clime), but the former ocean depths are submerged again and soon Mars will be much more comfortable for humans.

## Nevia

### First Galaxy

Planet Type: Tellus-like; Diameter: 72,654 miles; Gravity: 2.00G; Density: 1.2; Composition: Silicate; Axial Tilt: 27°; Seasonal Variation: Tellus-like; Length of Day: 41.3 hours; Length of Year: 1,944 days. Three giant moons, seven small and many moonlets.

Atmospheric Pressure: Thin; Composition: Oxygen-nitrogen; Climate: Hot; Temperatures at 30° latitude: Low 70°F, Average 110°F, High 150°F; Surface Water: 93%; Humidity: 90%; Primary Terrain: Islands.

Nevia's days are lit by a fervent blue sun set in a deep red sky. The air is nearly saturated with humidity, and as the temperature plunges each night, it rains torrentially.

The majority of Nevia's land lies under shallow seas, though in many areas, the ocean floor plunges to great depths, and a myriad tiny islands dot the surface. The amphibious Nevians build their towered cities in these plentiful shallows and islands, connected by many canals for convenience, while the lower regions are dominated by an intelligent race of true fish, "the denizens of the greater deeps."



Nevia is almost completely lacking in iron and other heavy metals. Their plastics industries are correspondingly highly advanced, and their technology makes very efficient use of what metal can be obtained. It was a quest for iron supplies that led Nerado to discover the solar system and the Triplanetary League.

## Onlo (Thrallis IX)

### Second Galaxy

Planet Type: Ice-ball; Diameter: 17,435 miles; Gravity: 0.68G; Density: 1.7; Composition: Methane-ammonia; Axial Tilt: 7°; Seasonal Variation: None; Length of Day: 11.65 hours; Length of Year: 135,050 days. Partial rings.

Atmospheric Pressure: Very thin; Composition: Helium-exotic; Climate: Palain-like; Temperatures at 30° latitude: Low -488°F, Average -483°F, High -478°F; Surface Water: 0%; Humidity: 7% (liquid helium); Primary Terrain: Plains.

Boskonian operations in the Second Galaxy were divided at a very high level into two parts, both controlled from the Thrallis system. Operations involving Tellus-type planets and peoples were controlled from Thrale (Thrallis II), while Z-types were directed by Onlonians from their home planet. Onlo is an Edenic planet to many Z-type races and after the War became a major tourist attraction to those peoples. It is home to a major Patrol base and a campus of the Palainian Institute of Technology and Sciences.

## Palain VII

### First Galaxy

Planet Type: Ice-ball; Diameter: 17,710 miles; Gravity: 0.73G; Density: 1.8; Composition: Silicate; Axial Tilt: 174°; Seasonal Variation: None; Length of Day: 9.74 hours; Length of Year: 179,876 days. Three moonlets.

Atmospheric Pressure: Very thin; Composition: Helium-exotic; Climate: Palain-like; Temperatures at 30° latitude: Low -490°F, Average -485°F, High -480°F; Surface Water: 0%; Humidity: 5% (liquid helium); Primary Terrain: Hilly/Rough.

It is not obvious to a strictly three-dimensional life-form that Palain is inhabited at all. All life-forms on this frozen planet have metabolic extensions into the hyper-dimension, which three-dimensional senses have great difficulty perceiving. Those few structures Palainians build appear to be no more than odd jumbles of rock. Even the Galactic Patrol's Z-Base and the main campus of the Palainian Institute of Technology and Sciences, both of which include several buildings equipped to support "fire-blooded" three-dimensional beings, are easily missed in the jumbled landscape.

Palainians are without a doubt the most intelligent species on their planet, but until long after they joined the Galactic Union, they were well below the top of the food-chain of their ecology. Many hyper-dimensional predators roamed the planet, against which the Palainians had few defenses. Their technology was well capable of slaying those creatures, but the most dangerous predators had evolved a psychic attack that paralyzed its prey with sheer terror. It is not certain that all such creatures of prey have been eliminated, and travelers to Palain are advised to be wary.

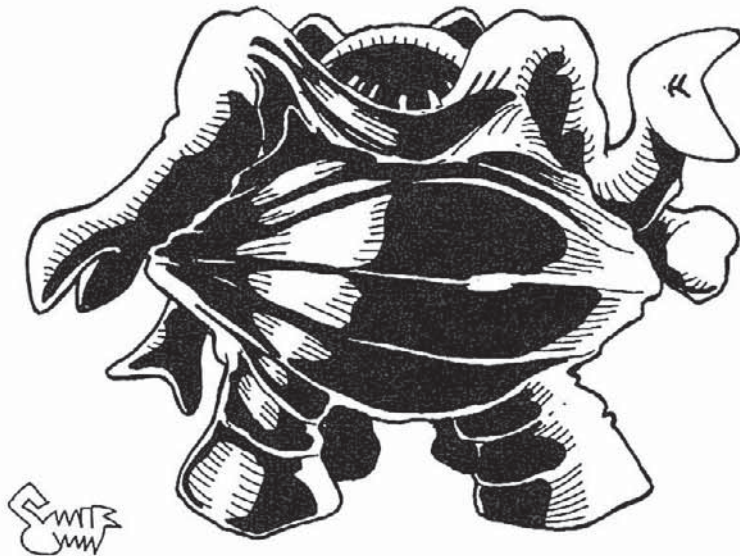

### **Ploor (Rontieff I)**

Planet Type: Tellus-like; Diameter: 18,653 miles; Gravity: 3.25G; Density: 7.6; Composition: Metallic; Axial Tilt: 67°; Seasonal Variation: Starkly Unimaginable; Length of Day: 49.3 hours; Length of Year: 19,396-20,096 days.

Atmospheric Pressure: Ranges from Very Thin to Dense; Composition: Ranges from Helium-exotic to Corrosive; Climate: Extreme; Temperatures at 30° latitude: Low -450°F, Average N/A, High 390°F; Surface Water: 0-99.8%; Humidity: 0-100%; Primary Terrain: Unpredictable.

Ploor's sun is so variable that it covers nearly the entire range of stellar types. Ploor's orbit around this star is highly eccentric and is frequently perturbed by the gravity wave created by its sun's dramatic changes in size. Its native life-forms either estivate for extremely long periods, or undergo radical changes, not only of form but of organization.

### **Pluto (Sol IX)**

Planet Type: Ice-ball; Diameter: 6,565 miles; Gravity: 0.23G; Density: 1.5; Composition: Silicate; Axial Tilt: 103°; Seasonal Variation: Gross; Length of Day: 90.8 days; Length of Year: 90,710 days.

Atmospheric Pressure: Very thin; Composition: Helium-exotic; Climate: Palain-like; Temperatures at 30° latitude: Low -490°F, Average -485°F, High -480°F; Surface Water: 0%; Humidity: 3% (liquid helium); Primary Terrain: Hilly/Rough. One giant moon, Charon.

Pluto is a tiny world considered desolate even by the Palainians who established a colony there. It is notable only for having the largest moon in proportion to its primary in the solar system. The Palainian Institute of Technology and Science maintains a deep-space observatory there, and the Oort bases of the Solarian Distant Early Warning Line (a hold-over from the days before hyper-spatial tubes) is coordinated from Charon.

### **Rigel (β Orionis IV)**

Planet Type: Tellus-like; Diameter: 21,261 miles; Gravity: 2.09G; Density: 4.3; Composition: Low-iron; Axial Tilt: 19°;

### **Second Galaxy**

### **Tellus (Sol III)**

Planet Type: Tellus-like; Diameter: 7,929 miles; Gravity: 1.00G; Density: 5.3; Composition: Medium-Iron; Axial Tilt: 23.45°; Seasonal Variation: Tellus-like; Length of Day: 24 hours; Length of Year: 365.24 days. One giant moon: Luna.

Atmospheric Pressure: Standard; Composition: Oxygen-Nitrogen; Climate: Tellus-like; Temperatures at 30° latitude: Low 30°F, Average 60°F, High 90°F; Surface Water: 72%; Humidity: 50%; Primary Terrain: Forest/Steppe.

Most inhabited planets are "Tellus-type" worlds and the eponym of that type is indeed of a common sort.

Tellurian life is mostly harmless. There are no exceptional predators; in sheer viciousness, the dominant species, humanity, far exceeds any other animal life. Humanity's ruthlessness is remarkable, but an obvious product of its heredity. The race is utterly lacking in natural abilities of any sort with the single exception of its unstoppable drive. Once a human has decided on a course of action, it is very difficult to cause him to alter it. This stubbornness was the deciding quality in the creation of the new Guardians of Civilization. Rigellians can be swayed by reason; Palainians can be deterred by fear; Velantians abandon plans on a whim; humans, however, are a stiff-necked people.

Prime Base, the center of Galactic Patrol operations in the First Galaxy, sprawls for many hundreds of square miles around The Hill — formerly Cheyenne Mountain in central Colorado, North America. It is surpassed in size and armament only by Ultra Prime, on Klovvia.

### **Trenco**

Planet Type: Rock-ball; Diameter: 5,500 miles; Gravity: 0.35G; Density: 2.8; Composition: Silicate; Axial Tilt: 0°; Seasonal Variation: None; Length of Day: 26.2 hours; Length of Year: 82 days.

Atmospheric Pressure: Dense; Composition: Exotic; Climate: Unique; Temperatures at 30° latitude: Low -20°F, Average 50°F, High 110°F; Surface Water: 0%; Humidity: 100% (trencine); Primary Terrain: None.

### **First Galaxy**

### **First Galaxy**

Trenco is unique. Whatever combination of events resulted in its creation, they were never repeated in any known galaxy, and the many theories are hotly debated by planetologists wherever situated. (While the Guardians of Civilization are certainly able to deduce the original conditions from the present, they have not published their results.)

Trenco's hydrosphere consists solely of *trencine*, a nitrogenous hydride with an extremely low heat of vaporization — a puddle in the palm of a human's hand will quickly evaporate, without cooling it perceptibly. During Trenco's scaldingly hot day, then, it is all vapor. During the night, exactly forty-seven feet and five inches of liquid precipitate, and each morning it all evaporates in a matter of minutes.

Under normal conditions, this condensation and evaporation would be quieter and gentler than Tellurian dew. A low heat of vaporization means very little energy transfer, and if *trencine* were Trenco's only peculiarity, it would be as thermodynamically exciting as a goldfish bowl. However, *trencine* is very strongly paramagnetic — it amplifies whatever magnetic field is applied to it — and Trenco has one of the strongest magnetic fields ever measured on a rocky planet.

Trenco orbits its huge blue-white sun quite closely. That star's plasma wind is powerful enough to draw Trenco's magnetic field out from its night side into an extremely long magnetotail. During the day, both the magnetosphere and the belt of charged particles it has trapped from the stellar wind (similar to Tellus' "Van Allen Belts" but far stronger) are forced down to Trenco's surface. There, the paramagnetic *trencine* vapor in the atmosphere amplifies and warps the magnetic field, creating vortices of radiation that would kill an unprotected human in minutes.

This magneto-acoustic turbulence causes current flow — lightning. Not flashing bolts as on pastoral Tellus. Quasi-solid sheets crash from the sky in unending cascades that fill both the ether and sub-ether with incredible interference. The energy released by the lightning in turn causes winds, which create more turbulence and electrical discharges in a feedback cycle that builds swiftly to utterly indescribable violence. There is almost no place or time on Trenco at which a Tellurian gale would not be considered utter calm. At dusk and dawn, as the magnetosphere rises above and enters the atmosphere and the lightning intensifies, the winds become super-sonic.

This chaotic turbulence whips Trenco's magnetosphere into a flux that distorts the very space-time continuum itself. Near Trenco's surface, distance and direction are wildly variable, and may well include loops. Not only is every sense save that of direct perception insanely overwhelmed, but a beam weapon's ray may well "curve" around so as to strike the firer.

Lightning and wind have polished Trenco to a smoothness unknown on any other solid planet. Its landscape has *no* features. It does, however, support thousands of life-forms, both animal and plant. All share three characteris-

tics: they are amphibious, streamlined and omnivorous. The plant forms are not chlorophyll-based; rather, their photosynthesis relies on *thionite*. Thionite is discussed elsewhere in this manual; let it here suffice to say that it is the sole reason that the sixth-largest Patrol base ever constructed was built in the hellish environment of Trenco.

## Valeria

## First Galaxy

Planet Type: Tellus-like; Diameter: 16,710 miles; Gravity: 2.76G; Density: 7.2; Composition: Metallic; Axial Tilt: 43°; Seasonal Variation: Strong; Length of Day: 31 hours; Length of Year: 284 days. Partial rings.

Atmospheric Pressure: Dense; Composition: Polluted; Climate: Tropical; Temperatures at 30° latitude: Low 70°F, Average 95°F, High 120°F; Surface Water: 32%; Humidity: 23%; Primary Terrain: Hilly/Rough.

Valeria is the most hellish planet unprotected humans *can* survive on. They are not *likely* to survive, but it is barely possible. The crushing gravity, corrupting air, searing temperatures, heavy-metal-poisoned earth and water and ravaging background radiation levels were overmatched by the human desire for the abundant diamonds and other high-pressure crystals, created by Valeria's extreme tectonic activity. The ecology those factors produced very nearly matched that overpowering greed with its lust to kill. Valerian life is tough, strong and fast. The first expedition was destroyed in six minutes, by the plants their landing jets had scorched. Following expeditions learned from their predecessors, and overcame the prowler packs, the thornwing flocks, the *tatzwurmen*. . . . Within a year, the first Valerian diamonds began to flood the jewel markets of Civilization. Within a decade, the first generation native Valerians were proving themselves worthy of their environment — tough, strong and fast.

The Galactic Patrol maintains several hostile-environment training bases on Valeria.



## Vegia ( $\alpha$ Lyrae V)

### First Galaxy

Planet Type: Tellus-like; Diameter: 9,012 miles; Gravity: 1.14G; Density: 5.5; Composition: Medium-iron; Axial Tilt: 32°; Seasonal Variation: Strong; Length of Day: 22.1 hours; Length of Year: 2,007 days; Two large moons.

Atmospheric Pressure: Standard; Composition: Oxygen-nitrogen; Climate: Cool; Temperatures at 30° latitude: Low 50°F, Average 60°F, High 70°F; Surface Water: 84%; Humidity: 32%; Primary Terrain: Prairie.

Vegia abounds with scents of all types, since much of Vegian communication is olfactory. (The oft-repeated idea that aroma to a Vegian is analogous to body language to a Tellurian makes little sense, since body language is extremely important to a Vegian as well.)

Vegians are a friendly people, but at the same time are strongly clannish. Outside acquaintances find that their welcome extends only to certain rigid limits. Vegian society is also noted for its love of gambling of all kinds, and of languages.

Vegia was one of the initial adherents to Civilization; as the Galactic Patrol was formed, General Armand assumed command of its Vegian arm.

## Velan (Velantia III)

### First Galaxy

Planet Type: Tellus-like; Diameter: 8,453 miles; Gravity: 1.16G; Density: 6.0; Composition: Medium-iron; Axial Tilt: 9°; Seasonal Variation: minor; Length of Day: 40 hours; Length of Year: 201 days. Two large moons, one small.

Atmospheric Pressure: Dense; Composition: Oxygen-nitrogen; Climate: Hot; Temperatures at 30° latitude: Low 100°F, Average 110°F, High 120°F; Surface Water: 59%; Humidity: 21%; Primary Terrain: Hilly/Rough.

Velan abounds in wind-swept badlands much like the western regions of central North America, which are the favored terrain of a wide variety of flying reptiles including Velantians themselves. Many of them delight in aerobatics within narrow and twisting canyons, and several different sports are played based on such skills.

Velantians are not a numerous race; the Overlords' rapacity never allowed their population to grow beyond a few hundred million. However, now that there are no limits on their growth, their population is booming. Emigration is very popular among the young and colonizable worlds are aggressively sought.

The Velantian Galactic Patrol base rivals Prime Base in several aspects. Most weapons system development and testing is carried out by Velan Base.

## Venus (Sol II)

### First Galaxy

Planet Type: Greenhouse; Diameter: 7,566 miles; Gravity: 0.90G; Density: 5.3; Composition: Medium-iron; Axial Tilt: 179°; Seasonal Variation: none; Length of Day: 117 hours, retrograde; Length of Year: 224.7 days.

Atmospheric Pressure: Dense; Composition: Polluted Oxygen-Nitrogen; Climate: Highlands Hot, Lowlands Very Hot; Temperatures at 30° latitude: Low 100°F, Average 120°F, High 140°F; Surface Water: 98%; Humidity: 100%; Primary Terrain: Highlands Hilly, Lowlands Swamp.

Venus is a sodden hothouse world, fecund with clouds, rain and life of all sorts. It is a cornucopia of organics, producing



much of the medical supplies for the human sector of Civilization. Humanity here can live for long periods only in the mountainous highlands of Ishtar and Aphrodite. The extreme air pressure in the lowlands causes a variety of respiratory ailments in humans when breathed for more than a few hours.

The native animal life of Venus is savage in the extreme. One particularly vicious example is the Venerian slasher-worm, an amphibious horror that inhabits shallow, muddy waters and preys on passing animals by hamstringing or fully amputating their lower limbs with its powerfully driven tail, tipped with a wickedly curved bone cleaver. Venus' plant life is not much more peaceful, though Tellurian flora will grow well there, if defended. Venerian tobacco, orchids and mushrooms are widely popular.

The Venerian race is quite populous, dotting the coastal lowlands with their half-submerged towns and cities.

## Zabriska (A-Zabriskae II)

### First Galaxy

Planet Type: Rock-ball; Diameter: 3,200 miles; Gravity: 0.43G; Density: 5.8; Composition: Medium-Iron; Axial Tilt: 0°; Seasonal Variation: None; Length of Day: 314 days; Length of Year: 314 days.

Atmospheric Pressure: None; Temperatures at 30° latitude: Low -484°F, Average N/A, High 475°F; Surface Water: 0%; Humidity: 0%; Primary Terrain: None.

Zabriska orbits a blue-white giant, which itself is one of a trinary star system. (B-is a bluish yellow giant and C-is a yellow dwarf.) Zabriska itself is a small, airless, utterly barren rock-ball. It is tidally locked to A-Zabriskae, so the far side is only slightly warmer than absolute zero, while the sunward side is hot enough to melt sulfur. It is extremely smooth, with no surface features at all. Its surface temperature is about 475°F. It is inhabited by one known species.

A Zabriskan fontema is a small creature consisting of two paddle-wheel-like extremities, about two inches wide and three inches in diameter, on either end of a eight-inch central axle. It is "solar-powered," an ergivore, directly consuming radiation. It neither eats nor excretes in any other way. It moves by rolling, and it only stops rolling to reproduce. If it should run into something (very unlikely on featureless Zabriska), it will continue to roll forward, skidding in place, unable to avoid the simplest obstacle. This simple existence has made a fontema a symbol of mindlessness — having "the brains of a Zabriskan fontema" is not a compliment.



# TECHNOLOGY

## CHAPTER FIVE

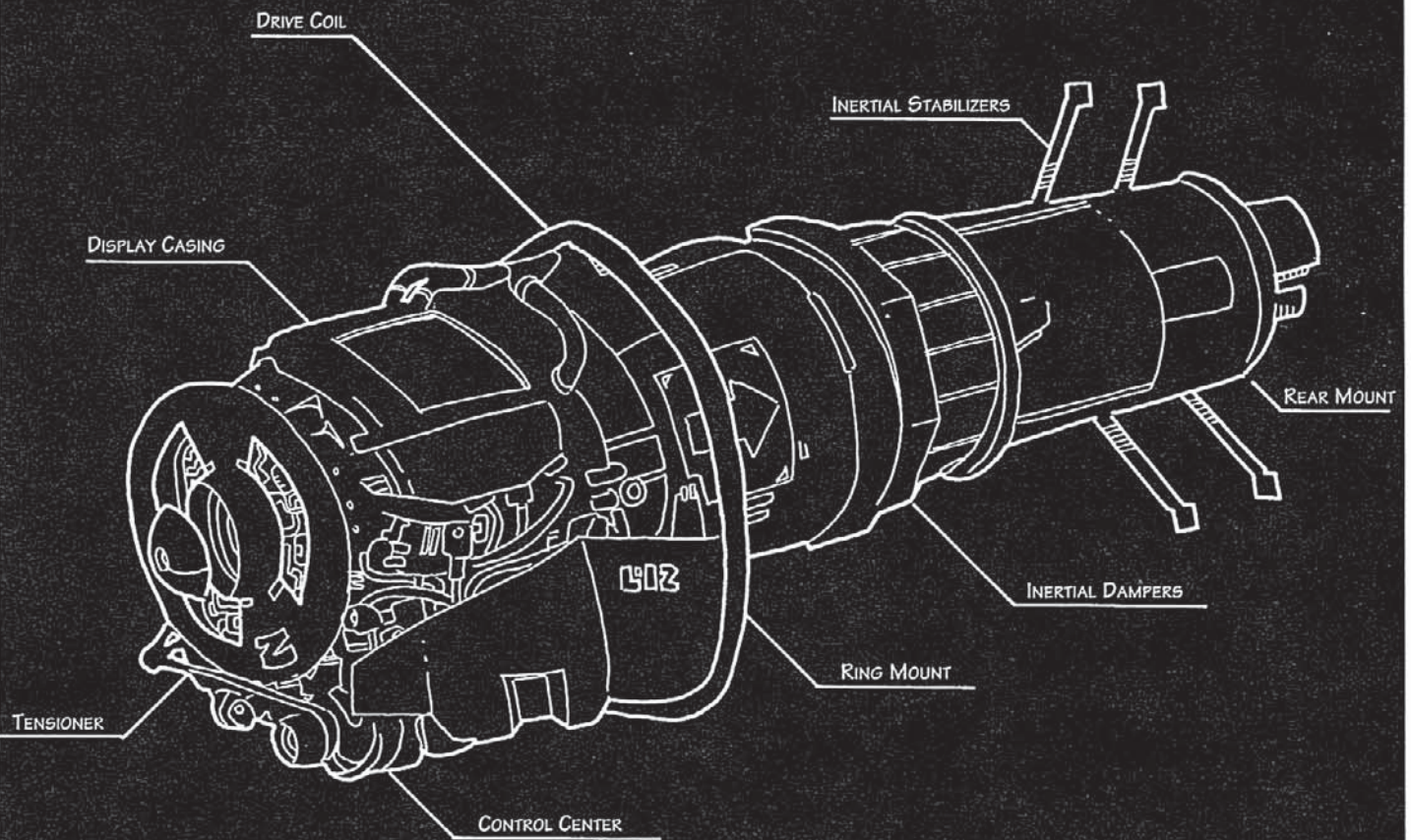

### INERTIALESS DRIVE ENGINE

SCALE: 1/60

APPROVED BY

DRAWN BY

DATE: 4/6/61

*W. P. Ferguson*

SMF

REVISED 11/24/93

MANUFACTURER: PARTI-TELLUS INC - MECH DIV-3

SOLARIAN LEAGUE CLASSIFIED

DRAWING NUMBER

42863-D

## ● TECHNOLOGY STAGE

Since the Civilization of the Lens was interdicted from development of the transistor, its technology evolved along paths not well represented by *GURPS* Tech Levels. Instead, the history of Civilization is divided into Technology Stages, as shown in the sidebars. Tech Stage 0 begins at the end of the Atomic Phase of the Tellurian World War — just after Tech Level 6. The episodes in *Triplanetary* take place before and during Tech Stages 0 through 3. *First Lensman* and *New Lensman* are set in Tech Stage 4. The period immediately following those stories is Tech Stage 5 and *Galactic Patrol* is 6. *Gray Lensman* is set in 7, and *Second-Stage Lensmen* in 8. The Reconstruction immediately following the war is Tech Stage 9. *Masters of the Vortex* and Kyle's trilogy are in Tech Stage 10, and *Children of the Lens* is in Tech Stage 11.

An extremely rough correlation can be forced between Tech Stages and Level. Tech Stage 0 is equivalent to Tech Level 6, and TS 1 is approximately TL 7. Stages 2 and 3 could be compared to TL 8, though the *GURPS* Tech Level does not account for allotropic iron as a power source. Then Stage 4 is slightly analogous to TL 9 and 5 to 10, but then all of Tech Stages 6 through 8 must be lumped into TL 11. Finally Stages 9-10 could be called TL 12. It must be emphasized that these are loose and muddy comparisons — Civilization developed planetary missiles (TL 13) many years before antimatter missiles (TL 11), and jumped from being unable to cure infantile paralysis (TL 6) to full regeneration (TL 12) in one step. GMs who allow equipment into a *Lensman* campaign solely on the basis of technological rating will encounter difficulties.

Any rules which apply numerical factors involving Tech Levels will apply those same factors to Tech Stages. For example, those skills which are different at different Tech Levels also differ by Tech Stage, and suffer the same penalties for operating out of the appropriate Tech Stage. A electronics technician from TS 5 is at a -5 to repair a TS 2 dirigible missile, and at -15 to work on a TS 8 tractor zone.

## ● ELECTRONICS

*Dr. Eickemeyer broke the anode-coupler circuit, and the output ammeter's needle slammed over and wound the needle around the stop pin. The paint on the radiator fins of the external high-dissipation shunt burst explosively into a cloud of acrid, greasy smoke, revealing the redly-glowing busbar itself. It proceeded to melt, sputtering in flying droplets of scintillating molten metal.*

*Dr. Eickemeyer closed the coupler circuit.*

It is important to understand the effects of vacuum-tube technology on electronics. Vacuum tubes have several advantages over semiconductor components, the most obvious being their ability to easily handle far higher power levels. Semiconductors are comparatively delicate electronically; voltage surges that tubes ignore would destroy a solid-state circuit. While vacuum tubes are individually fragile physically, they can be shock-mounted in use so that the equipment as a whole is quite rugged. Diagnosis and repair of vacuum tube equipment is easy and cheap. Individual tubes are simple to remove, test and if necessary replace. It is almost never necessary to swap out entire circuit boards.

On the other hand, vacuum tubes burn out much more frequently than solid-state components; a life expectancy of some 2,000 hours is typical. When they are severely misused, they can burst in a shower of glass and leaping electrical arcs. Vacuum-tube equipment requires much more power than transistorized, and gets much hotter. Heat dissipation is a important factor of equipment design, and the higher powers are dangerous to technicians. Instead of the 5 volts at a few milliamps found on an integrated-chip circuit board, a vacuum tube is considered "medium-voltage" if it operates at 500 to 2,000 volts anode potential with about half an amp of current. A single high-power tube may consume 20 kilowatts. The danger of electrocution is obvious.

As a very rough general rule, a device built with Civilization's ultra-micro-miniature vacuum tube technology will be twice as large, two-and-a-half times as

## Tech Stages — History

- 0 The Tellurian World War (1901-1963)
- 1 The Recovery
- 2 Jovian War
- 3 Triplanetary-Neveian War
- 4 Galactic Union and Patrol formed; Rigel IV and Palain VII join
- 5 Anti-piracy police actions; Academy founded
- 6 Anti-piracy actions continue; Velantia joins the Galactic Union
- 7 Boskonian War; Medon joins the Union; Phillips regeneration
- 8 V-B Day
- 9 Reconstruction
- 10 Electronic computers
- 11 Cleanup of the Spawn of Boskone



## Transportation and Communication

- 0 Automobile; aircraft; ocean liner; submarine
- 1 Suborbital rocket shuttles
- 2 Interplanetary flight; ultra-wave communicator; spy-beam; display tank
- 3 Inertialess drive; thought-broadcaster
- 4 The Lens
- 5
- 6 Thought-screens; detector-nullifiers
- 7 Nullifier-scrambler
- 8 Hyper-spatial tube

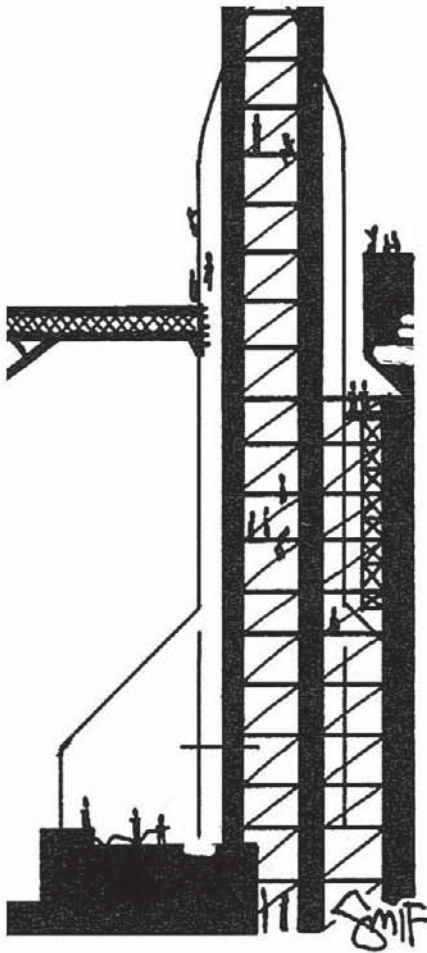

### Weapons and Armor

- 0 Battleship; tank; machine-gun; fighter aircraft; fission bomb; flak jacket
- 1 ray guns; vee-two gas; force shields; dirigible missile
- 2 Needlers, cyclonite
- 3 Tractor and pressor beams, tractor-shears; Q-gun
- 4 Macro beams
- 5-6 DeLameters, duodecapylatamate
- 7 Primary beams; free planets; negaspheres; dureum
- 8 Tractor zones; death ray; sunbeam
- 9 Super-atomic bombs
- 10 Deliberate atomic vortices
- 11 Nth-space free planets

### Power

- 0 Hydroelectric power; alternating current
- 1-2 Atomic power
- 3 Allotropic iron
- 4-5 Atomic motors and generators
- 6 Cosmic ray absorption
- 7 Super-conductors, super-insulators and super-atomic power

heavy and consume five times the power as that same device described in *GURPS Ultra-Tech*. Again, GMs are strongly cautioned to consider the ramifications of *Ultra-Tech* devices on a *Lensman* universe before allowing them to be developed. Any concept that would contaminate Civilization's development will be ruthlessly suppressed by Mentor. (See *History and Society* for a discussion of Mentor's criteria for Civilization's technology.)

## SHIP CONSTRUCTION

This section supplements the rules in *GURPS Space*, which is required to completely design ships of space. Some elements of astronomical architecture are not covered here and can be found in that reference.

However, the components described here are beyond the scope of *Space* and *Vehicles*. The ships of space that fought the Boskonian War are not comparable with anything that could be designed with those books. For example, at TS6, the *Dauntless'* cosmic ray absorption screens could produce four million pounds per hour of energy. That is *44 million million megawatts*.

Thus, items described in *Space* or *Vehicles*, could — with GM approval and modification — be incorporated into a *Lensman* ship, and their power requirements are all negligible. However, no vehicle designed with those rules is capable of powering any device listed here.

Because of Civilization's excellent economy, divide all prices listed in *Space* or *Vehicles* by ten. Shipbuilding is a tremendous industry throughout the galaxies. The Galactic Patrol mustered an estimated 80 million ships for the attack on the Second Galaxy. (Tellus alone contributed 80 super-dreadnoughts plus the Z9M9Z).

### Hull

Because no material substance can withstand for a moment the inconceivable energies of space combat, armor is not emphasized on warships. Because the Bergenholm inertialess drive reduces inertial mass to zero, light-weight materials are not emphasized either. Throughout the Boskonian war, ship hulls mass 0.01 tons per cy and cost \$5 per cy.

### Aerodynamic Streamlining

TS	Type	Cost	Volume	Speed Factor
0	Average (irregular)	×1	0%	×1
2	Very Good (sphere)	×1	0%	×1.2
4	Superior (football)	×2.5	0%	×1.5
6	Excellent (tear-drop)	×5	5%	×1.9
8	Radical (cigar)	×10	5%	×2.5



The maximum speed a ship can attain is that at which the driving force of its jets is matched by the resistance of the interstellar gas. Proper streamlining greatly increases a ship's speed.

The hull's cost and mass assumes "very good" streamlining: a sphere, with many external fittings for antennae, projectors and weapons. ("Very good" is the point of diminishing returns — it is cheaper to streamline at least this well than it is to add more engines.) The Galactic Patrol's maulers are the prime example of the "superior" (American) football shape, and the scouts teamed with those maulers are "excellently" streamlined tear-drops. "Radical" streamlining — an area-ruled narrow cylinder design with a sharply pointed nose and very few external fittings used on speedsters — is not available before TS8 and never available to civilians.

The cost and volume factors are added to the hull cost — a hull with a base cost of \$10,000 credits can be given superior streamlining for another \$25,000, and a 1,000 cy hull loses 50 cy to excellent streamlining.

### **Accommodations and Life Support**

The ship's crew needs a place to call home; sleeping space, mess hall, kitchen, recreation area, and more. Accommodations total \$400, 1 ton and 25 cy per crew member. On military vessels, every person on board is considered to be a crewman. Passengers (on space liners and such) have different requirements, depending on the luxury of the accommodations:

- Steerage:* ½ ton, 12 cy, \$100 per passenger.
- Standard:* 1 ton, 20 cy, \$300 per passenger.
- First Class:* 2 tons, 40 cy, \$600 per passenger.
- Luxury:* 3 tons, 100 cy, \$3,000 per passenger.

A continually-operating life support system, which recovers and recirculates all air and water the crew and passengers need, requires 2 tons, 4 cy and \$500, plus ½ ton, 2 cy and \$50 per person supported.

### **Power Plant**

Any ship needs a power source. Power is measured in *pounds per hour* (lb./hr.) — as a comparison, the largest atomic explosion ever detonated on Tellus (60 megatons at Novaya Zemlya, about a year before the Third, or Atomic, Phase of the Tellurian World War) released 7.3 pounds of energy for a very short period of time. When designing a large ship, it is a good idea to provide some extra power capacity. It may also be wise to have two or more separate power plants, even though this is more expensive, in case one is lost to accident or combat.

### **Accumulators (TS2)**

Accumulators store electricity and release it upon demand. They are rated in pounds of energy. A 1 pound accumulator provides the same power as a 3,600 pound per hour power plant — for *one second*. If an accumulator is rated at 20 pounds, it can be fully recharged by 20 hours of output from a 1-pound-per-hour plant, 2 hours from a 10-lb./hr. plant, one second from a 72,000-lb./hr. plant, and so on. An accumulator masses 5 tons, takes up 1 cy and costs \$2,000 for every 1,000 pounds of energy it holds.

Accumulators' typical uses include nearly any application in which a high demand will occur for a short time, such as starting cosmic ray absorption screens and powering needler-beams (both below).

Damage to accumulators can release all the stored energy at once, with explosive results.

### **Allotropic Iron Converters (TS3)**

The most stable isotopes in the universe, at the bottom of the curve of binding energy, are iron. They can neither be fused nor undergo fission without *adding* energy to them. Allotropic iron is a potent fuel, yielding one-tenth of its mass up as useful energy. Thus, ten pounds of allotropic iron will produce one lb./hr. of power for one hour.

## **Units**

Civilization officially uses the *Système International d'Unités*, or "metric" system, although the ancient Standard American Engineering system of units — feet, pounds, quarts — still has its adherents. However, many engines consume or produce so much power that even measured in terahorsepower or terawatts the numbers become unwieldy. Hence, their power is usually expressed in *pounds per hour* — the amount of power equal to the total conversion of a pound of mass every hour, about 15.2 gigahorsepower or 11 terawatts — or even *tons per second*.

By way of comparison, a one megaton atomic bomb releases about 1.75 ounces of energy (1.56 gigahorsepower-hours), and the entire power output of a TS 3-world is usually about a quarter-pound per hour (4 terahorsepower or 3 terawatts).



## **Dimensions**

An ordinary ship of space, with "very good" lines, is basically a sphere. To find its dimensions, take the cube root of its volume in cy. Its radius in yards is about two-thirds of that number, so a 1,000,000 cy freighter is about 400 feet in diameter.

A ship with "superior" lines is football-shaped. Its length is roughly twice the cube root of its volume, while its diameter is equal to it. Thus, a 100,000-cy freighter is about 280 feet long and 140 feet in diameter.

An excellently streamlined ship is shaped like an elongated tear-drop. Its length is three times the cube root of its volume and its diameter is equal of it. Thus, a 1,000,000-cy dreadnought is some 900 feet long and 300 feet in diameter.

A radically streamlined ship is shaped like a cigar with a wasp-waist. Its length in yards is nine times the cube root of its volume in cy, and its diameter half of it. Thus, a 10,000-cy ultra-fast speedster is 516 feet long and 32 feet in diameter.



Four allotropes of iron, or ferrites, were known before the arrival of the Nevians, symbolized  $\alpha$ ,  $\beta$ ,  $\gamma$  and  $\delta$ . The "alpha" form is the only one that can exist at room temperature; the others form only at high temperatures below iron's melting point.

The Nevians perfected a technique of ultra-wave prompt cascade bombardment that transformed the common "alpha" form into a previously unknown "epsilon" form. The "epsilon" allotrope is a strongly diamagnetic (repelled from either pole of a magnet) viscous liquid at room temperatures with a density of 16.2 tons per cubic yard, or 21 pounds per pint. It is a dull red. A storage tank for allotropic iron must be well supported, costs \$1 per 100 lbs. capacity, and has negligible weight (when empty). It occupies 10% more volume than the allotropic iron it holds, but that is frequently a negligible amount.

### ***Cosmic Ray Absorption Screens (TS6)***

Cosmic ray screens tap into the continual flux of energy that permeates the ether and converts that energy into usable electricity. A "standard" cosmic energy screen produces 1,000 pounds per hour of power, masses 0.05 tons, takes up 0.1 cy and costs \$2.

Such screens suffer one disadvantage — it takes power to activate them. Once activated, they are self-sustaining, but they consume one-one hundred thousandth of their output. To start such a screen this power must be applied for a full second before it will become self-sustaining. Therefore, all ships using such screens carry accumulators or some other backup power supply. Most ships mount two or three power supplies as dedicated intake-screen exciters. *Dauntless*-class super-dreadnoughts mount 200.

If cosmic ray absorption screens are nested so that one is *completely* inside another, only the outermost will receive any power. Some ships and many ground installations mount enormous cosmic ray screens, far larger than their own power requirements (their excess output dumped into a well-cooled shunt) for the purpose of surrounding an attacker's screens and cutting him off from this source of power. Screens have a radius, in miles, from their generator equal to the square root of the power produced (in lb./hr.).

An installation with cosmic ray absorption screens needs no other sources of energy except a small starter supply, such as a bank of accumulators — unless there is concern that hostile forces might cut it off from cosmic radiation.

### ***Super-Atomic Motors and Generators (TS7)***

Super-atomic, or total conversion, motors and generators directly consume matter and convert it into either rotational or electrical energy. They are rated by output, usually in pounds converted per hour. If Medonian super-conductors and -insulators are not available, a motor or generator that will convert 1,000 pounds of matter an hour masses 15 tons, occupies 12 cy and costs \$150,000. With Medonian technology, that same engine masses 0.1 ton, occupies 0.04 cy and still costs \$150,000.

### ***Screens (TS1)***

Force shields can be tuned to either absorb electromagnetic or kinetic energy, in either case at a rate proportional to the cube of the incoming energy. Force shields intended to protect a ship of space from the inconceivable forces of combat are referred to as *screens* and are transparent to matter. Those tuned to stop material objects are called "meteor shields" regardless of their actual purpose, and are transparent to all radiation. Both types are essentially transparent to slow-moving objects and low-energy radiation such as radio and visible light, while absorbing hard radiation such as x-ray and gamma or stopping fast-moving matter.

A screen's strength is measured by its Defensive Factor (DF). A screen generator that gives a DF of 1 costs \$5, mass 0.02 tons, occupies 0.1 cy and consumes 0.2 lb./hr.. Multiply those numbers by the *square* of the DF, so a screen of DF 100 costs \$50,000, masses 200 tons, occupies 1,000 cy and consumes 2,000 lb./hr..

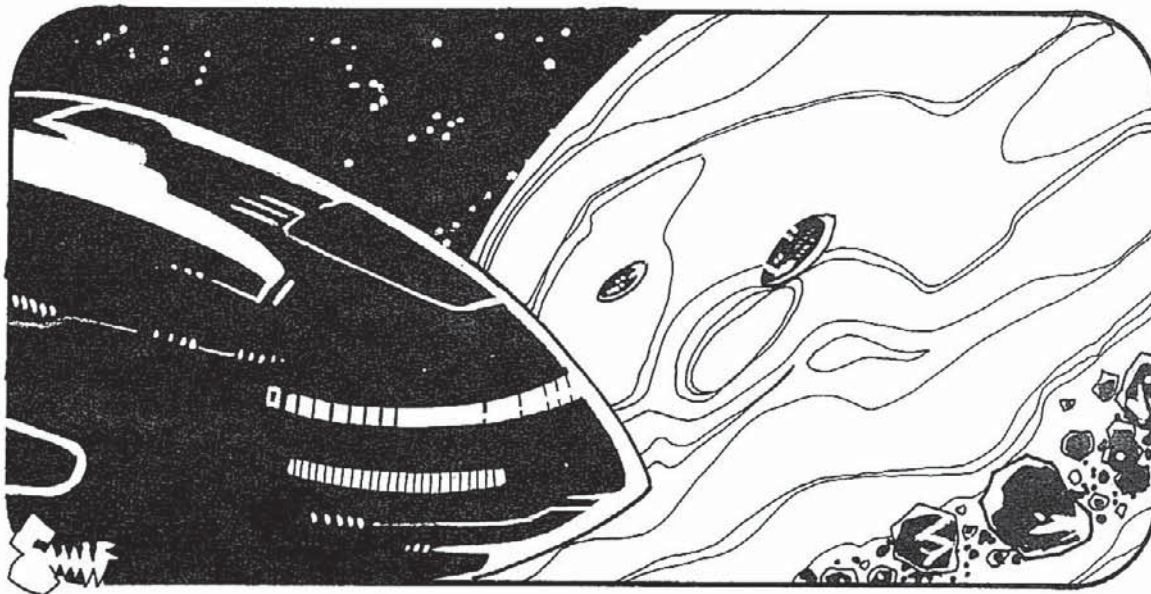

## “Driving Jets” — The Fourth-Order Nascent Corpuscle Drive (TS3)

Ordinary reaction engines (see p. S82-83) were used on ships of space prior to the invention of the Bergenholm, but they cannot be used while inertialess. Regardless of how fast the exhaust leaves the ship, if it has no mass, it has no momentum, and so no “reaction” driving the ship forward! And if the exhaust were somehow inerted on its way out, it would simply resume its intrinsic velocity, which not only has no effect on the ship, but is also almost certainly not pointed in the desired direction. Fortunately, the development of the Bergenholm inertialess drive led to other discoveries in the fourth order of forces, which includes mass, gravity and inertia, and made possible the creation of driving jets that do not rely on Newton’s Third Law — a reactionless engine!

“It is of course well known that all ships of space are propelled by the inert projection, by means of high-potential static fields, of nascent fourth-order particles or ‘corpuscles,’ which are formed, inert, inside the inertialess projector, by the conversion of some form of energy into matter. This conversion liberates some heat, and a vast amount of light. This light, or ‘flare,’ shining as it does directly upon and through the highly tenuous gas formed by the projected corpuscles, makes of a speeding space-ship one of the most gorgeous spectacles known to man.”

Driving jets provide 1,000 tons of thrust per 1.5 tons, 1 cy and \$200 of engines and consume  $\frac{1}{10}$  pound per hour.

The top speed an inertialess ship can achieve is determined by the force of its driving jets, the volume and streamlining of the ship and the resistance of the interstellar dust and gas. Divide the jets’ thrust in tons by the ship’s *volume in cubic yards* (not mass) to get its thrust ratio. Then multiply that ratio by the speed factor of the current interstellar medium (see p. 54) and by the streamlining factor to determine top speed. Cruising speed is two-thirds of top speed.

Thus, driving jets massing 4,500 tons, occupying 3,000 cy, costing \$600,000 and consuming 300 pounds per hour produce three megatons of thrust. They could propel a 50,000-cy mauler with superior lines at  $(3,000,000/50,000) \times 1.5 = 90$  parsecs per hour, though it would normally cruise at 60 pph.

Jets massing 900 tons, occupying 600 cy, costing \$120,000 and consuming 60 pounds per hour produce 600 kilotons of thrust. They could propel a 10,000-cy radically-streamlined speedster at  $(600,000/10,000) \times 2.5 = 150$  parsecs per hour, though it would normally cruise at 100 pph.

Jets produce the same thrust whether the ship is free or inert, so if the above mauler massed 50,000 tons, it could accelerate at 60 gravities. (The ship’s artificial gravity would reduce the perceived acceleration to 0.6 Gs — see p. 77.)

### Upkeep

Space ships, particularly military ones, must be maintained. Even in normal, peaceful use, bearings and cams wear, springs weaken, a myriad consumables are expended. Each year, a ship’s maintenance costs 10% of its replacement cost. Ships in new construction do not require upkeep, but those in refit or being repaired do.

Ships may be *mothballed*, which lowers upkeep to one-tenth the normal costs, but takes the ship out of service. Returning a ship from mothballs costs 10% of its replacement value and requires shipyard facilities for 10% of the time it would take to completely rebuild the ship.



## From Adventures in the Physical Sciences, Chapter Four: Inertia and Weight

The word "mass" tells us how a body reacts to *two different* forces. In the previous section, we learned that how hard something is to hold up when gravity pulls on it is "weight." In this section, we will learn what makes something hard to push around — "inertia."

In everyday life, we don't notice that "mass" means two different things, because those two things are exactly equal! For many thousands of years, nobody even knew that they were different. Even after the great Tellurian scientist Sir Isaac Newton explained the difference, it took over two thousand years before anybody could actually build a machine that would *show* the difference! Nowadays, when people use contragravity or the Bergenholm inertialess drive, it is easy to see the difference between "inertia" and "weight."

Everybody is used to "weightlessness." That's what happens when you're outside the pull of gravity, or when you're falling freely (as in orbit) or when contragravity is used to "turn off" the local pull of gravity. As we saw in Experiment 20, when weight goes away, an object is still hard to push around. A object that isn't moving tends to stay still. An object that's already moving tends to keep moving. That is inertia. Even when an object has no weight, it can still have inertia.

In the same way, an object can still have its weight, but be "inertialess." It is very easy to push something that is inertialess. If you were inertialess, falling down wouldn't hurt, because your clothes would stop your fall! In Experiment 23, you will see how easy it is to move an inertialess object. Perform Experiment 23 now.

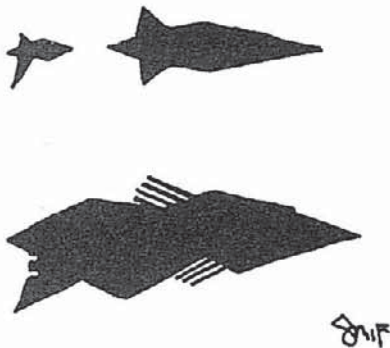

## The Bergenholm Drive

The Bergenholm inertialess drive allows interstellar and even intergalactic travel. With inertia neutralized, the ship has an inertial mass of zero and there is no limit whatever to its velocity. An inertialess, or "free," ship takes on instantaneously the velocity at which the force of her drive is exactly equaled by the friction of the medium in which she travels. Note that the Bergenholm provides no thrust on its own — thrust must be provided in some other way: gravity, traction and air resistance still work, although reaction engines do not. See *Driving Jets* above.

When an inertialess object becomes inert (regains its inertia), it instantly resumes whatever velocity it had when it went free. This can have catastrophic results if something is in the way of the now-inert object, since velocity differences of incredible magnitude can accumulate. Generally inertialess ships go inert in empty space, and use their jets to match intrinsic velocities with their destinations.

It is usually unimportant, but a Bergenholm does not activate instantaneously. To utterly zero all mass within its field takes a number of milliseconds roughly equal to the square root of the volume of that field. A 100,000-cy dreadnought takes over three-tenths of a second to completely "go free." Even a tiny 25-cy flitter takes five milliseconds to become completely inertialess.

Even though inertialessness means that no acceleration, however extreme, causes any physical reaction, there is still a "lashing, quivering awareness of speed which affects every mind, however hardened to free flight in the instant of change from rest to a motion many times faster than that of light."

*Personal Bergenholms (TL4)* cost \$5,000, weigh 20 lbs., take up 1 cubic foot (.04 cy), require one C cell and render 500 lbs. of mass inertialess.

*Shipboard Bergenholms (TL3)* cost \$10,000, weigh 5 tons and take up 15 cubic yards, plus \$10,000, 10 tons and 30 cy times the cube root of the volume taken free, regardless of mass. One pound per hour of power is required for every 1,000 tons rendered inertialess. Thus, a Berg that will free a 40,000-cy mauler costs \$350,000, weighs 345 tons and takes up 1,035 cy. If it masses 50,000 tons, it consumes 50 pounds per hour.

## Weapons

Each weapon has cost, mass and volume, just as other ship components. Weaponry of the previous tech stage will also be available at about 20% of stated cost, but will be comparatively less effective — see Chapter 7, *Combat*.

Also given is the weapon's *firepower* (FP), which takes in speed, accuracy, range and destructiveness. It must be emphasized that even the smallest ship-or base-mounted weapons are starkly irresistible by any physical matter, however refractory.

## Nevian Ferrosopic Ray (TS3)

The Nevians perfected a device that combined a Q-type helix of force coaxial with a tractor beam and a unique vibratory force than shifted iron into a previously unknown liquid allotrope. That liquid was then drawn up the force-tube by the tractor and stored in tanks. This device was not intended as a weapon. No beings with whom the Nevians had ever warred used iron for anything but a power source. However, when they encountered the ships of the Triplanetary Service, they found that their ferrosopic projectors were effective weapons against not only ferrous ships, but also against red-blooded humans.

The ferrosopic ray can be built in any size, and is rated in pounds of iron per second. Typical spaceships are three-quarters iron, so all the iron from a 10,000-ton passenger liner can be completely extracted by a 50 lb./sec. ferrosopic ray in 2.5 minutes. It will, however, be disabled almost instantly, as the iron cores of transformers are removed and sections of the hull liquefy.

Any being with hemoglobin-based blood exposed to a ferrosopic beam takes points of damage at a rate equal to the pounds of iron extracted. In the example given, the human passengers and crew will take 50 points of damage per second.

The ferrosopic ray is very easy to shield against. Any TL3+ force shields of any size will completely block ferrosopic rays.

A ferrosopic ray mount is operated by at least three crew, masses 70 tons, occupies 30 cy and costs \$5,000 plus three tons, 1 cy and \$100 per ton/second of capacity. The allotropic iron collected is assumed to be vented to space and lost unless storage tanks are provided (see *Allotropic Iron Converters*, above).

**Needlers (TS2)**

The main weapons of the space-ships of the Triplanetary League and later the Solarian League, emitted short pulses of actinic radiation, powered by the rapid discharge of accumulators. They continued to be used throughout the Boskonian War, though other weapon designs soon exceeded them in power, because of their accuracy and high energy-density. They are ideal for precisely disabling key positions. Heavier beams are used to weaken the enemy's screens, which would cause tremendous damage if used to completely batter down those screens. Then the needlers can locally overload those screens and carefully select their targets.

Needlers cost \$9,000, mass 50 tons, take up 50 cy, consume 1/2 lb./hr. and have a firepower of 200. Each projector is operated by a crew of three.

**Macro Beams (TS4)**

The invention of the primary beam projector did not render obsolete the beam weapons then in use, but it did relegate them to a secondary role. Even long after that time, "secondaries" were the main weapons of many warships. Primaries are far too massive, bulky and expensive to be mounted on small ships.

A macro beam is a force weapon, active as long as power is supplied to it. Thus, it can be used to "cut" its target, by swinging the projector. (Both needlers, above, and primaries, below, have very short beam durations.)

A macro beam mount with a firepower rating of 500 masses 100 tons, costs \$30,000, occupies 100 cy, and consumes 5 lb./hr.. Higher firepowers may be obtained at correspondingly higher parameters, but smaller mounts are not possible. Each mount is crewed by 25 beings.



**Primary Beams (TS6)**

The primary beam was invented by an unknown Boskonian gunnery officer who, witnessing the annihilation of Helmuth's Grand Base and realizing that he had only a Valerian space-axe or the lethal chambers of Civilization awaiting him, modified the main beam projectors of his fortress of space in a last great act of defiance. He died in his experiment, but he took with him fully nine of the mightiest of Civilization's ships of war. This officer realized that the beam-rods that produced what was heretofore the most annihilant energies known could be activated by other forces than electric current. Accordingly, he packed the resonant cavities of his weapons with an estimated full ounce of duodecapylatamate, surrounding the beam-rods on all sides save the muzzle.



**From Adventures in the Physical Sciences Lab Book, Experiment 23: Inertialessness**

Your teacher will give you the test balls and tracks for this experiment.

Step 1: Weigh the ball. Write the weight here:

Step 2: Set up the track. Put the black block under the end of the track marked "START", leave the other end of the track on the floor.

Step 3: Put your ball at "START", and let it roll down the track. Your lab partner should time it for you. Do this three times, and record how long it takes the ball to roll down the track here.

Time #1:

Time #2:

Time #3:

Step 4: Place the spring-loaded ram at the bottom of the track and cock it. Place the ball against the ram. Fire the ball up the track and record the height it reaches. Do this three times, and record the height here.

Height #1:

Height #2:

Height #3:

Step 5: Have your teacher activate your ball. Hold the ball in your hand and swing your arm back and forth. Notice how it now feels.

Repeat Steps 1 through 4 with the ball, which is now inertialess. Record your answers here:

Weight of the ball:

Time #1:           Height #1:

Time #2:           Height #2:

Time #3:           Height #3:

What do you think is the reason for the differences?



## From Adventures in the Physical Sciences, Chapter Four: Inertia and Weight

In Experiment 23, you saw that the inertialess ball weighed the same as it did when it had inertia, but it moved very differently. This is because gravity still pulled on it as hard as before, but without inertia, it was very easy to move. It was almost as if your hand were empty, but you could still feel the ball's weight.

When you rolled the inertialess ball down the track, it moved so fast you couldn't even see it, because with no inertia, it had no resistance to being pulled down except the air and friction. When you shot it up the track, it stopped as soon as the spring quit shoving on it, because without inertia, it had no tendency to remain in motion and air resistance stopped it instantly.

## Planetary Bergenholms

Planetary Bergenholms (TS7) cost \$100 million, consume one million pounds of mass per hour and take 1,000 acres of various ten-story tall structures. They also require Medonian super-conductors and insulation, which remain jealously guarded Patrol military secrets until long after the Boskonian War. A number of such facilities are required, spaced regularly around the planet, one for every  $10^8$  cubic miles of the planet's volume. Thus, to take a typical asteroid (ten miles in radius) free requires only one installation, but taking a Tellus-sized world (4,000 miles radius) free requires over 2,500 such facilities, totalling \$250 thousand million. Note that the stations must be *regularly* spaced and *motionless* to within inches — if this requires one in mid-ocean, there will be additional costs.

The maximum speed a free planet can reach is limited by temperature — friction with interstellar dust and gas heat the planet. If the planet is to remain habitable, it must not exceed 15 parsecs per hour. In no case can the planet exceed 60 parsecs per hour — at that speed its temperature has risen sufficiently to soften the bedrock supporting the Bergenholms.

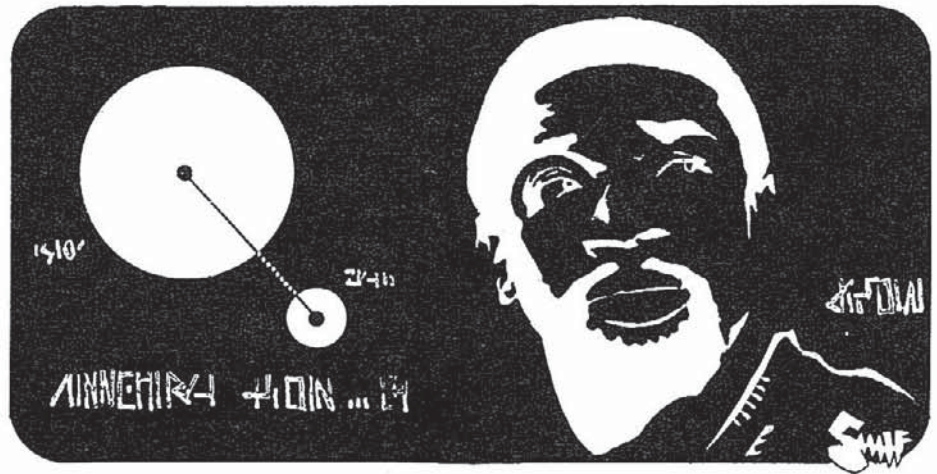

The fortress itself was shielded from the detonation, approximately equal to 62.5 kilotons of TNT, by the blast-wall of the gun mount. The mount itself and its crew were, of course, obliterated.

The duodec explosion, propagating at the speed of light, compressed the beam-rods with a pressure starkly incalculable. The very electrons of the crystalline matrix were forced into the nuclei, forming a degenerate state of matter consisting solely of neutrons. This crystalline condensed matter (or so-called *neutronium*) directed the remaining energy of the explosion outward in a beam so unimaginably tight and hot that it punctured all screens, the very wall-shield and the cruisers themselves *even though they were free at the time*. The slight amount of gas and plasma around the cruisers from the previous battle provided sufficient resistance that this ravaging lance of force could puncture them with ease.

The scientists of Civilization analyzed the reports and were soon able to duplicate the effect and improve upon it. Since the explosive charge is confined in a neocarballoy casing permeated with MKR fields of force and the beam is limited in duration, the weapon mount is not harmed. The cartridge containing the beam-rods and explosive is vaporized, however. The crew is shielded from the lethal back-radiation by force fields and several feet of LOWCAP, a highly secret laminate of lead, osmium, carbon, cadmium and paraffin. All these protective systems require tremendous amounts of power, several million million kilovolt-amps.

On a spaceship, a single projector and its required turret with a Firepower rating of 20,000 masses 100 tons, takes up 30 cy, costs \$100,000, consumes 1 lb./hr., and is operated by a crew of 30. Additional weapons may be mounted in the same turret, each adding another 50 tons, 20 cy, \$25,000, 1 lb./hr. and 10 crew. Firepower may be increased by correspondingly increasing mass, volume, cost and power requirements, and increasing crew by a factor of 1.5 for each factor of 10 increase in Firepower. Thus, each of the eight three-weapon turrets of a *Dauntless*-class dreadnought masses 2,000 tons, fills 700 cy, costs \$1.5 million, consumes 30 lb./hr., and has a 75-being crew. Each individual weapon has a Firepower of 200,000.

A single projector may fire once every thirty seconds. The Thorndyke heavy-duty switches (THDS, pronounced "thuds"), capable as they were, can only handle one projector's firing current at a time. Using THDS, multiple projectors in a single turret cannot salvo faster than 0.69 seconds between shots (0.60 seconds beam duration, plus 0.09 seconds switching interval). Thus a *Dauntless*-class turret can fire all three projectors in just less than two seconds, but would then need thirty seconds to reload. If Medonian switch-gear is used, all projectors can fire simultaneously.

Ship turrets typically hold 120 cartridges per projector, but this number can vary by up to 10% depending on exact turret design. Magazines elsewhere in the ship can hold many more. Each cartridge masses 2,700 pounds and costs \$1,400.

## Sensors and Communications

### Ultra-Wave Communications Suite (TS2)

Ultra-waves propagate below the level of the ether, on the sub-ether, at about 19 million million times the speed of light. They allow almost instantaneous intra-galactic communications, and make inter-galactic communications possible (though the over-thirty-second inherent delay in conversations between the Milky Way and Lundmark's is extremely annoying). In theory, their range is unlimited, though under poor conditions, such as during jamming, one parsec's range may be impossible.

A communications suite that includes both ultra-wave and radio sets with scrambling and encryption circuitry to enhance security costs \$500. Space, weight and power requirements are negligible. The transmitter has two modes of operation: broadcast, which can be received in any direction, and tight-beam, which can (it is supposed) be picked up by only one receiver. Broadcast is trivial for anyone with any Electronics Operation skill to use; tight-beam requires a skill roll to aim correctly. A skilled operator can modify the set to tighten the beam even further, but any bonus to avoid interception is also a penalty to aim.



### Sensor Suite (TS3)

A standard military sensor suite is \$5,000, 15 cy, 10 tons. It includes many different instruments.

"Electros," electromagnetic sensors such as magnetic field and radiation detectors, radar and telescopes, are widely used despite their drawbacks. They are essentially useless at anything but close range (under 100,000 miles) because of the slowness of ether-borne wave propagation, but they are difficult to "spoo" or deceive. Ships can be painted utter black and configured in ways that minimize radar reflections, but if there is any ferrous metal anywhere in the ship, the magnetic detectors will find it. If an atomic pile is in use, the radiation detectors will pick up its leakage. Ultimately, there is no way to prevent a telescope from noticing that stars are being occulted.

*Ultra-wave tracers* can detect an ultra-wave beam and determine its orientation — where it is going and what way it came from. The exact effectiveness of the tracer is subject to many factors including how tightly focused the beam is, how powerful the transmitter is, how far the tracer is from the transmitter, how far it is from the beam itself and so on. "Gamma-zeta," one of the best military models, can analyze even the tightest transmissions that pass within several thousand miles of the tracer.

A confusion of terminology exists, in that devices to track a physical object are also called *tracers*. These tracers are very light tractor beams, with ranges greatly extended by one of several techniques. Once locked onto a target, bearing and range can be easily measured from the orientation and strength of the beam.

*Corpuscle resonance transduction* (CRX) is one technique by which a tracer can be extended to interstellar ranges if its target is Bergenholm-propelled. While Bergenholms are tuned to emit the vast majority of their energy as fourth-order corpuscles, some harmonic leakage is inevitable. A properly tuned transducer can heterodyne on those higher-order harmonics and so can greatly multiply its strength. The total force added by this technique is measured in the microdynes, which makes it useless for short-range tracers but which is enough to determine a bearing.

### Assault on Helmuth

Admiral Haynes' voice droned from the JV speaker. "Now, remember, boys, keep your hands off of those keys until I give you the word."

Able Spaceman (Beamer's Mate Striker) Dave Empey nervously scanned the dials and gauges of the projector's control panel. He knew the drill well enough, had sat in the gunner's nest often enough during checkouts, had even vaporized a pair of meteors, but he hadn't expected to sit Beaman so soon!

Haynes' voice continued without pause, in flat tones intended to soothe that actually tightened nerves until they twanged. "I'll give you lots of warning . . . I am going to count the last five seconds for you."

His panel showed everything QX — except for one angry red circle. He glanced up at the gun captain, sitting on the open access cover of the projector, who grinned and shook his head. As if Dave would fire before ordered! He twisted on the metal seat and touched the verniers. The coordinates hadn't changed in the last three-quarters of a second.

"I know that you all want to shoot the first bolt, but remember that I personally will strangle any and every one of you who beats my signal by a thousandth of a second."

He didn't doubt that one iota. The Old Man's Lens was a mere formality; everyone knew he could easily read minds and see everywhere in the great dreadnought without it.

"It won't be long now, the second hand is starting around on its last lap . . . Keep your hands off of those keys . . . keep away from them, I tell you, or I'll smack you down . . . fifteen seconds yet . . ."

The red circle was replaced by a green bar and he heard a clank as the petty stood up. The cover flipped shut and locked.

"Stay away, boys, let 'em alone . . ."

His hand hovered over the firing key, worn smooth and dark red by a myriad blows.

"I'm going to start counting now. Five — four — three — two — one — FIRE!"

Empey slapped the key into its lowest detent, and the main projector's beam roared out, a ravaging quasi-solid bar of pure force that wreaked utterly indescribable havoc on Helmuth's Grand Base.



### **Missiles and Shells (TS0)**

The use of dirigible missiles and unguided rocket-driven shells in space combat ended abruptly with the invention of the Bergenholm inertialess drive. It is possible (though expensive) to put a Bergenholm in a missile, so that it can maneuver as well as a free ship. However, an operator to guide the missile is still required, and the missile would also have to be equipped with a tractor and a beam weapon, since explosions are harmless to an inertialess ship. One technique developed during the Jovian Wars, that of penetrating the enemy's screens with a hollow tube of force and firing a shell down that tube, was briefly revived for a special mission (Operation QBT, well-discussed in many other publications), but it was rendered finally and completely obsolete by the invention of tractor shears.

Missiles tubes cost \$500-\$2,000 each, mass 1-4 tons and take up 3-6 cy. Missiles themselves cost \$200-\$7,000 each, mass 1-3 tons and take up 1 to 10 cy. Guns cost \$5,000-\$20,000, mass 5-40 tons and take up 10-1,000 cy. Their shells cost anywhere up to \$1,000 and mass anything up to one ton. Both missiles and shells have firepowers of 1-100 *against inert targets only*.

Like the ultra-wave tracer, a physical tracer's effective range is dependent on many factors, including the rating of the Bergenholm it is tracking, the skill of the technician who last worked on that Bergenholm and the number of other Bergenholms operating near the tracer.

### **Indetectability Suite (TS6)**

This is a collection of devices throughout the ship, from refractory baffles over the driving jets to light-absorbent paint to non-ferrous equipment to special subetheric interference generators, or "detector-nullifiers," that make it harder to detect the ship that carries them. An indetectability suite is denoted "-1" if it subtracts 1 from sensor rolls, and so on.

An indetectability suite is three levels *more* effective for each TS by which it exceeds the TS of the sensors, and not effective at all against sensors of a superior TS.

Cost, mass and size of an indetectability suite don't depend on TS, because the sensors to be defeated are constantly improving, too. They do depend on the size of the vessel to be concealed. The detector-nullifier itself has negligible mass and volume (indeed, early models would fit in a shirt pocket), but the flare baffles and special non-ferrous equipment are still significant. For each 1000 tons of ship mass, a -1 suite costs \$100, takes three cy, masses 1 ton, and reduces maximum ship's speed by 10%. Each additional -1 of suite effectiveness doubles cost, mass and size and reduces speed by another 10% of full, up to a maximum -6.

### **Nullifier-Scramblers (TS7)**

Large ships and planetary installations can install field generators that interfere with detector-nullifiers. They are large and expensive; 5 tons, 10 cy, \$5,000 and pound per hour of power will lower the effectiveness of an indetectability suite within 100 miles by 1 point. Larger generators increase both range and effectiveness, but cost, mass and volume double for each additional point *or* additional 100 miles of range.

### **Etheric and Sub-Etheric Jammers (TS2)**

When it is important that no intelligible signals are sent from or received in a particular volume, jammers are used to fill the ether and sub-ether with howling static. A jammer that gives all sensor suites within 1,000 miles a -3 penalty costs \$100,000, masses 1.5 tons, takes up 100 cy and consumes 1 lb./hr.. Each additional -1 rating adds \$10,000 and 1 lb./hr..

A jammer requires a long action (for duration of operation) by a crewman with Electronics Operations/Sensors. No rolls are required, but using it is a combat action. A jammer can also attempt to jam a particular sensor suite rather than an entire area. Treat this as a quick Contest of Skills between the jamming equipment's operator and the sensor operator, modified by the ratings of both systems, with ties going to the jammer.

Jammers and indetectability cannot be used at the same time.

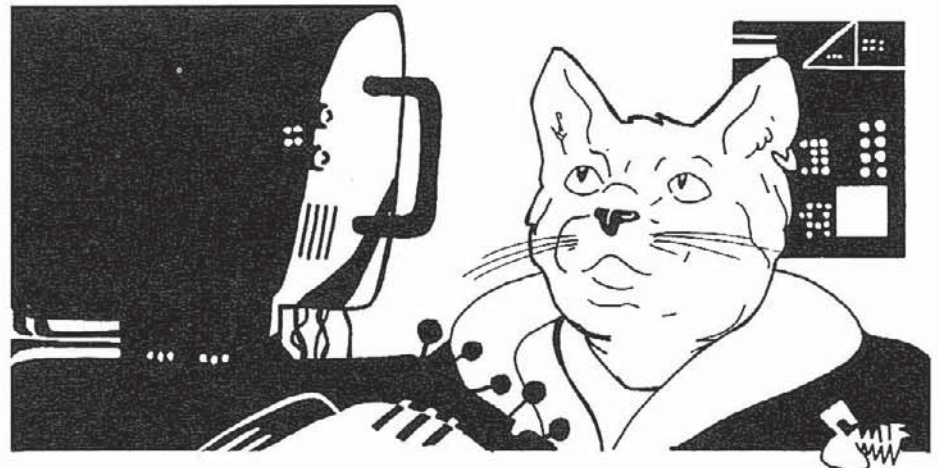

## **Display Tanks (TS2)**

While every pilot room down to the smallest one-man yacht from the earliest days of space travel has had a display tank, a minutely detailed three-dimensional representation of surrounding space, it was not until the assaults on Jalte's planet and Jarnevon that it reached the pinnacle of its development. The Z9M9Z, or *Directrix*, had a tank 700 feet in diameter and 80 feet thick in the middle, for a total volume of three-quarters of a million cubic yards. It is impossible for a mind limited to vision to comprehend the detail of such a huge tank, but hand-held Simplex analyzers can be used to identify and provide information on any individual symbol in the tank.

Display tanks ten cubic yards or greater in volume cost \$25 per cy and \$100 per Simplex, but tanks that large are needed only by those directing fleet actions. The typical tank used by a ship of the line is \$1,000 and 1 cy and has three Simplexes. A privately owned ship's tank costs \$20 per cubic foot (27 cubic feet to the cubic yard) and has only one Simplex.

At TS0 and 1 the tank was known as the "ball" — an electronic, hemispheric visiscreen first used in the rocket ships of the Technos of North America during the Tellurian World War.

## **Gravity and Inertia Technology**

### **Artificial Gravity (TS3) and Pseudoinertia Generators (TS4)**

Pseudoinertia and artificial gravity generators (which also function as grav compensators) serve up to 1,000 cy of volume. If multiple units are required, they must be located in the appropriate areas; thus, one hit won't take out all of a big ship's gravity. (It is not necessary to supply artificial gravity and pseudoinertia to the entire ship — many freighters have neither in their holds.) Each unit costs \$10,000, masses 15 tons, takes up 10 cy, and draws 1 lb./hr. of power. A unit can provide any *minimum* from microgravity to three Gs; during inert maneuvering the actual acceleration of the ship divided by 100 is felt instead, if that value is greater than the generator's setting. The generators cannot compensate rapidly enough to protect against lurches, so inert maneuvering, when the pseudoinertia generators are not active, can be rough.

### **Tractor Beams (TS3)**

These beams pull their target to the beam generator, and vice versa. They are used for a wide variety of purposes, such as cargo handling, fine maneuvering and grappling in combat. Use of even one tractor beam gives a +1 to Piloting skill for a microgravity or zero-G rendezvous.

The effect of a critical failure on any tractor beam use varies with the use. Most tractor beam mounts are reinforced to support the full weight of the ship under heavy acceleration, so it would be difficult (but hardly impossible) to tear the beam generator out of its mounting. If neither the beaming installation nor the grappled object mount screens, a collision is likely.

Beams come in all sizes, measured in kilotons. A 1-kiloton beam gives the equivalent of 1 kiloton of thrust; *e.g.*, it can pick up a 1,000-ton object (close by) under 1 gravity. However, the beams are not long-range — effective strength is halved every ten miles. A tractor beam occupies 2 cy and 1 ton per kiloton of pull. Cost is \$500, plus \$20 per kiloton of pull. Fractional strengths are possible; divide cost and weight appropriately.

Tractor Beam Operation is a professional skill (Physical/Easy), defaulting to Gunner (any beam weapon)-2 or DX-4. A roll is required to hit the intended target; modifiers are the same as for any Gunnery. Once a beam hits a target, it will remain locked to that target with no further attention until released, cut or the target pulls out of range.

### **Pressor Beams (TS3)**

Pressor beams (sometimes called repellers) are exactly like tractor beams, except that they work in reverse, pushing instead of pulling, and they cannot be cut. They are the same cost and weight as a tractor.

## **The Rescue of Medon**

The new primary beam turrets' main control panels made the earlier projectors — secondaries, they were now called — look as simple as a light switch to operate. Beamer's Mate Third Class Empey had been checked out in the turret, but had never actually shot it. Security risk, Klono's tin toenails. He didn't get it; what good was a weapon you couldn't use?

But now it looked as though he would be the first to shoot the new mounts at a foe. A sullen red HOLD lamp glowed from his panel, and flickers of yellow came from the automatic verniers as the gun wavered. That lamp wouldn't go out until Chatty — Mr. Chatway, the Chief Firing Officer, up on the bridge — gave the order to fire, and for a CFO, he was sure reluctant to use his ship's weapons. The flickers would continue as long as Hairy Henderson, also up on the bridge, kept putting the massive ship through these gyrations, and that would be forever. The fire designator was tracking his targets and feeding them to his station, but it was his job as Beaman to manually stabilize and shoot the huge guns.

"Stand by to engage designated targets," came the simple order.

Where was that pedal; he couldn't find the Klono-biting pedal . . . !

"Fire as you bear!"

Dave kicked the firing pedal and the primary beam shrieked forth, an irresistibly penetrant stiletto that even a Q-type helix of force could not withstand. Dave snapped the gun selector to the second position, and as the turret slewed the second ship filled the reticle. He touched two verniers — the Boskonian had moved nearly half a ship-length since the last bearing had been taken. The reverberations from the first shot were still ringing off the turret bulkheads when he stomped the firing pedal again. The shriek of the second beam was much quieter to deafened ears, and Dave snapped the selector to the third position. The Boskonian swam into the reticle . . . a riddled hulk, already sliced nearly in half by Turret #3.

"Cease fire!" came the order and the HOLD lamp flashed red.

The ringing echoes of the beams were punctuated by twin crashes as the guns' breech-blocks hit their back-stops, hurled by tons of hydraulic pressure. The clangor of the spent shells being ejected and new ones rammed home continued for another half a minute, but the Battle of Medon was long over. Two and one-tenth seconds had elapsed.



### ***The Z9M9Z at the Battle of Midway***

Long after World War II, Doc Smith received a letter from John W. Campbell (the editor of *Astounding* magazine, where much of the Lensman series was originally published). In it, Campbell relayed Admiral Nimitz's acknowledgment that he had used Smith's display tank ideas in the design of the US Navy's ships' Combat Information Centers.

"Your entire set-up was taken specifically, directly, and consciously from the 'Directrix' in your story. Here you reached the situation the Navy found itself in — more communication channels than integration techniques to handle them. In your writing you proposed precisely such an integrating technique and proved how advantageous it could be."

Tractors and pressors are an integral part of the Chung (so-called "tensegrity") doctrine of space strategy, used to link massive formations of ships of the line into integral structures.

The most efficient smaller pressors use the De Broglie duo-pentode ("D2P") design.

### ***Tractor Shears (TS3)***

A tractor shear is a modified pressor that is targeted at the enemy's tractor beam, and sets up an interference pattern which breaks the tractor's grip. The shear does not need to be held on the tractor; even momentary interference is sufficient to cut the beam. The tractor operator may immediately attempt to re-establish a lock, but he must begin anew.

A Gunnery roll is required for the shear to hit the tractor beam. Add to the roll the difference in capacities between the shear and the tractor (a shear with a capacity of 8 kilotons trying to cut a 10-kiloton tractor is at -2, 15 kilotons cutting 10 is +5). All standard Gunnery modifiers also apply. Since the tractor and the shear trying to cut it are already locked together, the range is probably quite close, and the target is not moving, relative to the shear.

Tractor shears' weight, cost and so on are identical to pressors, above, but they cannot be used for anything but cutting tractors.

### ***Tractor Zones (TS8)***

Immediately upon the invention of the tractor shear (above), the scientists of the Patrol began development of the "uncuttable" tractor. What they devised was a biphasic version of the meteor screen, a globular shell of force that absorbed all momentum imparted to it and transferred it to the projector and its mounts. While a meteor screen only affects incoming matter, the tractor zone works in both directions.

The tractor zone is formed uniformly around its generator. All matter contacting its spherical shell of force loses all radial momentum, and stops moving inward or outward. (Any angular momentum remains, and the matter slides around the shell.) Tractor shears, designed to interfere with beams, have no effect on this area of force.

The target's radial momentum is transferred directly to the mounts of the projector, so those mounts must be constructed to withstand the most violent inert impulses the target can impose, or major damage will result.

Since tractor zones are formed at a specific distance from their projectors and then tightened, their capacity is measured in miles of range as well as tons of pull. Tractor zone projectors weigh 1 ton, occupy 10 cy, consume 2 lb./hr. and cost \$1,000 per kiloton of pull and per mile of range.



# WEAPONS OF MASS DESTRUCTION

## Demolitions

Explosives have Relative Explosive Force values that express their destructive ability as compared to TNT, which has an arbitrary explosive force of 1 and does 6d×2 damage. For example, black powder (REF of 0.5) does just half the damage that TNT does, or 6d damage per pound.

### Cyclonite (TS0)

Cyclonite is used during the final phase of the Tellurian World War, and for many years thereafter was the high explosive of choice. It is still in use until advances in sub-etheric chemistry make duodec possible. It has a REF of ten.

### Duodecaplylatomate (TS5)

Duodecaplylatomate, or "duodec," is the concentrated quintessence of atomic violence. Its detonation propagates at the speed of light, which makes it the ultimate high explosive, with great shattering effect. Its detonation pressure and temperature have never been measured save indirectly, since nothing will hold it except a Q-type helix of pure force. It has a REF of one million.

### Heptadetonite (TS1)

Heptadetonite is a low explosive used throughout Civilization for peaceful purposes such as earth-moving, and by military forces as a propellant. It has many good qualities, such as ease of manufacture, and stability under shock and temperature extremes. It has a REF of 1.5.

### Ferral Paste (TS1)

Successor to thermite, ferral paste is a thick, sticky gel commonly stored in cans and applied with a non-metallic trowel. It can be ignited with either open flame or electrical shock, and it burns with a characteristic brilliant scintillation at 7,082.3° F. It will burn through a standard interior partition of a ship in less than a second, through a pressure bulkhead in about two-and-a-half seconds, and through a standard ship's hull in about fifteen seconds. It contains its own oxidizer, so it will burn underwater or in vacuum.

## Chemical Weapons

### Vee-Two Gas (TS1)

The nerve toxin V2 (Vee-Two) is a breath agent; it is not absorbed through the skin except in high concentrations. A very small concentration in the lungs, however, nearly instantaneously causes complete relaxed paralysis of every voluntary muscle in the body. The symptoms are obvious: a rasping catch in the breath as the diaphragm relaxes, widely dilated pupils, and a completely limp body. A victim remains fully conscious and aware, but has great difficulty breathing.

The effects are not immediately permanent; if forced respiration clears the gas from a victim's lungs within the first ten minutes, muscular control will be regained. Within an hour, an antidote is required. If more than an hour has passed between the exposure and the administration of the antidote, a HT roll must be made, minus the number of minutes over an hour. If this roll is failed, the victim's voluntary nervous system has completely failed, and he will never regain muscle control.

After TS7, Phillips regeneration (p. 83) can heal a Vee-Two victim.

### VXN Gas (TS1)

VXN is another chemical warfare agent; it attacks the central nervous system and induces a state of euphoric hypnosis. Anyone breathing it has Will reduced by 3d. If Will drops below 3, the victim will not move without direct orders and encouragement. The effects last for five minutes, then Will begins returning at 1 point per minute until all is restored. Some people exposed to VXN enjoy its effects so much that they develop addictions to barbiturates or bentlam.

## Brute-Force Inerting: The "Net"

It is possible to go inert on the surface of a planet and survive the experience — with proper preparation. *The net* is a sack of canvas and leather padded with sponge rubber and coiled steel, anchored by the best shock-absorbing mechanisms ever devised to the walls, floor and ceiling of a cubical concrete bunker seventy feet long, wide and high.

However, not even *the net* can absorb more than a tiny fraction of the prodigious kinetic energy that is rapidly accumulated as Tellus rotates. Simply waiting twelve hours causes well over half a mile *per second* difference in intrinsic between the surface of Tellus and a free body. Delta-V that high is far beyond the capabilities of *the net*. Only those who have gone free at *the net's* location and no more than half an hour before have any chance to survive. If less than ten minutes have elapsed, a person can hope to leave *the net* undamaged, but beyond that time, the required acceleration becomes hellish.

Minutes less than 10	Free Gs less than 2	HT roll None
10-11	3	HT+4
12-13	4	HT+3
14-15	5	HT+2
16-17	6	HT
18	7	HT-2
19	8	HT-4
20	9	HT-6

And so on . . . another G and another -2 to the HT roll for each minute more up to half an hour. The rate increases; after one hour, the required deceleration is 73 Gs, and after 12 it is 4,300 Gs.

If the HT roll is failed, the character has sustained some damage. Roll 2 dice and add the G-force.

- 5 — Unconscious 2d secs.
- 6 — Unconscious 4d secs.
- 7 — Unconscious 6d secs.
- 8 — Unconscious 8d secs.
- 9 — Unconscious 10d secs.
- 10-11 — Unc. 10d secs, 1d-3 damage.
- 12-13 — Unc. 10d secs, 1d-2 damage.
- 14-15 — Unc. 10d secs, 1d-1 damage.
- 16 — Unc. 10d secs, 1d damage.
- 17 — Unc. 10d secs, 1d+1 damage.
- 18+ — Unc. 10d secs, 1d+2 damage.

Larger *nets* have been built, but the problem of intrinsic velocity is fundamental enough that there is no real change in the idea of *the net* since the beginning of the Boskonian War. Larger *nets* reduce the acceleration proportionally; *i.e.*, one 140 feet on a side would halve the above numbers.

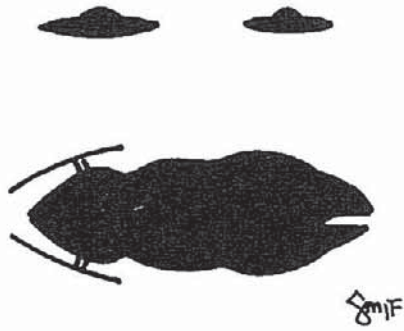

## Beams of Force

Force-beam technology is well-developed in both Civilization and Boskonian. The large number of manufacturers of force-beam devices all use different numbering schemes, resulting in a plethora of cryptic designations. A random sampling includes:

- C4V63L29: An ultra-band pressor beam.
- CRX: A tracer beam.
- D2P: A pressor beam.
- D7M29Z: A thought screen.
- gamma-zeta: A communications beam detector.
- KJ42: A "hot shot" heat generator.
- K4: A red-colored field used for visual ship-to-ship signals.
- K6T: (similar to K4).
- LSV3: The tightest communication ultra-beam.
- Q47SM9: One of many Q-type helices of force.
- R7TX7M: A spy-ray detector.
- SX7: An early type of macro beam.
- TX7: A spy-ray.

## Annihilation of a Planet

The total energy  $E$  required to completely disrupt a uniform spherical body of mass  $M$  and radius  $R$  is equal to  $0.6G M^2/R$ , where  $G$  is Newton's gravitational constant,  $6.673 \times 10^{-11} \text{ N m}^2/\text{kg}^2$ . Thus, to reduce Tellus ( $M=5.974 \times 10^{24} \text{ kg}$  or  $1.314 \times 10^{25} \text{ lbs.}$  and  $R=6,378 \text{ km}$  or  $3,827 \text{ miles}$ ) to asteroids would require  $2.24 \times 10^{32}$  joules or 2.73 million million tons of total conversion. Note that this energy must be efficiently applied — simply bombarding the surface with superatomic bombs yielding 53 thousand million teratons of TNT would be insufficient.

## Inert Collisions

An inert high-speed collision can do damage without any explosive being involved. One ton of matter traveling at one mile per second does as much damage, to itself and to what it hits, as 600 lbs. of TNT (or  $6d \times 1,200$  points). This energy goes up proportionally with mass and with the square of the velocity, so a 1,000 ton ship traveling at ten miles per second does as much damage as a 30 kiloton atomic explosion (without the radiation effects, of course). Weapons that rely solely on their velocity to do damage are known as *kinetic kill* projectiles.

## Planets (TS7)

An extreme example of a kinetic kill weapon is an entire planet, inerted so that its intrinsic velocity causes it to collide with the enemy.

At the Battle of Jarnevon, that planet was crushed between two others, massing some six thousand million million million tons each and chosen to have opposing intrinsic velocities totalling some 60 miles per second. When they struck Jarnevon, the kinetic energy alone was approximately equivalent to 13 million million teratons of TNT. (The internal energies of the planets' mantles and core also contributed significantly, of course.)

This annihilant power was deemed sufficient for most threats. It is difficult to defend against inert planets. Aiming another dirigible planet to collide with the enemy's is awkward, slow and unreliable. Even a sunbeam (below) takes several seconds to destroy one . . . and when it does, most of the planet's mass is still moving in exactly the same direction and is now hotter. A free planet can be intercepted before it can be moved into position, and its planetary Bergenholms attacked. Damage to even one of the thousands of stations around the planet will render it inert, moving in an unintended direction. In turn, the most straightforward way to minimize this countermeasure's effectiveness is to use planets with higher intrinsic velocities, relative to the target, so there is less time to attack the Bergenholms.

The ultimate physical weapons ever employed were planets from another universe, chosen with intrinsic velocities some 15 times greater than the speed of light in our universe. Such a velocity is starkly impossible, of course, implying as it does *imaginary* lengths, times and masses (and therefore *imaginary* energies, momenta and similar derived quantities). There was some speculation that at the instant of inerting such a mass, all matter in our universe would coalesce with it in zero time. Fortunately, that did not occur. Unfortunately (from a scientific point of view), the instruments present were entirely unable to measure anything about the event. No meaningful observations were possible and it has never been repeated, so *actual* effects remain in the realm of speculation. The Guardians of Civilization have indicated that intellectual stability at a minimum of the second level of stress is required, so further discussion here is inappropriate.



## Negaspheres (TS7)

With the availability of Medonian superconductors it became practical to synthesize contra-terrene matter in quantity.

Contact between a negasphere and normal matter also creates ravaging actinic radiation of unimaginable intensity. An unprotected human 500 miles from the mutual annihilation of one pound of negative matter with one pound of positive

matter receives 5,000 rads, and dies quickly of complete cerebro-vascular collapse. The dosage goes up proportionally with the mass annihilated, and down with the square of the distance. The intersection of a planet and a negasphere of planetary anti-mass will produce lethal dosages at a range of some hundreds of parsecs.



## Sunbeams (TS8)

It is possible to construct a virtual vacuum tube from a stellar system. The sun is used as the emitter, and countless thousands of installations throughout the system serve as grids and plates, aiming the plasma beam. For a star similar to Sol, the beam carries an energy of over four million tons converted per second. Note that *two* beams must be created, one positively charged and the other negative; they must be aimed in exactly opposite directions, or thrust will be exerted on the star.

It is difficult to shield against such energies, although the diameter of a large planet will provide protection for some time. Roll 1d for every thousand million million tons of the planet's mass to determine how many seconds before the planet begins actually breaking up, ending the protection. Thus a Tellus-like planet will protect a facility on the far side for 6d seconds, while a Jovian planet will last 32d minutes. Of course, such an installation will have been constructed to withstand the instantaneous onslaught of seismic quakes of inconceivable magnitude, the starkly hypersonic winds and similar design challenges.

A sunbeam is expensive to construct. The sun/emitter must be closely surrounded by 12 stations (arranged at the vertices of a dodecahedron), each of which cost over a hundred billion credits when the solar sunbeam was constructed. Then grid/plate generators must be placed in every direction that the beam will be used. These cost roughly a billion credits each. (In the solar system, the asteroid belt proved convenient for the several thousand that were constructed.)

Activating the sunbeam is not difficult. Controlling it is. Two rolls are required *every second*, one at the average skill of the operators at the emitter stations to activate the beam, and one at the average skill of the appropriate grid and plate operators to aim it.

The minimum skill (Professional Skill: Sunbeam Operation, Mental/Very Hard) required of the emitter sunbeam operators by the Galactic Patrol is 15, and the average is 18. The minimum skill (Gunner (Sunbeam)) required of the grid/plate operators is 12, and the average is 15.

If the second, aiming, roll is missed, the beam wanders and missed the desired target. The GM will determine exactly where the beam went. If anything of concern is near the target, such as a friendly space-fleet, it may be hit by mistake. Note that even if the beam hits something, only part of it will be blocked, and that not for long. The beam continues far out to interstellar space before diffusing enough to be harmless.

If the activation roll succeeds, the star dims dramatically and the beam is produced. On failure of the activation roll, however, the star flares wildly, and every planet in that stellar system suffers a year (cumulative) of exceedingly strange weather. On critical failure, the star becomes permanently variable, which will quickly render all but the most adaptable life in that system extinct. If the star was already variable (possibly from a previous critical failure) and a critical failure occurs, roll 2d. In that many days, the star will go supernova, eliminating its system and becoming a navigational hazard to shipping in that sector.

## A Note on "Free" Combat

Inertialessness has a tremendous effect on hand-to-hand combat. All weapons that exert force on their target — such as beams, bullets, bladed weapons and explosives — are useless. A moving object will instantly stop when it strikes anything else. Compressed gasses will not expand if they are restricted in any way — shells will not be pushed down gun barrels.

The only way to damage a target is to link it and the weapon together and apply direct pressure. Swinging a space-axe does not build up momentum; the axe is massless and so its velocity is irrelevant. However, it is still sharp, and can be *pushed* into a foe, if he is somehow prevented from moving away.

Before any attack while inertialess, a player may describe *how* his character is attacking, and the GM will decide what skill rolls are necessary (or will simply describe the failure, if such is automatic). Alternately, a player can roll against his Inertialess Agility skill. If successful, he can attack; a failed roll means no effective action that turn.

*Example:* The pirate was obviously unused to fighting free. He snatched the semi-portable off of its tripod, delighted that he could swing the huge weapon around with ease. With twenty-seven years of combat experience in all environments — weightless, free, both or neither — Gunn'y Sergeant "Lifer" Bennett grinned as he leapt forward, knowing what would come next. The Boskonian pulled the trigger. Within the big firearm, the sear released the hammer, and a powerful spring drove the massless hammer forward at starkly incredible speed, until it struck the equally massless firing pin. The pin moved forward, not because of the thick hammer's momentum, for it had none. The hammer spring still exerted a slight force. The pin touched the base of the 100-caliber shell's primer . . . and stopped.

The pirate's glee became bafflement . . . and then Bennett grabbed him. Ignoring the full-muscled blows, infinitely lighter than a kitten's swipes, he seized the pirate's neck with his left arm in an unbreakable lock, and drove his right arm forward. Space-axes have a long, needle-forged spike at the top of their shafts. Bennett's thrust wasn't particularly fast, but he pushed *hard*. The beryllium-carballoy spike slipped through the tough material of the space suit and through the far softer tissues of the Boskonian.

Inertialess blood doesn't spray wildly. It wells out. When also weightless, it hangs in a single large sphere outside the wound.



## ◎ WEAPONS OF INDIVIDUAL DESTRUCTION

### DeLameters (TS5)

Some weapons become immortal. On Tellus, Colt's Patent Fire-Arms Manufacturing Company was established in 1836 and produced weapons for well over two centuries. The most successful firearm of all time, the Colt .45 ACP auto-loading pistol, went on sale in 1905, and was in use a century after the Third Phase of the World War, falling from popularity only after beam weapons became common. A single company has surpassed Colt's fame and success. DeLameter Beam Weapons, Pty. has produced many models of beam weapons since the early years of the Triplanetary League, including, like Colt in its time, the definitive hand beamer, *the DeLameter*.

A DeLameter has three settings: Tight, Normal, and Fan.

*Tight* setting is designed for use against heavy armor. The beam is pencil-thin and does not spread. It does up to 5d×2(5) impaling and follows the blow-through rules for bullets on page B109. (The number in parentheses refers to the DeLameter's ability to penetrate armor — divide the DR of the target by 5 before applying damage. For more information, see *GURPS Ultra-Tech*, p. 125.) A Tight shot counts as 3 shots for power consumption purposes.

*Normal* setting is intended for use against light protection (normal spacesuits, low-tech armor). The beam spreads to a diameter of six inches at ten yards, doing up to 5d×4 impaling and using the beam blow-through rules. A DeLameter can fire 20 Normal blasts before draining its C cell.

*Fan*, for use against soft targets, does up to 5d×2(½) impaling, and does not blow-through. Fan shots count as quarter-shots for power consumption purposes.

On any setting, the firer may choose to reduce the number of dice of damage rolled before any shot, to conserve power. Thus, a Normal shot that only does 5d damage counts as one quarter of a shot.

### Worsel-Thorndyke Molecular Disruptor (TS8)

"[T]hought, in any organic being, is and must be connected with one definite organic compound . . . a large molecule, one of very high molecular weight. Thus it is comparatively unstable. A vibration at the resonant frequency of any one of its component groups would break it down, and thought would therefore cease."

With the availability of Medonian super-conductors and -insulators, such a generator can be made extremely small — less than an ounce, powered by a AA cell. It could easily be built into a piece of jewelry, for example. It is activated by thought and has a range of several hundred yards. It is blocked by any thought screen or Mind Shield of Power 50 or greater.

All data concerning the thought-molecule is highly secret, as is the death-ray's existence and design. Only one was ever actually built. Gray Lensmen with an extreme need to know would be able to obtain information on it; any others even hinting about the subject would be *very* thoroughly investigated and debriefed.

### Spybeam (TS2)

Not only does matter affect the space-time continuum (popularly called the "ether") in which it resides, but it also distorts the harmonic spaces "above" and "below" it. A properly designed ultra-wave set can detect such resonances and translate and display them. A "spy-beam" is such a device, analogous in some ways to radar. It emits ultra-wave pulses in a beam focused on a particular area, and uses the returned echoes to display an image of what is in the area of the focus. Sophisticated models can even detect the movements of the atmosphere in the target area and reproduce them, giving sound as well as sight.

Spy-beams can be extremely compact — small enough to fit in not-too-ostentatious jewelry. A spy-beam with a mile's range weighs an ounce, is powered by a AA cell for a year of continuous use and costs \$60.

Spy-beams are completely blocked by any force-shield.

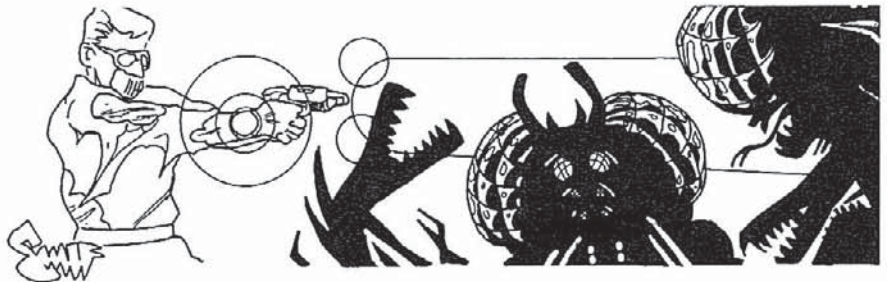

### Lewistons (TS1)

The Lewiston Firearms Company is second only to DeLameter in popularity and first in the longevity of their hand weapons. Despite their name, they do make beam weapons, though their fame comes from their line of slug-throwers.

The Mark Five Lewiston is an auto-loading pistol. It is small (+1 to Holdout) and light but has good stopping power and ammunition capacity. In its day, it was a favorite police and espionage weapon and is still one of the most popular backup weapons made.

The Mark Seventeen Lewiston is the company's first model of blaster. It is large (-2 to Holdout) and difficult to aim well. Military forces use it more than civilians, since it is most appropriate when it is permissible to kill a few dozen innocent bystanders.

The Mark Twenty-Three Lewiston is considered by many weapon enthusiasts to be the finest hand weapon available to private citizens. It uses an extremely safe, reliable and accurate binary propellant system in which the bullet, the propellant and the oxidizer are all stored apart from one another, through in the same magazine. When a bullet is chambered, precisely metered amounts of the liquid propellant and oxidizer are sprayed into the combustion chamber behind the slug. When the trigger button is pressed, an electrical arc ignites the fuel. An A cell will power the ignition system for several years.

## **Nevian Paralysis Projector (TS3)**

The “P-gun” is a hand-held projector of the paralysis developed by the Nevians. One application will only affect portions of a human’s body — one shot will cripple a single limb. It is bulky, short-range and consumes a great deal of power. It is also highly illegal throughout Civilization.

## **Standish (TS2)**

“Semi-portable” is a general classification for any weapon that requires a fixed mount, but that does not require a vehicle to move. Some of these weapons have integral shields, physical or force or both. Many have such high recoils that they must be attached to the ground or deck. Those intended for shipboard use have magnetic clamps for this purpose.

A classic example of a semi-portable is the Standish, an attempt to combine a beam weapon, a 27mm grenade launcher and a force screen. The result is “portable” only in the military sense of that term: it has a handle welded to it. It is a squat, heavy monstrosity with a huge rifled barrel and a heavy beam tube resembling a thick, short telescope. Its magazine holds 6 explosive shells, each costing \$2.50 and weighing over a pound.

The two modes of fire are controlled by separate triggers. A mechanical interlock prevents grenade launching while the beam is active, since the beam would detonate the grenade as soon as it left the gun’s muzzle.

A Standish’s physical barbican provides DR 100 against all attacks from the front, while its force shield has a DR of 300 (against beams — 150 against fast-moving physical attacks such as bullets and shells and none against slower objects like space-axes).

## **Space-Axe (TS1)**

The space-axe is “a combination and sublimation of battle-axe, mace, bludgeon, and lumberman’s picaroon, a massively needle-pointed implement of potentialities limited only by the physical strength and bodily agility of its wielder.” It is used against space armor because the resistance of armor’s “defensive fields var[y] directly as the cube of the velocity of any material projectile encountering them.”

A space-axe’s damage is based on swinging, and it can impale, cut or crush. The type of damage must be specified before rolling the swing, but an experienced axe-wielder takes no time to change his grip from one mode to another. The impaling spike has a armor divisor of 2 (5 for the dureum model), but neither the cutting blade and the crushing club head have any such bonuses.

Space-axes are available in two models: standard and Valerian, and two materials: steel and dureum. The dureum models are smaller and weigh much less, but have far greater inertia.

## **● PERSONAL ARMOR**

A wide variety of armored suits are available for different purposes, but only a small sample can be described here. Note that the exact military nomenclature is given here; in practice, nearly all form of armor issued by the Galactic Patrol are called “G-P armor.”

### **Armor, Space (Light) — GP48 (TS2)**

The standard armor of the Galactic Patrol is not intended to see heavy combat. It is a flexible, insulated pressure suit designed to protect against vacuum, poisonous atmospheres and flying debris or shrapnel. It covers the entire body, with a rigid helmet, giving PD 3, DR 10.

It has exterior pockets, straps, hooks, etc. for equipment, and a short range communicator. Its gloves reduce DX by 1 and its helmet cuts hearing by 2 in air. A back-or chest-mounted life-support system provides heat or cooling and air, for one day, powered by a C cell.

It weighs 40 lbs., costs \$100, and takes five minutes to don or remove.

## **Hand Thruster (TS0)**

This hand-held unit for use in free fall propels the user with bursts of compressed nitrogen. Each burst accelerates or decelerates a normal-mass human at 1 hex/turn in the direction opposite to that in which the thruster is pointed. A successful Free Fall or Vacc Suit roll is necessary to point the thruster in the desired direction. The unit’s compressed-nitrogen cylinder is good for 30 1-second bursts. \$5, 4 lbs. including cylinder; extra cylinders cost \$1, weigh 1 lb., and take 5 seconds to replace.

## **Magnetic Boots (TS0)**

More like heavy sandals than boots, these handy devices let the wearer walk along bulkheads or on space ship hulls in microgravity or free fall, at regular Move if the character has Vacc Suit skill, at ½ Move if not. There are two types; one sort is fitted like shoes for inside wear and the other fits onto any vacc suit. It takes ten seconds per boot to put them on, five to take off. \$10, 2 lbs./pair. Magnetized plates may be built onto the soles of any rigid suit’s boots at an additional \$10 and ½ lb.

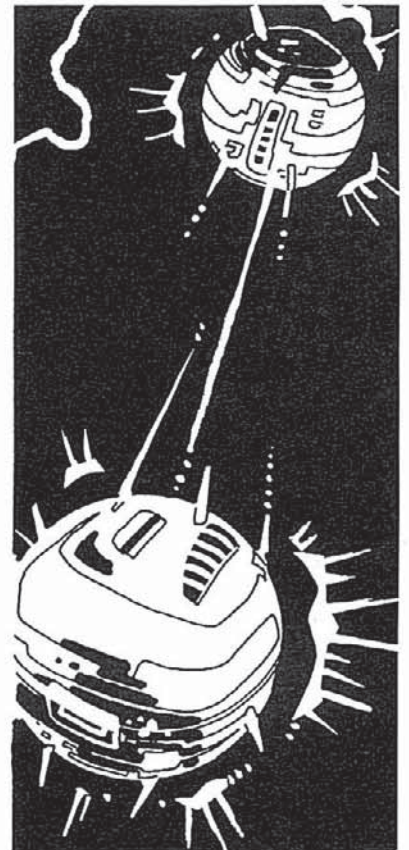

## Power Cells

There are six sizes of power cells, designated by letter from AA (the smallest) to E (the largest). Power cells increase in power exponentially. An A cell is ten times as powerful as an AA cell, a B cell has ten times the power of an A cell and so on.

### AA Cell

This cell is a disk the size of a pinhead,  $\frac{1}{8}$ " in diameter and  $\frac{1}{16}$ " thick. AA cells are used to power very small items when concealability is more important than endurance, such as spy equipment. They cost \$0.25; 500 AA cells weigh an ounce.

### A Cell

An A cell is a cylinder  $\frac{1}{2}$ " in diameter and  $\frac{1}{2}$ " tall. A cells are used to power short-range radios and other devices with small power requirements. An A cell costs \$1; 25 weigh an ounce.

### B Cell

B cells are cylinders  $\frac{1}{2}$ " in diameter and  $\frac{1}{2}$ " tall. They are used to power various sorts of hand-held equipment including small, easily-concealable weapons. B cells cost \$3; 20 weigh a pound.

### C Cell

This is a 1" diameter by 2" tall cylinder. C cells are the most common power source for personal weapons, tools and equipment. They are the most familiar power source in Civilization; equipment designed for larger or smaller cells often had an adapter for C cell operation. C cells cost \$10 and weight  $\frac{1}{2}$  pound.

### D Cell

A D cell is a cylinder 2" in diameter and 4" tall. D cells power military weapons and heavy equipment; battlefields are littered with as many expended D cells as cartridge cases and machine-gun links. Each D cell costs \$50 and weighs 5 pounds.

### E Cell

Each E cell is a cylinder 4" in diameter and 6" tall. E cells power vehicles, support weapons and other power-intensive systems. An E cell costs \$200 and weighs 20 pounds.



## Armor, Space Marine — GP63A3 (TS6)

Space Marine armor is a heavily armored exoskeleton that amplifies the wearer's ST and provides protection against attack. The body of the suit is protected by inch thick plates of biphasic carbide (BPC) over shock absorbing padding, giving the wearer PD 4, DR 75 over the torso (locations 9-11 and 17-18) and PD 4, DR 50 over the limbs and head. The gloves (location 7) and face plate (location 5 from the front) have PD 4, DR 25.

The suit contains a force screen generator that creates a DR 150 screen around the entire body. This screen's protection varies with the cube of the incoming energy, so it has full effectiveness against beam weapons, half effectiveness (DR 75) against fast physical attacks such as bullets and fragments from explosions, and is completely ineffective against "slow-moving" objects such as a space-axe.

The suit's exoskeleton gives the wearer a ST of 30. The wearer makes any DX-based skill rolls at -1. If the suit loses power the user can still move, but will have to use his own ST to carry over 100 pounds of armor.

Space Marine armor takes four minutes to put on and two to take off. Each suit must be specially fitted to its wearer; refitting a suit takes two hours and requires an Armoury+2 roll. Failure means another two hours are required; critical failure damages the suit and requires repair by a Mechanic (Space armor).

The helmet has a medium-range communicator and a sensor visor that provides light-intensification and anti-glare features, halving any penalty for anything but total darkness, and automatically cutting out glare and ultra-bright light. It can magnify up to 100x, giving the wearer +3 on any Vision rolls.

The suit is airtight and pressurized for vacuum, with a radiation PF of 20. It has a life-support pack, a 24-hour food and water supply, a waste-relief system and a 12-hour air tank. It is powered for one week by a D cell, costs \$7,000 and weighs 105 pounds. In hand-to-hand combat, this armor does 3d in thrust damage, or 5d+2 in swing damage. Note that the standard space-axe does swing+3(2) damage, for a total of 5d+5(2) when wielded by the armor.

## Armor, Space Marine (Valerian) — GP63A3H (TS6)

This is a heavier version of the standard Space Marine armor, modified for the greater size and strength of Valerians. It is exactly as above, with the exceptions that it has a ST of 60, all DRs are doubled, it requires two D cells, costs \$23,000 and weighs 225 pounds. In hand-to-hand combat, this armor does 7d-1 in thrust damage, or 9d in swing damage. Note that the Valerian space-axe does swing+6(2) damage, for a total of 9d+6(2) when wielded by the armor.

## Armor, Dureum (Special Purpose) (TS7)

After dureum could be made manufactured in quantity, it became feasible to incorporate dureum inlays into armor. Armor thus enhanced has PD +1 and *tripled* DR. However, dureum has such high inertia that the ST of such armor is reduced to two-thirds its previous level.

A fighter familiar with dureum-inlaid armor can aim his blows between the inlay strips at a -8 penalty. If he hits, the armor's DR is divided by three in addition to any armor divisor his weapon may have.

## ● WEAPON AND ARMOR TABLES

Weapon	Malf	Type	Damage	SS	Acc	½D	Max	Wt.	RoF	Shots	ST	Rcl	Cost
<i>Handguns</i>													
DeLameter (T)	16	imp.	5d×2(5)	12	3	1,000	2,500	4	3~	20/C	12	0	\$630
(Norm)	crit.	imp.	5d×4	11	5	300	500						
(Fan)	crit.	imp.	5d×2(½)	10	7	100	300						
Lewiston, M5	crit.	imp.	2d+2	10	3	150	1,900	2.5	3~	8+1	9	-1	\$75
Lewiston, M17	16	imp.	5d×3	10	1	200	400	5	3~	20/C	12	0	\$120
Lewiston, M23	ver.	imp.	3d+2	11	4	250	3,000	2	3~	17+1	8	-1	\$100

### *Semi-Portables*

Standish (beam)	15	imp.	5d(2)	22	20	500	1,000	127	3~	10E	6	-1	\$870
(shell)	crit.	exp.	6d×5(4d)	20	8	900	6,000						

### **Melee Weapons**

Weapon	Type	Amount	Reach	Cost	Weight	Min ST
Space-Axe (standard)	imp.	sw+3(2)	1	\$60	15 lbs.	14
Space-Axe (Valerian)	imp.	sw+6(2)	1	\$80	30 lbs.	40
Space-Axe, dureum (standard)	imp.	sw+4(5)	1	NFS	15 lbs.	14
Space-Axe, dureum (Valerian)	imp.	sw+7(5)	1	NFS	30 lbs.	40

All space-axes can do crushing or cutting damage instead of impaling, but lose their armor divisor if so used. They require 1 turn to ready, and may get *stuck* — see p. B96 sidebar.

### **Personal Armor**

Type	PD	DR	Cost	Weight
Light Space Armor	3	10	\$100	40
Space Marine Armor	4	75+150	\$7,000	105
Valerian Space Marine Armor	4	150+300	\$23,000	225



## ● MEDICAL TECHNOLOGY

### **Phillips Regeneration (TS7)**

The Posenian master neurosurgeon who perfected regeneration was not actually named "Phillips," but was called that by humans unable to pronounce his real name. He greatly refined the unreliable and dangerous Medonian regeneration operation.

Rolls against Sense of Perception and Physician are required to perform the procedure, which takes about five minutes. The subject is given several injections, then his head is immobilized while two needle-rays, mounted on micrometered racks and controlled by exceptionally fine verniers, are used to stimulate the pineal gland. On any failure of the Sense of Perception roll or critical failure of the Physician roll, the subject develops malignant sarcomatosis throughout his body, and must make a HT daily — for the rest of his life, since he dies on the first failed roll.

One treatment lasts for life. The subject gains the advantages of Slow Regeneration (recovering 1 HT or Hit Point per day) and Regrowth (a lost ear, finger or toe will regrow in 1d weeks, a lost hand or foot in 1d+1 months, and a lost eye, arm or leg in 2d+2 months). If the GM wishes to charge the player for this operation, it is worth 50 character points.

### **Replacing Power Cells**

It takes 3 seconds to replace an A, B, C or D cell with a new one, and 6 seconds to replace a tiny AA or large E cell. Speed-Load (Power Cell) skill (see p. B52) applies to B and C cells being reloaded into weapons. Successful use of this skill reduces the time to 1 second. Life-support systems, and other items that cannot afford power interruptions, have two or more cells, so that if one is drained another takes over immediately. They are also usually equipped with a warning system to notify the user that one cell has been expended.

## Heavy Weapon Harness (TS2)

This device is a gyroscopically-stabilized, power-assisted armor mount for semi-portables. It allows a trooper in armor to carry and fire any weapon up to half the weight of the armor itself. The weapon's accuracy and recoil are figured exactly as if the weapon were mounted on the appropriate tripod or vehicle hard-point. The harness has one major disadvantage; if the wearer goes prone for any reason, it takes ten turns for him to get to a kneeling position, and another one to stand. The weapon cannot be fired when the harness-wearer is prone. The harness itself weighs fifty pounds, costs \$50 and is powered from the armor it is attached to.

## Hyper-Rotation and Dureum

The intersection of two hyper-spatial warp fields has an interesting side-effect. A smaller warp field, activated within an already existing larger one, will rotate itself (and everything within its volume of effect) out of phase with the original plane of existence. Anything so rotated cannot interact with unrotated objects at all. They simply move past (not through) one another. No natural material object, however dense, or physical force, however ravening, can affect anything that has been hyper-spatially rotated.

Shipboard hyper-rotators cost \$10,000, weigh 10 tons and take up 5 cubic yards, plus \$20, 0.02 ton and 0.01 cy for every 1,000 cubic yards of capacity. They consume ten pounds of energy to rotate that volume, and the same to un-rotate it, but no energy is required to maintain the condition.

Dureum, an artificial substance created by the Eich, is hyper-rotationally symmetrical. It will interact with all other matter, however rotated, in any plane of existence. It is very dense, weighing some 2,000 times as much as an equal volume of water. It also hyper-inert, with an inertial mass approximately 1,000 times its gravitational — its inertia is nearly 200,000 times that of an equal volume of water. A dureum bar that could be easily lifted would be very difficult to swing and equally hard to stop.

Dureum is phenomenally hard to manufacture and even more refractory to work. It is valued at some \$21,000 per ounce in ingot form. The cost of worked dureum, in useful forms such as weapons or armor, can be very roughly estimated at one million times the cost of a normal version of the item.

The actual regrowth process may require medical assistance. The subject regrows *all* parts of his body — hair and teeth as well as missing limbs, organs and nerves. Prosthetics, including pacemakers, tooth fillings, and so on, must be removed, and limb stumps may require surgical attention. Regeneration cures all physical traumas, but has no effect on the intellect, *e.g.*, Mindwipe is unaltered.

The new body parts are perfectly healthy, but have any genetic (birth) defects that the originals had, and are the same biological age as the rest of the body. New eyes may require corrective lenses, either because of old age or because of a birth defect. New teeth may need orthodonture.

New limbs form at ST and DX 0, and require physical therapy to come up to full capability. Each week of professional training allows a Will roll, plus 2 for High Pain Threshold. Success adds one to both ST and DX, critical success adds 1d, and critical failure reduces both by one. The new limb's ST and DX cannot exceed its original values, adjusted for the age of the rest of the body.

At last humanity had been given what had sought for many hundreds of years: a cure for infantile paralysis (*poliomyelitis* or "polio").

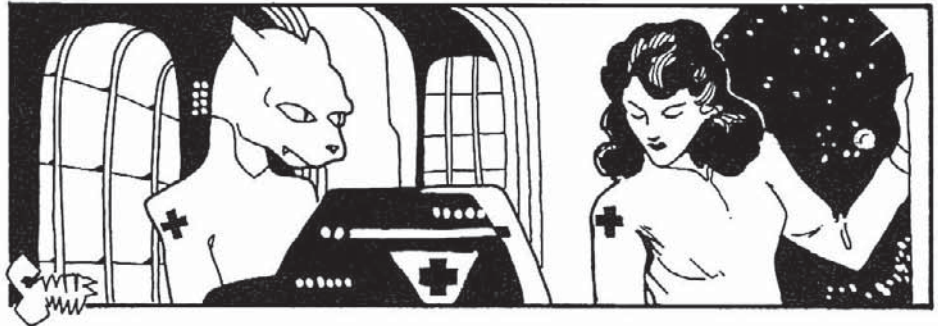

## ● THE HYPER-SPATIAL TUBE (TS8)

The master engineers of Boskonian, the Eich, devised a method of physically entering other planes of existence. The hyper-spatial tube generator creates a cylindrical warp tangent to both its own space at two locations (imprecisely, but usefully, called the "ends" of the tube), and also tangent to a large (possibly infinite) number of other spaces along its hyper-length.

When a hyper-spatial tube is first created, its points of tangency cannot lie closer to any mass than *Cardygne's Limit*, a radius determined by a complex and not yet fully understood relationship to the tube's hyper-circumference and the magnetic fields and angular momenta of nearby masses. In the case of Sol, *Cardygne's Limit* for a hyper-spatial tube that can pass a small planet is about 118 million miles, though it varies somewhat, particularly with Jupiter's proximity.

Once the tube is generated, however, mass can move closer and even into it without effect. Thus, a tube cannot be created around a planet, but it could be created ahead of the planet in its orbit so that the planet would move into the tube.

Entering a tube causes a malaise in all sentient life that is indescribably horrible. It has all the effects of extreme space-or free-sickness, except that no one has ever been able to develop a resistance to it. Everyone is affected, and is incapacitated until they make a HT roll (trying once per second, after an initial five-second period).

A generator that will create a hyper-spatial tube large enough to pass a ship is a huge installation, some 5 stories tall and fifty-some yards square. It costs about \$80,000 to build and consumes 15 pounds per hour. A tube big enough to carry a Tellus-sized planet would need a generator covering some hundred acres, costing over a billion dollars.

## ● PSIONIC DEVICES

The science and engineering of psionics is well advanced in Civilization. Devices that receive and transmit thoughts are not difficult to design and build, though thought-controlled machines are considered dangerous. Most intellects are insufficiently disciplined to *not* think the control signals at the wrong time.

## Broadcasters (TS2)

The most famous thought-broadcaster is the legendary Golden Meteor of the Triplanetary Service. A tiny gold bauble, it was carried in an insulating container and served as the unmistakable insignia of an agent of the Service. It was impossible to counterfeit for many years, because it had the property of transmitting a telepathic shout when touched. Anyone brushing the Meteor with a finger "heard" an unpronounceable syllable, the password of the Triplanetary Service, as a thrilling surge of power shooting through his very bones. The Meteor was powered by an internal source of radioactivity.

## Thought-Screens (TS6)

A thought-screen is an electronic device that generates a psychic barrier identical to a telepathic Mind Shield of skill 3. Screens' powers and radii of coverage vary greatly, from personal units to screens that blanket entire planets.

Personal thought-screens protect only the wearer. They cost \$2.50 per point of power and weigh one pound. They can be energized for one week from a B cell.

Thought-screens for space ships weigh 10 tons, take up 3 cy and cost \$1,000 plus 1 ton, 0.1 cy and \$100 per point of power. They consume 0.01 lb./hr. per point of power and per 1,000 cy of ship size.

Ground-mounted thought-screens fill 1 cy and cost \$500 per point of power and per 1,000 miles of radius cubed. They require 0.2 lb./hr. per point of power and per mile of radius cubed. Thus a thought-screen to protect a Tellus-sized planet with a power of 10 would occupy 2,160 cy (a small four-story building), cost \$1,080,000 and consume 432 lb./hr..

## ● LEGAL DRUGS

### Amphetamine

Amphetamine (trade-named Benzedrine) and its relatives such as Dexedrine and Kedeselin (all referred to as "uppers," "pep pills" or "speed") are available and quite acceptable for use throughout Civilization. They are cheap, slightly addictive and socially acceptable; worth no points as an addiction. They are appetite suppressants, and instantly restore 1d of Fatigue loss. Roll versus HT; the Fatigue is banished for a number of hours equal to half the amount the roll was made by (at least one). When the time is up, the user gets all that Fatigue back, plus 2 more.

For each dose taken within 24 hours after the first, the HT roll is at -1. Large and frequent doses produce exhilaration, and depression can occur when usage ceases. If Fatigue goes below 0, the extra points of Fatigue lost are taken as lost HT instead. If HT falls to 0, the user suffers a heart attack, blacking out for 1d minutes and taking 3d damage.

### Barbiturates

The derivatives of barbituric acid are habit-forming drugs used as sedatives and hypnotics, to induce sleep, relieve anxiety and neuroses by inducing drowsiness, and control epileptic seizures. Taken to cause a state of euphoria, barbiturates are among the most widely abused drugs. Sometimes they are used in suicide attempts.

Barbiturates act to depress the central nervous system. The rate at which they work varies widely. Some, such as amobarbital, enter the brain slowly and are used as anxiety reliefs. Others, such as secobarbital, work faster and are used as sleeping pills. Very fast barbiturates, such as thiopenal, cause sleep in seconds; these are used as adjuncts to anesthesia and as knockout drops ("mickey finns").

Barbiturates cause a loss of 1 to 6 points of DX and of IQ, depending on exact composition, as they impair judgment and motor control. Other depressants — such as alcohol, antihistamines, and tranquilizers — cause synergy, increasing the effects of all drugs concerned. An overdose results in coma and death. The human body develops a tolerance for barbiturates, requiring larger doses to produce the same effect.



### Lesser Stimulants: Coffee, Tea and Chocolate

Caffeine, found in coffee, is a mild stimulant and diuretic. Chocolate contains theobromine ("holy food"), a chemical closely related to caffeine. Tea contains theophylline ("holy plant"), an isomer of theobromine.

All are cheap, slightly addictive and socially encouraged; worth no points as addictions, though particularly heavy use is certainly a quirk.

### Alcohol

Myriad forms of alcoholic beverage are popular throughout both Boskonian and Civilization. In addition to the many Tellurian liquors, Aldebaran bolega, Martian zymol and Radeligian laxlo, among many others, are also popular.

## Thionite

Thionite is the *ne plus ultra* of drugs, the zwilnik's dream cargo. This purple powder is incredibly valuable, incredibly addictive, and totally illegal. Clear-quill thionite is a fantastically potent drug, easily metabolized by any creature with hemoglobin-bearing blood. A light dose is half a microgram; a single ounce contains over 60 million doses. The most common way to take thionite is to sniff it into the sinuses, but it can also be swallowed or liquefied and injected. It is even slowly absorbed through the skin, which requires it to be handled with care. Law enforcement typically calculates thionite's "street value" at \$10 per microgram. In practice, a user's first dose is often free, while following doses are priced at what the dealer estimates the addict is capable of paying — since the addict *will* pay anything he can for that next dose.

While high on thionite the user has the Delusion that *every* desire, mental or physical, is being completely satisfied. It also gives +3 to ST, -8 to IQ, and -15 to DX. If DX goes below 3, the user is in "muscle-lock," where "every voluntary muscle in the body goes into a rigor as extreme as death itself."

Every time a dose is taken, the user must roll versus his HT divided by the number of micrograms taken *in the past twenty-four hours* (to a maximum of 16, no minimum). If he fails the roll, he permanently loses one point of HT. On critical failure, he dies of heart failure. The high and accompanying muscle-lock come on within seconds, and last five minutes per microgram taken or one minute per point of HT of the user, whichever is longer.

It is phenomenally addictive (-15 to the withdrawal roll). *Any* time a thionite addict is in the presence of the drug, he must make a withdrawal roll or give into the craving and do *anything* to get that hit. That it may kill them is absolutely irrelevant. Most addicts make quite sure that no more of the drug is available for some time after their hit. If the withdrawal roll is *ever* failed, the addict immediately acquires Megalomania — they *know* that they can have their every desire satisfied.

Thionite is a -75 point Addiction — essentially a terminal illness.

## Fayalin

Fayalin is a "stimulating, although non-intoxicating beverage prepared from the fruit of a Crevenian shrub, *Fayaloclastus Augustifolus Barnstead*; much in favor as a ceremonial drink among those who can afford it." It is a jewel-like red in color.

At \$5-7 a fifth, fayalin is medium-priced as drugs go, mildly addictive and legal; a habitual drinker has a -5 point addiction.

## Tobacco

At 18 centos a pack for cigarettes up to a full credit for a superb cigar, nicotine is cheap, highly addictive and legal; a smoker has a -5-point habit. Civilization does *not* disapprove of smoking; to the contrary, a non-smoker has a -1-point quirk, and objecting to anything but the cheapest of bad cigars is a -5-point OPH. A severe allergy to tobacco smoke is a -5-point disadvantage (a weakness to a common substance, doing 1d per half-hour to Fatigue only).

## ● ILLEGAL DRUGS

Many of the drugs known on Tellus prior to the end of the World War are still available. In general, those derived from native plants have not remained popular, as their costs rise sharply off-world. Drugs that can be cheaply synthesized with readily available equipment have proven more lucrative. Thus, peyote and marijuana are all but forgotten, and morphine and poppy opium are rare, but heroin (a formerly-trademarked brand of synthetic morphine) still has its adherents. Exceptions exist, of course. Cocaine is popular in some subcultures of the zwilnik world and obviously thionite is immensely profitable despite — or because — of the unimaginable difficulties involved in its acquisition from the one locale where broadleaf grows.

Apart from those few exceptions, modern pharmacology has yielded psychotropics more hellish than any Nature can create.

## Bentlam

The psychoactive ingredient of bentlam (also known as "benny," "benweed" or "happy-sleep,") is *anandamide*, a chemical closely related to tetrahydrocannabinol ("THC," found in Tellurian marijuana). It is easily synthesized at a purity and potency undreamed of by the hashish-eaters of ancient Tellus. A fibrous material much like finely-cut chewing tobacco, bentlam is usually formed into small cakes, or "units" like miniature candy-bars, and chewed. For a number of hours equal to the number of units chewed, the user is in a state of euphoric intoxication.

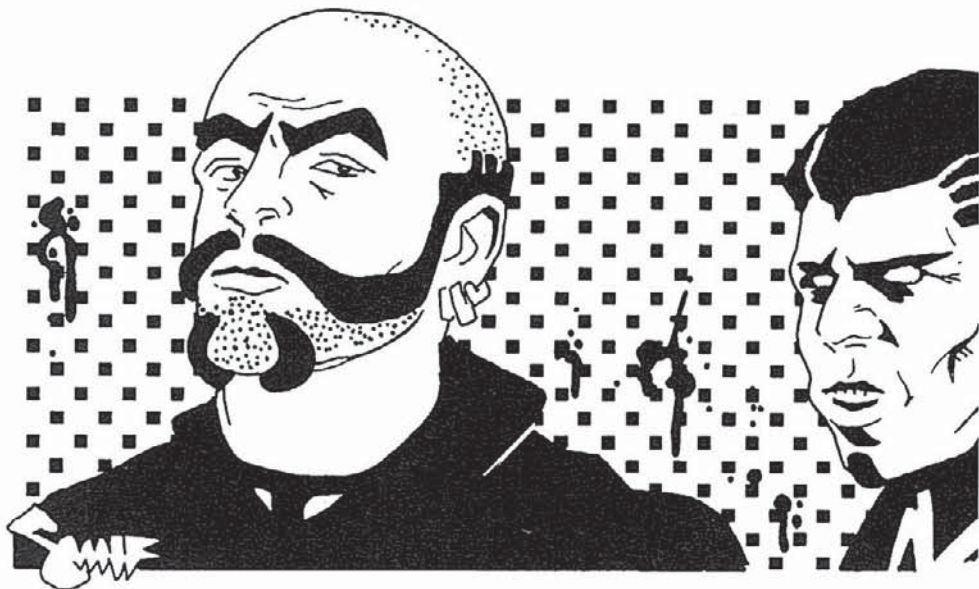

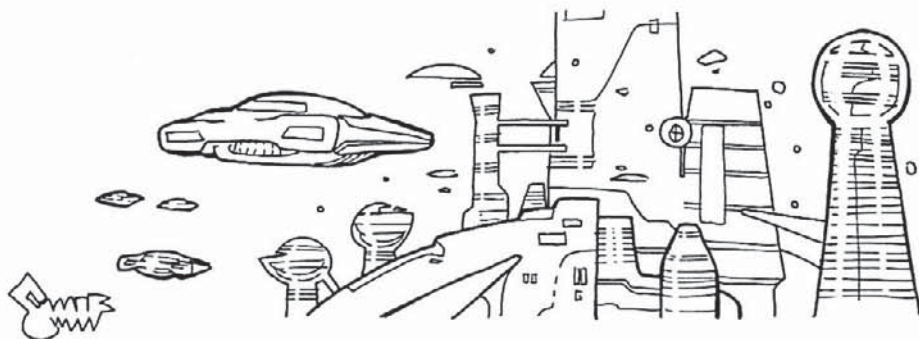

If a bentlam eater (a “benhead”) needs to do anything while under the influence, he must first work up the motivation by making a Will roll, minus the number of units chewed. Body weight reduces the drug’s effects; add the user’s weight divided by 50 pounds (rounded off). For example, a 220-lb. user with IQ 22 and five levels of strong Will who took the heroic dose of 24 units would have to roll 7 or less (22 IQ + 5 Strong Will -24 units + 4 50-lb. increments). If that roll succeeds, he has convinced himself that the task is important enough to think about. Then, in order to force his body to actually *do* what must be done, he must make a HT roll, with the same modifiers as above. If the user above has a HT of 18, he must roll a 3 — he is almost completely incapacitated. He is able to *think* fairly clearly, but his body has betrayed him.

Street prices start at \$1 per unit in quantity. Bentlam is cheap, mildly addictive and illegal; a bentlam chewer has a -5-point addiction if he can limit himself to non-incapacitating dosages, -15 points if he routinely knocks himself out with it.

## Hadive

Hadive is a black, tarry, inflammable gel with a consistency much like pudding. It is smoked in a wide variety of ways, from special water-pipes to soaking it into shredded paper and rolling a “cricket” that is smoked like a cigarette.

The name of this drug is properly pronounced “hah-DEE-vay” on Vandemar, its planet of origin — but it would be considered a humorous affectation to do so anywhere else. “HAY-dive” is universally understood and expected. The active ingredient, *synalthiozole*, can be created without much difficulty in any biochemical laboratory.

Hadive causes *synaesthesia*, an unusual “cross-circuiting” of the senses in which, for example, smells are perceived as colors and textures are audible. The effects are almost always pleasurable, so a hadive smoker is usually idiotically smiling, and they are directly related in intensity to the stimulus. A startle response will set off orgasmic sensations. Hadive dens are always full of stroboscopic lighting and deafening, discordant music.

Hadive costs \$5 for a quarter-ounce, which will provide 10-15 doses. It is illegal, cheap, stimulating and hallucinogenic; addiction is a -15 point disadvantage.

## Heroin

Clear-quill heroin costs \$10,000 per pound in bulk. On the street, it is usually cut with inert filler and sold in “trey bags” of one gram each, costing three credits.

Heroin is medium-expensive, incapacitating, illegal and totally addictive; an addict has a -30-point disadvantage.

## Ladolian

Ladolian is a thick yellowish-green liquid, aromatic and with a bitter taste. Its active ingredient, *thujone*, causes hallucinations, and prolonged use results in mental deterioration and sterility. For every ounce that is drunk, the user must make a HT roll. On a critical failure, he permanently loses a point of IQ.

Ladolian was created by the ancient Martians from native rock molds, but proved quite simple of synthesis. There is a cachet attached to *Martian* ladolian,

## Toxicity

Thionite is remarkable for its potency, but is far from being the most toxic substance ever encountered. The recommended limit on the concentration of plutonium in air is 0.00003 micrograms per cubic meter, not for any radiological reasons, but because chemically it is one of the most dangerous poisons ever known.

However, a thionite user who begins his addiction with HT 10 and takes only half a microgram a day has a life-expectancy of less than four months, considering only the debilitating effects of the drug. And of course, as the high gets shorter and shorter, he will be strongly tempted to increase the dosage. . . .

## Thionite Examples

Lensman Hanner, infiltrating the zwilniks undercover, must prove himself by taking a four-microgram thionite dose. His HT is 16, so he rolls against 4. He will be in muscle-lock for sixteen minutes. He will lose a point of HT unless he rolls a 3 or a 4. On a 14 or greater, he dies of heart failure. If he were to immediately take a second four-microgram dose, he would roll again, against 2 — losing a point of HT automatically, dying on 12 or greater.

An average new user of HT 10 who takes half a microgram rolls against 20 — actually, the maximum of 16. He will enjoy a 10-minute high. On a roll of 17, he loses a point of HT, and on 18, he dies. A long-time addict with HT 4 will have to take two micrograms to enjoy a 10-minute high, but must then roll against 2. He loses a point of HT automatically, and dies on any roll of 12 or greater.







however, and it commands double or even higher price. There is no real way to tell *Martian ladolian* from any other, though. *Caveat zivilnik*.

Though illegal throughout Civilization and quite dangerous, ladolian is a popular psychedelic in the wealthier circles. Its hallucinations alter the perceptions of the user to fit his desires. The visions have their bases in objective reality, but the user believes that whatever (or whoever) is present is what he desires it (or them) to be. Thus, a pile of trash may seem to be thousand-credit bank-notes, or a passer-by may be believed to be a devoted slave. Obviously this effect can produce both hilarious and tragic consequences.

Ladolian's bitter taste is frequently disguised by diluting it with water flavored with herbs such as licorice or fennel. The classic method, considered by aficionados to be the only "proper" way, is to use a special, finely made, and *very* expensive glass that allows ice water to seep through a sugar cube into the drug. The ultimate refinement — inarguable proof that one is a true connoisseur — is to use super-cooled Martian canal water. Ladolian turns opalescent white on contact with water.

At roughly a \$10 an ounce, it is a moderately expensive habit. It is hallucinogenic and illegal. It is not physically addictive, but psychologically it is quite seductive. A ladolian addiction is a -20-point disadvantage.

### Nitrolabe

Nitrolabe is an exception to the general rule that regionally-developed drugs do not have widespread popularity. In this case, ease of transportation explains the drug's success.

The nine-fish (*Nitroso labile*) of Centralia VI is a small amphibian, massing about a pound and vaguely resembling a nine-armed starfish, living in the alkali tidal pools of VI's ammonia-rich oceans. It is covered with a host of needle-sharp spines that secrete a nerve toxin deadly to native Centralian life. A hardy creature, it can survive most reasonable environments; in unreasonable ones, it curls up in a ball and goes into a state of suspended animation. Balled-up, their bodies are about three inches in diameter, and the needles add another inch all around.

However, all life on Centralia VI has copper-based blood. Nine-fish toxin has a very different effect on beings with iron-based blood. It still attacks the nervous system, but rather than blocking neural transmissions, it induces them. The result is an orgasmic trance that can last more than an hour.

It also has some unpleasant side-effects. It not only throws the user into a totally incapacitating twitching paralysis in which it is physiologically impossible for them to voluntarily move or think *at all*, it permanently alters the addict's neurochemistry. His nerves become unable to function without the toxin. If the addict does not get at least a dose a week, he suffers excruciating pain throughout his body as his nervous system begins to fail. Each week in which a dose is not taken, the addict permanently loses one point of DX and one hit point. This damage has all the same effects as battle damage, including consciousness and death rolls, except that it cannot be cured by anything short of Phillips regeneration.

With every dose, a user must roll against HT minus the total number of doses ever taken. On any failure, he has become addicted. On a critical failure, his nervous system fails, and he dies in convulsions. Nitrolabe is instantly lethal to all epileptics and about 1/2% (a roll of 3 on 3d) of all other humans. Those acutely vulnerable populations will automatically critically fail their HT roll.

Shipment of nine-fish is a very simple matter. Thick gloves will protect the harvester from the needles, and exposing them to pure water will cause them to estivate (nine-fish consider water without dissolved ammonia *very* unreasonable). In that state, they can be packed in a wide variety of ways, though care must be taken to prevent them from stabbing each other, since they are susceptible to their own toxin. Dead nine-fish not only do not produce nitrolabe, but also smell unbelievably horrible. An entire nine-fish is worth about a hundred credits, and will produce about five hundred needles in its life. Individually, needles costs at least \$10 each. Nitrolabe is very expensive, incapacitating, illegal and totally addictive; a -40-point disadvantage.

# SAMPLE SHIPS

## PRODIGIOUS

### A Dauntless-class super-dreadnought (TS7)

*Prodigious* was under construction when Medon arrived at alpha Centauri, providing the Patrol with their phenomenal electrical technologies. Construction was halted, plans redrawn and *Prodigious* became the first ship built with the new equipment.

*Structure:* 12 million cubic yards of hull — a tear-drop 2,100 feet long, 700 feet in diameter, massing 120,000 tons and worth \$60 million. Excellent streamlining cost another \$300 million and takes up 600,000 cy.

*Propulsion:* Jets massing 1.5 million tons, taking up a million cy, costing \$200 million and consuming 100,000 lb/hr provide one thousand megatons of thrust. The Bergenholms cost \$2.31 million, mass 2,310 tons, occupy 6,915 cy and consume 3,000 lb/hr.

*Power:* The banks of accumulators which store three million pounds of energy mass 15,000 tons, occupy 3,000 cy and cost \$6 million. The 200 400-lb/hr atomic motor-generators mass 8 tons, occupy 3.2 cy and cost \$12 million, and provide excitation for the 8-thousand-million-lb/hr cosmic ray absorption screen. It masses 400,000 tons, takes up 800,000 cy, and cost \$16 million.

*Accommodation:* 300,000 tons, 7.5 million cy, \$120 million of cabins for 300,000 officers and men. 150,000 tons, 600,000 cy, \$15 million of life support equipment.

*Weaponry:* 15 needlers, totalling \$135,000, 750 tons, 750 cy, 3,000 Firepower, 45 crew. 20 macro beams, totalling \$6,000,000, 20,000 tons, 20,000 cy, 100,000 Firepower, 500 crew. 8 three-

projector primary beam turrets, totalling \$12 million, 16,000 tons, 5,600 cy, Firepower 4.8 million, 600 crew, 1,170 rounds loadout. 20 tractors, 20 pressors and 20 tractor shears, all with megaton capacities cost \$1,230,000, occupy 120,000 cy and mass 60,000 tons.

*Screens:* The wall-screen generator occupies 625,000 cy, cost \$31,250,000, masses 125,000 tons, consumes 1.25 million lb/hr and provides a DF of 2500. The three inner screens each have a DF of 500 and total 75,000 cy, \$3,750,000, 15,000 tons and 150,000 lb/hr. The five mid-screens each have a DF of 100 and total 5,000 cy, \$250,000, 1000 tons and 10,000 lb/hr. The ten outer screens each have a DF of 10 and total 100 cy, \$5,000, 20 tons and 200 lb/hr.

*Accessories:* Commo and sensor suites total \$5,500, 15 cy and 10 tons. Indetectability suite rated at -5 cost \$4.8 million, takes up 144,000 cy and masses 48,000 tons. A nullifier-scrambler rated at -10 masses 2,560 tons, takes up 5,120 cy and cost \$2,560,000. Jammers rated at -10 cost \$170,000, occupy 100 cy and mass 1.5 tons. The display tank occupies 10 cy and cost \$250, and the ten Simplexes cost \$1,000. Artificial gravity and pseudoinertia generators cost \$120 million, mass 180,000 tons and take up 120,000 cy. The habitable cargo space is usually outfitted with a Space Marine armoury, extra magazines and electronic warfare equipment.

*Performance:* Maximum free speed 158 pph, cruising 105 pph (note that the speed will drop 50% when the indetectability suite is active). Maximum inert acceleration 333 gees (3.4 perceived). \$1,048.5 million, 3 million tons. DF 4,600, Firepower just under five million.

# 42-63510 — THE “HEAVENLY BODY”

## A 2G-BA speedster (TS7)

Strictly speaking, speedsters have no official name, but they are universally referred to by the caption of their nose art. “Heavenly Body” is one of the many excellent works of art by Lt. Anson Maynard (Lensman), showing a buxom Chickladorian with exotic green eyes, flying through a shining nebula. Lt. Maynard positioned the figure very carefully over the panels covering various sensors, and painted extra panels. Thus the pilot has a choice of displaying the figure coyly fig-leafed by curls of glowing gas, or in her full glory.

Speedsters are not warships; their defenses are feeble and they have no offensive abilities at all. “Heavenly Body” is used by the Fleet Astrographic Survey Agency to perform long-baseline gravimetric interferometry. Accordingly, it has been stripped down and fitted with jets that give her “more legs than a centipede.”

*Structure:* 500 cubic yards of hull — a wasp-waisted cigar-shape, 216 feet long and 12 feet in diameter, massing 5 tons and worth \$2,500. Radical streamlining cost \$25,000 and takes up 25 cy.

*Propulsion:* The driving jets provide 90,000 tons of thrust, massing 135 tons, occupying 90 cy and cost \$18,000. The Bergenholm cost \$90,000, masses 85 tons and takes up 255 cy.

*Power:* The accumulators which store 10 pounds of energy have negligible mass and volume, and cost \$20. They provide excitation for the 100,000-lb/hr cosmic ray absorption screen, which masses 5 tons, takes up 10 cy and cost \$200.

*Accommodation:* 1 tons, 25 cy, \$400 for the cabin, 2.5 tons, 6 cy, \$550 of lifesupport equipment for single human.

*Weaponry:* Two tractors and two pressors each with one kiloton capacities cost \$2,080, occupy 8 cy and mass 4 tons.

*Screens:* The wall-screen generator provides a DF of 20, and occupies 40 cy, cost \$2,000 and masses 8 tons. The inner screen has DF 10, occupies 10 cy, cost \$500 and masses 2 tons. The middle screen has DF 5, occupies 2.5 cy, cost \$125 and masses 0.5 ton. The outer screen has DF 3, occupies 0.9 cy, cost \$45 and masses 0.18 ton.

*Accessories:* Commo and sensor suites total \$5,500, 15 cy and 10 tons. Artificial gravity and pseudoinertia generators cost \$10,000, mass 15 tons and take up 10 cy. The display tank takes up negligible weight and space, but costs \$200. The single Simplex costs \$100. The habitable cargo space is usually outfitted with scientific equipment.

*Performance:* Maximum free speed 450 pph, cruising 300 pph. Maximum inert acceleration 330 gravities (3.3 perceived). \$157,220, 273 tons. DF 38.



# TELEPATHY & THE LENS

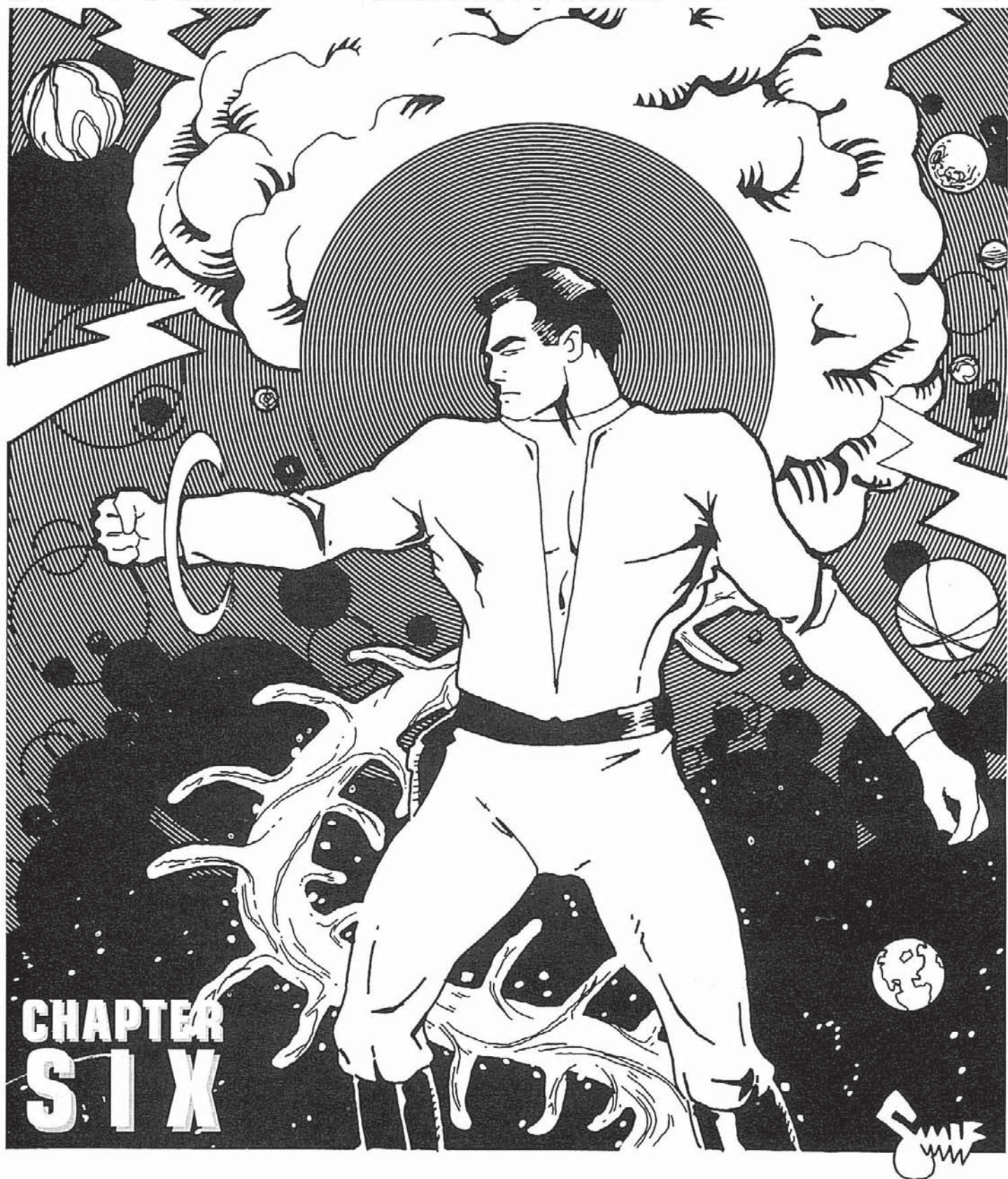

CHAPTER  
SIX

## Improving Telepathic Abilities

Use the rules for *Adding and Improving Skills* (p. B82) for telepathy skills. Telepathic Power can be improved as well, but only if the character has at least Power 1 to start with. Characters can apply experience to telepathic power or skills that were used in an adventure, or use any of the methods for *Improvement Through Study* described on p. B82:

*Finding a Teacher* is the easiest method, requiring 200 hours of personal tutoring per character point gained. However, the teacher must know the ability you wish to learn or improve at a higher level than you do. Different worlds deal with the powers of the mind in different ways — on Tellus, finding a teacher other than the Galactic Patrol is all but impossible and winning acceptance from the Adepts of North Polar Jupiter would be an adventure in itself, while the Rigellian Academy of Thought grants scholarships to promising telepaths of all races.

*Self-Teaching* of skills and powers is also possible, but unlike other skills, this takes *ten times* as long — 2000 hours per point.

*Schools* for telepaths exist on some planets — on Velantia, teachers of telepathic skills charge tuition and advertise.

*Jobs* count only if the telepath is using his skill or power as an integral part of his daily routine. They provide about 2 1/2 character points of experience per year.

## ● THE LENS

A Lens appears to be a lenticular mass of myriad tiny gems endowed with a sort of pseudo-life. When it is worn by its owner, each gem is surrounded by a coruscating polychromatic aura of light. A human's Lens is contained in a platinum-iridium bracelet worn on the wrist. (However, Lensmen going undercover have been known to push the bracelet to their upper arm or even wear it around an ankle, covered by high boots.) Other species wear them in different ways; a Velantian, for example, has it embedded in the inches-thick armor of scale and bone of his forehead (or what passes for a Velantia's forehead — see cover).

A Lens cannot be destroyed while its owner is alive. It is a philosophical construct, not a physical object. Its bracelet can be damaged, but the Lens itself would be unaffected even by the unimaginable violence of a duodec explosion or the incomprehensible nothingness of a negasphere. Upon its owner's death, a Lens dissolves in seconds to a harmless jelly.

A Lens is an unforgeable identification. Each one is absolutely unique to an individual. When it is separated from its owner, a Lens becomes dull, gray, and lifeless. Even the briefest touch of a Lens in this state is utter agony; prolonged contact does 3d points of damage per second. Since the Guardians of Civilization are ultimately trustworthy, their absolutely authentic instrumentality is as well.

A Lens also serves as a universal translator. No code or cipher can successfully hide a message from a Lensman, and no language is foreign. *Concepts* may be incomprehensible — no merely three-dimensional being can understand the process of dextrotoping, for example. Messages can also be imperceptible — a human Lensman can't understand a radio transmission without a receiver. However, a Lensman can understand any meaningful communication that he can perceive.

But most importantly, a Lens enhances whatever abilities are weakest in an incompletely developed mind. "Strictly speaking, a Lens has no real power of its own; it merely concentrates, intensifies, and renders available whatever powers are already possessed by its wearer." If the Guardians were to give a Lens to a being who had no telepathic powers whatsoever, for example, that being would not gain any. The Lens cannot create ability, only improve it, and there are limits to the improvement it can make. Humanity's drive, its indomitable will, surpassed Mentor's expectations without the aid of the Lens. Accordingly, Lenses do not attempt to improve a human's Will.

Since every race has developed different strengths and weaknesses, a Lens has a different effect on each one. Thus, a Lens grants scope to the small-minded Palainians, drive to the vacillating Velantians, range to the stodgy Rigellians, and telepathy to the psionically feeble humans. As a general rule, when in physical contact with its owner's flesh, a Lens grants 50 character points, to be used in whatever area the character's race is weakest.

Humans must put their points into Telepathy power and the skills of Telesend and Telereceive, both with at least the Interstellar Range Enhancement. Palainians must pay off their Cowardice and Weak Will, raise their Telepathy skills to Interstellar Range and put any remaining points into Strong Will. Rigellians must buy off their Weak Will, raise their telepathic skills' range to Interstellar and put any remaining points into paying off Obdurate and Hidebound. Velantians must raise their

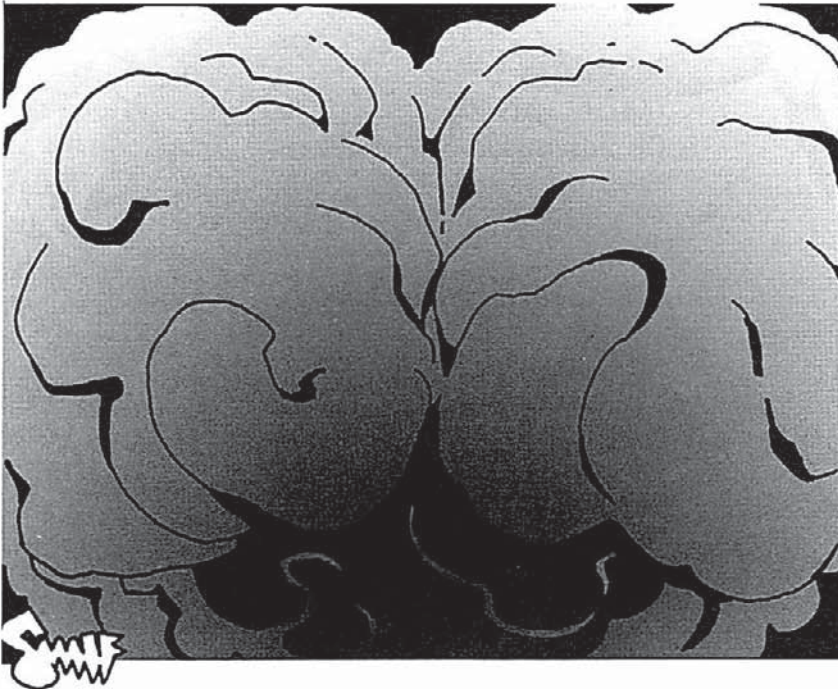

Telepathy skills' Range to Interstellar and put all remaining points into paying off Weak Will (or buying Strong Will). The GM will define where other races must place their Lens points.

Any "left-over" points that won't buy a full level of a skill or advantage are "saved" and combined with any points earned by experience for that next level. Note that all levels of Telesend provided by the Lens include the limitation Cannot Lie. (Note, too, that Cannot Lie is not the same as Cannot Mislead Via Carefully Phrased Truths Which Imply a Falsehood.)

The 50 points supplied by a Lens must be kept separate from a character's other points, since they are lost when the Lens is removed and come back when the Lens is again put on. Points acquired through experience will remain, of course. Thus, a character who buys Power-8 Telepathy with 40 of his Lens' points, and then uses ten points gained through experience to buy two more levels, is Power-10 with his Lens and Power-2 without it. Once the points supplied by the Lens are allocated, they cannot be moved. They only disappear and reappear as he dons and removes his Lens.

## ● TELEPATHY

This section is a supplement to the Psionics chapter of the *GURPS Basic Set*. Only those psionic skills conferred by the Lens and taught by Arisia that are not discussed in the *Basic Set* are listed. Some races have abilities not described here, and adepts of many planets have trained their mentalities to prodigious capabilities. See *GURPS Psionics* for a more complete description of those powers.

Note that Arisian training and the Lens give a very few specially-bred intellects prodigious capabilities that would be disastrous if obtained by lesser beings in other planes of existence. GMs are warned that many of the techniques described in this chapter are unique to a *Lensman* campaign. Use great caution when allowing players to design characters with these rules.

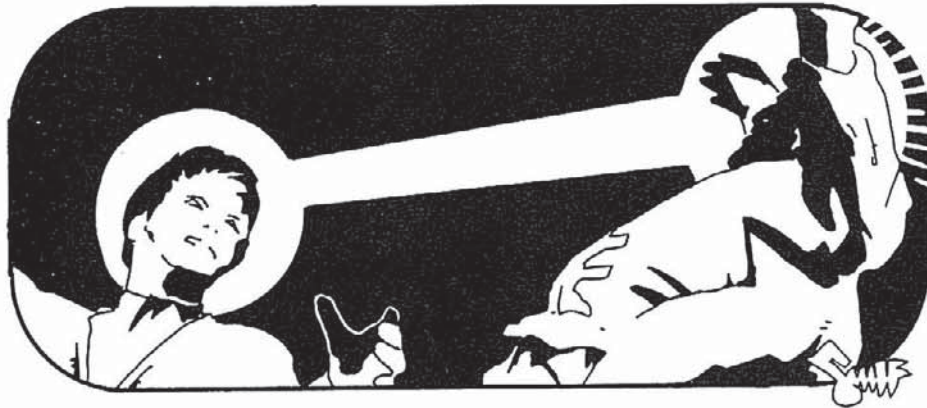

### Telepathic Skills

Most telepathic skills require great mental development to learn. All skills described here and all those described in *GURPS Psionics* except basic Telescan, Telesend, Telereceive and Mind Shield can only be learned when they are part of a racial description (e.g. Lyransians) or by intellects stable at the second level of stress. In all cases, they are Mental/Very Hard. The race descriptions will indicate which skills can be learned — a human can learn none of them unless he has the Second-Stage Stability Unusual Background.

Should an insufficiently stable character try to learn a Second-Stage skill, he will find it utterly incomprehensible. If the knowledge is forced on him, by Telesend, Mindwipe or similar direct transmission, he will suffer a Fright Check, minus the amount of his own IQ.

Meeting these requirements makes it possible to try to learn the skills without causing severe mental damage. It does not automatically make any knowledge available. The character will still have to locate a teacher or spend a great amount of time developing the techniques on his own.

## Area Attacks

Some telepathic abilities can be used against more than one target at a time. Any telepath with power 10+ can use Mental Blow, Stab or Blast skill as an area-effect blast, at a penalty of -5 to skill. The area affected is based on a global (1%) use of telepathy, on an area anywhere within normal telepathy range. Example: a telepath with Power 12 could attack an area with a 4-yard radius, anywhere within 400 yards.

With the appropriate enhancements, the Sleep and Illusion skills can also be used on groups. Normally, use of these two skills require that the attacker establish a Telereceive link with the victim first; that is not necessary in an area attack. A potential victim's Mind Shield (if any), instead of acting against the initial Telereceive attempt, modifies the attacker's Sleep or Illusion skill level.

If people with different levels of Mind Shield are caught in an area-effect telepathic attack, do not subtract Mind Shield from the user's skill before rolling. Instead, simply note how much the attacker's Mental Blow roll succeeded by. If the Power of a specific defender's Mind Shield exceeds that amount, then the attack failed to affect him.

### Global-Scale Area Attacks

As the range of telepathic attacks doubles with each 1-point increase in Telepathy power (see table, p. B167), the numbers, even with the 1% modification for "global" use, can quickly get out of hand. A psi with Telepathy-31 (like *Kimball Kinnison*, p. 47) can make a Mental Blow attack on every person in a 1,280-mile radius — or most of North America!

While there is precedent for such amazing psionic feats in the *Lensman* series — most notably the total destruction of the Eddorian race by the fusion of Mentor, the Children of the Lens and millions of Lensmen across two galaxies — GMs do not want to let this power get out of hand in their own campaign.

To fix the problem, put an upper limit on area attacks — a 1-mile radius — for attacks made by a single individual, no matter how powerful. Note that this is for damage-dealing attacks only (Could Kinnison make an entire continent see an illusion in the sky? Probably. Could he do 3d fatigue damage in a Mental Blow to every single one of them? Good question . . .) Fusions (see p. 101) are limited in area of effect to a radius of one mile per member of the fusion.

*Continued on next page . . .*



### Area Attacks (Continued)

But *somewhere* in the galaxies there is, no doubt, a race of such starkly incomprehensible mental power that a single individual *could* wipe out a planet. It is possible that both the Arisians and the Eddorians were that powerful before they left this plane of existence. If the GM allows such power in the campaign, the price must be high indeed. Such a modification to the Telepathy power ("No Limitation On Individual Area Attack Size") would cost 20 times as much as the normal Telepathy power (100 points per level instead of 5). So the power to attack an entire Tellus-sized planet would take Telepathy-33, costing 3,300 points!

### Affecting Groups: An Optional Rule

When dealing with any wide-area telepathic attack, it can be tedious for the GM to make a resistance roll for each person in the area affected. If he desires, the GM can use the *Probability of Success* table on p. B45 to determine, on the average, how many people in the area are affected by a Power.

If the attack skill roll succeeds, the GM subtracts the amount by which the roll was made from the average attribute (usually 10; modified by thought screens etc.) of the crowd. He then looks this number up on the table. The percentage indicates what portion of the crowd is likely to resist the attack.

*Example:* A Delgonian is using his Illusion-13 skill to affect a space ship crew of 10 Velantians. He rolls an 11, beating his skill by 2. The GM assumes that this crew comprises better-than-average Velantians, all with Wills of 10, and looks up 8 (10-2) on the table. This indicates that 25.9% are likely to resist. This rounds up to 3 Velantians.

### Illusion

### Prerequisite: Telesend and Telereceive at 14+

Illusion is the ability to seize control of the subject's perceptions. To try it, the telepath must already have successfully entered the subject's mind using Telereceive.

To use Illusion, take the Concentrate maneuver and describe the illusion you are projecting. At the beginning of your next turn, roll a Quick Contest of your Illusion skill versus the subject's Will. A Mind Shield does not protect, since it has already been penetrated. Illusions work best if they are of things you are familiar with: the GM may impose a -4 (or greater) penalty to create an illusion of something unfamiliar. Once successful, further concentration is not required, and a new Quick Contest is required to maintain it each minute (see below).

An illusion may totally alter the subject's sensory perceptions. It can be something as subtle as making the \$5 bill you are holding appear to be a \$100 bill, or as complex as making the subject experience the destruction of Jarnevon from the unfortunate planet's surface. You can even edit out some or all the subject's sensory input, blinding him or placing him in complete sensory deprivation, or making something — like yourself — appear invisible.

However, an illusion will never cause physical injury, and you cannot create physical sensations so potent as to be incapacitating. An illusion of being caught in an explosion will be loud and hurt a little, but won't harm the subject's ears, stun him or do any damage. But a terrifying or seemingly fatal illusion may require a Fright Check, at -1 to Will for every point the subject lost the Quick Contest by. The GM may also add further penalties to the Fright Check for other enhancing factors or particularly appropriate Illusions.

A specific illusion can be maintained without concentration by the user as long as it continues to behave as the subject expects it to. Illusionary beings can move or converse — this only takes as much effort as normal talking, since most of the "subtext" is provided by the subject's own expectations. This also applies to illusions of non-living objects. (For example, if the subject rips an illusionary paper in half, the two bits will flutter to the ground.) But making a major change in the illusion requires a turn of concentration and a new Quick Contest.

The illusion need not be within the creator's range, so long as the subject is. The illusion doesn't exist except within the mind of the subject. It is as easy to make the subject see a monster eat the moon as it is to make him see someone standing beside him.

Illusion is a powerful ability, but the subject's mind is not being controlled — just his perceptions. Someone can overcome an illusion by ignoring his senses: "By Klono's tungsten toenails, I don't care that I seem to be hurtling with inconceivable velocity past, not through, ten million universes a second — I was in my undetectable speedster a minute ago! I order my body to move forward and spray the area with DeLameter fire. Yes, I know I can't see or feel my guns, but I had them on. I tell my hands to draw them and my fingers to squeeze the triggers!" He might need a DX roll to avoid falling over and would be at -10 to see or hit anything, but it could be done.

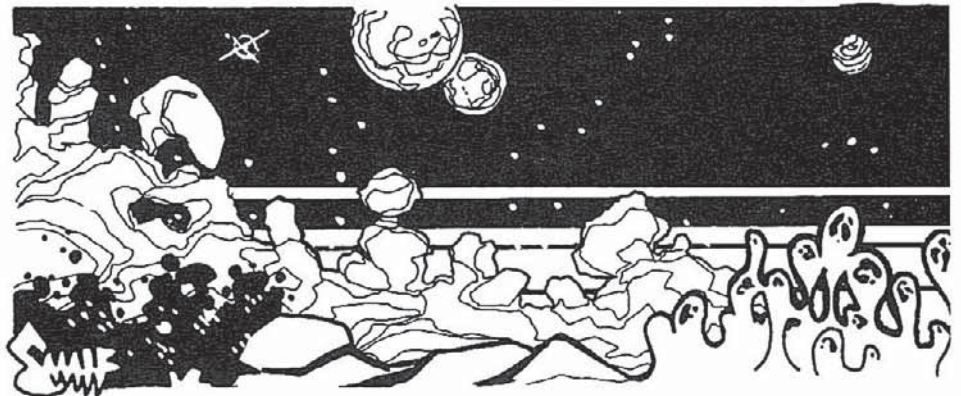

Illusion is most dangerous when it interacts with reality. For instance, a driver sees a small girl run in front of him — so he swerves off the road to avoid her. The girl was an illusion. If he had merely been blinded by a full-sensory illusion, he might have realized what was happening and could have braked the car.

*Special Skill Enhancements:* Can be used against groups of people. See sidebar, p. 94. +50%.

*Special Skill Enhancement:* You can create illusions at extremely long distances. See *Extended Range*, below.

*Special Skill Limitation:* “For Invisibility Only.” The only illusion you can create is that you are not there — your subject cannot see you. -50%

### **Mental Stab**

**Prerequisite: Mental Blow 15+**

This is a crippling mental attack. It works just like Mental Blow (p. B169) except that it costs 2 fatigue, and does 1 point of real HT damage — not fatigue — per 5 full levels of Power. However, Mental Stabs cannot be aimed at a part of the mind or at a Shield. On a critical success, a Mental Stab does 1d of damage per 5 levels of Power. A critical failure does normal Stab damage to the attacker.

### **Mental Blast**

**Prerequisite: Mental Stab 15+**

This is a *lethal* mental attack. It works just like Mental Stab (above) except that it costs 5 fatigue, and does real damage equal to the attacker’s Power. Like Stabs, Blasts cannot be aimed at a part of the mind or at a Shield. On a critical success, a Blast does 1d of damage per level of Power. A critically failed Blast does normal Blast damage to the attacker.

*Example:* A Lensman with Power-31 and Mental Blast-25 assembles a mental blast calculated to slay any living being. His target has a Mind Shield of Power 10, giving the Lensman an effective skill of 15. His roll succeeds, that target takes 31 points of damage, and ceases to live forthwith.



### **Suggest**

**Prerequisite: Telesend and Telereceive at 12+**

A telepath with this skill can project a simple feeling or emotion that can affect the actions of others. This is an indirect mental attack — it may only be used after you have already made contact with the subject’s mind using Telereceive.

To use Suggestion, decide on the message (see below) and then take the Concentrate maneuver and expend one fatigue point. At the start of your next turn, roll a Quick Contest of your Suggestion skill versus the subject’s Will. A Mind Shield does not protect, since it has already been penetrated. If you win, the subject acts on the suggestion. If your skill roll is successful, but the subject won the Quick Contest, the subject receives the emotional message, but it doesn’t influence him.

The feeling or emotion to be sent may be simple or complex. The more complex, the greater the penalty to your skill. Simple (one word) feeling-messages might be: need, love, joy, anger, danger, hunger, etc. Only primal feelings and emotions may be sent using this skill; it is up to the GM to determine whether a proposed communication meets these criteria.

Complex messages involve adding a subject, object, or qualifier to the base feeling or emotion.



### **Ricochets**

Most mental combats do not involve sufficient energies to involve any minds but the two directly involved. At extremely high levels of Power, however, the reverberations or ricochets from blocked or parried mental thrust can wreak grievous havoc among bystanders. Any time a Mind Shield blocks a Mental Blow, Stab or Blast, all minds within one-ten-thousandth of the unmodified range of the attacker are hit by the same attack, but at one-tenth full power.

*Example:* A Lensman of Power-31 launches a Mental Blast at his foe. That being — apparently a rogue Arisian! — has an amazingly strong Mind Shield, and the Blast fails to penetrate. The Boskonian ripostes with a Power-40 Blast, but his thrust is defeated in turn by the Lensman’s Shield. Both are now fatigued but undamaged.

However, every other intelligent being for more than ten miles around has been attacked by Mental Blasts of Power-3 and Power-4. Those without Mind Shields of their own have taken 7 points of damage.

The battle continues for many more turns. When it finally ends, a large number of bystanders are dead.



## Deathscream

Any being with Telesend skill will broadcast a powerful, stunning “dying scream” when killed, unless he is either killed instantly and by total surprise or dies very peacefully and contented (GM’s decision). One may try not to death-scream; make a Will roll to avoid it.

A deathscream is treated exactly as a Shout (see *Telesend*, p. B168) except it is much more powerful: subtract the dying telepath’s Power from the HT save, and for every point the HT roll is failed by, the user is automatically mentally stunned for 1d+1 turns. Only after this period is over can a roll against IQ be made to recover.

Normally a deathscream can only stun, but for someone who is actually in mental contact via Telereceive with a telepath who delivers a deathscream, the effect is much more severe. The telepath’s mind shield does not protect, and he takes one point of damage for every point he failed his HT roll by.



A *subject* is the entity expressing the emotion. Adding a subject to the basic “danger” could generate the messages “I’m in danger,” “you’re in danger” or “the world is in danger.”

An *object* is what the emotion or feeling is expressed towards. This is the difference between “hungry” and “hungry for pretzels.”

A *qualifier* describes or limits the feeling, subject, or object and must be limited to something that can be communicated in simple, empathic terms, like “pull the green handle” or “take the shiny things.”

Subjects, objects and qualifiers each add a -5 penalty to the roll, but this may be modified by the GM. Add +3 for an object or subject well-known to the receiver, and +2 if it is in the subject’s presence. Suggestions about objects or subjects unknown to the receiver will have no effect.

Modifiers are cumulative. For instance, communicating “this torture chamber is actually a hospital,” if the receiver is currently perceiving the torture chamber, is at -5 (subject), +2 (subject present), -5 (object) and +3 (object is well-known) for a total -5 modifier. “You need medical attention” has a -2 modifier.

A targeted subject who succeeds in the Contest is immune to further Suggestions for (IQ) minutes. The GM makes an IQ roll for any telepath who resists a Suggestion. If successful, he realizes that an attack has occurred. On a critical success, the GM should give a clue to the identity of the attacker.

*Special Skill Enhancement:* You can send a Suggestion an extremely long distance. See *Extended Range*, p. 102.

## Compulsion (“Telecontrol”)

**Prerequisite: Telesend and Telereceive at 15+**

This is the ability to take over the victim’s mind and operate him from a distance like a puppet. Compulsion may only be used after the telepath has successfully made contact with the subject’s mind using Telereceive.

To establish a Zone of Compulsion, take the Concentrate maneuver for one second. At the start of your next turn, roll a Quick Contest of your Compulsion skill versus the subject’s Will. A Mind Shield does not protect, since it has already been penetrated. If you win, the victim is under your control. If you lose, the subject is alerted to your presence: he feels you in his mind, and further attempts to compel that person have the usual penalties and fatigue costs for repeated attempts.

A controlled victim is operated like a robot. You can order him to say or do anything you wish. You can make him use his own physical or mental skill, or you can use your own mental (not physical) skills through his body. You do not have access to his memories, nor can you ask him for advice.

Compulsion requires great concentration. Although the user need not take the Concentrate maneuver each turn to control his puppet, he will be at an extra -4 on skill rolls if he wants to do anything else — either telepathy or a normal skill. It is possible to control more than one victim at a time, but attempts to control each successive victim will be at a cumulative -4 to Compulsion rolls and anything else the controller attempts, and the puppets will have slurred speech and DX-4.

Once established, Compulsion may be continued for as long as you wish. A new Contest of Compulsion versus Will is required for each minute that you stay in the subject's mind, but this requires no concentration and costs no fatigue, even on a critical failure. However, you are at -4 to skill for each extra person you control, and failure lets the subjects break free.

When control ends, the controller may choose whether or not the victim will remember anything of what happened during the period of control, or the attack itself. After a victim has been controlled once, you have a +2 on any further attempt on the same victim; this decreases to +1 after a week has passed, and is gone after a month.

### Telescan

You can "search" an area and hunt for a specific person's mind. This takes a turn of concentration and a Telescan roll. Although you must specify who you are looking for, you need not be able to see or even clearly visualize your target, and you never suffer range penalties to your skill.

Your range is not divided by 100 for this skill. If the person you're searching for has a Mind Shield, its Power is subtracted from your Telescan skill. Other modifiers are as follows:

You've never met the subject: -8.

You've met the subject once (physically or mentally): -4.

You've met the subject several times: 0.

Subject is a casual acquaintance: +1.

Subject is a friend: +2.

Subject is a close friend: +3.

Subject is a close family member: +5.

A successful skill roll will tell you the direction and distance to the subject — a critical success will give you a mental picture of the area he is in as well. A critical failure will alert the subject that he is being scanned for. How he reacts to this will depend on his familiarity with telepathy.

If you succeed, you can maintain this skill continuously, to track a person. No extra concentration is needed, but an additional roll at +4 is required each minute. If this roll is failed, you have lost your target, and must begin the process over again, with penalties for repeated attempts.

If you have a "lock" on a subject via Telescan, the range penalties for using telepathy on an "unseen" subject are reduced to -3. As long as you have a Telescan "lock" on the subject, you may use telepathy on him while he is in range but out of sight, even if he is not "familiar" to you.

*Special Skill Enhancement:* You can search for categories of people, such as "any Boskonian" or "any mentality that might be Lensman-qualified." You will pick up the nearest being meeting the qualifications, if any are within range. +50%.

*Special Skill Enhancement:* You can search at extremely long distances. See *Extended Range*, p. 102.



### Combination Attacks

A Mental Blast can be made even more effective by combination with particularly horrifying Illusions. If *in the immediately preceding turn*, the victim failed a Fright Check brought on by a successful Illusion, and the Mental Blast succeeds, then the damage done is equal to the attacker's full Power *plus* the number rolled on the Fright Check Table.

*Example:* A Lensman uses his Illusion skill to make a murderer relive every crime he ever committed — from the point of view of the victims. The murderer is robust, with a HT of 12, and strong-minded, with an effective Will of 15. The Lensman has Power-31 Telepathy with an Illusion skill of 27 and a Mental Blast of 25.

The Lensman wins the Illusion's Quick Contest by 16, and the murderer fails his Fright Check by 11. The Fright Check Table roll results in a 21. The murderer begins screaming in unimaginable terror.

At the climax of the Illusion, when the illusory victims die, the Lensman succeeds with his Mental Blast, doing 31 points of damage. The terror of the Illusion adds the 21 that was rolled on the Fright Check Table, for a total of 52 points of damage. The murderer is now at -40 HT and is likely to die.

The danger associated with this technique is that a telepathically skilled victim may be able to take control of the illusion and reverse the attack. If the victim does *not* fail the Fright Check, in the following turn (when the Mental Blast would be launched), the victim can initiate a Quick Contest of Illusion skills. If the former victim wins the Quick Contest, he turns the Illusion back on the attacker, who must take the same Fright Check as his erstwhile victim, but at +5. If the attacker fails his Fright Check, he can be attacked with a Mental Blast in the following round, exactly as before. If he succeeds on his Fright Check, he can dispel the Illusion with no further effects.

*Example:* A Lyranian launches a Combination Attack on a Lensman, beginning with the Illusion of a monstrous beast leaping for his throat. The Lensman succeeds on his Fright Check, and attempts to take control of the Illusion. He wins the Quick Contest of Illusion skills, and the beast reverses itself in midflight, leaping now for *her*. She makes her Fright Check roll, though, and the beast dissolves, its talons mere inches from her throat.

## Advanced Techniques

Even the basic telepathic skills, knowable by the most primitive minds, can be used in very sophisticated ways by more advanced intellects.

Characters with Second-Stage Stability can certainly use all of the following techniques. The GM will determine which techniques are available to less highly-developed minds — the various races develop in different ways.

### Aimed Mental Blows

Mental Blows (see p. B169) normally only stun and fatigue their target. They can also be aimed at “parts” of the mind to cause pain, paralysis and even actual damage, or can be targeted at a Mind Shield (p. B169) itself. There is no penalty “to hit” but damage is usually less than would have been inflicted by normal fatigue loss. The targets include:

*The Ego:* Mental Blows aimed at the Ego are resolved at normal skill chance, but do no physical damage. Instead, a Mental Blow to the Ego results in the target losing his sense of self. It can only be used on conscious opponents. Roll damage normally, but do not apply it to fatigue. For every 2 full points of damage rolled, the subject’s Will is reduced by 1. If this ever reduces his Will to 3 or less, the target effectively becomes an automaton or zombie, with no volition of his own, though he will listlessly (at -2 to DX and IQ) obey anyone’s orders. If Will is reduced to 0, the target loses any will to live, and passes into a coma; unless he is on life-support, a HT roll is required each day to stay alive.

*The Central Nervous System:* A Mental Blow can be aimed at the motor centers of the target’s brain, disrupting his nervous system and causing great pain, loss of coordination and eventual paralysis. Roll damage normally, but do not apply it to fatigue. Instead, for every 2 full points of damage rolled, reduce the subject’s DX by 1.

*The Memory:* A Mental Blow can be aimed to disrupt or destroy short-term memories in a manner similar to electroshock therapy. This is not as precise as Mindwipe. It only works on conscious opponents. If the mental blow succeeds, roll damage normally, but only apply half of it (round up) to fatigue. The other half is the number of minutes of short-term memory lost prior to the mental blow. Example: damage rolled from a mental blow is 5 points. The character loses 3 fatigue and the last 2 minutes of his memory.



### Telereceive in Battle

Any telepath can use Telereceive in a physical battle to read opponents’ thoughts during the fight and learn what is planned before it is actually done. Remember that if the telepath is injured, he must make a Will roll to maintain his ability.

To read a foe’s combat intentions, the Telereceive attempt must succeed by at least 3 points.

The telepath gains +2 to active defenses against that subject (he know exactly when to parry, dodge, etc.) and the subject has a penalty of -1 on his active defense, since the telepath can predict how his opponent will react.

If you guess your mind is being read, you can try to fight without planning (and thus mentally telegraphing) your actions. This reduces skill level by 3, since you must rely totally on reflexes rather than strategy, and you may not Feint. If you have Combat Reflexes, only reduce skill by 2, as you are better able to act based on reflex rather than planning.



*A Mind Shield:* A Mental Blow can be targeted at a Mind Shield rather than its user. The target’s Mind Shield Power protects the shield with only half its present value (after reductions from previous damage to it or Brute Force, p. 99). If the attack succeeds, damage subtracts from the effective strength of the Mind Shield rather than the subject’s fatigue. If an attack does enough damage to a shield to reduce it to Power 0, any excess damage is applied to the owner’s fatigue. An electronic Thought Screen can be affected as well as a physical Mind Shield. Reducing it to 0 Strength shorts the device out — it will require an hour, proper tools and a successful Electronics (Psychotronics) skill roll to repair.

A Mental Blow aimed at a Mind Shield will never stun the target; other aimed Mental Blows still Mentally Stun the subject if they succeed, and the subject fails his HT roll.

Lost points of DX or levels of Strong Will or Mind Shield are regained at a rate of 1 per 10 minutes. Added levels of Weak Will are lost at the same rate. However, if Will is reduced to zero, only outside aid can restore any will at all. Until outside help has restored all the victim's Will, none will "heal" by itself.

The victim of a Mental Blow, aimed or general, if he is telepathic and still conscious, gets an automatic passive roll against his own Telereceive or Mind Shield, whichever is highest. A successful roll gives information about the attacker. If the roll succeeds by 1, the victim learns the approximate direction of the attacker. By 3, he also learns the approximate distance. If he succeeds by 11, he gets an image of the attacker's personality (or recognizes him, if he knows him already).

### **Brute Force Attacks**

Even with superior skill, getting through a Mind Shield (p. B169) can be almost impossible if the target has high Power. However, an attacker opposed by a Mind Shield can attempt to use his own Power to batter through the shield by sheer force.

Use of "brute force" must be announced before the roll is made to determine success. It allows the attacking telepath to subtract half (round down) his Telepathy Power from the Shield's effective strength. If the target doesn't have a Shield, or if the Shield's strength is reduced to 0 through this method, brute force does not increase the chance of success any further.

A brute-force attempt always costs 2 fatigue points (and any following attempts will cost an additional 2, for a repeated attempt against a mind shield), unless a critical success is rolled which only costs 1 fatigue. The attempt will always be noticed and will always give the victim some mental picture of its source's personality. If the victim knows the attacker, he will recognize him.

Any telepath can use brute force.

*Example:* The Lensman in the previous example uses his Telereceive against the murderer. The Lensman has Telereceive-22 and Power 20 Telepathy, while the murderer has an Unconscious Mind Shield of Power 14. Normally the Lensman would need a 8 or less to penetrate the shield, but time is of the essence and he uses Brute Force. This reduces the Mind Shield's Power by (20/2), or 10, to 4. The Lensman now has an effective skill of 18, and will lose 2 fatigue in the attempt.

The murderer knows exactly what is happening, and will have a chance to deal with it — see *Get Out of My Mind!*, p. B170.

### **Subtle Subversion**

Artificial thought screens have a severe drawback that can be exploited by a skilled operator — they never change. A mind, however patient and durable, constantly fluctuates and grows. The finest details of this evolution are unpredictable by any intellect resident on this plane of existence (although the macroscopic path that mind will take is quite predictable by any third-stage mentality). It is just those fine details that make a Mind Shield so difficult to penetrate, and it those details a thought screen lacks.

A skilled telepath can synchronize his attack with the deterministic patterns of a thought screen, and penetrate it without the use of great power and without alarming the screen's operator. This attack takes great patience and time; the thought screen must be immobile during the attack.

Use of "subtle subversion" must be announced before any roll is made. It allows the attacking telepath to attack only as much of the screen as he chooses. If his attack succeeds, he has reduced the screen's effective power by one-tenth (round down) of the amount he chose to attack — only for himself, and only as long as he maintains full concentration. No one else may take advantage of his work, and if he is distracted, all his progress is lost.

A subtle attempt can only be detected if the infiltrator rolls a critical failure. On a normal failure, the infiltrator loses a fatigue point and makes no progress. On a critical success, the screen's effective power is reduced by one-half (round down) of the amount he chose to attack.

### **Undetectable Mindwipe**

A highly skilled telepath can take extra pains to make his Mindwipe difficult to detect. Every -3 extra penalty he accepts before rolling to perform the Mindwipe skill gives any other telepath a -1 on trying to detect the Mindwipe later.

A telepath cannot use Undetectable Mindwipe on himself.

### **Wide-Open Two-Way**

If two telepaths each have both Telesend and Telereceive skill at 10 or better, they may choose to enter a *wide-open two-way* (sometimes known as "full communion" or *en rapport*). Each is aware of everything the other thinks and perceives, and communication is 10 times faster than speech.

Telepaths in a wide-open two-way experience an exceptionally deep form of mental rapport that transcends normal communication.

It is impossible to lie in a wide-open two-way.

Entering a wide-open two-way is a precondition for establishing a telepathic fusion.



## Wide-Open N-Way

Even if two or more telepaths are “in” the same mind, they cannot communicate directly through the third mind. They can use it as a “relay station” only if that third mind is a telepath of the second stage of development, actually listening and repeating the message from one mind to another.

The linkage formed from many simultaneous two-ways with a Second-Stage coordinator, who echoes any one mind’s thoughts to all others, is called a “Wide-Open N-Way.”

## Detecting Mindwipe

Any telepath can detect the effects of Mindwipe on another’s mind (p. B171). Victims of Mindwipe also have a chance of noticing that their minds have been altered, by looking for gaps or breaks in their memory chains.

A victim must first become suspicious. Players must have a reason to be looking for alterations, and checks cannot be repeated until new suspicions are aroused. A roll against IQ-5 will find one break, if any are present. Failure gives the wrong answer — either existing Mindwipe effects are missed, or an unaffected character believes he has found a memory splice!

If the character already has an idea of what was changed, a search takes ten minutes. If the search cannot be narrowed, and he must review his whole life, an entire day must be devoted to the task.



“Repeated attempt against a shield” penalties apply; if the attacking telepath tries more than one subversion within five minutes, he loses two fatigue points and the second attempt’s skill is penalized by a cumulative -1.

*Example:* A Lensman with Telereceive-30 needs to penetrate the Power-50 Thought Screen guarding a Boskonian fortress. Normally, he would have no chance of penetrating such a strong shield (even were he willing to raise the alarm by a crude “brute force” attack; see above). He begins Subtle Subversion, attacking only 20 points of the Screen’s Power. He now has an effective skill of 10. If he succeeds, the Screen now has Power 48 (relative to him only). Five minutes later, he tries again, and if successful, reduces the effective Power of the Screen to 46. After an hour and a half of proceeding at this rate, the Screen has been reduced to Power 18. Forty minutes after that, the screen is at Power 10, and in five more minutes, he is through the screen. Unless the Lensman rolled a critical failure, no Boskonian has the slightest suspicion how brief is their time remaining on this plane of existence.



## Temporary Mindwipe

A Mindwipe (see p. B171) can be made temporary. In this case, the real memories are not erased, only hidden in the subject’s subconscious. The user must decide on a trigger to unlock the hidden memories (or erase implanted ones). This may be an event (*e.g.*, meeting someone, or going somewhere) or simply the passage of a predetermined amount of time. Attempting a temporary Mindwipe is resolved like a normal Mindwipe attempt, but at an additional -3. On a critical failure, the trigger was improperly set, and will not activate — the Mindwipe is permanent!

Temporary Mindwipe is useful for withholding secrets from normal or telepathic interrogators. A telepath can even use it on himself — this is useful when infiltrating hostile groups who have access to Telepathy.

*Example:* A Lensman wants to pose as a tourist, to infiltrate a Boskonian-held world, but all arrivals are probed for hostile intent. To prevent them from learning who he is or his connection to the Patrol, he uses Mindwipe to edit his memories so that even he himself can find no trace of three-quarters of his knowledge and skills. He sets a trigger to restore his memories when he encounters what he needs to know, but unfortunately, he rolls a critical failure — he fools the telepathic examinations and later discovers the Boskonian plans, but because the trigger fails to activate, he is nothing more than a Boskonian businessman! Unless someone undoes the tampering using Mindwipe skill, the Lensman will never regain his true memories . . .

## Telepathic Fusions

In a *fusion* (also called a “gestalt”), two or more telepaths combine their minds into a single more powerful whole to focus their power.

One member of the fusion must be chosen as its coordinator, responsible for holding the massed minds together. Each individual must enter into wide-open two-way (sidebar, p. 99) with the coordinator. This requires that they make telepathic contact with the coordinator using Telesend and Telereceive, and the coordinator must do the same with them.

A fusion can only initiate a single feat at once, as directed by the coordinator. If the fusion is using an active skill, all its members must concentrate on it. Compute range from the coordinator (with good enough telepaths, it is possible for a fusion to be widely dispersed). The skill of a fusion is that of the most skilled member. But since the minds are linked, any fatigue loss and the effects of critical failures are jointly suffered by all participants in the fusion.

The fusion’s Power is equal to that of the strongest member in the group, plus a bonus based on a fraction of the total power of all other members. Use the table below to determine the actual bonus:

Total Power	Power Bonus	Total Power	Power Bonus
1-3.....	+1	36-48 .....	+6
4-8.....	+2	49-63 .....	+7
9-15 .....	+3	64-80 .....	+8
16-24.....	+4	81-99 .....	+9
25-35.....	+5	100-120 .....	+10

Further increases follow the same progression: the bonus is equal to the square root of the total added Power, rounded down. In the brute-force assault on Eddore’s thought screen, every Lensman of Civilization formed a fusion coordinated by Mentor. It wielded a total Power on the order of 10,000.

Note that neither Mentor of Arisia nor the Children of the Lens was a fusion. They were and are *Units*, similar to fusions only in the sense that a multicellular animal is similar to a slime mold. (The “Mentor” Unit was a less-well-developed example of a Unit than the Children, but there is little difference between a spider monkey and a human from the point of view of the slime mold.) The most obvious differences are that while a fusion can only initiate a single feat, chosen by the coordinator, a Unit can and does perform at least one feat per member, and a Unit can serve as the individual coordinator of a fusion. However, since Units are impossible to any mind of less than the third stage of development, further details are unnecessary here.

*Special Skill Enhancement:* You can transmit your thoughts extremely long distances. See *Extended Range*, below.

*Special Skill Limitation:* Cannot Lie with Telesend. -30%.

## Enhancements and Limitations

An *enhancement* is something that makes a telepathic skill more useful — Extended Range, for example. A *limitation* makes a telepathic skill less useful — Cannot Lie is an example. The GM must disallow any modifier that he feels is abusive or inappropriate. In particular, Extended Range would be extremely inappropriate for many non-Lensed campaigns.

Enhancements and limitations are described in terms of a percentage. For example, a +20% enhancement reflects a 20% increase in the final cost of the telepathic skill, rounded up. Enhancements are applied to *skills* rather than the entire telepathy *power*, which is always 5 points per level. This changes the effectiveness of that specific skill without affecting other skills. Only the cost of that specific skill is changed. In *GURPS Lensman*, there are no enhancements or limitations that apply to the entire Telepathy Power.

Always compute the cost of the unmodified skill first, and round the cost up to the nearest whole point. Then total all modifiers before determining final cost. For instance, a +20% enhancement and a -30% limitation result in a net -10% on cost. Minimum cost is one full point.

## Telepathic Eavesdropping

Any telepaths of the same level of development (both with Second-Stage Stability or both without) reading the same subject’s mind will notice each other unless one is deliberately hiding. In that case, make a Quick Contest of Telereceive skill (the GM may make the rolls to keep secrecy). If a telepath is looking for mental intruders, he is at +2 to skill to notice.

A telepath will *automatically* notice any others of lower level, and has no chance of spotting any of a higher level.

A telepath who escapes notice will be able to listen in on any Telesend. He will also notice, but not be affected by, attempts to use Compulsion, Sleep, Suggestion or Mindwipe.

If both telepaths are trying to hide, and neither is aware of the other, the GM should roll two contests — one to see if A notices B, and the other to see if B notices A.



*Example:* A Lensman is buying Telesend with System-Wide Range. IQ+2 would ordinarily cost 8 points, but the enhancement adds 25%, so that skill level would cost 10 points. To raise it to another level would cost an additional 2.5 points, since IQ+3 usually requires 10 points, which the +25% makes 12.5 points.

## Telepathic Assistance

If a telepath is controlling a subject with a Zone of Compulsion, reading his thoughts with Telereceive or influencing him via Illusion, another telepath can attempt to stop it, as long as he knows the skill that is being used on the subject.

This requires entering the subject's mind via Telereceive; the intervening telepath must be aware of the intruder. This will be automatic if the subject is affected by a Zone of Compulsion or an Illusion; for Telereceive, see the sidebar *Wide-Open N-Way* on p. 100.

Evicting a hostile telepath requires a Quick Contest of skill between the two telepaths. The friendly telepath must concentrate for a turn, then roll against the same skill as the intruder, e.g., Illusion versus Illusion. Both telepaths add their Telepathy Power to their skill. If the friendly telepath wins, the intruder is forced out of the subject's mind. If he loses, he can try again, but at normal penalty for repeated attempts. Win or lose, the intruder will be aware of the friendly telepath's attempt.

## Extended Range

While your telepathic power itself is not changed, its range is greatly extended. GMs should carefully consider the effects of this enhancement on game-balance, possibly restricting it to "packages" — as part of a race's description, for instance, or provided only by a device such as the Lens.

This enhancement can only be applied to certain skills, such as Telesend (but not the stunning "Shout") and Telereceive. See the individual skill descriptions. It does not affect the range of "global" feats. Their range is still 1% of the range indicated by their unmodified Power.

*World-Wide Range (+10%):* You can telepathically reach anywhere on your planet, its satellites and to high orbit. Your range is several thousand miles. Most naturally telepathic races have this range.

*System-Wide Range (+25%):* Your telepathy spans your stellar system, its range measured in hundreds of astronomical units (tens of billions of miles). Velantians naturally have this range.

*Interstellar Range (+50%):* You can telepathically reach the nearer stars. Your range is hundreds of parsecs. This is the range of the First Stage of Lensmanship.

*Galaxy-Wide Range (+75%):* Your telepathy extends throughout your galaxy, a range of tens of thousands of parsecs.

*Intergalactic Range (+150%):* You can telepathically reach nearby galaxies. Your range is several million parsecs. Intellects of the second stage of development have this range.

*Universal Range (+300%):* Your telepathy spans the observable universe, several trillion parsecs. This range is attained by intellects at the third stage of development such as Arisians and the Unit.

*Infinite Range (special):* You can telepathically contact any mind wherever situate, in any macrocosmic universe or plane of existence. This range is unusual; in the Records of the Guardians it has only been observed once. Clarrissa, aided by The Unit, reached it under unique circumstances.

*varies*

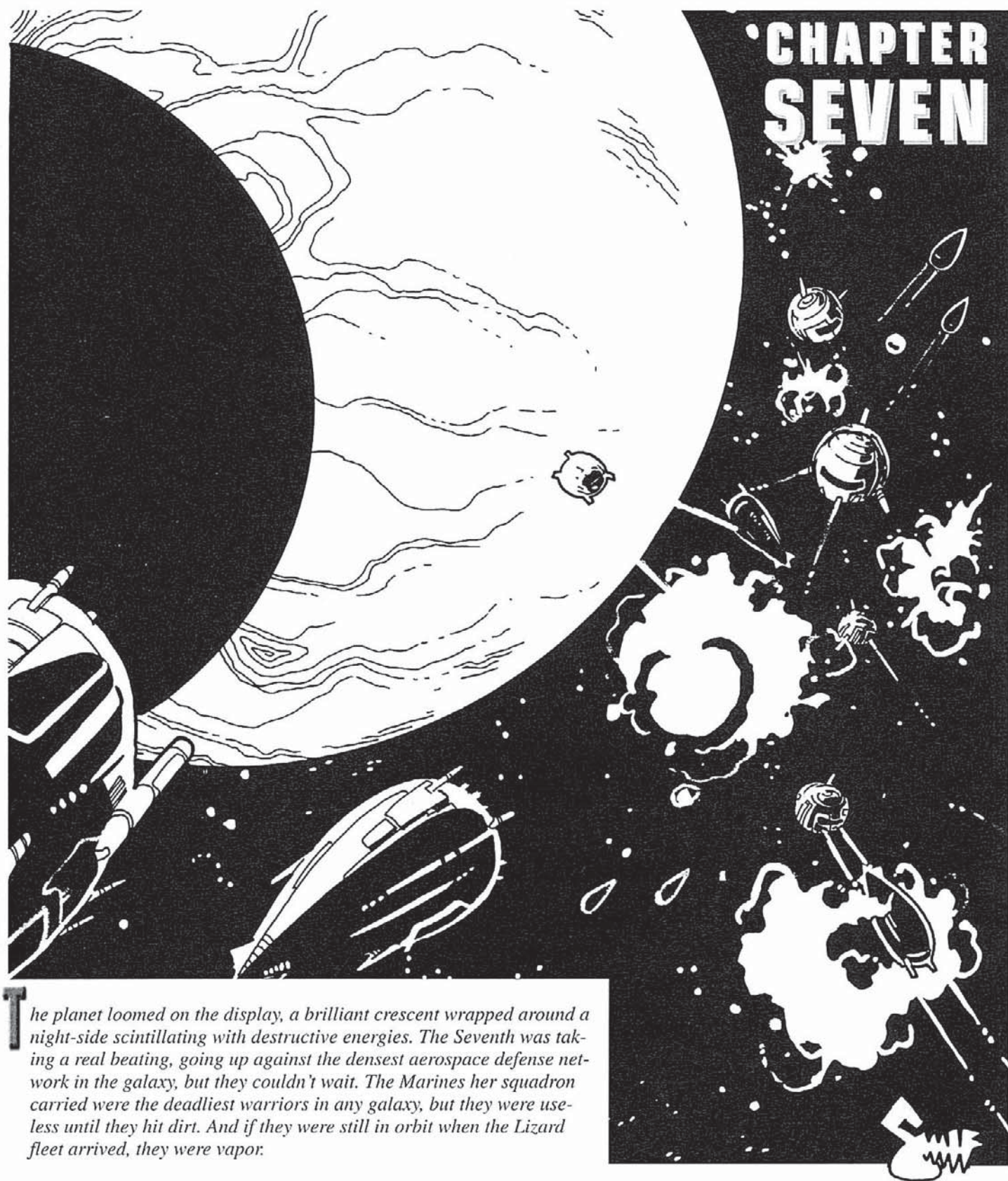

CHAPTER  
SEVEN

The planet loomed on the display, a brilliant crescent wrapped around a night-side scintillating with destructive energies. The Seventh was taking a real beating, going up against the densest aerospace defense network in the galaxy, but they couldn't wait. The Marines her squadron carried were the deadliest warriors in any galaxy, but they were useless until they hit dirt. And if they were still in orbit when the Lizard fleet arrived, they were vapor.



## “The Scream of Escaping Air . . .”

Noticing an air-leak in a spacecraft is very easy (IQ+4 for anyone with space crew experience, IQ for anyone who has gotten even a basic passenger briefing or even seen a space opera movie) but precisely locating it can be extremely difficult. Air escapes into vacuum at high speed, reaching the speed of sound as it passes through the hole. It makes tremendous noise, vibrating the very structure of the hull, but the Doppler effect lowers the tone to a deep, loud roar that seems to come from all directions. Ruptures (large leaks) whip light items into the air, blinding and distracting anyone present. Bulkheads and furniture create wild turbulence, blowing debris in every direction.

Pressure loss is terrifying. Experienced crew must make IQ rolls (with up to +4 for experience and any bonus from Combat Reflexes) to avoid mental stunning. Untrained passengers must take Fright Checks (with no bonuses — they don't understand what's happening).

To locate a hole, each turn roll IQ-10, plus the size of the hole in square inches, with a bonus of up to +4 if trained in decompression drills (Vacc Suit skill above default).



“Bogies!” the sensor op barked. “Thirty-plus small craft approaching rapidly, looks like a fighter wing. Contact in twenty seconds.”

The Lizards were in a big hurry, and close, sending their fast fighters ahead of the main fleet. Commodore Sieuxaimille closed her eyes for a moment. If they weren't ready now, no more orders would help. “Hold formation. Fire at will.” Their own fighter wing was outnumbered and wouldn't be able to hold the Lizards back. Things were going to get very tangled when the small craft started chasing each other through the formation. She hoped the gunners' identifiers would be up to the challenge.

Battles fought in space are very different from those in atmosphere or on the ground. Individual valor counts for less, technology for more. However, no matter how advanced the technology, how sophisticated the machinery, *warriors* do the fighting — not gadgets.

This chapter presents a fast and colorful method of resolving ship-to-ship and small space-fleet actions in any space opera campaign. The Space Opera Combat System (SOCS) is not a wargame, nor does it attempt to be “realistic.” It is a *role-playing* system that accurately portrays *space opera* battle scenes from books and movies.

SOCS is not specific to *Lensman* combat — it covers many elements that the *Lensman* series does not, such as space-fighter combat. (The inertialess dreadnoughts of *Lensman* are every bit as maneuverable as smaller craft, much harder to damage and enormously more destructive — there's no *use* for fighters.) The details of using SOCS in a *Lensman* campaign are discussed.

Finally, some of the individual unarmed combat styles of Civilization are described for use with *GURPS Martial Arts*.

## ◎ SPACE OPERA COMBAT SYSTEM

SOCS requires a creative, imaginative GM and players. It does not lend itself to games theory min-max optimization. To the contrary, it even recommends that combat bonuses be granted for good roleplaying — which is an accurate simulation of the genre. A space opera hero wins because his hearts (however many he may have) are pure and he has *panache*, not because his craft has a tight turning radius.

In space opera combat, the emphasis is on fast-moving, exciting action. Realism is of secondary — if any — importance. The effectiveness of weapons and the durability of spacecraft can vary wildly, depending on whether or not an important character is involved. This is an important feature of the genre: consistency (and these rules) must never interfere with the action. For example, there is no *realistic* reason for a fighter ship to always have its nose pointed in the direction it is moving. It could *realistically* be moving one way, but turn sideways or even backwards in “flight” and fire its weapons in another direction. In *space opera* combat, this maneuver is impossible, and these rules, being an *accurate* simulation, do not allow it. (Explanation of the principles that make it impossible is left to the GM.)

Accordingly, even if they are flying identical ships, a minor character's craft is much more fragile than that of a major character. The slightest damage will obliterate a minor character's craft, but a minor character can never seriously damage a major one (unless the plot calls for a shipwreck). At most, small explosions jostle the main character and cause some sparks and smoke. Automatic equipment will usually die, forcing him to go to manual override. Kicking, swearing and cross-circuiting to ‘B’ will make the important systems function again.

Note that “major” and “minor” refer only to importance to the plot, not to which side of the conflict they are on. Good guys' and bad guys' ships also differ, but in a different way. Minor characters are all easily shot down, but while bad guys often explode into clouds of scintillating vapor at the slightest touch of a beam, good guys take longer to die, allowing their cries of “I'm hit, I'm hit!” to enrage the heroes and renew their determination.

Unless there are specific reasons to the contrary, good guys' ships are all white. Bad guys' are black or greenish-gray. Minor characters frequently have an inexplicable fondness for red shirts.

## Ship Classes

For purposes of SOCS, all ships are divided into three categories, each of which is handled differently in combat.

Craft with fixed, forward-firing weapons are classed as “fighters.” Their combat technique consists solely of maneuvering to bring their weapons to bear. They typically have light screens (if any) and no armor, relying on their small size and high maneuverability for defense. Usually they only have a single pilot and low endurance — missions are typically over in hours. Examples of this class are common: the X-wings of *Star Wars*, the Vipers of *Battlestar Galactica*, the “broomsticks” of *Footfall* and so on.

At the other end of the spectrum are the ships expected to bear the brunt of combat — the “ships of the line.” They mount many guns and projectors of various sizes as well as the strongest defensive screens and armor available. They are not necessarily clumsy and are seldom slow, but maneuvering is not particularly important in their battle tactics, since their multitude of weapon systems ensures that most can always fire. They simply allow their defenses to absorb hostile fire, rather than trying to dodge it. Periodically, the idea of the lightly armored, fairly maneuverable “speed is armor” battle cruiser recurs, but seldom works as well as its proponents wish. Ships of the line have crews in the hundreds or even thousands, and they undertake missions that last months or years. The battlestars of *Battlestar Galactica*, the star destroyers of *Star Wars* and the maulers and dreadnoughts of *Lensman* are of this class.

Between these two extremes are ships that mount several independent weapons, but are not powerful enough to participate in heavy combat. Their defensive systems will protect them against some damage, but heavy fire will overwhelm them fairly quickly. They are much more comfortable than fighter craft, but are not intended for long missions — their endurance is measured in weeks at the most. These “cutters” are much more maneuverable than ships of the line, but not as nimble as fighters. They usually have only a few weapon mounts, frequently identical. Any ship that must maneuver to unmask its weapons (*e.g.*, can’t fire to the rear without turning around) is considered to be in this class. Examples include *Star Wars’ Millennium Falcon* and the speedsters of the *Lensman* series.

Unarmed ships are also divided into three similar categories for purposes of combat — even though they can’t shoot back, their attempts to escape can be roleplayed. Small craft, intended to hold a few people and a little cargo for a short period of time are called “shuttles.” Very large unarmed ships are classed as “freighters” and those intermediate in size are called “yachts,” regardless of their actual use.

As with any grouping system, some examples are difficult to resolve. “*Star Trek’s*” various *Enterprises* have endurance of several months and are apparently among the largest ships in their universe, but they are under-gunned and weakly defended by most fleets’ standards. In these cases, the GM’s decision will be based on the desired game “feel.”

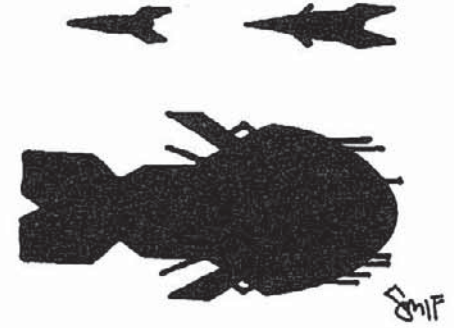

### “... in the event of a loss of cabin pressure. . . .”

How long does a character have to patch a hole? The rate at which pressure drops is determined by the volume of air present and the size of the hole. The time (in seconds) for pressure to drop to half its initial value is 4.3 times the volume of the air (in cubic yards), divided by the area of the hole (in square inches).

For example, a standard passenger cabin (20 cubic yards) is hit by a microscopic meteor, creating a one square inch hole. A passenger in the cabin has 86 seconds — nearly a minute and a half — before the atmosphere drops to *very thin*. From that point, he has only a few seconds left before being incapacitated; see p. S75.

However, a pressure suit has low volume: 0.03 cubic yards. A hole a quarter-inch across has an area of 0.05 square inches. As long as the suit’s air system can make up the losses, the pressure won’t drop, but 2.4 seconds after the air supply is exhausted, the suit’s pressure will be halved.

For a standard atmosphere to become

*thin* (0.8 standard): 1.4 V/A  
*very thin* (0.5 standard): 4.3 V/A  
*trace* (0.01 standard): 29 V/A

where V is compartment volume in cubic yards and A is the area of the hole in square inches.

Note that these numbers assume a Tellurian atmosphere at Tellus’ sea-level pressure and room temperature. Different compositions and pressures, and most especially temperatures, will result in different decompression rates.



## Kamikaze Attacks

Fanatic pilots or those in crippled ships that won't make it home anyway may elect to go out in a blaze of glory and plasma, ramming an enemy.

In most space battles, this gesture may be grand but not especially effective. Compared to the energies hurled by weapons systems and stopped by shields and armor, the kinetic energy of a ship is not significant. A 20,000-ton battleship ramming at one mile per second will cause only as much damage as a 6 kiloton atomic bomb. A 50-ton fighter, even at that speed, is trivial. If shields stop meteors and missiles, they will certainly stop rams.

(And ramming is only effective when both ships have inertia and thus kinetic energy. In a *Lensman* campaign, if either ship is "free," ramming is completely pointless.)

However, if the shields are down (or are ineffective against matter), the ramming ship should be considered an explosive weapon — all energy stored in its engines and weapons will be instantly released — with damage applied directly to hull armor. Fighters and cutters (and shuttles and yachts) will be completely obliterated. A large portion of a ship of the line (or freighter) will be obliterated, but the ship as a whole may be able to fight on, depending on the area of impact — and, of course, whether or not any major characters are aboard.

The many variables inherent in this situation make it ideal for a plot twist. If an NPC rams a ship containing player-characters, the PCs will probably survive, albeit trapped in a rapidly leaking derelict hulk with an unstable reactor that will soon overload. . . . On the other tentacle, if a PC rams an enemy ship, his last great act of defiance should be awarded by a dramatically stupendous explosion. On the third tentacle, it should be made clear that anyone who *chooses* to ram will certainly be killed in the crash. Ramming is not a standard tactic.

## Craft Ratings

Every ship of space has a *Maneuver Rating* (MR), an amalgam of several factors including the power of the ship's engines, the structural strength of its hull, the efficiency of its inertial or gravitational compensators, the design's angular moment, the acceleration tolerance of its crew and so on.

Every weapon mount is rated in Firepower, including not only its destructive power but also rate of fire. (This statistic is also used in the *GURPS Space* ship combat system.) A weapon's maximum effective Range is either "long" or "short;" a short-range weapon cannot hit anything at long range. Finally, a weapons system's Accuracy may be so good (or so poor) that the gunner's skill receives a bonus (or penalty).

## Damage

A single hit on a large ship rarely obliterates it utterly. The area hit may be vital, and some sort of chain-reaction may start that proceeds to damage more of ship, but the initial destruction will be fairly localized. However, because of the tremendous variety in ship designs, a generic hit-location system would be unwieldy. For purposes of SOCS, therefore, fighters have only one location and any heavy damage will cripple them, but cutters and ships of the line must be divided by the GM into several separate targets, each of which can be damaged without necessarily affecting others. For example, each weapon mount is a separate target; one turret can be knocked out, but others will continue to fight.

In SOCS, damage is divided into three levels (disregarding "none"). Because the range of available Firepower varies so widely from one universe to another, each GM must determine the expected range of Firepower for his universe, and divide that range to match the three levels.

If the total Firepower that hit a particular target in a single turn is relatively low, only "cosmetic" damage was done. Surfaces are charred and blistered, meters swing wildly, breakers open and are automatically reset, holes are punched in non-essential panels. If the GM desires, actual damage occurs that will not be apparent for some time — a fuel tank may be leaking, reactor shielding may be slowly degrading. The situation will not become critical until after the combat is over.

A total Firepower in the middle of the normal range does "light" damage. Fighters tumble briefly, small insulation fires break out, breakers arc over and spray the molten remains of their contacts across the compartment, an unimportant NPC is horribly maimed. *Continuing* damage of some sort also begins — a serious air leak, raging fires, poison gas release or similar. The target will complete this turn (since all action in a turn is simultaneous), but is out of action for the next combat turn and loses any accumulated bonuses. After taking that next turn for damage control and cross-circuiting to 'B,' the target returns to service in the turn following.

Firepower at the high end of the total range does "heavy" damage. Breakers weld themselves shut, then explode into huge fireballs. Fighters spin out of control



in flames, then explode. Large rotating equipment rears up off its mounts and tumbles about the compartment. Busbars burst in showers of molten slag. Raging fires break out, creating toxic smoke. Ammunition detonates in magazines. Nearly all minor characters are killed. After completing this turn, the target is completely *hors de combat*. The services of a tender or shipyard will be required to return the target to service.

Under special conditions, the total Firepower will do damage beyond the “heavy” range. “Great” damage results in the complete comminution of its target and everything surrounding it for considerable distance. Spaceships are annihilated by this level of damage, and GMs may have difficulty justifying the survival of any PCs.

Finally, for those times when foes should not just be dead, but really most sincerely dead, “stark” damage is possible. In this case, ships are not merely vaporized . . . the vapor itself is heated to fusion temperatures.

These damage results assume no protection, either armor or force screens. Fighters generally will have little or no such, but cutters might, and ships of the line certainly will. Protective systems vary too greatly for a generic system to describe fully, but they all have the effect of reducing the damage one or more levels. For example, a ship could have “ablative heavy armor” that stops light or cosmetic damage fully and reduces the first heavy hit to cosmetic, but is in turn reduced to “ablative light armor.” Now it stops cosmetic damage fully and reduces the first light hit . . .

## Inter-Ship Relationships

Ship-to-ship combat is divided into turns, representing a constant length of time, determined by the GM as appropriate for his universe. In many cases, a turn will be about ten seconds.

Distance and spatial relationships are also abstracted for the purposes of SOCS. Range is divided into three zones: short, long and “out of.” Every pair of ships has a range between them, but since most ships on a side will keep some kind of formation, it is usually sufficient to keep track of only a few distances. The GM will decide when the range between a pair of craft has changed.

Ships out of range may be able to detect each other, but they have no chance of hitting each other with their weapons. At long range, some weapons have a chance of hitting, but there is no way to improve that chance by maneuvering. All combat at this range consists of simple rolls to hit and dodges (see below). Most combat will take place at short range. All weapons can hit, and maneuver becomes critical for both offensive and defensive purposes.

A target’s size also affects marksmanship. Fighters, shuttles and other targets of that size do not modify the targeting roll. Targets smaller than that penalize the Gunnery roll by -1 or more at the GM’s discretion. Some targets — self-directing drones, for example, may also get a Dodge roll. Larger targets give bonuses. Cutters and yachts give +2 to targeting rolls, while ships of the line and freighters are +4 to hit. Still larger targets such as orbital fortresses and small planetoids are +6, while hitting a planet-sized target is automatic. Note that these numbers assume that the gunner is trying for a hit anywhere on the target. If he wishes to hit a particular point on the target the roll is modified accordingly. For example, a single gun mount on a planetoid-sized fortress is roughly fighter-sized. Generalized attacks on the fortress would be awarded a +6 to hit. Specific attacks on that mount would have no bonus.

The Gunnery skill roll needed to hit may get an Aiming Bonus (AB). A weapon without any AB suffers a -5 *snap-shot* penalty to the Gunnery roll. Two types of AB can be earned, and both apply simultaneously. Keep track of the *Position* AB earned by the pilot separately from the *Sustained Fire* AB earned by individual gunners.

A pilot earns a *Position* AB by positioning his craft well. It applies to all fire from his craft on a single target the pilot is maneuvering toward. Note that any weapons on his craft that cannot bear on that target cannot use this *Position* AB. The GM is the final authority on the spacecraft firing arcs.



## Precision Gunnery

Weapon’s Firepower ratings assume that they are being used more or less at random. If a gunner is familiar with a target’s layout, however, he can be much more selective in his targeting. He will do the same damage, but he will be much more efficient with it.

If a -5 penalty to Gunnery skill is accepted before rolling, all normal hits are handled as if they were critical, and critical hits are improved twice. That is, the level of general destruction remains the same, but the effect on combat is raised one or two levels. Thus, a hit that does light damage will still make only a small hole and only kill minor NPCs, but what it hits will be taken out of action permanently. That small hole went through something truly vital, not just a room partition.

## Turn Sequence

1. All weapons fire that can bear, and all ships dodge, all simultaneously.
2. All pilots chose maneuvers:
  - A. Fly Straight
  - B. Maneuver Offensively
  - C. Maneuver Defensively
  - D. Reversal
  - E. Go Totally Defensive
  - F. *Special*
3. Roll to perform maneuvers.
4. GM rules on effects of maneuvers — range changes, positions relative to hazards or other bodies and so on.

## Follow-the-Leader — or “You’ll kill us all!”

At times, a highly skilled pilot will find himself out-gunned by less capable foes and in imminent danger of being brought down by sheer weight of numbers. Fortunately, at such times there is usually a nearby “equalizer” that the pilot can use to turn a contest of firepower, which he would probably lose, into a contest of Piloting skill, which he expects to win. Asteroid fields, narrow winding canyons in planets’ surfaces, flare stars, dangerous nebulae and disintegrating planets can all be handy. This high-speed derring-do is most appropriate for fighters and cutters. Ships of the line have their own unorthodox techniques — see the sidebar on p. 109.

To initiate a follow-the-leader contest, the pilot simply heads for the hazard at high speed. His intentions are immediately obvious to his pursuers, and any that do not want to follow can break off.

Any that follow may continue to fire and Maneuver Offensively until their prey actually enters the hazard. Within the hazard, no standard maneuvers can be performed. Rather, after firing, everyone involved must make a Piloting skill roll every turn. MR still applies, but the pilot leading the chase may select any hazard level he desires (limited only by the GM’s ruling — this meteor storm may not be dense enough to allow more than a 5, for example). Both he and his pursuers then make their Piloting rolls with that penalty.

Each pursuer that succeeds may continue the next turn. A pursuer who critically succeeds gains +1 to AB. If he fails, he completely loses his quarry and cannot continue the attack.

If the pursued pilot makes his roll, the chase continues. If he fails his roll, all pursuers gain +1 to AB. If the pilot critically succeeds, *all* of his pursuers accumulate -1 to AB. Any pursuer with an AB of zero has lost his quarry and cannot continue.

Anyone who rolls a critical failure has made a spectacularly fatal mistake — collided with an asteroid, been immolated in a flare or whatever catastrophe is appropriate to the hazard.

The *Sustained Fire* AB is earned by gunners. Every turn after the first that a target stays within a particular gunner’s sights and he continues to fire at it, he gains +1 to his Sustained Fire AB. The GM will decide if this occurs — the limited firing arcs of many weapons make it easy for a highly maneuverable target to leave the cone of fire. Sustained Fire AB cannot be transferred from one weapon to another — if a target remains in one weapon’s cone of fire long enough for that weapon to earn a Sustained Fire AB, but it then moves into another weapon’s cone, the second weapon begins with no AB.

## Basic Combat

The simplest space battle consists of only two craft, matching skills and machines in unobstructed space. That pure contest is the situation described in this section. When more combatants join, and obstacles clutter the volume of battle, the resulting complexity is discussed below, in *Advanced Combat*.

A turn of combat has two phases — fire and maneuver.

### Fire Phase

In the first phase, a gunner whose weapon can *bear* can fire at his foe. To illustrate, consider a cutter shaped like a classic flying saucer with two gun mounts, one on top of its fuselage and one on the bottom. In the frantic maneuvering of combat it would not be able to maintain the exact edge-on attitude necessary for both mounts to be able to shoot at the same target at the same time. Roll against Gunnery skill, plus the weapon’s Accuracy, plus either that weapon’s current total AB or the snap-shot penalty of -5.

A failed Gunnery roll completely misses the target. Success is a hit and does damage appropriate to the weapon’s Firepower. The results of a critical failure vary from weapon to weapon, but some malfunction similar to those on the Firearm Critical Miss Table (p. B202) occurs. A critical success does the same damage as a normal hit, but the *effect* of the damage is increased one level. Thus a light weapon would still make a small hole, but it would be a small hole right through the engineer — and the heart of the generator!

Pilots can avoid incoming fire both by physically dodging it and by using counter-weapons such as point-defense guns and chaff to interfere with it. All of these techniques are included in a single Dodge roll that is the average of Piloting skill and the craft’s MR. A successful Dodge lowers the damage done by one level. All attacks and dodges are simultaneous. Note that Dodging has no effect on anyone’s AB.

### Maneuver Phase

During the maneuver phase of the turn, pilots choose one of these actions:

*Fly Straight* — or “You’re going to **WHAT?**” A pilot can always choose to fly a little slower and less aggressively. This maneuver has exactly the same effects as failure on a Maneuver roll. *Why* a pilot might wish to do such an apparently suicidal thing will become apparent later.

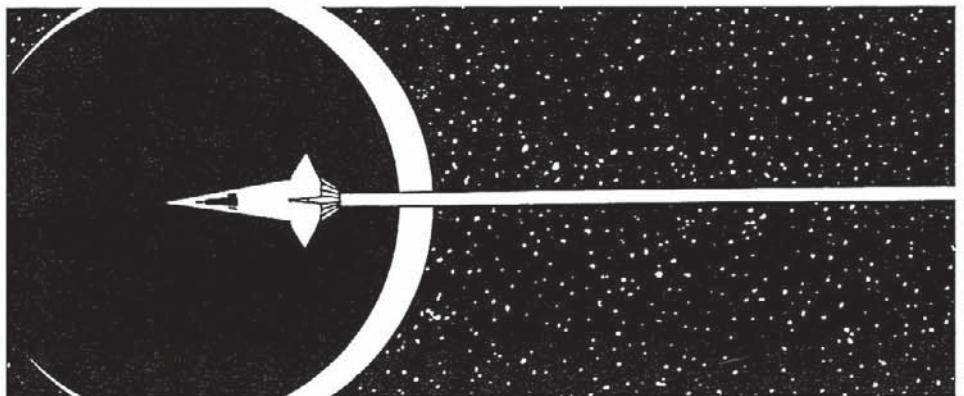

*Maneuver Offensively* — or “Ten more seconds and I’ve got the shot!” You can perform this maneuver against any target that does not have Position AB on you. Make your Piloting roll, plus the MR of your craft. Failure has no effect. If you succeed, your Position AB is improved a point. On critical success, your Position AB is *doubled* (or it is now 2 if you had none before). Critical failure means that you lost your quarry and everyone on your craft loses all ABs on that target.

*Maneuver Defensively* — or “One’s on your tail! Break high right!” Designate one enemy weapon mount or craft that you are defending against, and make your Piloting roll, plus the MR of your craft. All ABs earned by anyone on *your* craft are immediately lost. Failure on your skill roll has no effect. If you designated an entire craft, success reduces that pilot’s Position AB one point; if you designated a weapon mount, that gunner’s Sustained Fire AB is reduced a point. If your attacker’s Position AB is now zero, you can begin Maneuvering Offensively against him next turn. On critical success, you have lost your attacker, who now no longer has any ABs against you at all. If you critically fail, you have flown right into his sights. His Position AB is *doubled*.

If both sides of a pair Maneuver (both Offensively, or one Offensive and the other Defensive) and roll similar results (both succeed, both critically fail or so on), the ABs are unchanged. That is, if neither craft has any AB and both successfully Maneuver Offensively, no AB is gained and they can still only trade snap-shots next turn. If an offensive craft has Position AB +2 and Maneuvers Offensively while his foe Maneuvers Defensively, but both succeed, his Position AB is still +2.

A pure fight between well-matched opponents can last quite a while. If nothing is going to happen to break up the pattern of shoot-dodge-maneuver-maneuver-repeat — no one is going to run out of ammo or fuel, no one else is going to join in, no asteroid fields are handy — the GM may want to reduce the battle to a simple Contest of Piloting Skills. This pure situation should be rare.

## Cutter and Ship of the Line Combat

*Tactical was a sickly green as he slapped the communicator. “Heavy units inbound! Enemy axis zero-five-nine by one-thirty-two. Weapons free, all units maneuver to unmask batteries.”*

*The commander was remarkably calm for someone whose small force was about to be utterly overwhelmed. “Time to contact?”*

*“Raven will engage in . . . ninety seconds, Falcon in a hundred. Sir, we’ve been suckered!”*

*“No. We have drawn out enemy forces in this volume. That is the mission the Commodore gave us.”*

*The lieutenant’s disbelieving stare slowly faded as Commander Jones grinned. Behind them, the ESM panel flashed as Raven’s main batteries fired, their radiation pulses twisting space itself. “RAGE has engaged eleven heavy units,” the speaker crackled. “AVARICE is maneuvering to assist. Twenty-plus heading your way.”*

*“Evasive level three,” the officer of the deck ordered, a heartbeat before the sensor chief barked, “Snakebite! Snakebite! Gamma cannon, at least eight.”*

*Jones actually chuckled. “Beam weapons at three light-seconds! Eager little gorns, aren’t they?”*

*Lieutenant Tai turned back to the weapons panels. He had no idea what the Commander had planned, but he hadn’t earned his “Alex the Great” nickname for political maneuvering.*

*The Oglon, call-sign SLOTH, watched and waited, still and silent amid the radio roar of the gas giant’s ion-torus.*

Cutters or ships of the line are handled like fighters, with a few exceptions.

Cutters cannot get any Positional ABs on fighters nor can they dodge their attacks. Ships of the line cannot gain Positional ABs on fighters or cutters, nor dodge their fire.

## Unorthodox Tactics — or “Have you gone mad!?”

Out-gunned ships of the line usually cannot rely on reflex and maneuverability, but rather on some piece of knowledge that the pursuers lack. The fleeing ship does something apparently pointless: a variation on a well-known and easily countered tactic, a maneuver that is “well beyond the safety limits” of the ship or something outright suicidal.

The effectiveness of the maneuver is proportional to the amount of real jeopardy the ship is in. Role-playing the danger is important. The fleeing ship will take significant damage, with many system failures, exploding panels and at least a couple of NPCs dying in horrible ways. The GM will decide which ship personnel are using what skills, and require appropriate rolls. Success gives a large combat bonus for a few turns, but failure causes massive damage to the ship. Critical success results in the enemy’s total obliteration and critical failure annihilates the fleeing ship.

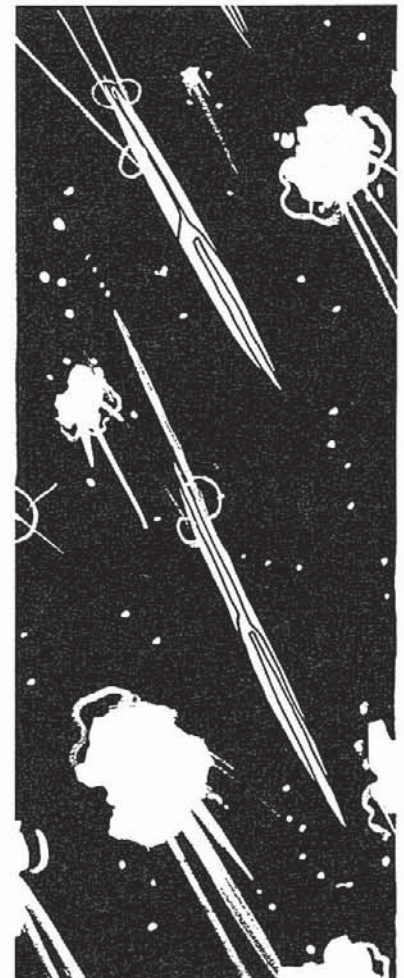



### The Furball

When several craft from each side meet, the battle never divides neatly into one-on-one duels. Instead, when one craft manages to acquire an AB on another, that one yells for help, a comrade begins to track that attacker, whose friends join in and so on. The result is a confused jumble of wildly jinking fighters exchanging snap-shots in which it is nearly impossible to identify the craft that has suddenly appeared right in your sights. The many crafts' exhaust trails form a distinctive tangled, glowing cloud — a *furball*.

In any engagement of more than half a dozen craft, when several entangled ABs have been established, the GM may declare that a furball has formed. In a furball, *any* critically failed Piloting rolls result in collision with a randomly chosen other craft. Also, *after* each snap-shot is resolved, the gunner must make a perception roll. On failure, he has shot a comrade.

Against other cutters or ships of the line, a cutter's pilot can use Offensive Maneuvering like a fighter to accumulate Position AB, and the pilots of ships of the line can earn Position AB against other ships of the line only.

Individual weapon mounts can always build up Sustained Fire ABs, but smaller craft are very likely to leave their cone of fire quickly, and GMs can rule at any time that such a Sustained Fire AB has been lost. Also, because the pilot and the gunners are not the same person, it is impossible for them to coordinate perfectly. If the ship's pilot Maneuvers at all, Offensively or Defensively, all gunners immediately lose all Sustained Fire ABs.

Ships of the line and, to a lesser extent, cutters are designed to take hits and continue fighting. The various armor and force shielding particulars must be determined by the GM. For a specific example of ship of the line and cutter combat, see the *SOCS in Lensman* section, p. 112.

The different capabilities of different ship types call for different strategies as well as tactics. Smaller ships' abilities to dodge may let them get in "under" heavy defenses where a ship of the line would be an easy target. A huge ship can take up station far from a planet and blast the surface, causing mass destruction while remaining largely immune to surface defenses. Smaller assault craft would have to actually work their way through those defenses, but may be more effective for "surgical" strikes . . . .

### Advanced Combat

Often a particular class of craft will have certain space combat maneuvers especially suited to it. These techniques cannot be described in detail in this general guide; individual GMs must decide what is possible in their universes. In general, a Piloting roll is required, often at a large penalty, but if it succeeds, any Position ABs involved are shifted in that pilot's favor. Failure results in a similar shift in the other direction. A common example of such a special maneuver is the Reversal.

*Reversal* — or "I'll hit the brakes, and he'll fly right by!" If you get an enemy of your own size or larger neatly trapped at your six-o'clock — giving him an uncomfortably high Position AB — you may be able to reverse the situation, and take his Position AB for your own. This maneuver is risky, with a real danger of instant annihilation, but it can save a situation just when disaster seems certain. A larger class craft cannot perform it against a smaller — *e.g.*, cutters cannot Reverse on fighters.

When a Reversal is announced, both craft immediately lose all Sustained Fire ABs. Both pilots roll against Piloting skill, plus their crafts' MRs — but the offensive pilot must *subtract* his Position AB! The closer he is to his target, the harder it is to follow a Reversal. If both pilots roll the same type of result (success, failure etc.), the situation is resolved like a Quick Contest — the one who succeeded by more (or failed by less) wins, and the results of a critical success on the appropriate Combat Maneuver, above, are applied. Either the defender has completely lost his attacker or the attacker's Position AB is doubled. If the attacker rolls a critical success and the defender doesn't, not only is the attacker's Position AB doubled, but all his gunners automatically hit in the next turn. If the defender rolls a critical success and the attacker doesn't, the former defender now has the former attacker's Position AB — the situation has exactly reversed. If either pilot rolls a critical failure, the craft collide and are destroyed.

When more than two ships are involved in a battle, the situation rapidly complicates. A lone ace will find that high skill is no longer the ultimate deciding factor when he is led right into the guns of his quarry's escort or wingman.

The clear distinctions of simple combat — offensive and defensive, head-to-head or chasing — are not completely lost in multi-craft combat. They are simply applied to pairs of craft. Each craft's Position AB applies to a single enemy, as does each weapon's Sustained Fire AB. More than one weapon or craft can accumulate ABs against a particular target.

If a gunner has a Sustained Fire AB, he can fire only at that target without losing the AB. If your ship has a Position AB against one target, gunners who fire at that target can add that AB. A gunner who is not also the pilot can fire at any target without affecting the ship's Position AB, but the pilot cannot fire at any target but the one he is maintaining a Position AB on.

Since a Dodge does not actually involve perceiving an incoming shot and deliberately getting out of its way, but rather consists of random jinking in the hope of throwing off someone's aim for a moment, a pilot may Dodge many shots each turn, rolling separately for each one.

A pilot can Maneuver Offensively against any single target, except a fighter that already has a Position AB against him.

Maneuvering Defensively affects the AB of only a single attacker. If more than one attacker has acquired an AB against your craft, you must designate which one you are defending against this turn. When this maneuver is used, your gunners lose any previous AB they may have had, though they can still take snap-shots.

To defend against multiple attackers, use Total Defense:

*Go Totally Defensive* — or “*Get out here! They're all over me!*” If several enemies acquire ABs against your ship, survival becomes problematical. Going Totally Defensive will only delay the inevitable, but it may delay it long enough for help to arrive. Any ABs your gunners may have acquired are lost, and they may not fire *at all* on the following turn. Make a Piloting roll. The results are the same as those for Defensive Maneuvering above, but apply to all attackers.

In multi-craft combat, the importance of wingmen or formations becomes obvious. While an enemy is lining up a shot on one pilot, the wingman can be lining up the shot on the enemy. The enemy cannot Maneuver Defensively without losing his AB against the first pilot, so either he will break off that attack or the wingman will get an easy kill. Ships in formation are not in danger of forming a *furball* (see sidebar, p. 110). If a formation is somehow very closely coordinated, as by the Z9M9Z *Directrix* of the *Lensman* series, a formation can fight and maneuver as a single enormous ship.

If four or more craft all get Position ABs on a single enemy that is their size or smaller, the single craft is said to be “boxed.” A boxed ship cannot make *any* maneuvers. It can only return fire and Dodge, and unless help is coming *fast* should probably surrender. Larger numbers can surround more than one ship at a time, but at least four times as many are required to do the surrounding as are surrounded. (And strictly speaking, twelve or more ships “englobe” their foe.)

## Inventing Maneuvers

Skilled pilots constantly “push the envelope,” trying out new maneuvers and combat techniques. Sometimes a genuinely useful trick is discovered.

GMs can allow player pilots to work out such maneuvers, particularly in a new design of craft, though it should not be made easy for them. The requirements should be arduous. Minimum skill levels to even start, large amounts of flight time, many skill rolls at a sizable penalty and the potential of a fatal mishap are all appropriate.

If the maneuver is allowed and successfully developed, it will give any pilot who knows it a bonus against any opponent who doesn't, as well as having some special effects. The exact amount of the bonus and nature of the effects are left to the GM's discretion, but some factors affecting them include the skills of the developing pilots, the magnitude of their successes in the development process and the quality of the name they give their technique. (Simply descriptive names such as “split-S” are worth less than metaphorical ones like “scissors” or “cobra.” A character's reputation will determine whether or not he can get it named after himself, like the “Immelmann.”)

The value of a new maneuver decays rapidly over time, as the enemy sees the maneuver and both adopts it and learns to counter it. In pitched warfare, with several battles fought every day, a maneuver's “half-life” may be as short as a week; *i.e.*, in a week, its value is cut in half, in two weeks, to a quarter of its original and so on. Round down. It will soon reach zero.

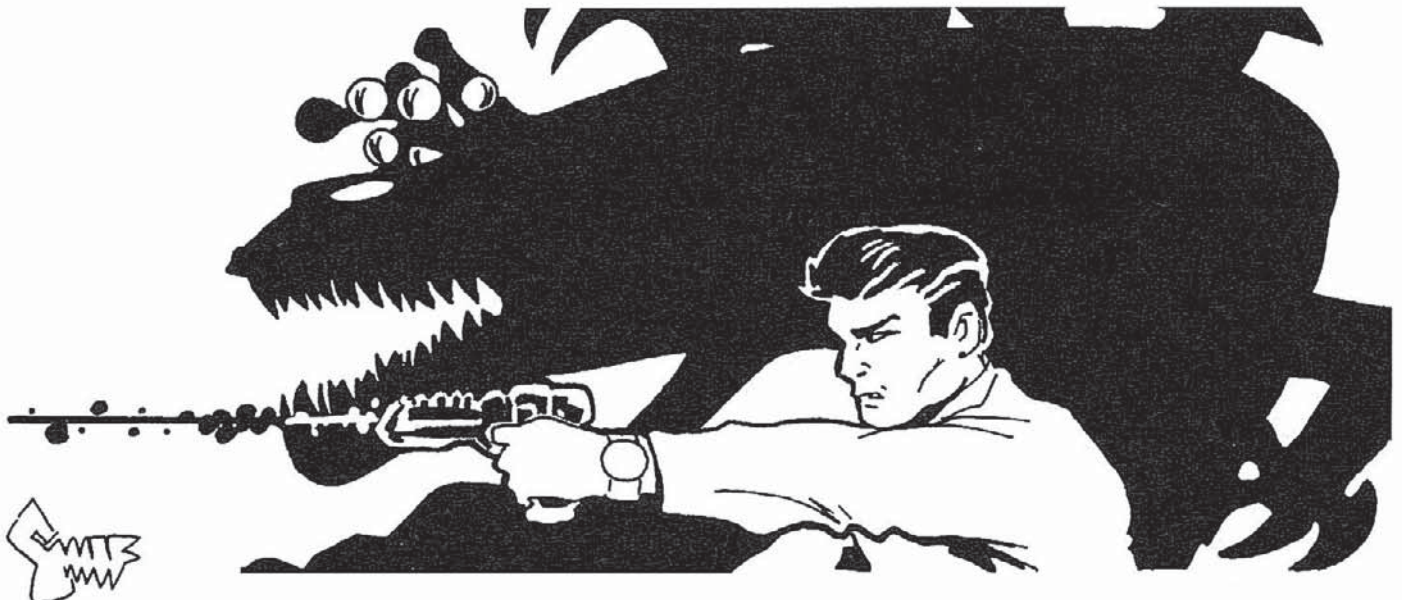



## Battle Stations!

All fighters and shuttles, many cutters and yachts and a few freighters with very small crews operate with every station always manned. Ships of the line, though, cannot. Weapons stations are exceedingly boring when there's no one to shoot at, and the crew is too small to provide frequent reliefs. Readiness quickly begins to decline.

Accordingly, under normal conditions, ships of the line operate at *standard* readiness. If the captain suspects that trouble may be eminent, he can place his crew on *Alert*. When trouble actually begins, the crew is ordered to *Battle Stations*.

A crew at standard readiness cannot fire any weapons, and all damage their ship suffers is one level worse, since most hatches are open, the damage control stations are not manned and so on.

It takes two minutes for a human crew to go from standard readiness to *Alert*. Once on *Alert*, the ship no longer suffers the increased damage penalty, but can only fire half of its weapons.

It takes three minutes to go from *Alert* to *Battle Stations*. At *Battle Stations*, the ship functions at full capability.

The GM should let the PCs play out these times, with modifiers for where in the ship they begin relative to their battle stations, their knowledge of the ship, their Running skills and so on. Once a particular weapon mount is manned, it can fire regardless of the rest of the ship's readiness.

*Battle Stations* cannot be manned indefinitely. After six hours, the crew begins to tire and alertness begins to decline. *All* rolls made by a human crew are penalized by one for every hour over six at *Battle Stations*. *Alert* can be held longer; rolls are penalized one for every four hours over a full day of *Alert*.



## ◎ SOCS IN LENS MAN

The invention of the Bergenholm inertialess drive so changed ship-to-ship combat as to make it utterly unrecognizable to captains of any previous era. To begin with, it rendered explosive weapons such as missiles obsolete, since a "free" ship would simply be flicked away by the first puff of gas or fragment from the explosion. Therefore, the objective of combat is to hold energy beams on the foe long enough to burn through his defenses, while preventing him from doing the same to you. The Bergenholm makes this goal difficult, as well, since beams travel at the speed of light, and ships move much faster. Also, a "free" vessel will be pushed away by the pressure of the beam that is trying to damage it! Accordingly, attackers must lock themselves to their victims with tractor beams in order to do any damage at all. Since tractor beams have relatively short range, battles take place at ranges measured in tens of miles. Weapons are designed for use at these ranges — in SOCS, all *Lensman* weapons are considered short-ranged.

### Ratings

When using SOCS in *Lensman*, a Firepower of 500 or less or a screen with Defensive Factor (DF) of 10 or less is considered light. Firepowers from 501 to 1,500 and DFs from 11 to 30 are heavy, while great Firepowers are between 1,501 and 5,000 and great DFs are between 31 to 100. Firepower greater than 5,000 is starkly destructive and DF greater than 100 is starkly refractory.

### The Battle

The first goal in engaging an enemy ship is to acquire tractor lock on that ship. A ship that is not grappled by tractors is essentially invulnerable; the slightest touch from matter or energy flicks it away at many times the speed of light. (*Extremely* powerful energies may still damage a "free" ship — see sidebar.)

Tractor lock is acquired by a successful roll against Gunnery (Tractors), using all the standard SOCS guidelines. Each tractor lock must be separately attacked, since tractor shears may be used to break such locks. Tractors can only "hit" ships at short range.

Once tractor lock is acquired, if either ship was "free," they instantly close until their meteor screens touch. If both are "inert," they accelerate toward each other at the sum of the ratings of all locked tractors.

Ships that are tractored together cannot Maneuver. Their gunners can get Sustained Fire ABs, but neither can get a Position AB against the other.

Once the target is anchored, it can be attacked. In *Lensman*, all ships are protected by force screens, since no matter can withstand the energy levels applied by weapon beams. When using macro beams, critical hits are irrelevant and precision gunnery is useless as long as screens are functional. One point on the screen is a good as any other for the purpose of overloading that screen. Any successful Gunnery roll simply adds that weapon's Firepower to the screen's burden. Needle beams powerful enough to punch through the screen still benefit from accurate placement, however.

### Screens

Screens are rated as having light, heavy, or great ability to absorb incoming Firepower. As they do so, they gain in *Coruscation Levels* (CL). For every CL a screen gains, its color shifts up the spectrum: red to orange to yellow to green to blue to indigo to violet. If a screen gains an additional CL after reaching violet (seven CLs) it overloads, shifting through the ultraviolet to black before its generator burns out and provides no further protection.

A screen provides little protection in the turn that it burns out. Whatever is inside a screen as it collapses takes damage from every weapon that hit the screen, one level less than usual. If three heavy macro beams all hit a lightly screened ship in the same turn, that screen will burn out. If that was the last screen protecting that ship, it will suffer three separate "light" damage results.

While a screen is functional, it re-emits absorbed energy at a rate of one CL per

turn. A ship can and usually does mount multiple screens. Screens are affected in order of increasing DF — a more refractory screen surrounds a physically smaller volume. Inner screens cannot radiate at all until outer screens have shed all their absorbed Coruscation Levels.

## Macro Beams

		Screen Defense Factor			
		Light	Heavy	Great	Stark
Macro Beam Firepower	None	Radiate	Radiate	Radiate	Radiate
	Cosmetic	0	Radiate	Radiate	Radiate
	Light	+1	0	Radiate	Radiate
	Heavy	+3/Light	+1	0	Radiate
	Great	Down/Heavy	+3/Heavy	+1	0
	Stark	Down/Great	Down/Great	+3/Great	+1

Cross-reference the macro beam's Firepower with the target screen's DF. A "0" means that the screen does not gain any CLs, but cannot radiate any, either. "+1" or "+3" gives the screen that many more CLs, and a damage name means whatever is inside that screen takes that level of damage. "Down" indicates that the screen instantly collapsed. A screen that gets *only* "Radiate" results in a turn will shed one CL level at the *end* of that turn.

## Needle Beams

		Screen Defense Factor					
		Light	Heavy	Great	Stark	Cosmetic	None
Needle Beam Firepower	Cosmetic						
	Light			Light	Heavy	Great	
	Heavy		Light	Heavy	Great	Stark	
	Great	Light	Heavy	Great	Stark		
	Stark	Light	Heavy	Great	Stark		
Screen Coruscation Level	None	Stark	Heavy	Cosmetic	—	—	—
	Red	Stark	Great	Light	—	—	—
	Orange	Stark	Stark	Heavy	Cosmetic	—	—
	Yellow	Stark	Stark	Great	Light	—	—
	Green	Stark	Stark	Stark	Heavy	Cosmetic	—
	Blue	Stark	Stark	Stark	Great	Light	—
	Indigo	Stark	Stark	Stark	Stark	Heavy	Cosmetic
	Violet	Stark	Stark	Stark	Stark	Great	Light



Needle beams — needlers and primaries — are concentrated rays that cannot raise a screen's CL. They either penetrate or are stopped, as determined by both the screen's DF and current Coruscation Level.

To use the Needle Beam Table, look up the weapon's Firepower along the upper-left edge, and read across to the target screen's DF. If the target's DF is off the chart, no damage is done. Now cross-reference that column with the screen's current Coruscation Level to find the maximum damage that can get through the screen. The actual damage done is the lesser of the beam's Firepower and the level indicated. For example, if a light beam hits a light screen that is currently violet, the table indicates stark damage. However, a light beam can only do light damage.

The beam strength of "Cosmetic" appears, not because anyone would mount a weapon only capable of scorching some paint, but because that can be the remaining beam strength after penetrating an outer screen.



## Damaging Inertialess Objects

"[A]s is of course well known, it is under any ordinary conditions impossible to wreak any hurt upon an object which is both inertialess and at liberty to move in space. It simply darts away from the touch of the harmful agent, whether it be immaterial beam or material substance."

Vastly powerful energies *can* damage an inertialess and untractored ship; the few molecules present even in intergalactic space offer some slight resistance to movement. If a free ship is attacked, divide the attacker's Firepower by the speed divisor found in the Gazetteer (Chapter 4), and by another factor of 100. For example, the *Dauntless* is in the inner edge of a spiral arm, attacking an inertialess Boskonian. Its primaries are rated at a Firepower of 200,000, but that number is divided by 1 for the local density and by 100, giving 2,000, or "great" Firepower. If the Boskonian's "heavy" screen is already coruscating yellow, he will take "great" damage and be utterly destroyed.

## Example of Lensman Combat

The hospital ship fled, filling the ether with cries for help. The pirate's engines closed the gap quickly and a tractor flicked out. The hospital ship's pilot was good; again and again he dodged that grasping tentacle of force, but the final result was unavoidable. Locked together now, the pirate inerted and went to work.

The pirate mounts a heavy Firepower macro beam and a light needler. The unarmed hospital ship has a light outer screen and a heavy wall-screen.

In the first turn, the ravaging macro beam claws at the outer screen. Cross-referencing a heavy macro beam with a light screen indicates "+3/Light." The screen flashes through the red and orange, and is now blazing yellow. The light damage that gets through is stopped by the heavy inner screen.

The macro continues with a pyrotechnic display that fills all of circumambient space with high-tension sparks. The screen flashes past yellow, past green and blue and hangs at indigo, flickering frantically. Again, the inner wall-screen stops the light damage that gets through.

The pirate's needle-gunner, eager to claim the hostages, fires his needler. A light needler against an indigo light screen gives a result of "stark." The penetrant shaft of force is unhampered by the overburdened screen, and punches through. The still-refractory heavy inner screen stops it cold, however. The macro beam blasts the outer screen through the ultraviolet and into the black and, barely hindered, smashes crunchingly against the inner screen. The heavy wall-screen begins glowing a dull red as the heavy macro beam drills into it.

The needle gunner realizes that his light weapon cannot penetrate that adamant wall of force—yet. He impatiently waits the few seconds necessary for the macro beam to heat the wall-screen to a flaming green. He then goes to work. His first shot is a trifle premature. With the screen only green, he can only do "cosmetic" damage to the ship. Beginning the next turn, though, light damage can be done through the eye-searing blue-indigo-violet of the screen. The needler stabs and stabs again, ravaging the bridge and the mighty engines.

As the screen begins flashing violet, the pirate captain orders the macro beam to fire only intermittently, allowing the screen to cool between shots. By firing every second turn, the screen can be held in the indigo. The needler is doing its job, and if the screen should fail under one of the macro's shots, the hospital ship will be heavily damaged. The nurses are only of value alive; the ship must be forced to surrender.

*Continued on next page . . .*

## ◎ MARTIAL ARTS

*Board and storm!* No matter how sophisticated technology becomes, it is not always available. Nor, when prisoners must be taken, either to extract information or for ransom, is it appropriate to vaporize the foe.

This section contains additions to the rules in *GURPS Martial Arts* and *GURPS Martial Arts Adventures*, which are required to make use of them.

### New Maneuvers

**Non-Striker Blow (Special)** *Roll vs. Karate, Brawling or Boxing. Cannot be improved. Prerequisites: A limb without a striker.*

Any limb can be used to strike a blow. If that limb is not a specific striker like a claw or a horn, it can still do Thrust-2 damage plus skill bonuses. Swiftly coiled tentacles, suddenly straightened, propel their tips to high speeds. Wings are powerful appendages, as are tails. Tentacle snaps, wing buffets, tail sweeps and so on are all the equivalents of punches, and are all treated exactly like the Hand Strike (see p. MA40) of a bony-limbed fighter. Most other hand maneuvers have their tentacular counterparts; the tentacular Whip-Crack corresponding to a Roundhouse Punch (see p. MAA109) and so on.

Any style with Karate, Brawling or Boxing as a primary skill has the Non-Striker Blow maneuver at no extra cost.

**Striker Blow (Special)** *Roll vs. Karate, Brawling or Boxing. Cannot be improved. Prerequisites: A limb with a striker.*

A limb evolved to strike does more damage than one not so intended, of course. Intelligent beings can learn to use such limbs even more effectively than instinct provides. The basic damage is that of the striker, e.g., thrust/crushing for a plain striker, thrust/impaling or swing/cutting for short claws and so on. Add to that damage standard Karate, Brawling or Boxing bonuses. Because strikers are evolved for specific uses, this maneuver has fewer variants than Non-Striker Blows.

Any style with Karate, Brawling or Boxing as a primary skill has the Striker Blow maneuver at no extra cost.

**Wing Baffling (Average)** *Defaults to DX-2. Cannot exceed prerequisite skill. Prerequisite: Wings*

Wings can be used to distract and blind opponents, in a manner similar to a feint. The amount you make your Wing Baffling roll by is subtracted from your foe's active defenses next turn.

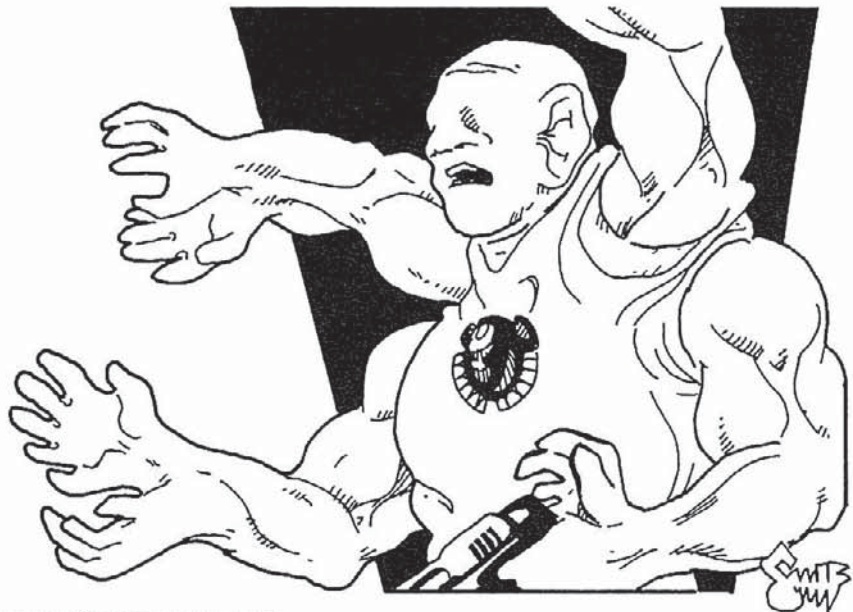

## **Donganeur (Hard)**

### **Defaults to Karate-2 or Brawling-2 Prerequisites: ST 20+, and Karate or Brawling.**

The Tomingan *donganeur*, or “flying roundhouse,” is an effective technique for very strong humanoids. It is a powerful punch, thrown during a headlong dive for the foe. With it, a fighter can reach any opponent within standing or running broad jump range (see p. B88).

A Jumping or DX-4 roll is first required. If successful, roll against *donganeur* skill. In any case, roll against Acrobatics-4 or DX-8 to avoid falling, taking 1d-2 crushing damage for every two yards you traveled. All your active defenses are at -4 during this maneuver, and this is the only attack you can make during the turn, even if using Multiple Attacks.

A *donganeur* does swing+2 damage, with Brawling or Karate bonuses. Damage is doubled for purposes of calculating knockback and knockdown.

## **Flying Head Butt (Average)**

### **Defaults to Karate-2 or Brawling-2. Cannot exceed any prerequisite skill+4. Prerequisites: Head Striker, and Karate or Brawling.**

The flying head-butt is a combat technique used by many races with head strikers such as horns.

If you hit with a Flying Head-Butt, your victim will take damage proportional to your weight. The basic damage is your trample damage (see p. B142); the type is determined by your type of skull. Round, bony skulls do crushing damage; other strikers can cut or impale. This damage is doubled for each 10 Move, halved if you are moving 3 hexes per turn or less. Knockback and knockdown are determined as for a normal slam.

For example, a 1,500 pound Velantian tramples for 1d+1. Flying at a Move of 40, he can head-butt for 16d+16 (crushing). Should a being without a head striker attempt this maneuver, he takes the same damage as his target, to his head.

First, you must resolve a slam attack (see pp. B112-113). On a miss, you continue to move past your target; roll against Flight-4, Acrobatics-6 or DX-10 to recover. If successful, then roll against your Flying Head Butt skill. On a failed skill roll, take half base damage to the head. If you hit, your target takes full base damage of the type of your striker; *e.g.*, if you have an impaling horn, the damage is impaling. All your active defenses are at -4 against this maneuver, and this is the only attack you can make during the turn, even if using Multiple Attacks.

When butting bulkheads or a solidly braced victim, double the damage done (or taken, on a missed roll). No preceding slam attack is necessary in this case.

## **Styles**

This section describes several new martial arts styles for use in a *Lensman* campaign.

### **Military Hand-to-Hand Combat 18 points (No Cinematic Abilities)**

The officers of the Galactic Patrol, like those before them of the Triplanetary and Solarian Leagues, are highly trained in the vicious science of hand-to-hand combat. They don't fight for pleasure or sport or rich purses, but when they enter combat without weapons, they fight with one sole purpose — to kill, as quickly as possible.

The fighting skills taught at the Academies are based on the ancient Tellurian art of *savate*. Its emphasis on flexibility and attacks with the more-powerful legs apply to weightless conditions well, and its tradition of cane fighting translates to the use of the space-axe. Inertialess combat also requires the addition of limb-locks to the repertoire.

*Primary Skills:* Free Fall, Karate, Space-Axe, Vacc Suit.

*Secondary Skills:* Acrobatics, Brawling, Climbing, Inertialess Agility, Judo, Knife.

*Optional Skills:* Knife Throwing, Stealth.

*Maneuvers:* Back Kick, Close Combat, Elbow Strike, Eye Gouging, Head Butt, Hit Location, Jump Kick, Knee Strike, Kicking, Spin Kick.

## **Example of Lensman Combat (Continued)**

*The pirate's communications officer failed to intercept the reply to the hospital ship's maydays. He could not fail to notice, however, the sudden scream of static as all ether and subether was filled with intense jamming by the on-rushing mauler. Frantically, the pirate pilot cut the tractor, smashed all the control keys for his hot driving jets into their last stops and snapped the Berg back on-line. The pirate sprang away at nearly 70 times the speed of light.*

*The chase was brief. The ship of the line had far more legs than the cutter, and ran it down in short order. Tractors flashed out, the pirate dodged and spun, one finally snapped on — and was promptly cut. But the brief instant was enough for two others to lock on, and the mauler mounted more tractors than the pirate had shears. While one was cut, two others were attaching.*

The pirate mounts three courses of screens; two heavies inside a light. The mauler has four heavy screens, four heavy macro beams, two heavy needlers and six light needlers.

In the first turn, the pirate fires both his weapons. The macro spits and scratches against the heavy screen, but can barely raise a dull red glow. The needler thrusts out but is turned and shattered by the rigid defense. The ravaging beams of the mauler's macros all leap out together. The pirate's light outer screen is instantly raised twelve levels of blinding coruscation and collapses. The heavy middle screen blocks the four “light” remainders.

The second turn, the glow of the mauler's outer screen reaches orange. The pirate's middle screen, though, is heated from nothing to green.

The third turn, the mauler's outer screen reaches yellow and the pirate's middle screen collapses.

The fourth turn, both the mauler's screen and the pirate's wall-screen are green, and the mauler's heavy needlers begin their precise work. They can do full damage through the badly weakened wall-screen. Patrol Intelligence has learned the layout of this type of ship, and one needler does light damage to the screen generators. For the next turn, the screen goes down.

In that turn, the mauler inflicts six heavy damages and six light. The pirate's riddled, lifeless hulk drifts away as the mauler releases tractors and returns to aid the derelict hospital ship.

**Thuleschlag**  
**(Jovian Adept Combat)**  
**7 points/41 points**

The Adepts of North Polar Jupiter were founded by Gharlane of Eddore, and were patterned in many ways after his very successful "brotherhoods" within the inner circles of Germany. However, the Jovians proved to be considerably more reliable than the self-indulgent poltroons his Hitler persona attracted, and Gharlane revealed to them far more than he had to the Nazis.

The disciplines learned by the Adepts are, in martial arts terms, "internal" techniques, and so are of limited use at novitiate levels. A fully-ranked Adept, however, is an exceedingly dangerous opponent. Many abilities attributed to the Adepts by rumor are now supposed to have been lost when their headquarters was reduced by multiple asteroid impacts at the end of the Third Jovian War.

Three sets of Cinematic Skills are listed below. The teachings of the Adepts were rigidly limited by rank — all lower tier skills must be learned (at least one full point each) before any higher may be studied. Meditation and Mental Strength are listed in each set — at least one point must be put into each at each tier.

*Primary Skills:* Judo, Meditation, Philosophy (Vril — Eddorian propaganda), Space-Axe.

*Secondary Skills:* Beam Weapon, Body Language, Breath Control, Karate, Yin/Yang Healing.

*Optional Skills:* Muscle Reading.

*Maneuvers:* Arm Lock, Close Combat, Neck Snap.

*Cinematic Skills I:* Blind Fighting, Immovable Stance, Kiai, Meditation, Mental Strength, Pressure Points, Push.

*Cinematic Skills II:* Body Control, Invisibility Art, Meditation, Mental Strength, Power Blow, Pressure Secrets, Blinding Touch.

*Cinematic Skills III:* Hand of Death, Meditation, Mental Strength.

*Cinematic Maneuvers:* Enhanced Dodge, Roll with Blow, Sticking.



*Special:* Normally, vacc suits or space armor give a -1 to all DX-based skills and DX rolls. This training includes combat-familiarization, which eliminates the penalty to all combat-oriented rolls and the Free Fall and Inertialess Agility skills. The cost is 4 character points.

**Space Marine Hand-to-Hand Combat**

**21 points**  
**(No Cinematic Abilities)**

As efficient as officers' standard combat training is, it is intended for use in emergencies only. A trooper expecting to do battle regularly is given far more extensive skills.

Space Marine hand-to-hand training stresses brutal efficiency. Marines *can* capture prisoners, but their primary mission is to close with and *destroy* the enemy. If anyone escapes, he should tell a tale of such horror that no bifurcate race hearing it will ever willingly face the Marines in combat.

The Corps prefers warriors from the many races adherent to Civilization that have natural combat-oriented advantages such as high ST and bodily strikers.

*Primary Skills:* Free Fall, Inertialess Agility, Judo, Space-Axe [2 points], Vacc Suit.

*Secondary Skills:* Acrobatics, Karate.

*Optional Skills:* Stealth.

*Maneuvers:* Aggressive Parry [2 points], Arm Lock, Close Combat [2 points], Eye-Gouging, Head Butt, Head Lock, Hit Location [2 points], Neck Snap.

*Special:* The Marines are also given combat-familiarization with vacc suits and space armor, identical to that described above.

**Tsudo (Velantian Combat)**

**10 points/23 points**

"The art of claw and fang," or *tsudo* as it is known to speaking peoples, is a wide-spread discipline on Velan. It has many variants and differing schools, and comparing them is a popular pastime. Usually no permanent injuries are inflicted, and Velantians heal quickly.

*Tsudo* emphasizes simultaneous attacks with multiple limbs and using the wings as diversions. Grappling is studied but discouraged, because Velantians are too flexible to make locks practical. Instead, it is limited to holding an opponent still while another limb strikes.

One weak point of *tsudo* is its disdain of artificial weapons. Velantians' natural weapons are so formidable that they frequently fail to appreciate the fearful potentialities of, say, a space-axe.

*Primary Skills:* Acrobatics, Flight, Karate

*Secondary Skills:* Performance

*Optional Skills:* Telepathic Illusion

*Maneuvers:* Aggressive Parry, "Corkscrew" combination [4 points]: Tail Constriction and Tail Striker Blow (see below), Flying Head Butt, Wing Baffling.

*Cinematic Skills:* Power Blow.

*Cinematic Maneuvers:* Enhanced Dodge (only when flying, for 12 points)

The "Corkscrew" combination: If a Velantian successfully grapples with his tail, he can use this combination in the same turn to automatically hit with his tail-blade for swing/cutting damage while simultaneously doing constriction damage — if the victim loses a contest of ST, he takes as much damage as he lost by.

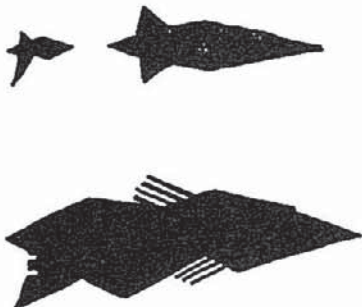

# CAMPAINS

## CHAPTER EIGHT





### Cinematic Play

If you aren't, you're not doing it right. QX, that's an exaggeration. It is possible and quite fun to run a "low-level" Lensman campaign, featuring non-Lensed characters caught up in the war. There are many, many more non-Lensed Patrolmen than Lensmen. See the adventure seeds for some ideas.

A campaign, though, will naturally tend to develop a more "free-wheeling" tone, where the parsecs whip by, in the thousands per hour.

There is another extreme, however. One of its warning signs is a tendency to swear by Klono's polyester leisure suit. Another is overuse of adverbs: pointing out that it is getting *starkly* close to dinner-time. If these signs persist, it is possible that you have found yourself in a Silly Game.

The culmination of a two thousand million year old battle for freedom is not to be taken lightly. Civilization is a tolerant entity, but use of any of the following Silly Rules calls for the lethal chambers.

#### Bulletproof Nudity

PCs can increase PD by undressing. A dramatically torn shirt is PD 3; stripping to the waist is PD 5; total nudity is PD 7. These are +1 for female PCs, and +1 for redheads (cumulative). Special *skin-tight* vacc suits are available for females that do not penalize DX.

#### Infinite Ammunition

PCs always have spare ammunition or power cells; if they shoot up all they are carrying they immediately find more. Their weapons only run dry during a pause in the action. Related to this is infinite functionality; their equipment never malfunctions in any way.

*Continued on next page . . .*

A *Lensman* campaign is rather different from the common science-fiction campaign. Lensmen are far more powerful than the usual adventurers, and the only limit on a Gray Lensman's actions is his own conscience. Players accustomed to the lack of any moral sense in other worlds may find the genuine honesty of the Lensman a challenge to play.

## ● FORCE, DRIVE, SCOPE, RANGE, POWER . . . BUT ABOVE ALL, ABSOLUTE INTEGRITY

These are the qualities of a Lensman. They are also the qualities of a *Lensman* campaign. While every action of the player-characters may not affect the largest scales of the entire Boskonian War, the importance of the struggle should not be forgotten. The struggle is between Good and Evil, for the fate of Civilization.

The characters caught in that conflict can come from any background, but those in the books have several commonalities. They are intelligent, educated, expressive, positive and gracious and honest. They do not believe that "average" is better than "elite" and are unashamed of their superior knowledge or intellect. They do not confuse the ideal of "equality under the law" with equality of ability or even potential. Rather, they knew with certainty that humans — that all beings — are intrinsically *unequal*. They have force, drive, scope, range and power, and are not afraid to use them.

But above all, they have absolute integrity. Patriotism and duty are integral parts of a true member of Civilization. They keep their word. They don't shirk. They pay their debts. They are loyal, both to their friends and comrades and to any other adherent of Civilization. Boskonian propaganda may state as obvious that any civilized entity must be a pacifist, may urge self-proclaimed intellectuals to sneer at patriotism, may promote contempt for the military. The beings of the Galactic Union know better. Back-stabbing and betrayal have no place in Civilization.

In their own way, Eddore and Boskone have their integrity, too. They aren't melodramatic villains, tying the captured hero to a railroad track, twirling their mustachios, and then leaving so that the hero has a clear shot at escaping. Such a stupid Boskonian would be eliminated by his own side long before he had a chance to be an asset to Civilization.

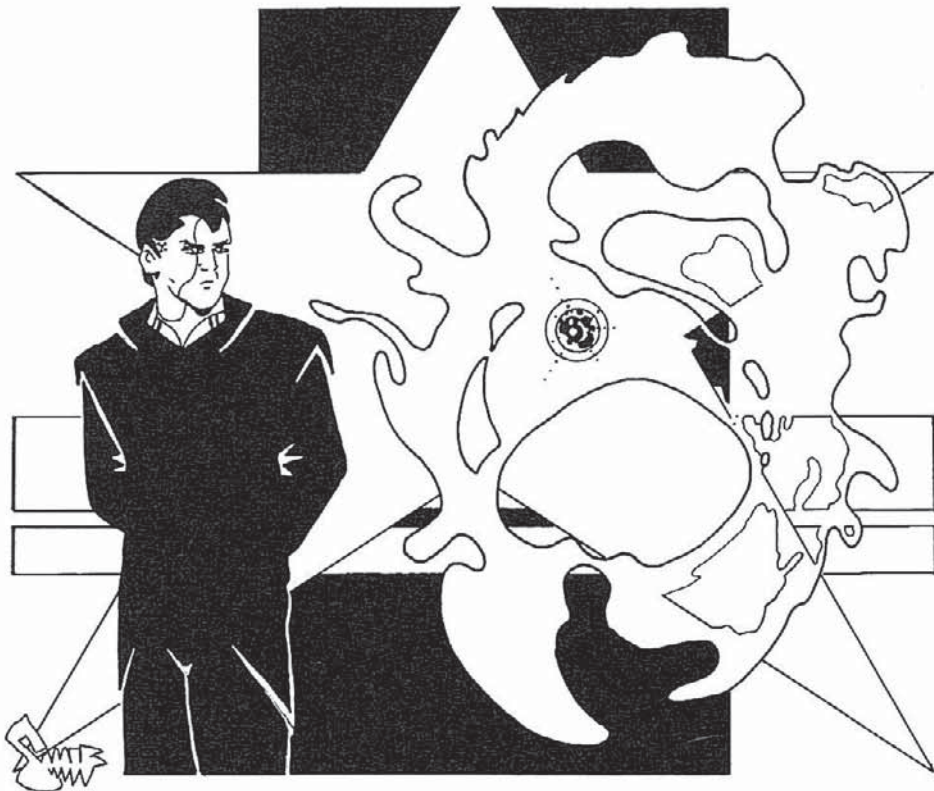

If a Boskonian captures a Galactic Patrolman, he is very likely to shoot the Patrolman out of hand. The war is one of extermination, of genocide. Neither side is interested in prisoners. Boskone will torture ranking Patrolmen for information, of course, but again, it will done in an efficient fashion. Similarly, Patrolmen will turn Boskonians over to Lensmen for mind-reading — and then, it's the lethal chambers.

## ● VILLAIN-DRIVEN PLOTTING

One way a GM might try to give a role-playing session the satisfying feel of a well-plotted adventure story is to prepare fully the plot he wants to involve his players in, then shoehorn the characters' actions into his predetermined plan, herding them back on course when they "go astray." Published scenarios frequently adopt this strategy, since their authors cannot take into account the unique characters used by each playing group.

The problem with this scripted approach is that it has the appearance of adventure tales while ignoring the mechanism that drives them. A basic principle of contemporary Western fiction is that action should arise out of character. Scripted play presents a story-line that exists independently of the main characters. Although the result might seem tightly structured, the players may feel more like spectators than participants.

Accordingly, GMs have been urged to construct plot-lines around the player characters, whose goals should drive the story-lines. They are told that they "should not" combat player boredom by throwing endless varieties of new creatures at them every session and that they "must not" allow the accumulation of vast quantities of loot. Players are required to submit detailed character biographies and psychological analyses, in the hopes that such exercises will force the creation of vivid and entertaining characters.

This approach requires tremendous flexibility and improvisational ability from the GM, who must invent plots only as the players think of something to do. The GM can prepare little more than an idea of what's waiting in the woods and hope that the party can find trouble on its own initiative. It also demands a frequently impossible level of creativity from the players. Those with demanding "real-world" lives have neither the time nor the energy to devote to detailed character analyses, and inexperienced players are frequently taken aback and even become slightly panicked when the GM says "tell me about your character." The result is frustration — they came to have fun, and found themselves taking pop quizzes in improv acting, composition and psychoanalysis.

This "character-based" approach also relies on the analogy that a good role-playing game is like a Western-literature novel. The similarity is slight, however. A novel has a definite ending, and many role-playing campaigns go on indefinitely. A novel also centers on a single character (at one time, most often for the entire book). The other players in a campaign are likely to get bored at too much development of any single character. If anything, a role-playing campaign is more like an episodic television series with an ensemble cast. The plots of most episodes of such series do not arise from one particular character's personality — the same problems could have developed and been handled just as well by another character of different capabilities and personality. The *handling* of the problems would be different, but the adventures do not *arise* from the characters.

Various compromises between these two extremes exist, many featuring reams of "common knowledge" notes that a newcomer to the campaign must learn. Another approach can be taken, which has most of the strengths of the former styles, but which does not suffer from any of the weaknesses. "Villain-based plotting" gives players clear goals without strait-jacketing them into a linear script. It puts the requirements for creativity on the person best capable of meeting them: the GM. And it creates, almost automatically, a vivid, evolving world for the characters to live in.



## ***Cinematic Play (Continued)***

### ***Jerry-Rigs***

PCs may improvise anything they need out of the materials in their pockets. At particularly dramatic moments, they find have everything they need *except* one-point-eight ounces of unobtainium . . . drat! Of course they immediately find it in a nearby passing comet.

### ***Imperial Stormtrooper***

#### ***Marksmanship Academy***

Opposing forces never hit with the first shot or burst of automatic fire. It always lands close enough to the PC that he is aware he is under fire, but never does damage.

### ***Exploding Eyeballs***

The facts of decompression are ignored in favor of graphic gore. At the smallest pin-prick, NPCs burst into messy clouds of tomato paste. PCs, of course, are tougher, and survive long enough to patch the leak or don spacesuits.

## ***Clint's DeLameter?***

*I squint at him and snarl, "This is a DeLameter, the most powerful raygun in either galaxy. It won't just starkly vaporize your head clean off your body, it will annihilate most of the wall behind you. So if I were you, I'd ask myself the question, 'Do I feel lucky?' Well? Do you . . . zwilnik?"*



## Balance

Many game texts stress the need for “balance” — ensuring that anything that improves a character’s effectiveness is inseparable from handicaps that all but eliminate that effectiveness.

In a *Lensman* campaign, however, balance is not particularly important. Entire planets are being destroyed! GMs who want to maintain some control over the lethal capabilities of the players may want to disallow *Ultra-Tech* weapons modifications, for example — dureau super-fine space-axes with vibro mono-wire blades may be a bit much — but does it really make a difference? In a *Lensman* campaign, the characters are not necessarily the most powerful entities around — non-Lensmen certainly aren’t! Even if they have Lenses, they are merely *possibly* equal to the task facing them; even Second-Stage Gray Lensmen can be over-matched, captured, tortured, maimed. Don’t begrudge them a character point or two . . . or even a dozen. Likewise, don’t demean the importance of the struggle by sending them incompetent opponents.

Lensmen also have a built-in handle a GM can use to “balance” them any way desired — the Lensman’s Load. At any time, the GM should feel free to tell the player of a Lensman that his actions don’t live up to the standards of the Load. A Lensman does not use his power for personal gain. He doesn’t read everyone’s mind as a matter of course because that would be rude. Each Lensman draws his own line over which he will not trespass, but the GM can also enforce limits. Has a Lensman accumulated too much money? His duty forces him to spend it all on something that benefits Civilization — but not him, in any way that affects the game. Too many powerful allies? He may have to sacrifice them for the greater good. Lensmen will *not* violate their code. It is starkly inconceivable that Mentor would give a Lens to anyone who could violate it; a player can no more have his character do so than he could destroy a Lens. It is simply not possible.

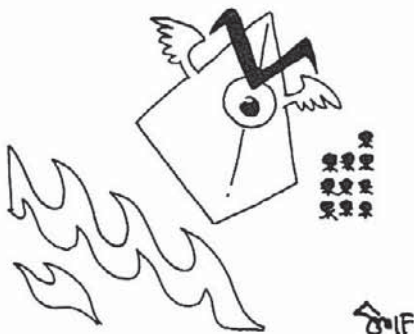

To implement this style, the GM concentrates on creating strong, colorful villains, along with their nefarious plans. It is essential to this style that the villains *want* something — kidnap the princess, conquer the world, whatever. (This development is unnecessary for cannon-fodder, obviously. The motivations and plans of the guards that the adventurers will slay on the way into the stronghold are irrelevant.) Then the GM plans out, in rough, the progress of the villain’s plan under the assumption that the player-characters do nothing. The “adventure” is now ready to begin.

During the course of play, the GM sees to it, as subtly or as blatantly as necessary, that the PCs learn of the fiendish plot. The players, however, are left free to decide whether they want to get involved or not. If they don’t interfere, the plot proceeds around them and may involve them willy-nilly (when, for example, martial law is declared). Note that the plot may fail even without the party’s assistance! They are not the only force in the world — the regular army may be sufficient to beat back the forces of evil, though their losses may be high.

The players’ free wills are thus unhindered. They are allowed to follow their characters’ own desires, if they have developed them. On the other hand, a beginning player, unsure of what he *can* do, is given a clear goal to seek, although the exact path to it may not be obvious.

This method of play is especially appropriate for the universe of the Lens. Gray Lensmen cannot be given orders — they cannot be called into the Coordinator’s office and told “go do this.” They are, however, given every bit of intelligence data available and are expected to act on it. Their own consciences will not allow them to do otherwise. *How* they act on that data varies wildly from Lensman to Lensman, and to shoehorn the party into one particular approach to a mission is not appropriate to this genre.

## ● VIEWPOINT

A *Lensman* campaign can begin at a number of different viewpoints. If the players haven’t read the *Lensman* series, the GM can place them in the position of the officers of the early Galactic Patrol: utterly unaware of the sheer magnitude of the opposition, believing that they are fighting only a well-organized band of pirates and drug-pushers. They should be encouraged in this mistake. No member of Civilization except the five Children of the Lens ever became aware of Eddore. Even Kimball repeatedly underestimated Boskone’s extents. Then, as the intrepid players defeat rank after rank of pirates and zwilniks, they find another layer, and a layer behind that, and another behind that, until they have attracted the attention of the Overlords, of the Eich, of Kalonia, of Onlo, of Ploor itself.

However, if any of them have read the books, this approach is not possible, and they will have the appropriate level of respect for the task facing them. In this case, GMs should bear in mind that Boskone is a *conspiracy* of intergalactic extent as well as a military opponent. Their soldiers may salute their officers, and their warships may be readily identifiable, but their spies and smugglers and pirates and drug-runners do not wear uniforms. Boskone has infiltrated nearly every aspect of life. Its agents are subtle, intelligent and highly trained. Regardless of how much the player knows about Eddore from the books, he may know nothing at all of the particular tentacles of corruption he is currently facing. Only an infinitesimal fraction of Boskone’s structure or operations were described in the *Lensman* series. An excellent time period in which to set a campaign including such players is discussed below, in *The Spawn*.

## ◎ TIME PERIOD

The *Lensman* series covers thousand of years of Tellurian history. A campaign could be set at any time — an Imperial Rome adventure could be part of a *Lensman* campaign. However, the space-opera “feel” of the novels seems to require a space-faring setting — and there were no Lenses before the formation of the Solarian League!

### The Triplanetary and Solarian Leagues

The early history of Civilization included many interplanetary conflicts. Tellus, Mars and Venus allied quickly, but the peoples of the Jovian Subsystem were much more recalcitrant, and Gray Roger fanned that tension into four open wars, in each of which the Adepts he trained nearly destroyed the young Triplanetary League. In other stellar systems, the Velantians were losing a psychic war with the Overlords of Delgon, the Palainians were beginning interstellar flight . . . only the Rigellians were at peace. This setting is ideal for GMs who want total creative control over their campaign — little is written about this time period that the players will be able to read. However, the Lens was unavailable before the end of this period.

### The Galactic Union

After Gray Roger was finally destroyed and the Triplanetario-Nevian War ended, humanity began to take a major part in galactic affairs. They soon incorporated not only the Nevians and the various humanoids of Bennett, Cavenda and other similar planets, but the alien races of Palainians and Rigellians into the Galactic Union. This period is an exciting time of exploration. Heavy piracy action is interspersed with clashes with hostile natives, some of which are simply xenophobic while others are adherents of Boskonnia.

### The War

The Boskonian War officially begins with the fall of Helmuth’s Grand Base, when the communication lines are traced to the Second Galaxy. The Galactic Union finally realizes that it was not simply suffering a long and powerful crime wave, and begins to shift to full-scale war. This change affects every aspect of society. Particularly at first, while industry is changing over, shortages occur. When there are shortages, there is profiteering and black-marketeering. Police forces begin to treat the zwilniks they haul in from the streets with a new attitude — maybe he’s just a punk kid, or maybe he’s our lead to enemy agents . . .

This period lends itself to the widest range of plots, from the straight-forward military mission to undercover infiltration. Every war-story ever told can find a counterpart during the Boskonian War.



### *Arisia and Eddore*

GMs are frequently cautioned that NPCs don’t know everything. GMs of *Lensman* campaigns should ignore this caution. Mentor’s Visualization of the Cosmic All and the computer-aided predictions of the All-Highest of Eddore are correct in all macrocosmic details, save for some of the actions of third-level intellects who are trying to be unpredictable — such as Mentor and the Innermost Circle of Eddore.

However, omniscience and near omnipotence does not imply any amount of benevolence. Mentor is absolutely dispassionate. He is engaged in a breeding project of millions of years duration, to create the next Guardians. He is interested in only the details that affect the final outcome. At certain extremely sensitive moments, Mentor takes direct action, but every one of those moments directly involves a Second-Stage Lensman, and are of a nature such that if Mentor did not intervene, Civilization would be proximately destroyed. In all situations less crucial, Mentor will be uninterested. A Lensman may be in a situation that will certainly result in his death if Mentor doesn’t help. Mentor will state, “Youth, your inexcusably loose and muddy thinking got you into this; get yourself out” and then watch to see if the Lensman does. If he dies, he wasn’t worth saving. Mentor allowed the millions of deaths of the sinking of Atlantis. Mentor allowed the thousands of millions of deaths in the Tellurian World War. Mentor would have allowed the deaths of Kimball and Clarrissa — after the Children had been born — had Christopher not compelled his assistance.

The Innermost Circle of Eddore is less sympathetic. Any wavering of performance, any slightest fault of reasoning, any report less than utterly complete and inevitably conclusive results in immediate punishment. For trivial shortcomings, a being may simply suffer removal of all privileges and authority. If any harm results from a lapse, the being is removed from this plane of existence. This system has its shortcomings, but it does ensure that those opposing the forces of Civilization will be very experienced at not making mistakes . . . or not getting caught.

## The Lens Across Genres

### Space, Aliens, Psionics, Ultra-Tech

These books are obviously appropriate to Lensman campaign, although any equipment that requires transistors or integrated circuits of any kind must be reworked to use ultra-microminiature vacuum tubes, and anything involving automatic computers should be prohibited.

### Special Ops

The basic ideas of this book apply perfectly to the Galactic Patrol — Lensmen are the most special of all special forces. The descriptions of the 20th-century organizations are useful only by analogy, but the missions have not changed at all. Lensmen and other highly skilled troops carry out strategic reconnaissance, strategic strikes, combat rescues and every form of paramilitary insurgency and counter-insurgency operations imaginable.

### Espionage

The Boskonian War was fought not only with ravaging beams and stilettos of irresistible force but also with the lock-pick, the camera and the stiletto of steel. The so-called “undetected war” was waged on every planet where Civilization and Boskonian came into contact, and was no less deadly for all its subtlety. Subterfuge, sabotage and seduction can entangle Lensmen as well as more mundane characters. Boskone, and Eddore behind it, are supremely intelligent foes and are masters at working behind multiple layers of cut-outs. A Lensman can read minds, but the minds he encounters could be deceived innocents, themselves tricked into leading him away from his goals and into a deadly trap.

### Illuminati

It is very, very difficult to completely exterminate a conspiracy. Even after Eddore is destroyed, eradicating every root and branch of the Spawn of Boskone will be all but impossible. Driven underground, the conspiracy will spread, grow and mutate into a million pathological power structures. Even a Lensman’s mind-reading ability is of no help when the pawns and the Beings-in-Black have no idea — or false ideas — for whom they work. Mentalities of less than the second level of stability are not cleared for further information. Fnord.

*Continued on next page . . .*

## The Spawn

The War ends with the fall of the Thrale-Onlonian Empire. However, an intergalactic culture takes time to die, even when it’s been decapitated. The severed tendrils of the Boskonian web — the “Spawn of Boskone” — continue to harry Civilization for over twenty years more.

This period is another exciting time of discovery. Only the most insignificant fraction of Lundmark’s Nebula has been explored. Millions of myriads of planets that never knew anything but the dominion of Boskone await their first contact with Civilization. Some will welcome their liberators, but others will continue hostilities. Back home, the infiltration networks are still in place, and people are still buying drugs. The job is far from over, but popular support is waning fast. “There’s no more zwilniks! They surrendered, didn’t you hear?”

This time period is ideal for campaigns with players who are familiar with the books — it is appropriate for their characters to know that Boskone was (is) a real threat. They can get entangled in vast plots, as the seeds of the final conflict develop, but they will not be big enough to bring in the Second-Stage Lensmen.

## Peace

Finally, even the “evil effluvium” that inspired the Spawn is eradicated, and Civilization is at peace. QX. No menace can develop beyond the smallest, most local level. Of course, Kinnison believed that Helmuth was the kingpin of the pirates. Then he was certain that the destruction of Jarnevon destroyed Boskone. He was convinced that the fall of Thrale and Onlo ended the threat. Eddore was the top of that particular pyramid, but . . . who finds Christopher’s flask of force?

It is undisputed that the *Lensman* series is unfinished. Doc’s daughter, Verna Trestrail, and Frederik Pohl confirm Robert Heinlein’s comment that Doc had at least one more book plotted. Doc told the story and its ending to Heinlein, who commented that it was unpublishable at the time, and that it develops inexorably from clues in *Children of the Lens*.

But as Heinlein says, that’s Doc’s story to tell. You’ll have to tell your own.

## ● ADVENTURE SEEDS

### 100 Points — “Citizen of the Galaxy”

The ships arrived without warning. Both the Union of Peoples’ Democratic Republics and the Republic of United Democratic Peoples immediately attacked with atomic rockets, but the warheads detonated harmlessly ten miles away from the ships. Harmlessly to the ships, that is. The electromagnetic pulses from the high-altitude explosions fried many fragile pieces of electronic equipment around the world.

The invaders told us that they had permitted that as a demonstration of futility. Then they vaporized the missile sites with beams of force, and summoned the world leaders to their flagship. Then they summoned their successors, and then most of *their* successors. Then a few more successors. Eventually, every country in the world surrendered. We were now a productive part of the Empire of Boskonian.

Actually, not all of us were productive. In fact, some of us were starkly counterproductive. At first we flailed around a bit, talking about a “campaign of resistance” but working more by whim than with a master plan. Which is not to say we were ineffective. We sent a “Continental Proconsul” and a round half-dozen “Tribunes” on a quick trip to the next plane of existence, along with caterers, band and female entertainers. Irritatingly enough, the new Proconsul seems less eager to throw big parties. And Amalgamated Electric’s Fotunder atomic pile won’t be making any more weapons-grade plutonium for at least a couple years.

Nonetheless, we weren’t very efficient until this new guy showed up. He doesn’t look like anything special — tan, rough hands, creased face, maybe a little on the chubby side — except his eyes. Folks on the street, when you can see their eyes, are all beaten. No life left. And us, we’ve all gotten a faintly desperate look to us. He’s neither. He looks like a bird of prey just starting to get hungry. No name, but then most of us don’t have names either. Calls himself “Star A Star.”

"Thornhill," he said. I just looked at him, trying to look as much like lightning waiting as he did.

Hayman's not as patient as me. "The big antenna station. What about it?" he snarls.

"That big dish can pick up anything for a ten thousand parsecs around."

"Sern droppings. I know a guy working there. That thing'll never work. Someone musta altered the plans. The freqs are all wrong."

He just raised an eyebrow. "It's already working. What makes you think it uses radar?"

Hayman opened his mouth, then closed it again.

"Sometime in the next month or so," he went on, "a fleet's going to be passing nearby. If Thornhill's still working when it does, it's going to have some trouble. It'll win, but it'll do considerable damage to this place doing so. Are you guys up to taking it out? If I get some plans for you?"

"You get us plans," Savonne said, "we'll make it a gravel pit."

"Actually, I was hoping *you'd* help me with another project. You see, I've been invited to the Admiral's Ball, and I need a date. I thought it would be a good time to ask him a few questions and then kill him. Do you dance?"

## 200 Points — "Galactic Patrolman"

The sign on the door reads "Director, Fleet Astrographic Survey Agency." You've had one short interview with Admiral Hume when you reported to this base, a newly minted ensign fresh from the Academy. Sasha jogs up just as you turned the corner.

"You too?"

"The whole division's here."

"Bog. What's happening?"

You shrug.

Some Rigellian in a tailored gray harness stands behind the Old Man's desk. "Now that we're all here," the Admiral says, "I'm just going to turn you over to Unattached Lensman Tregonsee. He's running this show."

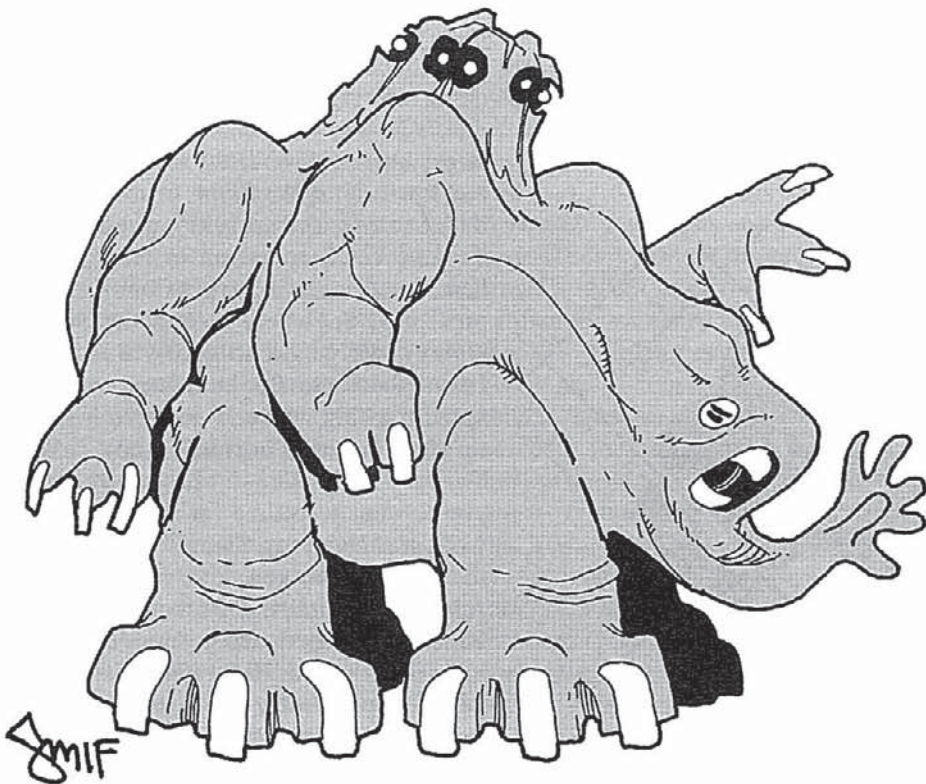

## The Lens Across Genres (Continued)

### Fantasy

A Second-Stage Lensorc? Why not? The war between Arisia and Eddore is simply one theater in the multiversal war between Good and Evil. A fantasy campaign could easily be built around the idea that the Force of Good needs help, and so breeds its successors and endows them with an instrumentality . . . the Lens. The various races are already present. Perhaps the "power of the mind" being developed by this Mentor is Magical Aptitude instead of telepathy, but that detail changes little of the fundamental plot.

### Cyberpunk

Without transistor technology, bionics becomes quite problematic and automatic computers do not exist, so the most of the cliches of cyberpunk — body-machine blending, virtual reality, hacking — are not possible. However, a world that has just been liberated (conquered), by either side, will have ruined, half-empty cities, shell-shocked refugees, intrigues between the collaborators and the conquerors, bandit-infested desolate areas, a seemingly unfeeling military machine poised to crush anyone in its way. . . .

Even more appropriate are the nihilistic punk attitudes — that life is cheap, drugs are good for you as well as fun, all authority (especially government) is automatically stupid and corrupt and *everyone* is evil — if you're playing a Boskonian.

Enjoy it while you can. *This* government is neither stupid nor corrupt, and has resources that no one else can match. And when the Lensman shows up, don't bother trying a Fast-Talk roll. He can read your mind; he is absolutely incorruptible; he is judge, jury and executioner . . . and you're a zwilnik.

## Theme Music

Gaming sessions, especially those with action-packed climaxes, benefit from appropriate theme music. Obviously the sound-tracks to any space-opera movies such as *Star Wars*, *Battlestar Galactica* or *Flash Gordon* are appropriate, as are many of John Carpenter's works (especially the theme from *Halloween*) and Alan Parson's instrumentals.

Many modern electronic works — various pieces by Vangelis, Jean-Michel Jarre, Tangerine Dream and others — also have the right tone. *Interstellar Suite* by Amin Bhatia is highly recommended.

The more grandiose classical works should not be overlooked. "O Fortuna," from Orff's *Carmina Burana*, Wagner's "Ride of the Valkyrie" from *Die Walküre* and the "Mars" movement of Holst's *The Planets* are cliché, of course. Tchaikovsky's "1812 Overture" is very good for the clash of large space fleets, while Beethoven's "Wellington's Victory" works better for fire-fights on the ground (if one can avoid singing "The Bear Went Over the Mountain" or "For He's a Jolly Good Fellow" to the "Marlborough" theme).

You can hear the jaws hinges popping around the room. The first Gray Lensman any of you have ever seen is Tregonsee himself!

"Thank you." His telepathic "voice" is deep and sonorous. "I apologize for 'usurping' your command, Admiral, but it is necessary. I understand that your recent gravitational mapping survey of the halo of the Second Galaxy found an anomaly in a satellite cluster."

"Ah, yes, I, um, found a . . ." Janis trailed off, flustered.

"Please speak aloud. It clarifies your thoughts," Tregonsee gently requested.

"Hrm. Yes. In halo cluster one twenty-four seventeen plus eighty-one, I detected strong gravity waves, amplitude on the close order of seven solar masses, frequency . . ."

"I've read your report and everyone else here who hasn't, will, soon. There is no luminous object nearby, is there?"

"Nothing big enough, not for two arc-seconds."

"For some time, I have had reason to believe that a substructure of the so-called Spawn of Boskone meta-organization is developing a weapon — a super-tractor, if you will — that uses extreme gravitational forces to warp space to the extent that nothing, not even light, can escape."

"*Chornye zhopy!*"

I glared at Sasha and Janis flushed, but if Tregonsee understood the Russian obscenity, he elected not to notice. "Yes," he agreed. "A black hole. A singularity in the space-time continuum that could swallow a fleet or an entire planet. Obviously, the Boskonians will be working under extreme secrecy, but your special knowledge and skills will track them down. I realize that as scientists, none of you are line officers, and are not authorized to serve in combat positions. Our mission is to locate the Boskonians' research facilities and learn what we can, then summon the fleet to destroy it. I will exert every effort to ensure that you will not come into contact with any enemy forces."

## 400 Points — "Lieutenant Lensman"

"Siddown, Lieutenant, and don't salute me again. The Coordinator told me to brief you and to provide you with "every assistance," and that feels like you outrank me in spite of my forty-three years and these little starbursts.

"Kush 937 II, Lieutenant — "Land," to its natives. Little enough to recommend it. A bunch of dinky nation-states busy doing nothing but splintering even smaller, all at war with each other. A couple larger ones with ballistic atomic weapons and low-orbit space flight. In short, utterly defenseless and quickly gobbled up. Trouble is, it's one arm in from Klovia here. In other words, to get from Klovia to purl' near anywhere else in the Second Galaxy, we've got to get by this Kush-Land place. So Boskone's got a deep-space tracking network, centered here, on this mountain. Thornhill, they call it. There's a local resistance movement you'll want to utilize for diversions and what-not. Now, my Signals man tells me that nine to thirteen days from now one Admiral Labemills, a Boskonian slightly-big-shot, will be touring Thornhill with a huge honor guard. He's rated strictly a target of opportunity, definitely not worth jeopardizing the primary mission for. Now I strongly recommend that you wait until he's gone, but it's your option.

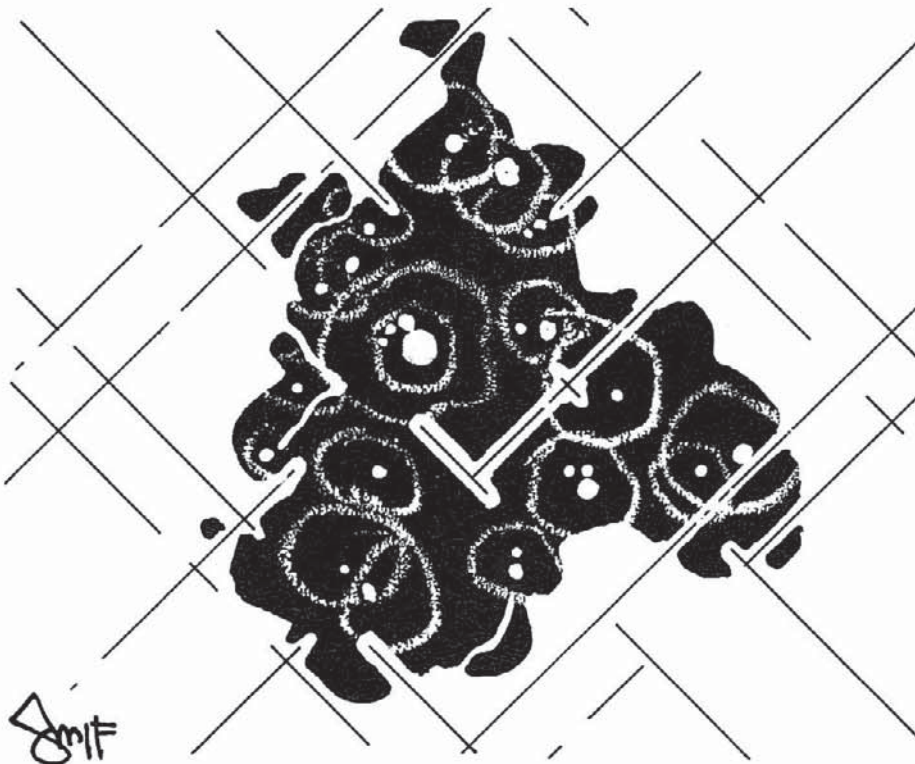

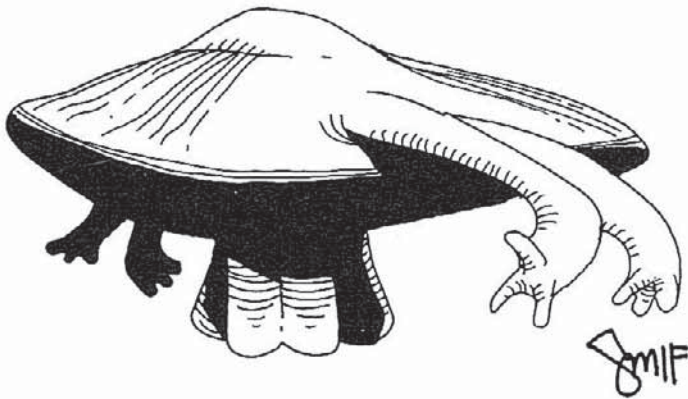

"That's what I hear, Lieutenant. I was just hoping that you wouldn't let that "always go in" stuff endanger the mission. But I've got my orders, and they say give you a free rein. You've got your team picked out?"

## 1,000 Points — "Unattached"

*Something's going on. The planetaries each think it's a local problem, but it's all through the cluster, and that makes it the Nebular Coordinator's problem. Not the Galactic's — Kinnison's got his own rows to hoe and he doesn't like being bothered by local problems. Oh, he wouldn't say anything! He still signs his memos "if in doubt, do not hesitate to call," but a Coordinator who does call better be inviting him out for lunch, or reporting the Second Coming of Boskone! So the buck stops right here, in a big ugly stinkin' pile right in the middle of the Nebular Coordinator's desk.*

*It looks like just more of the usual. The designer drug du jour, maybe. Except no drug was ever this insidious. And that report from Strauss! Something about a helmet . . . "better than thionite." Strauss' last report.*

Eukonidor watched the Coordinator re-read the report. He knew Strauss' fate, and he knew that while the ultimate goal had already been achieved — the Ultimates had been conceived and born — this moment was nonetheless crucial to the future of Civilization. It would determine much of the environment in which the new Guardians would mature.

Thionite's seductiveness is its granting of *all* desires. Its drawbacks are high price and extreme toxicity. Eukonidor's Visualization, while not as complete as a Watcher's, predicted the team of Onlonian psychologists and psionics, together with Eich engineers, that developed a replacement: a psychotronic device which plumbs the most depraved depths of a subject mind, coupled to a incomprehensibly sophisticated electronic automatic computer, crafting a broad-band, full-sensory hallucination in which all those lusts are fully gratified. It causes absolutely no physical harm to the user, and best of all, it *records* those lusts and their gratification . . . for future reference, if it becomes desirable to influence the subject.

The satisfaction of working and struggling for incomplete compromises cannot compete with complete and total *instant* gratification of every desire. Arisia interdicted the development of automatic computers — "thinking machines" — because of their obvious stunting of mental growth. Boskone, of course, prefers to avoid the mental growth of its subject races. Even though it causes absolutely no physical harm, if every trace of this device is not eradicated, the fundamental fabric of society will be destroyed, replaced by a self-indulgent pseudo-world, a "virtual reality."

*QX. This thing . . . helmet, gizmo, whatever, is spreading like fission, and the idea itself is all it takes. It can't be kicked up, and if Strauss, with all his skill and experience, is lost, it sure as all nine of Palain's purple hells can't be kicked back down. But it's got to be smashed, total and quick. It's all the Coordinator's mess, all right, but there's nothing saying the Coordinator can't use all his resources.*

*"Pam, I want messages sent to every one of the Gray Legion who aren't up to their respective sensory organs in something. Coordinator's respects, all that, and request they stop by at earliest convenience. I've got a project I'd like some help on."*

*It'll be good to get out of these formals. The Gray still fits.*

## "Guardians of Civilization"

TO YOU WHO HAVE SCANNED THIS REPORT, FURTHER GREETINGS:

*Since I who compiled it am only a youth, a Guardian only by title, and hence unable to visualize even approximately either the time of nor the necessity for the opening of this flask of force, I have no idea as to the bodily shape or the mental attainments of you, the entity to whom it has now been made available.*

*You already know that civilization is again threatened seriously. You probably know something of the basic nature of that threat. While studying this tape you have become informed that the situation is sufficiently grave to have made it again necessary to force certain selected minds prematurely into the third level of Lensmanship.*

*You have already learned that in ancient time civilization after civilization fell before it could rise much above the level of barbarism. You know that we and the previous race of Guardians saw to it that this, OUR civilization, has not yet fallen. Know, now that the task of your race, so soon to replace us, will be to see to it that it does not fail.*

*One of us will become en rapport with you as soon as you have assimilated the facts, the connotations, and the implications of this material. Prepare your mind for contact.*

—Christopher K. Kinnison



# BIBLIOGRAPHY

## E.E. "Doc" Smith

### The Lensman Series

*Triplanetary*  
*Second-Stage Lensmen*  
*First Lensman*  
*Masters of the Vortex*  
*Galactic Patrol*  
*Children of the Lens*  
*Gray Lensman*

### Other Stories

*Spacehounds of IPC*

### Lensman Stories by Other Authors

#### David A. Kyle

*The Dragon Lensman*  
*Lensman from Rigel*  
*Z-Lensman*

#### William B. Ellern

"Moon Prospector," *Analog Science Fiction/Science Fact*, April, 1966.  
*New Lensman, Perry Rhodan* #61-75, January-June 1975; London: Futura, 1976.  
 "Triplanetary Agent," *Perry Rhodan* #100-105, August-October 1976.



"HYA  
 BOSKO!"



JOCKEY  
 JOE JR.

JMF



### Other Recommended Reading

Ellik, Ron and Evans, Bill. *The Universes of E. E. Smith; A concordance to the "Lensman" and "Skylark" novels*. An extremely useful index to the works of the First Historian.

Randall Garrett. "Backstage Lensman," *Takeoff!* A parody, based chiefly on *Gray Lensman*. Doc was very amused by it and contributed some details of his own.

Robert Heinlein. "Larger than Life," *Expanded Universe*. Praises Doc as a man while thoroughly defending the most-criticized facets of his writing.

—Various. Heinlein mentioned Lensmen *en passant* in a few of his works. In *Number of the Beast*, interdimensional travelers enter the universe of the Lens and are nearly arrested for drug-smuggling by a Lensman who later makes a cameo appearance in *The Cat Who Walks Through Walls*.

George O. Smith. *Venus Equilateral*. Nothing to do with Doc or the Civilization of the Lens, but very similar in tone. Vacuum-tube electronic engineers run a communications relay in one of Venus' Trojan points.

Joseph Sanders. *E.E. "Doc" Smith*. A short biography of the man and criticisms of his writing.

E.E. "Doc" Smith. *Norwescon* (speech). Doc answers his critics.

Verna Smith Trestrail. Keynote speech, *Moscon I*. Doc's daughter describes him and his family.

# I N D E X

- Absorption screens, 68.  
Academy, 12.  
Accommodations, 67.  
Accumulators, 67.  
Addiction disadvantage, 29.  
Advantages, 25-29.  
Adventure seeds, 121-125.  
Aiming bonus, 107; *sustained fire*, 108.  
Alcohol, 85.  
Aldebaran I, 56.  
Aldebaran II, 56.  
Allies advantage, 25.  
Allotropic iron converters, 67.  
Alternate Identity advantage, 27.  
Ambassador, 19.  
Amphetamine, 85.  
Appearance disadvantage, 30.  
Arisia, 56, 121.  
Arisians, 40.  
Armor, *personal*, 81.  
Armoury skill, 31.  
Artificial gravity, 75.  
Atomic Vortices, 54; *loose*, 54; *sources*, 54-55.  
Barbiturates, 85.  
Battle stations, 112.  
Beams, 71; *macro*, 113; *needle*, 113; *pressor*, 75; *primary*, 71.  
Bennett, 56.  
Bentlam, 86.  
Bergenhalm drive, 70; *planetary*, 72.  
Bibliography, 126.  
Boskone, 14, 29.  
Broadcasters, 85.  
Bureaucrat, 20.  
Callisto, 58.  
Campaigns, 4, 117-125; *balance*, 120; *GURPS Cyberpunk*, 123; *Espionage*, 122; *Fantasy*, 123; *Illuminati*, 122; *Special Ops*, 122; *time period*, 121; *viewpoint*, 120.  
Cateagles, 55.  
Cavenda, 57.  
Characters, 18-36; *points*, 19; *types*, 19-24.  
Chickladorians, 40.  
Chocolate, 85.  
Cinematic play, 118.  
Civilization, 14; *dissent*, 17; *history*, 6-10; *law enforcement*, 16; *patriotism*, 15; *religion*, 17; *sex roles*, 15; *sexual mores*, 16; *societies*, 14; *taxes*, 15.  
Clear ether, 53.  
Code of Honor disadvantage, 30.  
Coffee, 85.  
Color Blindness disadvantage, 29.  
Combat, 103-116; *advanced*, 110; *basic*, 108; *cutter*, 109; *fire phase*, 108; *maneuver phase*, 108; *ship of the line*, 109; *turn sequence*, 108.  
Communications, 73-75.  
Compartmentalized Mind advantage, 27.  
Compulsion skill, 96.  
Computer Operation and Programming skills, 31.  
Contacts advantage, 27.  
Cost of living, 35.  
CRX, 73.  
Cyclonite, 77.  
Damage, *ship*, 106.  
Damaging inertialess objects, 113.  
Decompression, 104, 105.  
DeLameters, 80.  
Delgon, 57.  
Delgonians, 40.  
Demolitions, 77.  
Dextroboping skill, 32.  
Dhilians, 41.  
Dimensions, 67.  
Diplomat, 19.  
Disadvantages, 29-31.  
Display tanks, 75.  
*Donganeur* maneuver, 115.  
Driving jets, 69.  
Drug dealers, 24.  
Drugs, 85-88; *illegal*, 86-88; *legal*, 85-86; *toxicity*, 85.  
Duodecaplylatomate, 77.  
Dureum, 82, 84.  
Economics, 35.  
Eddore, 57, 121.  
Eddorians, 41.  
Eich, 41.  
Electronics and Electronic Operation skills, 31.  
Electronics, 65.  
Electros, 73.  
Emmfozing skill, 32.  
Enemy disadvantage, 29.  
Engineer, 20.  
Entertainer, 20.  
Ether density, 54.  
Ethereic jammers, 74.  
Europa, 58.  
Exalted, 29.  
Extremely Hazardous Duty disadvantage, 30.  
Fayalin, 86.  
Femme fatales, 20.  
Ferral paste, 77.  
Flying Head Butt maneuver, 115.  
"Free" combat, 79.  
Free Sick disadvantage, 30.  
Furball, 110.  
Galactic Patrol, 11-12, 21, 30; *Academy*, 12; *oath*, 12; *officers*, 11.  
Galactic patrolmen, 21, 30.  
Galactic Union, 13, 121.  
Gang members, 21.  
Ganymede, 58.  
Generators, *super-atomic*, 68.  
Gravity technology, 75-76.  
Gray Lensman, 26.  
Gray seal, 30.  
Guerrilla, 22.  
Hadive, 87.  
Hand thruster, 81.  
Heavy weapon harness, 84.  
Heptadetonite, 77.  
Heroin, 87.  
History, 5-17.  
Home front, 14.  
Hull, 66.  
Hyper-rotation, 84.  
Hyper-spatial tube, 84.  
Hypnotism skill, 31.  
Illusion skill, 94.  
Indetectability suite, 74.  
Inert collisions, 78; *planets*, 78.  
Inertia technology, 75-76.  
Inertialess Agility skill, 32.  
Innumerate disadvantage, 30.  
Integrating Calculator Operation skill, 32.  
Intimidation skill, 32.  
Intuitive Mathematician advantage, 28.  
Inventing maneuvers, 111.  
Involuntary Duty disadvantage, 30.  
Io, 58.  
Jarnevon, 57.  
Jobs, 35.  
Journalist, 24.  
Jovian Adept Combat style, 116.  
Jovians, 42.  
Jupiter, 57.  
Kalonians, 42.  
Kamikaze attacks, 106.  
Kinnison, Kimball, 47.  
Kinnison, Clarrissa, 48.  
Klono, 13.  
Klovvia, 58.  
Ladolian, 87.  
Language skills, 31.  
Law enforcement officer, 22.  
Legal Enforcement Powers advantage, 25.  
Lens, 10, 91-102.  
Lensman advantage, 28.  
Lensman's load, 30.  
Lensmen, 22.  
Lewistons, 80.  
Life support, 67.  
Lonabar, 59.  
Lyrane II, 59.



- Lyrane IX, 59.  
 Lyrane VIII, 59.  
 Lyranians, 42.  
 Macro beams, 71.  
 Magical Aptitude advantage, 25.  
 Magnetic boots, 81.  
 Maneuver rating, 106.  
 Manic-Depressive disadvantage, 30.  
 Mars, 59.  
 Martial arts, 114-116; *maneuvers*, 114-115; *styles*, 115-116.  
 Martians, 43.  
 Mechanic skill, 31.  
 Medical technology, 83.  
 Mental Blast skill, 95.  
 Mental Prowess, 12.  
 Mental Stab skill, 95.  
 Mentor, 26.  
 Meteor-miners, 22.  
 Military Hand-to-Hand Combat style, 115.  
 Military Rank advantage, 25.  
 Mind Block skill, 33.  
 Mindwipe, *detecting*, 100; *temporary*, 100; *undetactable*, 99.  
 Missiles, 74.  
 Molecular disruptor, 80.  
 Motors, *super-atomic*, 68.  
 Muscle Reading skill, 33.  
 Nadreck, 49.  
 Needlers, 71.  
 Negaspheres, 78.  
 Nevia, 60.  
 Nevian ferrosopic ray, 70.  
 Nevian paralysis projector, 81.  
 Nevians, 43.  
 Nhalians, 41.  
 Nitrolabe, 88.  
 Non-Striker Blow maneuver, 114.  
 Nullifier-Scramblers, 74.  
 Oglons, 55.  
 Onlo, 60.  
 Onlonians, 43.  
 Palain VII, 60.  
 Palainians, 38.  
 Partisan, 22.  
 Patron advantage, 26.  
 Phillips regeneration, 83.  
 Piloting skill, 32.  
 Pirate, 23.  
 Ploor, 61.  
 Ploorans, 43.  
 Pluto, 61.  
 Political correctness, 4.  
 Posenians, 44.  
 Power cells, 82; *replacing*, 83.  
 Power plants, 67-68.  
 Precision gunnery, 107.  
 Pressor beams, 75.  
 Primary beams, 71.  
 Professional criminals, 22.  
 Pseudoinertia generators, 75.  
 Psionic devices, 84.  
 Psionics skill, 34.  
 Races, 37-51.  
 Racial profile system, 38.  
 Radicals, 23.  
 Rigel, 61.  
 Rigellians, 39.  
 Sample characters, 46-51.  
 Sample ships, 89-90.  
 Scientist, 23.  
 Screens, 68, 112.  
 Second-stage stability, 29.  
 Secret agents, 24.  
 Secret disadvantage, 31.  
 Semi-portable, 81.  
 Sense of Perception advantage, 28.  
 Sensor suites, 73.  
 Sensors, 73-75.  
 Shells, 74.  
 Ship classes, 105.  
 Ship construction, 66-76.  
 Ship upkeep, 69.  
 Skills, 31-34; *telepathic*, 93-97.  
 Social Status, 35.  
 Social Stigma disadvantage, 29.  
 Society, 5-17.  
 Solarian League, 14, 121.  
 Space armor, *dureum*, 82; *light*, 81; *marine*, 82; *Valerian*, 82.  
 Space Marine Hand-to-Hand Combat style, 116.  
 Space opera combat system, 104-111; *in Lensman*, 112-113.  
 Space-axes, 81.  
 Spacemen, 24.  
 Spybeams, 80.  
 Standish, 81.  
 Status, 35.  
 Streamlining, 66.  
 Striker Blow maneuver, 114.  
 Sub-etheric jammers, 74.  
 Suggest skill, 95.  
 Sunbeams, 79.  
 Tea, 85.  
 Tech stages, 65; *history*, 65; *power*, 66; *transportation and communication*, 65; *weapons and armor*, 66.  
 Technicians, 24.  
 Technology, 64-90.  
 Telepathic assistance, 102.  
 Telepathic eavesdropping, 101.  
 Telepathic fusions, 101.  
 Telepathy, 91-102; *improving*, 92; *advanced techniques*, 98-102; *aimed mental blows*, 98; *area attacks*, 93; *brute force attacks*, 99; *combination attacks*, 97; *deathscream*, 96; *enhancements*, 101; *extended range*, 102; *limitations*, 101; *ricochets*, 95; *subtle subversion*, 99; *in battle*, 98.  
 Telescan skill, 97.  
 Tellus, 61.  
 Temporary Identity advantage, 27.  
 Theme music, 124.  
 Thionite, 86, 87.  
 Thought-screens, 85.  
 Thrallis IX, 60.  
 Thuleschlag style, 116.  
 Tobacco, 86.  
 Tomingans, 42.  
 Tractor beams, 75.  
 Tractor lock, 112.  
 Tractor shears, 76.  
 Tractor zones, 76.  
 Tregonsee, 50.  
 Trengo, 61.  
 Triplanetary League, 13, 121.  
 Tsudo style, 116.  
 Ultra-wave communications suite, 73.  
 Ultra-wave tracers, 73.  
 Unfazeable advantage, 28.  
 Units, 67.  
 Unorthodox tactics, 109.  
 Unusual Background advantage, 29.  
 Valeria, 62.  
 Valerians, 45.  
 Vee-Two gas, 77.  
 Vegia, 63.  
 Vegians, 44.  
 Velan, 63.  
 Velantia II, 57.  
 Velantia III, 63.  
 Velantian Combat style, 116.  
 Velantians, 40.  
 Venerians, 45.  
 Venus, 63.  
 Villain-driven plotting, 119.  
 VXN gas, 77.  
 Wealth, 35.  
 Weapons, 70-72, 77-81; *chemical*, 77; *individual*, 80-81; *mass destruction*, 77.  
 Wide-open N-way, 100.  
 Wide-open two-way, 99.  
 Wing Baffling maneuver, 114.  
 Women, 8, 10.  
 Worsel, 51.  
 Writers, 24.  
 Zabriska, 63.  
 Zabriskan fontema, 63.  
 Zwilniks, 14, 24.

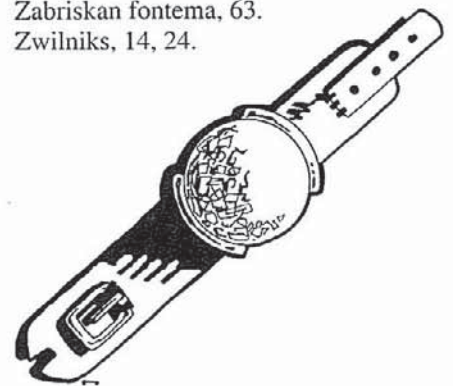

# GOOD AND EVIL



Before the creation of the myriad planets of the galaxies, two worlds and two races were already ancient — and already locked in a war of extinction. Even Arisia's supreme powers of the mind cannot restrain the Eddorian lust for dominance. Quarter or compromise is impossible. The only possible outcome is complete, utter annihilation.

The prize: the entire universe. The pawns on this final battleground: the young races of the galaxies — young races like humanity.

But pawns can be promoted. The Arisians have forged, eon by eon, a weapon of prodigious power, a hammer of war to smash Eddore and rid the universe of their transdimensional evil.

**The Lensmen of the Galactic Patrol.**

Eddore, too, has its playing pieces, arrayed in a network of drugs and crime that riddles the galaxies. Their conspiracy has infiltrated every world of Civilization with tentacles of corruption and decay. Their reach is universal, their power all but unstoppable, their ruthlessness and cruelty absolute. Many lives will be lost — Lensmen's lives. But Lensmen are responsible for the defense of Civilization itself. Lensmen always go in.

**Such is the Lensman's Load.**

**Welcome to the Universe of the Lens.**

**Welcome to total war.**

Written by Sean Barrett  
Edited by Scott Haring  
Cover by Kelly Freas  
Illustrated by Dan Smith  
Back Cover Art by Dan Smith  
and Derek Percy



**STEVE JACKSON GAMES**



ISBN 1-55634-283-7

**SJG01695 6067**

Made in the U.S.A.