



**JoyRide**  
BIKES®

## E-BIKE OWNER'S MANUAL

THIS MANUAL CONTAINS IMPORTANT SAFETY INFORMATION.  
PLEASE READ AND KEEP FOR FUTURE REFERENCE.



Motorized bicycles are new to most riders so in the interest of safe cycling make sure you read, understand, and follow the instructions in this manual.

This manual contains important safety, signal words such as **DANGER**, **WARNING**, **CAUTION**, **IMPORTANT**, and **NOTE** or **NOTICE**. These are important signal words telling you to pay special attention to that text as rider safety is involved.

**▲ This symbol will appear in areas of critical rider safety.**

**▲ DANGER** and **WARNING**: Pay special attention to these since failure to do so could result in serious injury or death to the rider or others.

**CAUTION**: If not followed these instructions could result in injury or mechanical failure or damage to the bicycle.

**NOTE** or **NOTICE** or **IMPORTANT**: These specify something that is of special interest. Read and pay close attention as your safety and that of your bicycle are involved.

**IMPORTANT**: Read the **BEFORE RIDING** section and check that all parts are installed and working as per this manual. If you understand how the bicycle operates, you will get the best performance. When you read this manual, compare the illustrations to the bicycle. Learn the location of all the controls and parts as well as how they work. **KEEP THIS BOOK FOR FUTURE REFERENCE.**

**CAUTION** Before you ride the bicycle, check the brakes and other parts of the bike. Make sure all parts are assembled correctly, securely tightened and working properly. Take your first ride in a large, open, level area away from traffic. If you have a problem, call customer service at (1646).

Check and read this decal on your bicycle before each ride:





## **WARNING!**

Different materials and components may react to wear or fatigue in different ways. If the design life of a component has been exceeded, it may suddenly fail possibly causing injuries to the rider. Any form of crack, scratch or change of coloring in highly stressed areas indicate that the life of the component has been reached and it should be replaced. Do not ride in an abusive manner,

In this manual, the **CAUTION** sign indicates a hazardous situation which, if not avoided, can cause minor or moderate injury.

In this manual, the **WARNING** sign indicates a hazardous situation which, if not avoided, can cause death or serious injury.

Great care should be taken when adjusting the bike hardware on. If you do not understand how to adjust the ebike hardware, please contact your local bike specialist.

## **DO NOT RIDE YOUR EBIKE WITHOUT ALL HARDWARE SECURELY FASTENED.**

Make sure you read this complete manual before riding your bike. Failure to do so, or failure to follow its guidelines could lead to serious injury or death.

Brake pads and rotors get very hot during use and could burn skin. The edges can also be very sharp and cut skin. Do not touch the brake pads or rotors directly after riding your ebike.

Proper use of your brake is vital to ensure safe, efficient stopping. To avoid misuse and potential injury, do not apply sudden or excessive force to your brakes. Apply your brakes gradually and give yourself enough room to come to a complete stop safely.

Different localities and countries have different laws governing riding on public roads, and you should check with local officials to ensure you are complying with these laws.

Brakes do not work as well under wet conditions as they do when dry. It is recommended that you do not ride your ebike in wet weather, as there are electronic components of your ebike that may be damaged if exposed to water.

Wet conditions will require a longer distance to stop. Brake earlier and avoid sudden stops when riding in wet conditions.

When you ride in low-visibility conditions such as fog, dusk, or night, you might be difficult to see, which could lead to a collision. Wear bright reflective clothing when riding in poor lighting conditions.



## **WARNING**

There may be additional risk to injury if you use your ebike incorrectly. This includes, but is not limited to:

- Riding ebike over debris or obstacles
- Performing stunts
- Riding in off-road terrain
- Riding fast
- Racing other riders
- Riding in unusual manner

The aforementioned examples add stress to each part of your ebike and can lead to long term damage of the ebike. Damage to your ebike can lead to an accident or increase your risk of injury. To decrease your risk of injury, operate your ebike correctly.

## **IMPORTANT**

Do not ride the ebike without the battery pack. The battery pack must be on the ebike while riding or else the ebike's motor and safety lights will not function when needed.

Check to see that your wheels are securely fastened and that your helmet is securely fastened.

Protect the battery docking connector. When the battery pack is removed, apply a protective cover to prevent corrosion and damage to the connector.

Remove the battery pack from the ebike and store it elsewhere in the vehicle during your transport.

Always respect local laws about transportation of an electric bicycle.

Lithium battery packs of this size and power are considered 'Dangerous goods, class 9, when transporting, regulations may restrict the transport of separate lithium batteries in some places,

## **WARNING!**

Tampering or modifying the electric circuit system may cause a shock, fire or explosion and permanently damage the system. Exposed wiring and circuitry in the charger may cause electric shock. Always keep the charger housing closed.

Non-rechargeable batteries are not to be recharged.



### **WARNING!**

**SEEK IMMEDIATE MEDICAL ATTENTION IF YOU ARE EXPOSED TO ANY SUBSTANCE THAT IS EMITTED FROM THE BATTERY PACK.**

For all equipment, the instructions shall indicate "This equipment is not intended to be used at ambient temperatures less than -20°C (-4°F) or above ambient temperatures of 55°C (131°F)."

The blanks are to be filled in with the manufacturer's specified ambient temperature ratings.

For all equipment, the instructions shall indicate "The battery is intended to be charged when the ambient temperature is between 0°C (32°F) and 40°C (104°F)."

### **SAFETY PRECAUTIONS**

- If the ebike is not to be used for an extended period of time, you may need to recharge the battery every 1 month to maintain the battery life.
- Ensure that the screws on the front and back tires are locked firmly before each ride..
- Check to ensure the tires are not worn..
- Check to ensure all connections are maintained on your ebike.
- Ensure the brake cables are well lubricated. It is suggested you lubricate brakes every 6 months
- Ensure all gears move smoothly.
- Make sure there are no frayed cables, loose connections, missing fasteners or axle/lug nuts.
- For your safety, always wear a helmet that meets CPSC or CE safety standards, In the event of an accident, a helmet can protect you from serious injury and in some cases, even death..
- Obey all local traffic laws, Obey red and green lights, one-way streets, stop signs, pedestrian crosswalks, etc..
- Ride with the traffic, not against it.
- A crash can put extraordinary stress on your ebike's components, possibly causing them to fatigue prematurely. Components suffering from stress fatigue can fail suddenly, causing loss of control, or serious injury.

### **CARE & MAINTENANCE**

- Do not expose the ebike to liquid, moisture, or humidity to avoid damage to the electrical system.
- Do not use abrasive cleaning solvents to clean the ebike.
- Do not expose the ebike to extremely high or low temperatures as this will shorten the life of the electrical system, destroy the battery, and/or distort certain plastic parts..
- Do not dispose of the ebike in a fire as it may explode or combust..
- Do not expose the ebike to contact with sharp objects as this will cause scratches and damage.
- Do not let the ebike fall from high places, as doing so may damage the internal circuitry.
- Do not attempt to disassemble the ebike.
- Use only the specified charger provided.
- Ensure the ebike chain is well lubricated for optimal performance.
- To minimize tire wear and for maximum riding safety, comfort and handling, maintain recommended tire air pressure which can be found on the side wall of all tires. Use a reliable tire air pressure gauge to check for proper inflation before every ride. At the same time, inspect tires for excessive wear and cracks. Replace tires if necessary.

# CONTENTS

PREFACE.....	2-4
PARTS IDENTIFICATION CHART .....	5-6
BEFORE RIDING.....	7-12
ASSEMBLING YOUR BIKE .....	13-28
OPERATING PROCEDURES.....	29-32
MONITOR DISPLAY .....	33
MAINTENANCE/REPAIR .....	34-48
TROUBLESHOOTING .....	49-52
ELECTRIC BIKE FAQs.....	53-54
LIMITED WARRANTY .....	55-56
IMPORTANT INFORMATION .....	57

# PREFACE

**Congratulations on the purchase of your new bike! With proper assembly and maintenance it will offer you years of enjoyable riding!**

**IMPORTANT:** Carefully read and follow this manual (and any other materials included with this bike) before riding. Please retain this manual for future use. If this bike was purchased for a child, it is the responsibility of the purchaser to verify the bike has been properly assembled, and that the user has been properly trained and instructed in use of the bike.

This manual is provided to assist you and is not intended to be a comprehensive manual covering all aspects of maintaining and repairing your bicycle. The bicycle you have purchased is a complex piece of equipment that must be properly assembled and maintained in order to be ridden safely. **If you have any doubts about the assembly or your ability to properly assemble and maintain the bicycle. You must have it assembled and maintained by a professional bicycle mechanic.**

**WARNING:** Electric bikes are fun to ride but can be dangerous to use. The user or consumer assumes all risk of personal injuries, damage, or failure of the bicycle or system and all other losses or damages to themselves and others and to any property arising as a result of using the bicycle.



**DO NOT DISASSEMBLE, MODIFY OR REPLACE ELECTRICAL PARTS.**

**If you need to change any parts, please consult a professional bicycle mechanic or contact customer service for additional help.**



**NOTE:** YOUR INSURANCE POLICIES MAY NOT PROVIDE COVERAGE FOR ACCIDENTS INVOLVING THE USE OF THIS BICYCLE. TO DETERMINE IF COVERAGE IS PROVIDED YOU SHOULD CONTACT YOUR INSURANCE COMPANY OR AGENT.

**DANGER!** Failure to properly assemble and maintain your bicycle could result in serious injury or death to the rider.

**This manual contains important safety, performance and service information.** The purpose of this Owner's Manual is to help you use your bike safely in the manner it is intended and allow you to enjoy the benefits it offers for many years to come. **Please read it before you take the first ride on your new bicycle, and keep it for reference.**

If you have any questions or do not understand something, take responsibility for your safety and contact Joy Ride Bike customer service at **1-800-493-1646**.



**ALWAYS WEAR A PROPERLY FITTED HELMET WHEN YOU RIDE YOUR BICYCLE. DO NOT RIDE AT NIGHT. AVOID RIDING IN WET CONDITIONS.**

# PREFACE

## RESPONSIBILITY OF THE OWNER!

**IMPORTANT:** Reading and following the information and instructions in this manual are essential to the ability of the owner or any other persons allowed to use this bicycle in order to ride safely.

1. It is the responsibility of the owner or in the case of a younger rider the parents of the rider to be certain all assembly instructions have been followed, even if the bike has been assembled by the seller or a professional assembly company.
2. Brakes are essential to safety. Be sure they are checked and working properly before each use. Remember that any mechanical system changes condition during use and must be maintained and checked before each use.
3. Rules for bicycle use (bicycle laws) vary from location to location so be certain the rider knows and understands the rules that apply to bicycle usage in all areas where the bicycle will be used. Wearing a helmet, light or reflective clothing, using lights and reflectors are examples of rules which may exist and which make sense as rider safety precautions at all times.
4. Know how to operate the bicycle and all equipment on it before first use and be certain anyone allowed to use the bike knows how to properly and safely use the bike as well.
5. There are many different types of bicycles and often these types are designed for different uses. Make sure you know what type unit you have and do not exceed its service limitations. Be sure you check and understand the bicycle classifications set in this manual, including size of the unit that is proper for the rider to insure good control during use. Riders who are too small or large may have control problems. Do not overload a unit with a rider that is too heavy or too large, and do not attempt to carry extra passengers, packages or loads on the bicycle. Do not use street bikes for off road riding.
6. Your electric bike is water-resistant, but must be properly maintained to preserve this condition. Please do not submerge the bicycle or any electric components in water. Water entering electric components can cause a short circuit and damage the electric components with possible injury to the rider and others.
7. The battery's performance can be effected by its environment. Generally speaking, battery's discharge performance is better in a higher temperature. Electric power will drop by more than 1/3 when the temperature is below 32°F (0°C). Thus, this e-bike's riding distance per charge will become shorter in winter or cold areas. It returns to normal / optimal when the temperature is higher than 68°F (20°C).
8. Do not put any metal objects in charge hole or battery circuit, it may cause a short circuit, start a fire, or cause an explosion with personal injury or property damage.

**NOTE: Max weight of rider+luggage+bike = 220lbs/100kg~265lbs/120kg**



# PREFACE

**CAUTION:** For your safety you must carefully read this manual and follow its instructions. Your bicycle may come with additional instruction sheets that cover features unique to your bike. Please ensure that you read and become familiar with their contents and retain them with this manual for future reference. Remember bicycles, in most areas, are subject to the same laws, rules, and regulations as motor vehicles.

**Always wear a CPSC approved helmet when riding your bike.**

**Learn and follow local and state traffic use laws.**

Any major service or adjustments on your bike not covered in this manual should be carried out by a professional bicycle mechanic. If you wish to make adjustments yourself, this manual contains important tips on how to do it.

**CAUTION:** Any adjustments you make are entirely at your own risk. Do **NOT** use your bike for freestyle and stunt riding, jumping or competitive events. Even if you are riding a mountain bike, you should know that off-road use or any similar activities can be dangerous, and you assume the risk for personal injury, damages or losses incurred from such use. Do not ride your bike when any part is damaged or not working properly. **You must, for your safety and the safety of other users, consult a professional bicycle mechanic for any questions on repairs or maintenance.**

**WARNING:** As with all mechanical components, the bicycle is subjected to wear and high stresses. Different materials and components react to wear or stress fatigue in different ways. As your bicycle ages, you should inspect it more frequently to look for deformed, cracked, bent, or loose components. Such conditions may lead to sudden failure. This may possibly cause injuries to the rider. If something is cracked or broken, do not ride until repairs have been made.

**NOTE: BEFORE TRANSPORTING THE BIKE AND/OR BATTERY, CALL CUSTOMER SERVICE AT 1-800-493-1646 FOR SPECIFIC DETAILED INSTRUCTIONS.**



## ALWAYS WEAR A HELMET-IT COULD SAVE YOUR LIFE!

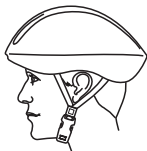

**CORRECT**

Forehead Covered

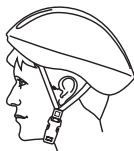

**INCORRECT**

Forehead Exposed

A properly fitting, CPSC approved, bicycle helmet should be worn at all times when riding your bicycle.

The correct helmet should:

- be lightweight and comfortable
- have good ventilation
- cover the forehead and fit correctly
- be securely fastened on the rider

# PARTS IDENTIFICATION

1. Tire
2. Motor
3. V-Brake
4. Saddle
5. Frame
6. Monitor Display
7. Handlebar Stem
8. Handlebar
9. Headlight
10. Battery
11. Chain
12. Chainwheel
13. Kickstand
14. Crank&Pedal
15. Fork

## CIRCUIT DIAGRAM

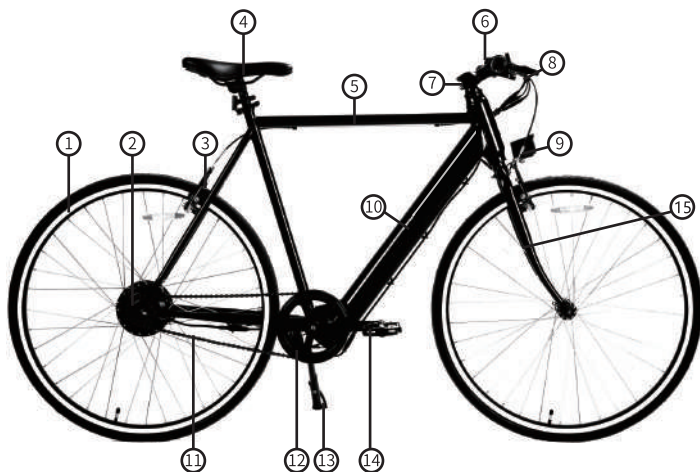
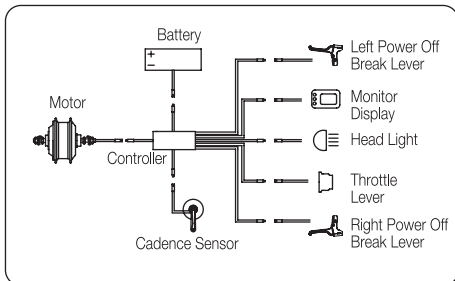

# PARTS IDENTIFICATION

1. Tire
2. Motor
3. V-Brake
4. Saddle
5. Frame
6. Monitor Display
7. Handlebar Stem
8. Handlebar
9. Headlight
10. Battery
11. Chain
12. Chainwheel
13. Crank&Pedal
14. Fork
15. Kickstand

## CIRCUIT DIAGRAM

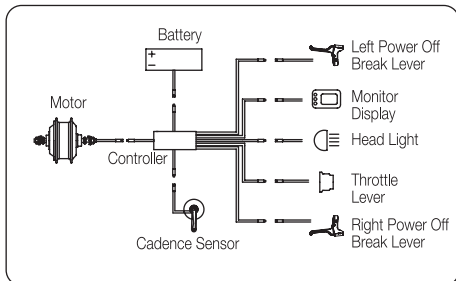

# PARTS IDENTIFICATION

1. Tire
2. Motor
3. V-Brake
4. Saddle
5. Frame
6. Monitor Display
7. Handlebar Stem
8. Handlebar
9. Headlight
10. Battery
11. Kickstand
12. Chain
13. Chain Cover
14. Chainwheel
15. Crank&Pedal
16. Fork

## CIRCUIT DIAGRAM

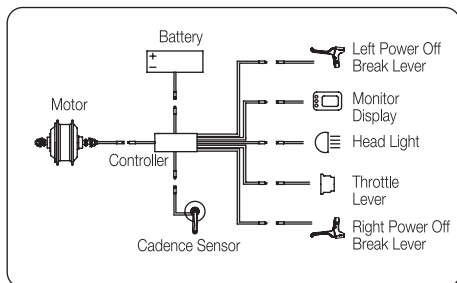

# PARTS IDENTIFICATION

1. Tire
2. Tail light
3. Motor
4. Disc-Brake
5. Saddle
6. Frame
7. Monitor Display
8. Handlebar Stem
9. Handlebar
10. Headlight
11. Battery
12. Derailleur
13. Chain
14. Kickstand
15. Chainwheel
16. Crank&Pedal
17. Disc
18. Fork

## CIRCUIT DIAGRAM

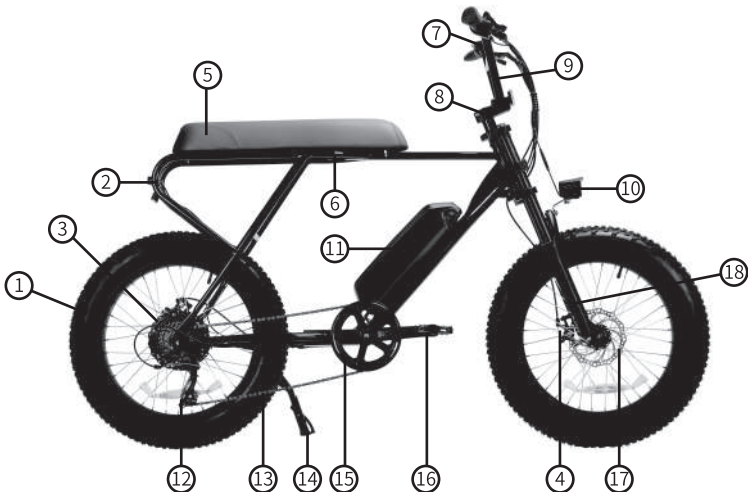
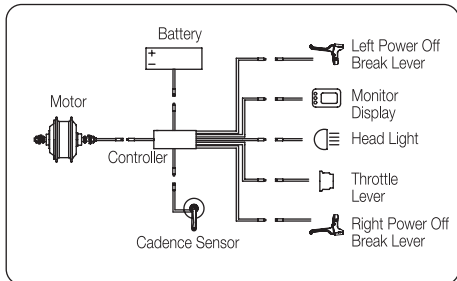

# PARTS IDENTIFICATION

1. Tire
2. Motor
3. Disc-Brake
4. Saddle
5. Frame
6. Monitor Display
7. Handlebar Stem
8. Handlebar
9. Headlight
10. Battery
11. Derailleur
12. Chain
13. Kickstand
14. Chainwheel
15. Crank&Pedal
16. Fork
17. Disc

## CIRCUIT DIAGRAM

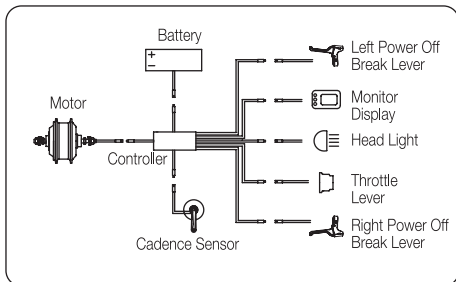

# PARTS IDENTIFICATION

1. Tire
2. Motor
3. V-Brake
4. Saddle
5. Frame
6. Monitor Display
7. Handlebar Stem
8. Handlebar
9. Headlight
10. Battery
11. Chain
12. Chainwheel
13. Kickstand
14. Crank&Pedal
15. Fork

## CIRCUIT DIAGRAM

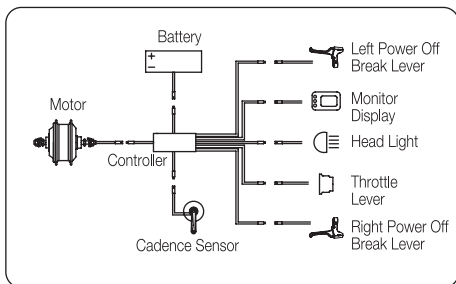

# PARTS IDENTIFICATION

1. Monitor Display (Left Side)
2. Handlebar
3. Throttele (Right Side)
4. Handlebar Stem
5. Headset
6. Front Light
7. Fork
8. Front Brake
9. Pedal
10. Crankset
11. Cadence Sensor
12. Chain
13. Rear Derailleur
14. Motor
15. RIM
16. Tire
17. Rear Brake
18. Rear Carrier
19. Fender
20. Saddle
21. Battery
22. Charging Port
23. Frame
24. Controller (Inside Battery Holder)

## CIRCUIT DIAGRAM

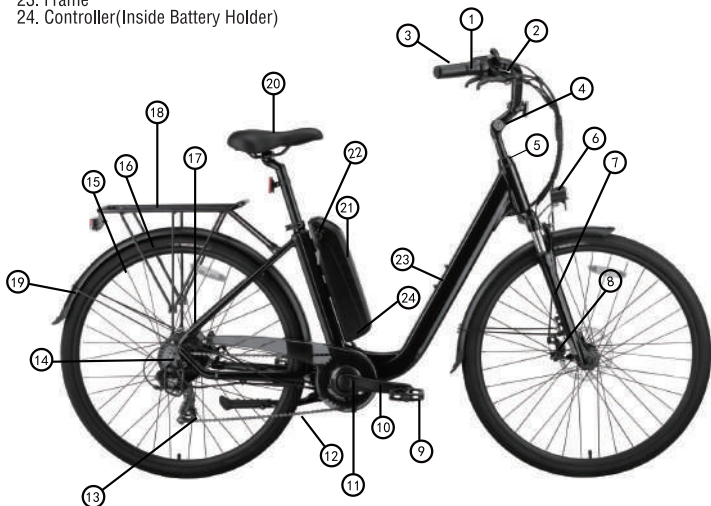
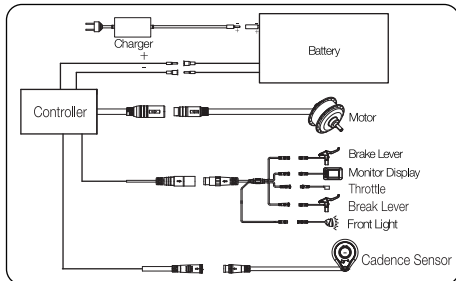



# PARTS IDENTIFICATION

1. Monitor Display (Left Side)
2. Handlebar
3. Throttele (Right Side)
4. Handlebar Stem
5. Headset
6. Front Light
7. Fork
8. Front Brake
9. Pedal
10. Crankset
11. Cadence Sensor
12. Chain
13. Rear Derailleur
14. Motor
15. RIM
16. Tire
17. Rear Brake
18. Saddle
19. Battery
20. Charging Port
21. Frame
22. Controller(Inside Battery Holder)
23. Rear Sho

## CIRCUIT DIAGRAM

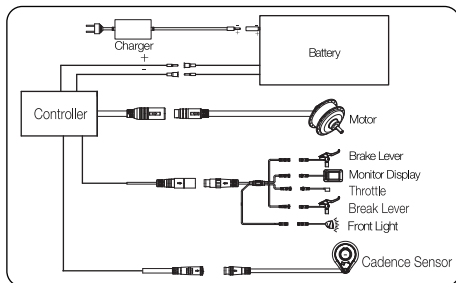

# PARTS IDENTIFICATION

1. Monitor Display (Left Side)
2. Handlebar
3. Throttle
4. Handlebar Stem
5. Headset
6. Fork
7. Front V-Brake
8. Front Light
9. Battery
10. Charging Port
11. Controller (Inside Battery Holder)
12. Crankset
13. Pedal
14. Cadence Sensor
15. Chain
16. RIM
17. Tire
18. Rear Brake
19. Saddle
20. Frame
21. Rear V-brake
22. Chaincover

## CIRCUIT DIAGRAM

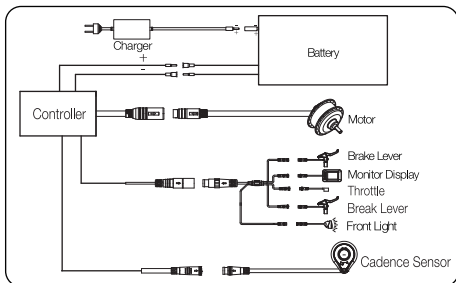

# PARTS IDENTIFICATION

1. Monitor Display(Left Side)
2. Handlebar
3. Throttele (Right Side)
4. Handlebar Stem
5. Headset
6. Front Light
7. Fork
8. Front Brake
9. Pedal
10. Crankset
11. Cadence Sensor
12. Chain
13. Rear Derailleur
14. Motor
15. RIM
16. Tire
17. Rear Brake
18. Saddle
19. Battery
20. Charging Port
21. Frame
22. Controller(Inside Battery Holder)

## CIRCUIT DIAGRAM

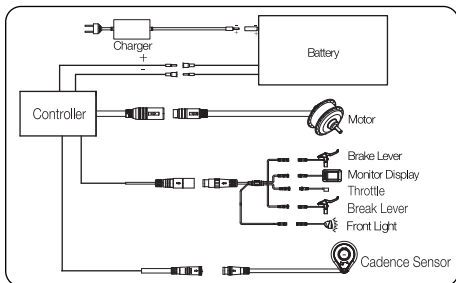

# PARTS IDENTIFICATION

1. Monitor Display(Left Side)
2. Handlebar
3. Throttele (Right Side)
4. Handlebar Stem
5. Headset
6. Front Light
7. Fork
8. Front Brake
9. Pedal
10. Crankset
11. Cadence Sensor
12. Chain
13. Rear Derailleur
14. Motor
15. RIM
16. Tire
17. Rear Brake
18. Saddle
19. Battery
20. Charging Port
21. Frame
22. Controller(Inside Battery Holder)

## CIRCUIT DIAGRAM

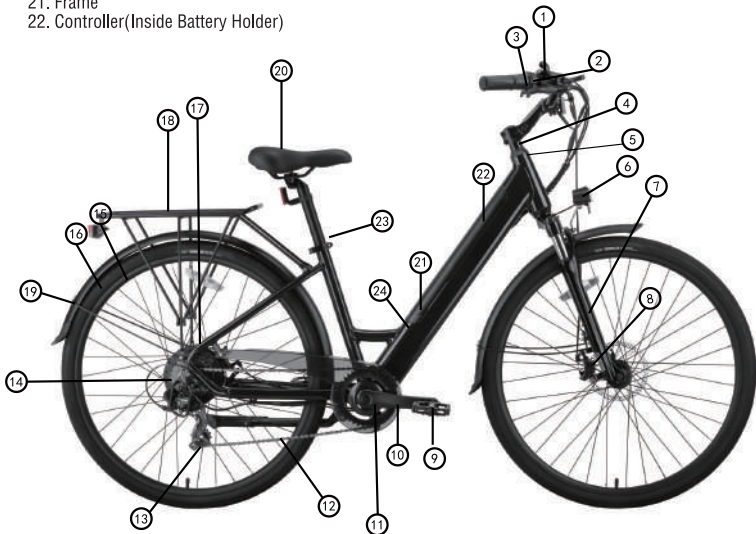
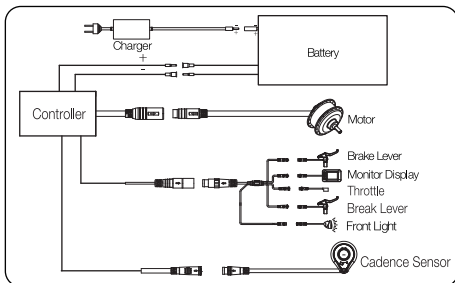

# PARTS IDENTIFICATION

1. Monitor Display (Left Side)
2. Handlebar
3. Throttle
4. Handlebar Stem
5. Headset
6. Fork
7. Front V-Brake
8. Battery
9. Charging Port
10. Controller (Inside Battery Holder)
11. Crankset
12. Pedal
13. Cadence Sensor
14. Chain
15. RIM
16. Tire
17. Rear Brake
18. Saddle
19. Frame
20. Rear V-brake
21. Chaincover
22. Front Light

## CIRCUIT DIAGRAM

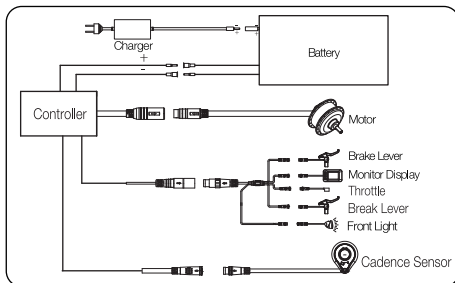

# PARTS IDENTIFICATION

1. Monitor Display (Left Side)
2. Handlebar
3. Throttle
4. Handlebar Stem
5. Headset
6. Fork
7. Front V-Brake
8. Battery
9. Charging Port
10. Controller (Inside Battery Holder)
11. Crankset
12. Pedal
13. Cadence Sensor
14. Chain
15. RIM
16. Tire
17. Rear Brake
18. Saddle
19. Frame
20. Rear V-brake
21. Fender
22. Front Light

## CIRCUIT DIAGRAM

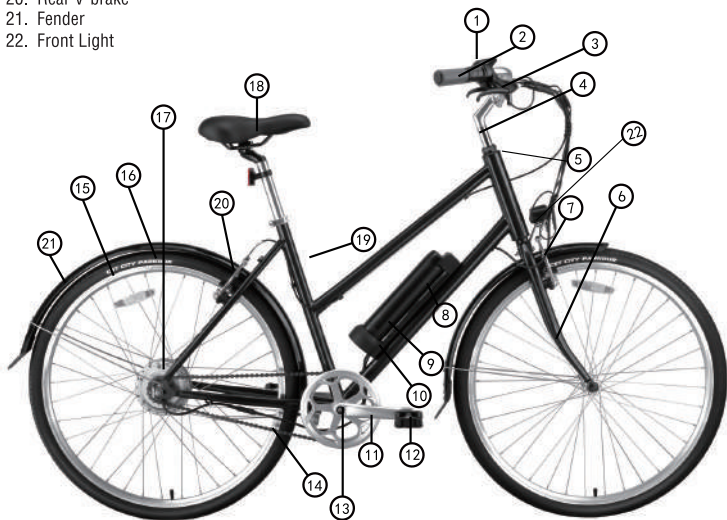
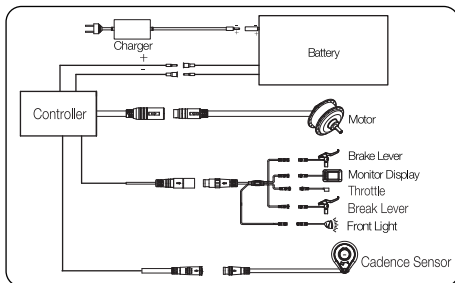

# BEFORE RIDING

**1. ⚠️ WARNING - ON AND OFF ROAD CONDITIONS:** The condition of the riding surface is very important to your safety. If the surface is wet, or has sand, leaves, small rocks or other loose debris on the surface where you plan to ride, carefully decrease the speed of the bicycle and ride with extra caution. It will take a longer time and more distance to stop. Apply the brakes sooner and with less force. Always apply the rear brake first allowing time and distance for it to take effect. Then follow by cautiously applying the front brake, in order to maintain control of the bicycle. Rapid front brake application first may cause a front pitch over or fall. Learn to use your brakes properly under controlled conditions until you learn proper braking under all road conditions.

**2. NOTICE:** State and federal regulations require a full set of reflectors. Some state and local laws may require that your bike be equipped with a warning device, such as a horn or bell and most states require a light. The manufacturer and many legal authorities **DO NOT** approve or encourage riding at night. Vision is quite limited at dawn, dusk and at night for bike riders, motorists and by-standers. If you must ride at night, take extra precautions, use front and rear lights, wear flashers on your arms, wear light-colored clothing, and plan your route to ride in well lighted areas avoiding heavy traffic areas.

**3. NOTE:** Always wear shoes when riding a bicycle and avoid loose fitting clothes. Wear a cuff band or trouser clip to keep pants or other loose clothing from getting caught in the chain wheel. Long sleeves, long pants, gloves, eye protection, a CPSC approved helmet, elbow and knee pads are recommended.

**⚠️ Helmet use is required by law in many states and is always a good idea for your safety.**

**4. CAUTION: WET WEATHER WARNING:** Check your brakes frequently. The ability to stop is critical to your safety. Roads are slippery in wet weather so avoid sharp turns and allow more distance for stopping. Brakes become less efficient when wet. Leaves, loose gravel and other debris on the road can also lengthen stopping distance. If at all possible, do not ride in wet weather. Vision and control are impaired, creating a greater risk of accidents and injury.

**5. CAUTION:** A bicycle rider's best defense against accidents is to be alert to road conditions and traffic in the area. Do not wear anything that restricts your vision or your hearing.

**6. When riding, ALWAYS WEAR A CPSC APPROVED BIKE HELMET.** It may save your life.

**7. Obey all traffic regulations.** Most traffic regulations apply to bike riders as well as automobile operators. Observe all state and local traffic regulations, signs and signals. Check with your local police station on bicycle licensing and inspection, and where it is legal to ride your bike.

# BEFORE RIDING

**8.** Keep to the **RIGHT SIDE** of the road. Follow the traffic flow in a straight line close to the curb. Watch out for opening car doors and cars moving in and out of traffic. Use caution at intersections.

**9.** Never carry passengers. This is dangerous and it makes the bicycle harder to control. Never carry anything that can inhibit your ability to control the bicycle or see the road.

**10.** When riding in pairs or in larger groups, form a single line along the right side of the road. Set up a sensible distance between riders. Don't follow too closely.

**11.** Always be alert. Animals or people may dart in front of you. Give pedestrians the right-of-way. Don't ride too close to pedestrians, and don't park your bicycle where it can get in the way of foot/vehicle traffic.

**12.** Be careful at all intersections. Slow down and look both ways before crossing.

**13.** Use hand signals. Always let other drivers and pedestrians know what you are going to do. Signal 100 ft. before turning unless your hand is needed to control the bike.

**14. WARNING: NIGHT TIME OPERATION:** We do **NOT** recommend riding your bike at night. If you have an emergency that requires you to ride at night you must have proper lights and reflectors. **NEVER** ride at night without a helmet, taillight, a white front reflector, a red rear reflector, pedal reflectors and white wheel reflectors. You must be able to clearly see the surface where you are riding and be seen by others.

**15.** Never hitch rides. Never hold onto moving vehicles while riding. Never stunt ride or jump on your bike.

**16. ON AND OFF ROAD OPERATION:** Avoid the following road hazards: drain grates, pot holes, ruts, soft road edges, gravel, leaves (especially when they are wet), uneven pavement, railroad crossings, manhole covers, curbs, speed bumps, puddles, and debris as all have an effect on your riding and may result in loss of control. Adjust your speed and the way you use your brakes if you must ride in such areas.

**17.** If any components becomes loose while riding, (**STOP!!**) immediately and tighten, or bring to a mechanic for repair.



# BEFORE RIDING

Your new bicycle was assembled and tuned in the factory and then partially disassembled for shipping. The following instructions will enable you to prepare your bicycle for years of enjoyable cycling. For more details on inspection, lubrication, maintenance and adjustment of any area please refer to the relevant sections in this manual. **If you have questions about your ability to properly assemble this bicycle, please consult a professional bicycle mechanic before riding.**



**TO AVOID INJURY, THIS PRODUCT MUST BE PROPERLY ASSEMBLED BEFORE USE. WE STRONGLY RECOMMEND THAT YOU REVIEW THE COMPLETE ASSEMBLY GUIDE AND PERFORM CHECKS SPECIFIED IN THE OWNER'S MANUAL BEFORE RIDING.**

## Tools required for assembly:

- 5/6mm hex wrench
- Torque wrench
- Air pump & tire gauge to inflate tires
- Bicycle lubricant or grease
- 6" adjustable wrench
- Phillips & standard screwdrivers
- Pliers with cable cutting ability

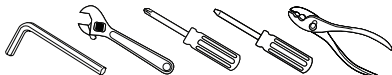

## RECORD SERIAL NUMBER

Each bicycle has a serial number stamped into the bottom of the down tube (See Illustration).

Record this number HERE to keep for future reference.

This number can be helpful to reclaim your bike if ever lost or stolen. **THIS INFORMATION IS ONLY AVAILABLE ON THE BIKE ITSELF.** There is no record of your serial number at the store purchased or with our company. It is your responsibility to record this information.

Serial Number Location

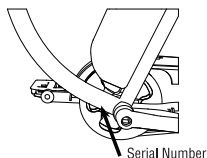

Serial Number: \_\_\_\_\_

# BEFORE RIDING

Just a minute spent before each ride can significantly improve your safety and the enjoyment of your ride. So, **EACH TIME** before you ride make a habit of performing the following safety checks:

- Stand in front of the bicycle facing rearward and hold the front wheel securely between your legs. Try to twist the handlebar and verify that they do not move. Then pull the handlebars up, trying to lift the bike. There should be no movement.
- Try to push the front wheel from side to side and confirm that it feels tight and will not wobble. Lift the front wheel up by the handlebars and strike the wheel downward with the heel of your hand to confirm that it is securely attached to the wheel. Spin the front wheel and confirm that it does not wobble or contact the fork or brake pads.
- Try to lift/push down on and twist the seat to confirm it is tight.
- Look at the connection of the pedals to the crank arm. You should not see pedal screw threads and the pedal should feel firm and be parallel to the ground.
- Apply your brake(s) and make sure they feel firm to the touch, and then spin the wheel(s). Apply the brakes. The brakes should stop the wheel(s).
- Check to be sure that the fenders and accessories (if equipped) are firmly attached and will not contact any moving parts. Make sure all reflectors are in position and not broken.

Now, put on your **BICYCLE SAFETY HELMET** and enjoy your ride. Your safety is well worth **just a minute**. Also, be sure to read and follow the warnings and instructions in this manual.

# BEFORE RIDING

## CORRECT FRAME SIZING:

When selecting a new bicycle, the correct choice of frame size is a very important safety consideration. The ideal clearance will vary between types of bicycles and rider preference. This makes straddling the frame when off the saddle easier and safer in situations such as sudden traffic stops. Women can use a man's bicycle to determine the correct size women's model.

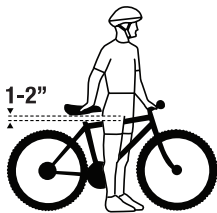

**⚠** THERE SHOULD BE A CLEARANCE OF NO LESS THAN 1-2 INCHES BETWEEN THE GROIN AREA OF THE INTENDED RIDER AND THE TOP TUBE OF THE BICYCLE, WHILE THE RIDER STRADDLES THE BICYCLE WITH BOTH FEET FLAT ON THE GROUND.

**⚠** THE SEAT POST "MINIMUM INSERTION" / "MAXIMUM HEIGHT" MARK SHOULD NOT BE VISIBLE WHEN THE SEAT POST IS INSERTED INTO THE SEAT MAST OF THE BIKE. DO NOT RAISE THE SEAT POST BEYOND THIS MARK, THE SEAT POST OR FRAME MAY BREAK CAUSING YOU TO LOSE CONTROL AND FALL. ALWAYS CHECK TO MAKE SURE THE SEAT POST ADJUSTING MECHANISM IS TIGHTENED SECURELY BEFORE RIDING.

# BEFORE RIDING

## RIDING POSITION:

### SADDLE HEIGHT

In order to obtain the most comfortable riding position and offer the best possible pedaling, correct saddle height should not allow leg strain from over-extension, and the hips should not rock from side to side when pedaling. While sitting on the bicycle with one pedal at its lowest point, place the ball of your foot on the pedal. The correct saddle height will allow the knee to be slightly bent in this position.

### REACH

To obtain maximum comfort, the rider should not over extend his or her reach when riding. There should be a slight bend in the rider's elbows. Refer to the section regarding seat and seat posts to learn how to adjust the seat post height.

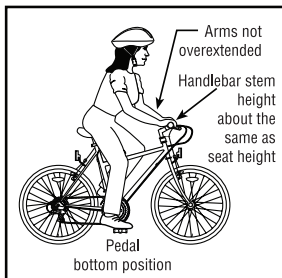

# ASSEMBLING YOUR BIKE

## PREPARATION

It is important that you read this owner's manual before you start to assemble your bicycle. **WE RECOMMEND THAT YOU CONSULT A PROFESSIONAL BICYCLE MECHANIC IF YOU HAVE DOUBTS OR CONCERNS AS TO YOUR ABILITY TO PROPERLY ASSEMBLE, REPAIR, OR MAINTAIN YOUR BICYCLE.** Remove all parts from the shipping carton. Check to make sure no parts are loose on the bottom of the carton. Carefully remove the front wheel which is attached to the side of the bicycle for shipping. Carefully remove all other packing material from the bicycle. This includes zip ties, axle caps and material protecting the frame.

## FRONT WHEEL

1. Remove the nuts, washers and wheel retainers from the front wheel.
2. Slide the wheel onto the open ends of the fork. Slip an axle retainer onto each end of the axle, and hook the retainers into the holes in the fork end. Loosely install the washer onto each end of the axle (serrated end toward the retainer), then install the hex nut. (Note: there may be a washer head nut in place of the washer and hex nut).
3. Center the wheel in the fork and tighten the axle nuts securely, alternating from one side to the other to center the wheel.
4. Spin the wheel to make sure that it is centered in the fork and does not wobble. If the wheel is not centered, loosen the nuts and try again.
5. If your bicycle has a quick release mechanism, read and follow the quick release information on this manual.

Torque requirement: 16-20 ft. lbs.

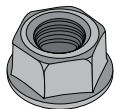
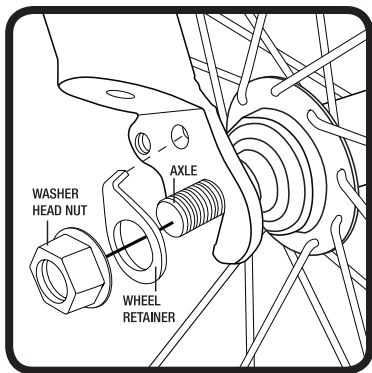

# ASSEMBLING YOUR BIKE

## QUICK RELEASE FRONT WHEEL

Some bicycles have wheel axles that incorporate a Quick Release (QR) mechanism. This allows easy wheel removal without the need for tools. The mechanism uses a long bolt (called a skewer) with an Adjusting Nut on one end, and a lever operating a cam-action tensioner on the other. With the quick release lever in the open position, insert the front wheel into the open ends of the fork. Turn the adjusting nut so that the locking lever is moved to the closed position with a firm action. At the halfway closed position of the quick release lever, you should start to feel some resistance to this motion. Do not tighten the quick release by using the quick release lever like a wing nut. If the quick release lever is moved to the closed position with little or no resistance, clamping strength is insufficient. Move the quick release lever to the open position, tighten the quick release adjusting nut, and return the quick release lever to the closed position.

### CORRECT QUICK RELEASE AXLE SETTING:

1. To set, turn the lever to the open position so that the curved part faces away from the bicycle.
2. While holding the lever in one hand, tighten the Adjusting Nut until it stops.
3. Pivot the lever toward the closed position. When the lever is halfway closed, there must be firm resistance to turn it beyond that point. If resistance is not firm, open the lever and tighten the Adjusting Nut in a clockwise direction.

**⚠ WARNING! IF YOU ARE USING A UNIT EQUIPPED WITH A QUICK RELEASE, ALWAYS MAKE SURE THE QUICK RELEASE LEVER IS SECURELY CLOSED IN A LOCKED POSITION. ALSO BE CERTAIN YOUR QUICK RELEASE LEVER IS ON THE SIDE OPPOSITE TO THE DISC BRAKE IN YOUR UNIT.**

4. Continue to move the lever all the way to the closed position so that the curved part of the lever faces the bicycle.

5. The Quick Release is open when you are able to read **OPEN**. Verify the Quick Release is closed when you are able to read **CLOSED**.

6. Repeat process until quick release lever is securely closed in a locked position.

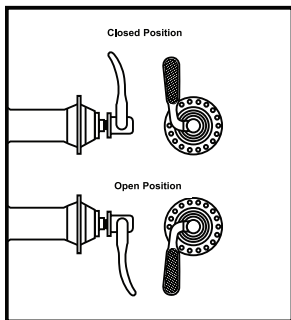
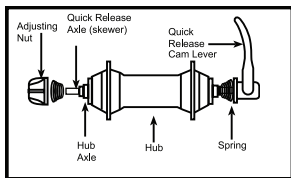

# ASSEMBLING YOUR BIKE

## KICKSTAND

If your bike is equipped with a kickstand, please follow the instructions below.

1. Place the bicycle in an upright position.
2. Remove the top plate from the kickstand.
3. From the left side of the bicycle (opposite side from chainring), place the kickstand in position beneath the two rear fork legs.
4. Place the top plate, flange down, onto the mounting bolt.
5. Replace the washer and nut onto the mounting bolt. Hold the kickstand arm in an up position aligned with the frame stay, then securely tighten the mounting bolt.
6. Leave the leg of the kickstand down so it will support the bicycle during the rest of the assembly process.

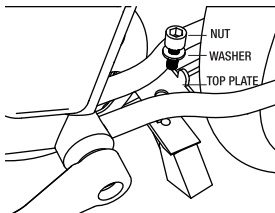

**⚠ WARNING! THE KICKSTAND IS DESIGNED TO SUPPORT THE BICYCLE ONLY, NOT THE BICYCLE AND RIDER.**

**⚠ WARNING! Use your kickstand to support the bike when not riding. Allowing your bike to lay on it's side can damage the brake levers and cause an unsafe riding condition and could result in injury to the rider.**

# ASSEMBLING YOUR BIKE

## PEDAL INSTALLATION

1. Apply a small amount of grease to the threads of each pedal. Look for the letter “L” or “R” on the side or end of each pedal spindle (picture). Turning the spindle clockwise by hand (Picture), thread the pedal marked “R” into the crank arm on the right (drive) side of the bicycle. Make sure that you are not “cross-threading”, which can strip the threads in the crank arm. If the threads do not turn easily, don’t force them. Back the spindle out and start over. Once the pedal is threaded into the crank arm, tighten the spindle securely to the crank arm with a 15mm open end or an adjustable wrench.

2. Turning the spindle counterclockwise by hand, thread the pedal marked “L” into the crank arm on the left side of the bike. Make sure that you are not “cross-threading”, which can strip the threads in the crank arm. If the threads do not turn easily, don’t force them. Back the spindle out and start over. Once the pedal is threaded into the crank arm, tighten the spindle securely to the crank arm with a 15mm open end or an adjustable wrench.

**WARNING! IMPROPERLY INSTALLED AND TIGHTENED PEDALS CAN WORK LOOSE, DAMAGING THE BICYCLE AND CAUSING POSSIBLE SERIOUS INJURY OR DEATH TO THE RIDER**

Torque Requirement 15-18 ft. lbs.

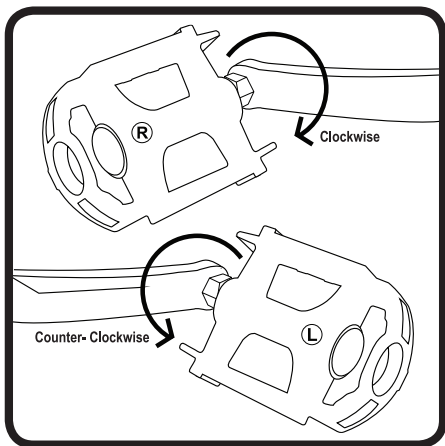



# ASSEMBLING YOUR BIKE

## ADJUSTABLE STEM

1. Remove plastic packaging covering the expander wedge. Loosen the stem expander bolt, if necessary, so the wedge nut is in line with the stem body. See illustration.

2. Insert the stem into the head tube past the minimum insertion line indicated on the stem.

**WARNING: The handlebar stem must be inserted into the head tube until the minimum insertion line indicated on the stem is completely covered.**

3. Face the handlebar stem forward directly in line with the front wheel. **Make sure the fork is in the correct position (facing forward) before tightening the expander bolt.** See illustration.

4. Tighten the expander bolt securely (turning in a clockwise direction). Recommended torque is 20 ft. lbs.

5. **STEM ANGLE ADJUSTMENT.** The stem angle can be adjusted from 90 to 145 degree angle. The adjustment screw is located UNDER the stem extension. You will need a 6mm Allen Wrench. Loosen the 6mm Allen Screw. (DO NOT remove the screw. Loosen it only enough to allow angle adjustment.) Adjust to the desired angle and tighten bolt securely. Check the stem for tightness before riding. **WARNING: The assembler is cautioned against the danger of damaging the handlebar stem assembly and possible injury to the rider in overtightening the expander bolt and expander wedge.**

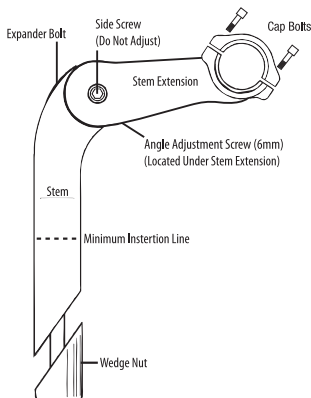

## HANDLEBAR INSTALLATION

1. Loosen the stem clamp bolt.  
2. Insert the handlebar into the stem.  
3. Tighten the stem clamp bolt securely.  
4. Check the handlebar for tightness. If you can move it forward or backward, the clamp bolt is not tight enough.

5. Check steering by straddling the front wheel and trying to turn the handlebar. If you can turn the handlebar without turning the front wheel. The stem is too loose. Align the handlebar with the front wheel. Retighten the expander bolt (clockwise).

Recommended torque is 15 ft. lbs.

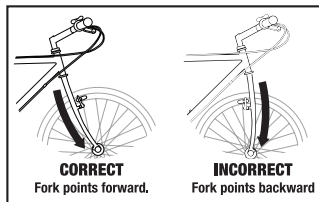

# ASSEMBLING YOUR BIKE

## A-HEAD STEM ASSEMBLY

**⚠️ WARNING! ALWAYS TIGHTEN FASTENERS TO THE CORRECT TORQUE. BOLTS THAT ARE TOO TIGHT CAN DEFORM, BOLTS THAT ARE TOO LOOSE CAN MOVE AND FATIGUE. EITHER MISTAKE CAN LEAD TO LOSS OF CONTROL, SERIOUS INJURY OR DEATH. IF YOU DO NOT FEEL COMFORTABLE WITH YOUR SKILLS IN ASSEMBLING OR ADJUSTING THE BIKE, PLEASE TAKE IT TO A PROFESSIONAL BIKE MECHANIC.**

### (A)

1. Make sure the front fork is facing forward (see illustration).
2. Insert the stem onto the fork steerer tube. Align the steerer tube so that it sits **ABOVE** the top allen screw, but **BELOW** the top of the stem.
3. Tighten the 5mm head set top cap bolt to a torque of 15 ft. lbs. Do Not Overtighten!
4. Face the handlebar stem forward directly in line with the front wheel. Tighten the two 5mm allen screws on the handlebar stem to a torque of 7 ft. lbs.

### (B)

1. Loosen the four locking screws of the stem cap.
2. Adjust the handlebar angle and tighten the four locking screws to a torque of 5.9-8.9 ft.lbs.

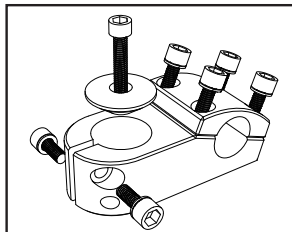
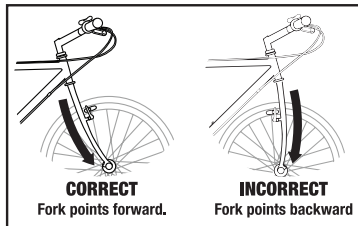
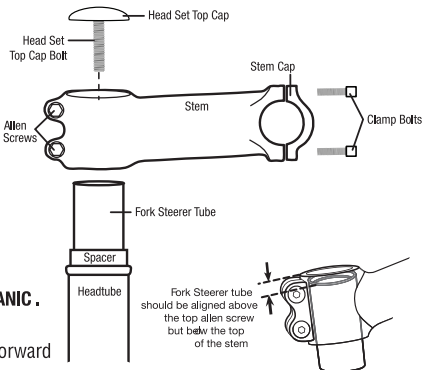

# ASSEMBLING YOUR BIKE

## SEAT & SEAT POST ASSEMBLY

1. Loosen the seat clamp nuts.
2. Insert the top portion of the seat post into the seat clamp. Be sure the seat post is completely inserted into the seat clamp and butted tightly against the underside of the seat.
3. Tighten seat clamp nuts securely.
4. Insert the seat post (with seat attached) into the bike frame. Be sure that the seat post is inserted past the minimum insertion line.
5. Tighten the seat post binder bolt securely at the desired height.
6. Adjust the angle of the seat so that the top of the seat is parallel to the ground or comfortable to the rider.
7. Retighten the seat clamp nuts securely (torque requirement 15-20 ft. lbs). Check for tightness by attempting to twist the seat along with rocking it up and down. If the seat is loose, be sure to tighten the clamp nuts and binder bolt securely.

**▲ THE SEATPOST “MINIMUM INSERTION” / “MAXIMUM HEIGHT” MARK SHOULD NOT BE VISIBLE WHEN THE SEAT POST IS INSERTED INTO THE SEAT MAST OF THE BIKE. DO NOT RAISE THE SEAT POST BEYOND THIS MARK. THE SEAT POST OR FRAME MAY BREAK CAUSING YOU TO LOSE CONTROL AND FALL.**

**ALWAYS CHECK TO MAKE SURE SEAT POST ADJUSTING MECHANISM IS TIGHTENED SECURELY BEFORE RIDING. RIDING WITH AN IMPROPERLY TIGHTENED SEAT POST CAN ALLOW THE SEAT TO TURN OR MOVE AND CAUSE THE RIDER TO LOSE CONTROL**

**SADDLE HEIGHT:** In order to obtain the most comfortable riding position and relation to the rider's leg length. The correct saddle height should not allow leg strain from over-extension, and the hips should not rock from side to side when pedaling. While sitting on the bicycle with one pedal at it's lowest point, place the ball of your foot on the pedal. The correct saddle height will allow the knee to be slightly bent in this position. To obtain maximum comfort, the rider should not over extend his or her reach when riding. There should be a slight bend in the rider's elbows.

# ASSEMBLING YOUR BIKE

## DISC BRAKES

We suggest that if your bike comes equipped with a disc brake that you consult a professional bicycle mechanic for any adjustments or repair needed for this brake.

### SAFETY PRECAUTIONS

1. Adjust the inner cable so that the protruding length is less than 20mm. If the protruding length is any longer, the end of the cable may become stuck in the rotor, which could cause the wheel to lock and the bicycle could fall forward causing injuries.

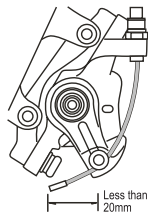

2. The calipers and rotor will become hot when the brakes are operated, so do not touch them while riding or immediately after dismounting from the bicycle, you may get burned. Check that the brake components have cooled down before attempting to adjust the brakes.

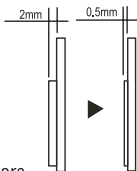

3. Always make sure that the front and rear brakes are working correctly before you ride the bicycle.

4. Before riding the bicycle, check that the pad thicknesses are 0.5mm or more.

5. If noise occurs when the brakes are operated, it may indicate that the brake pads have worn down to their usage limit. After checking that the brake system has cooled down sufficiently, check the brake pad thickness. Replace the brake pads if the wear indicators are visible.

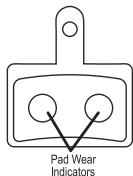

6. Be careful not to allow any oil or grease to get onto the rotor and brake pads, otherwise the brakes may not work correctly.

7. Check the brake cable for rust and fraying, and replace the cable immediately if such problems are found. If this is not done, the brakes may not work correctly.

8. The required braking distance will be longer during wet weather. Reduce your speed and apply the brakes early and gently.

9. If the road surface is wet, the tires will skid more easily. If the tires skid, you may lose control of the bicycle. To avoid this, reduce your speed and apply the brakes gently.

10. Check that the quick release lever is on the right side (the opposite side to the rotor). If the quick release lever is on the same side as the rotor, there is a danger that the lever may interfere with the rotor causing a sudden stop, which may result in a serious accident. Make sure that it does not interfere by rotating the wheel and making sure it rotates freely. Make sure wheel is securely tightened to forks.

# ASSEMBLING YOUR BIKE

## DISC BRAKES *continued*

11. It is important to completely understand the operation of your bicycle's brake system. Improper use of your brake system may result in loss of control or an accident, which could lead to severe injury. Because each bicycle may handle differently be sure to learn proper braking technique (including brake lever pressure and bicycle control characteristics) and operation of your bicycle. This can be done by consulting a professional bicycle mechanic and referring to the disk brake instruction sheet included with your bike. This can also be done by practicing your braking technique in a safe area before hitting the trails.

**CAUTION: Disc brakes have a burn-in period, and the braking force will gradually increase as the burn-in period progresses. Make sure that you are aware of any such increases in braking force when using the brakes during the burn-in period. The same thing will happen when the brake pads or rotor are replaced.**

If the brake cable is not connected at the brake lever, line up brake barrel slot with brake lever slot before installing the cable. Slide the head of the brake cable into the brake lever per the diagram. Thread the cable through the slot in the brake lever so the cable end rests squarely in the adjusting barrel. Turn the adjusting barrel to close.

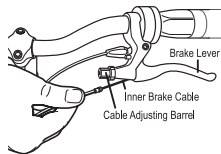

If the brake cable is disconnected at the disc caliper, thread the brake wire through the adjustment barrel, loosen the cable anchor bolt until you can see a hole through the anchor bolt for the cable wire to attach. Thread the cable wire through the cable anchor and tighten by hand.

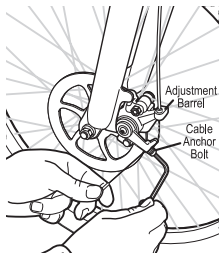

**Centering brake** - First determine if the wheel is centered. Look at the space between the tire and the frame on either side. If it is not even, loosen the wheel axle nuts and center the wheel, then proceed to center the brake.

If the brake is not centered, look at the disc brake caliper for centering adjustment screws at the center of the brake pad on either side. Looking down into the brake where the brake pads contact the disc rotor, determine which side needs to move away or towards the disc. Turn the centering adjustment screws so that there is about 1/32 of an inch of clearance on either side of the disc rotor. Spin the front wheel and listen for any rubbing noise or excess friction. Repeat the steps until the brake is centered.

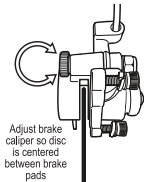

# Installation of the V-BRAKE

1. Insert the stopper pin of the brake body into the center spring hole in the frame mounting boss, and then secure the brake body to the frame with the link fixing bolt.

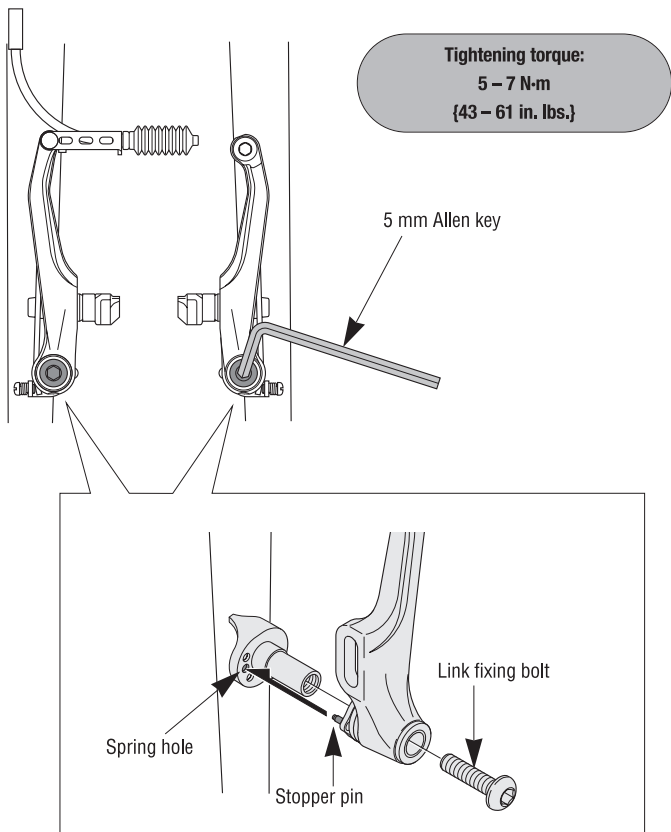

2. While holding the shoe against the rim, adjust the amount of shoe protrusion by changing over the washer B (thick or thin) so that dimension A is kept at 32 mm or more.

(This also applies if the SM-PM40 power modulator is being used.)

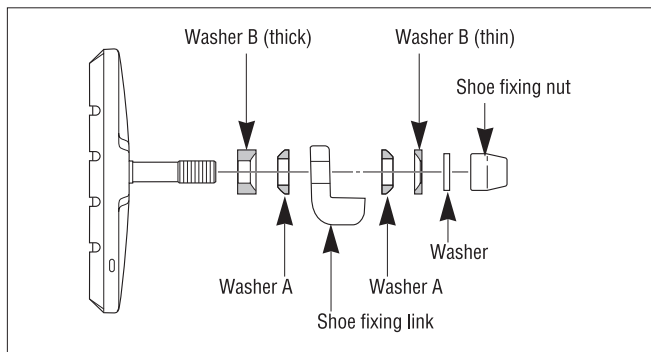
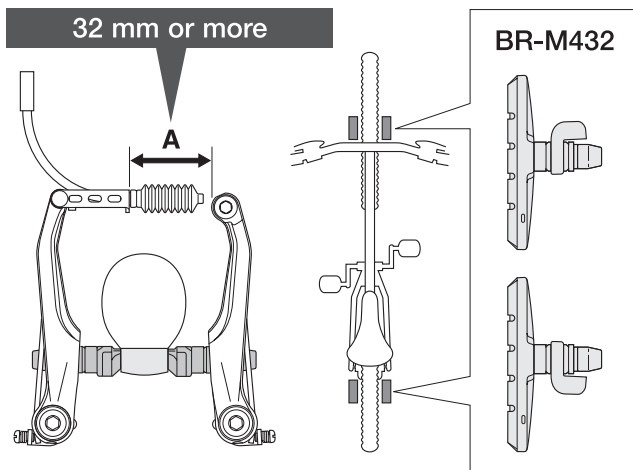

3. While holding the shoe against the rim, tighten the shoe fixing nut.

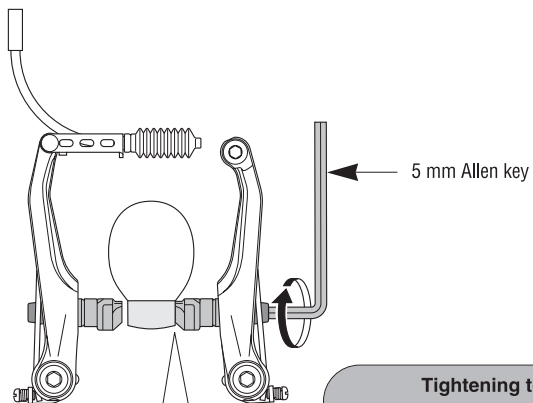

**Tightening torque:**  
6 – 8 N·m {52 – 69 in. lbs.}

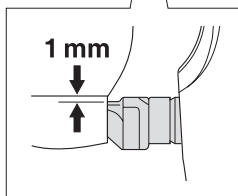



4. Pass the inner cable through the inner cable lead, and after setting so that the total of the clearances between the left and right shoes and the rim is 2 mm, tighten the cable fixing bolt.

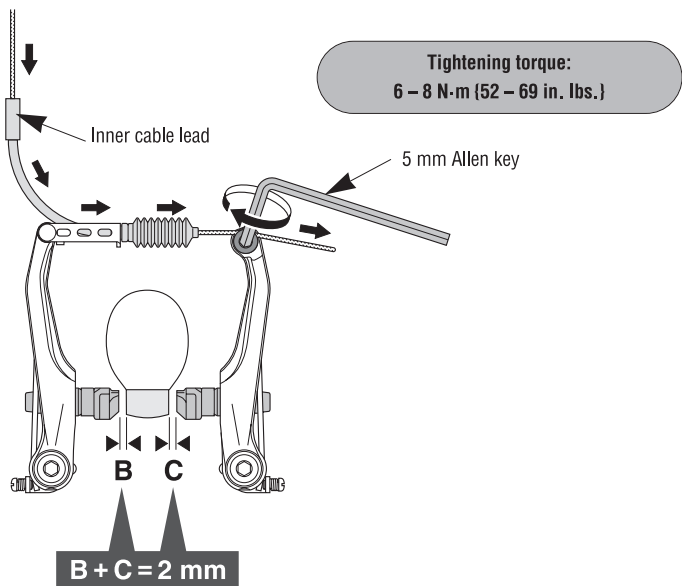

5. Adjust the balance with the spring tension adjustment screws.

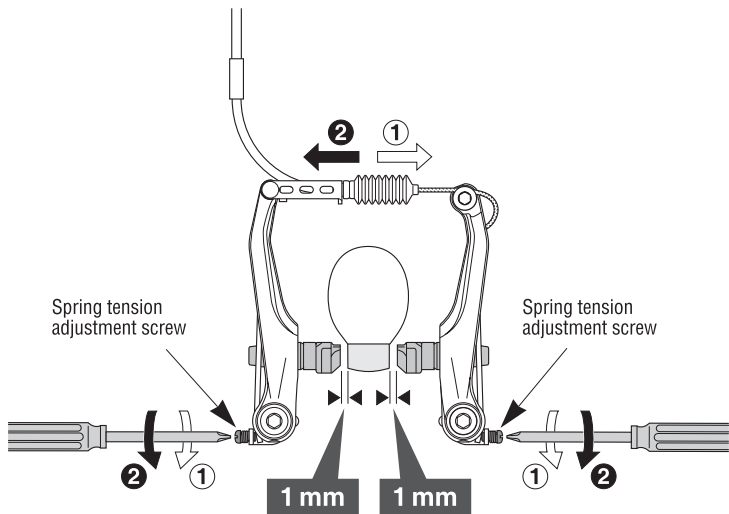

# ASSEMBLING YOUR BIKE

## **DISC BRAKES** *continued*

Brake is adjusted correctly when the brake pads do not drag on the rotor when the brake is open and when applied, the brake pads contact the rim before the brake lever reaches about 1/3 of the way to the handlebar.

After adjusting the brake, reinspect the brake pads, centering, and brake lever travel. If the brake pads are no longer square to the rim, repeat brake pad adjustments. Be sure that the brake pads return to a centered position by spinning the wheel and listening for the brake pad rubbing the rotor on either side. Readjust as needed. Check that the brake cable tension allows the brake lever about 1/3 of the travel before the brake pads contact the rotor. If the cable has stretched or slipped, readjust brake cable tension by loosening the cable anchor bolt and pulling more cable through the anchor or use the brake adjustment barrel for fine tuning the brake cable tension.

 **WARNING! DISC GETS HOT! SEVERE INJURY COULD RESULT FROM CONTACT WITH THE HOT DISC. ALLOW DISC TO COOL COMPLETELY BEFORE TOUCHING.**

# ASSEMBLING YOUR BIKE

## TIRES AND TUBES

After assembling your bike, it will be necessary to inflate the tires. Check the side wall of the tire for the correct tire pressure (PSI) and inflate tires accordingly with a **MANUAL BICYCLE PUMP**. **Improper inflation is the biggest cause of tire failure. Due to the slightly porous nature of bicycle inner tubes, it is normal for your bike tires to lose pressure over time. For this reason it is critically important to maintain the proper tire inflation on your bike.**

1. Your bicycle has been equipped with tires which the bike's manufacturer felt were the best balance of performance and value for the use for which the bike was intended. The tire size and pressure rating are marked on the sidewall of the tire. **CAUTION:** Pencil type automotive tire gauges and gas station air hose pressure settings can be inaccurate and should not be relied upon for consistent, accurate pressure readings. Instead, use a high quality dial gauge.

**⚠ WARNING: NEVER INFLATE A TIRE BEYOND THE MAXIMUM PRESSURE MARKED ON THE TIRE'S SIDEWALL. EXCEEDING THE RECOMMENDED MAXIMUM PRESSURE MAY BLOW THE TIRE OFF THE RIM, WHICH COULD CAUSE DAMAGE TO THE BIKE AND INJURY TO THE RIDER AND OTHERS. THE BEST WAY TO INFLATE A BICYCLE TIRE TO THE CORRECT PRESSURE IS WITH A BICYCLE PUMP. NEVER USE A SERVICE STATION AIR HOSE TO INFLATE A BICYCLE TIRE. IT IS DESIGNED FOR LARGER TIRES AND IT CAN EXCEED THE RECOMMENDED MAXIMUM PRESSURE AND IT MAY BLOW THE TIRE OFF THE RIM.**

Tire pressure is given either as maximum pressure or as a pressure range. How a tire performs under different terrain or weather conditions depends largely on tire pressure. Inflating the tire to near its maximum recommended pressure gives the lowest rolling resistance; but also produces the harshest ride. High pressures work best on smooth, dry pavement. Very low pressures, at the bottom of the recommended pressure range, give the best performance on smooth, slick terrain such as hard-packed clay, and on deep, loose surfaces such as deep, dry sand. Tire pressure that is too low for your weight and the riding conditions can cause a puncture of the tube by allowing the tire to deform sufficiently to pinch the inner tube between the rim and the riding surface.

Some special high-performance tires have unidirectional treads: their tread pattern is designed to work better in one direction than in the other. The sidewall marking of a unidirectional tire will have an arrow showing the correct rotation direction. If your bike has unidirectional tires, be sure that they are mounted to rotate in the correct direction.

2. The tire valve allows air to enter the tire's inner tube under pressure, but doesn't let it back out unless you want it to. There are primarily two kinds of bicycle tube valves: the Schraeder Valve and the Presta Valve. The bicycle pump you use must have the fitting appropriate to the valve stems on your bicycle. The Schraeder is like the valve on a car tire. This is the type of valve stem you should have on your bike. To inflate a Schraeder valve tube, remove the valve cap and push the air hose or pump fitting onto the end of the valve stem. To let air out of a Schraeder valve, depress the pin in the end of the valve stem with the end of a key or other appropriate object.

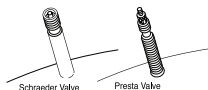

# ASSEMBLING YOUR BIKE

## REFLECTORS

Your bike is supplied with one front reflector (white), one rear reflector (red), two wheel reflectors (white) and four pedal reflectors (orange). These are an important safety and legal requirement, and should remain securely fitted and in good condition at all times. Periodically, inspect all reflectors, brackets and mounting hardware for signs of wear or damage. Replace immediately if damage is found. Some bicycles will require you to install your reflectors onto your bicycle. Please refer to the following section for instructions on all types of bicycle reflectors.

 **WARNING! REFLECTORS ARE IMPORTANT SAFETY DEVICES WHICH ARE DESIGNED AS AN INTEGRAL PART OF YOUR BICYCLE. FEDERAL REGULATIONS REQUIRE EVERY BICYCLE TO BE EQUIPPED WITH FRONT, REAR, WHEEL, AND PEDAL REFLECTORS. THESE REFLECTORS ARE DESIGNED TO PICK UP AND REFLECT STREET LIGHTS AND CAR LIGHTS IN A WAY THAT HELPS YOU TO BE SEEN AND RECOGNIZED AS A MOVING BICYCLIST. CHECK REFLECTORS AND THEIR MOUNTING BRACKETS REGULARLY TO MAKE SURE THEY ARE CLEAN, STRAIGHT, UNBROKEN AND SECURELY MOUNTED. REPLACE DAMAGED REFLECTORS AND STRAIGHTEN OR TIGHTEN ANY THAT ARE BENT OR LOOSE.**

# ASSEMBLING YOUR BIKE

## FORK MOUNT REFLECTORS

First insert one washer onto the hex bolt and insert hex bolt through the reflector bracket and then through the fork. Next, insert a second washer onto the bolt and thread a hex nut onto the bolt behind the fork. Tighten bolts until snug, making sure the reflector is in an upright position.

**CAUTION:** Be sure the reflector is vertical to the ground. If the reflector is aimed up or down, oncoming headlights may not reflect properly in the reflector.

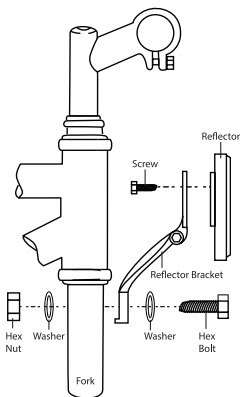

## REAR REFLECTOR MOUNT ON SEAT POST

First attach the reflector to the bracket with the reflector screw. Next, remove the clamp screw and open the clamping reflector bracket. Place clamping reflector bracket around the seat post. If the clamp is too loose, insert the shim inside the clamp. Tighten the clamp screw to hold the reflector assembly in place. Finally adjust the reflector assembly in place and ensure that it is upright and facing away from the bike.

**CAUTION:** Be sure the reflector is vertical to the ground. If the reflector is aimed up or down, oncoming headlights may not reflect properly in the reflector.

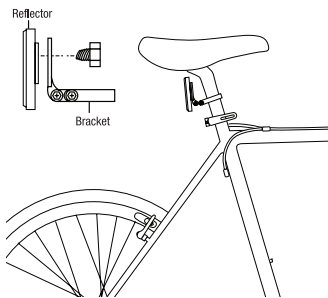

# ASSEMBLING YOUR BIKE

## SHIFTING GEARS

If your bike is a multi-speed bike, please read the information below to familiarize yourself with the basics of shifting gears.

Your multi-speed bicycle will have a derailleur drivetrain (see 1. below), an internal gear hub drivetrain (see 2. below) or, in some special cases, a combination of the two.

### 1. How A Derailleur Drivetrain Works

If your bicycle has a derailleur drivetrain, the gear-changing mechanism will have:

- a rear cassette or freewheel sprocket cluster
- a rear derailleur
- usually a front derailleur
- one or two shifters
- one, two or three front sprockets called chainrings
- a chain

### a. A Brief Note About Shifting Gears

There are several different types and styles of shifting controls: levers, twist grips, triggers, combination shift/brake controls, pushbuttons, and so on. If you are not comfortable shifting gears, ask your local bike mechanic to explain the type of shifting controls that are on your bike, and to show you how they work. The vocabulary of shifting can be pretty confusing. A downshift is a shift to a “lower” or “slower” gear, one which is easier to pedal. An upshift is a shift to a “higher” or “faster”, harder to pedal gear. What’s confusing is that what’s happening at the front derailleur is the opposite of what’s happening at the rear derailleur (for details, read the instructions on Shifting the Rear Derailleur and Shifting the Front Derailleur below). For example, you can select a gear which will make pedaling easier on a hill (make a downshift) in one of two ways: shift the chain down the gear “steps” to a smaller gear at the front, or up the gear “steps” to a larger gear at the rear. So, at the rear gear cluster, what is called a downshift looks like an upshift. The way to keep things straight is to remember that shifting the chain in towards the centerline of the bike is for accelerating and climbing and is called a downshift. Moving the chain out or away from the centerline of the bike is for speed and is called an upshift. Whether upshifting or downshifting, the bicycle derailleur system design requires that the drive chain be moving forward and be under at least some tension. A derailleur will shift only if you are pedaling forward.

**CAUTION: Never move the shifter while pedaling backward, nor pedal backward immediately after having moved the shifter. This could jam the chain and cause damage to the bicycle.**

# ASSEMBLING YOUR BIKE

## b. Shifting The Rear Derailleur

The rear derailleur is controlled by the right shifter. The function of the rear derailleur is to move the drive chain from one gear sprocket to another. The smaller sprockets on the gear cluster produce higher gear ratios. Pedaling in the higher gears requires greater pedaling effort, but takes you a greater distance with each revolution of the pedal cranks. The larger sprockets produce lower gear ratios. Using them requires less pedaling effort, but takes you a shorter distance with each pedal crank revolution. Moving the chain from a smaller sprocket of the gear cluster to a larger sprocket results in a downshift. Moving the chain from a larger sprocket to a smaller sprocket results in an upshift. In order for the derailleur to move the chain from one sprocket to another, the rider must be pedaling forward.

## c. Shifting The Front Derailleur

The front derailleur, which is controlled by the left shifter, shifts the chain between the larger and smaller chainrings. Shifting the chain onto a smaller chainring makes pedaling easier (a downshift). Shifting to a larger chainring makes pedaling harder (an upshift).

## d. Which Gear Should I Be In?

The combination of largest rear and smallest front gears is for the steepest hills; the smallest rear and largest front combination is for the greatest speed. It is not necessary to shift gears in sequence. Instead, find the "starting gear" which is right for your level of ability (a gear which is hard enough for quick acceleration but easy enough to let you start from a stop without wobbling) and experiment with upshifting and downshifting to get a feel for the different gear combinations. At first, practice shifting where there are no obstacles, hazards or other traffic, until you've built up your confidence. Learn to anticipate the need to shift, and shift to a lower gear before the hill gets too steep. If you have difficulties with shifting, the problem could be mechanical adjustment. See your local bike mechanic for help.

**WARNING! NEVER SHIFT A DERAILLEUR TO THE LARGEST OR THE SMALLEST SPROCKET IF THE DERAILLEUR IS NOT SHIFTING SMOOTHLY. THE DERAILLEUR MAY BE OUT OF ADJUSTMENT AND THE CHAIN COULD JAM, CAUSING YOU TO LOSE CONTROL AND FALL.**

**WARNING! DO NOT FORCE THE SHIFT LEVERS. SHIFT ONLY WHEN PEDALING FORWARD AND WITHOUT STRONG FORCE. DO NOT BACKPEDAL. BACKPEDALING AND SHIFTING WHILE NOT PEDALING CAN DAMAGE THE SPROCKETS AND STRETCH THE CABLE WIRE.**

## e. What If It Won't Shift Gears?

If moving the shift control one click repeatedly fails to result in a smooth shift to the next gear chances are that the mechanism is out of adjustment. Take the bike to your bike mechanic to have it adjusted.

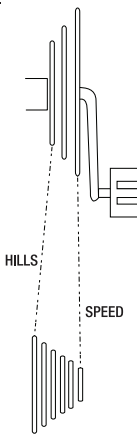



# ASSEMBLING YOUR BIKE

## 2. How An Internal Gear Hub Drivetrain Works

If your bicycle has an internal gear hub drivetrain, the gear changing mechanism will consist of:

- one, or sometimes two shifters
- one or two control cables~ one front sprocket called a chainring
- a drive chain

### a. Shifting Internal Gear Hub Gears

Shifting with an internal gear hub drivetrain is simply a matter of moving the shifter to the indicated position for the desired gear. After you have moved the shifter to the gear position of your choice, ease the pressure on the pedals for an instant to allow the hub to complete the shift.

### b. Which Gear Should I Be In?

The numerically lowest gear (1) is for the steepest hills. The numerically largest gear depending on the number of speeds of your hub, is for the greatest speed. Shifting from an easier, "slower" gear (like 1) to a harder, "faster" gear (like 2 or 3) is called an upshift. Shifting from a harder, "faster" gear to an easier, "slower" gear is called a downshift. It is not necessary to shift gears in sequence. Instead, find the "starting gear" for the conditions

At first, practice shifting where there are no obstacles, hazards or other traffic, until you've built up your confidence. Learn to anticipate the need to shift, and shift to a lower gear before the hill gets too steep. If you have difficulties with shifting, the problem could be mechanical adjustment. **See your local bike mechanic for help.**

### c. What If It Won't Shift Gears?

If moving the shift control one click repeatedly fails to result in a smooth shift to the next gear chances are that the mechanism is out of adjustment. **Take the bike to your local bike mechanic to have it adjusted.**

# OPERATING PROCEDURES

## **START YOUR E-BIKE:**

Power on the ebike by short pressing on/off button on battery (external battery) or on display (internal battery).

Then press the ON/OFF BUTTON on the monitor display for 3 seconds. The monitor display will turn on.

Once monitor display is ON, verify that the Battery Charge Meter shows sufficient charge for your ride. If the battery does not have sufficient charge for your ride, please refer to instructions on how to charge the battery.

Be sure to turn the bike and battery power off when not in use or while recharging.

## **START YOUR RIDE:**

Once you begin riding, you can choose the appropriate assistance level using the INCREASE MOTOR ASSIST [+] or DECREASE MOTOR ASSIST [-] buttons on your display. The motor will assist you once you start pedaling. There are several levels of assistance on the display.

## **NOTES DURING RIDING:**

Frequent braking and again accelerating will deplete the battery faster. The motor will stop assisting once you stop pedaling. Your e-bikes rated maximum load is 220lbs/100kg~265lbs/120kg including the rider, do not overload.



**WARNING:** When stopped, turn off the battery in case the crank arm keeps turning while you push the bike. The motor would start suddenly which may lead to an accident.

**FOR YOUR SAFETY, PLEASE MAINTAIN AND CLEAN YOUR E-BIKE REGULARLY.**

# OPERATING PROCEDURES

## MONITOR DISPLAY:

Your e-bike is equipped with an LCD meter that monitors motor assist, speed, odometer, trip distance, riding time, and battery energy level. To turn the meter on, make sure the battery is charged in the e-bike and the on/off switch is in the ON position.

Press the power on/off button on the button selector located near the left grip on the handlebars to turn the meter on. You can adjust the motor assist power level to have more power by hitting the INCREASE MOTOR ASSIST [+] button and can move to a lower level power by hitting the DECREASE MOTOR ASSIST [-] button.

When first riding your e-bike, you will notice that when the motor assist function is activated, the motor will supply power when you turn the pedals forward.

In different motor assist levels, you will get different assistance power from the motor. When the monitor display is powered off, the bicycle will operate without assistance. Experiment with the different levels of motor assist to become familiar with how much power you want. You will need different levels of assist for different riding conditions.

The bars of the battery charge indicator display the amount of power remaining in the battery. The more bars that are displayed, the more battery power available.

After 5 minutes of inactivity, the monitor display will automatically turn off to conserve power. When not riding the bike, you can turn off the meter by holding down the ON/OFF BUTTON for several seconds.

## FUNCTIONS OF THE MONITOR DISPLAY:

- Battery charge indicator.
- Choosing motor assistance level from LOW to HIGH.
- On/Off Button.
- Level "0" is out of assistance.

# OPERATING PROCEDURES

## HOW TO CHARGE THE BATTERY:

Park the e-bike where an electric socket is available. With the battery off, insert the round charging plug of the charger into the charging hole on your e-bike frame, and then plug the other end into a standard 100-240 volt AC outlet. When the light on charger turns red, the battery is charging. When the charging light turns green, the charging is finished and the battery is fully charged.

It takes upto 3 hours to fully charge a 5.2Ah battery pack, and upto 6 hours to fully charge a 10Ah or 10.2Ah battery pack. When the charging is finished, unplug the electrical plug first, then unplug the charging plug connected to the e-bike, in that sequence.

This is a lithium battery, it has no memory effect, so you can charge or discharge anytime. In normal circumstances, the battery can be used for more than 2 years.

## NOTES FOR CHARGING:

- Make sure to charge your bike before rides. Do not attempt to ride with too little power available.
- PLEASE CHARGE THE BATTERY IN A DRY, WELL VENTILATED AREA WITH ADEQUATE POWER SUPPLY.
- To protect the battery, only use the original charger. Please do not use this charger to charge other e-bike batteries.
- The charger contains high-voltage circuit. Do not dismantle it.
- Only charge the battery while it is switched off.
- Please avoid any liquid or foreign substance from entering the charger. Please protect the charger from impact. Never let it drop or drop objects onto it.
- Do not cover the charger when it is charging.
- Please keep and use our charger in a dry and ventilated area.
- During charging, if the charger emits any smell or it becomes excessively hot, please stop charging and call customer service at 1-800-493-1646.

# OPERATING PROCEDURES

## for multi-speeds e-bike only

### SHIFTING GEARS:

Your bike is equipped with multi-speeds. The first gear is for easier and uphill pedaling, and the last gear is for maximum speed on level or downhill terrain. Change gears only while pedaling. The rear wheel contains chain sprockets. When the chain is around the largest sprocket, you are in 1st gear, or the lowest gear. The high gear will have the derailleur positioned so that the chain is directed around the smallest gear. Every position on the gear selector should cause a gear change. Adjustments require fine tuning and should only be made by a qualified technician.

**NOTE:** Avoid changing gears very rapidly from first gear to the last gear or vice versa. If you change multiple gears too quickly, you could have the chain come off the front sprocket.



**WARNING: ONLY SHIFT GEARS WHILE PEDALING!** Shifting gears while using only the motor assist or when the bike is stationary can cause the chain to become loose or come off the bike.

# MONITOR DISPLAY

Your new e-bike is equipped with a Monitor Display. This monitor display is powered by the bike's battery. The bike must be powered on for the monitor display to function.

## **TURNING THE MONITOR DISPLAY ON:**

To power on the monitor display, press and hold the ON/OFF BUTTON. To turn the monitor display off, press and hold the ON/OFF BUTTON. **PLEASE NOTE: When the bike is not used for 5 consecutive minutes, the monitor display and the power supply will automatically shut off.**

## **ENGAGING THE MOTOR ASSIST FUNCTION:**

To engage and select the motor assist function, press the INCREASE MOTOR ASSIST [+] or DECREASE MOTOR ASSIST [-] and choose your level of assistance. Motor assistance is available in different levels.

Level 1 is minimum assistance, the level is higher, the motor assistance will be more. The assistance level will reset when the bike and monitor are powered off.

Level "0" is out of assistance.

# MAINTENANCE/REPAIR

**Correct routine maintenance of your new bike will ensure a longer life for your bike and a safer ride for you.**

Every time you ride your bike, its condition changes. The more you ride, the more frequently maintenance will be required. We recommend you spend a little time on regular maintenance tasks. The following schedules will assist you in knowing what tasks need to be performed and how often. If you have any doubts about your abilities to accomplish these tasks, we recommend you take your bike to a professional bicycle mechanic periodically to have them done.

## Schedule 1 - Lubrication

Frequency	Component	Lubricant	How to Lubricate
Weekly	chain derailleur wheels	chain lube or light oil chain lube or light oil	brush on or squirt brush on or squirt
Monthly	derailleurs brake calipers brake levers shift levers	oil oil oil lithium based grease	oil can 3 drops from oil can 2 drops from oil can disassemble
Every Six Months	freewheel brake cables	oil lithium based grease	2 drops from oil can disassemble
Yearly	Bottom bracket pedals derailleur cables wheel bearings headset seat pillar	lithium based grease lithium based grease lithium based grease lithium based grease lithium based grease lithium based grease	Bicycle Mechanic disassemble disassemble Bicycle Mechanic Bicycle Mechanic disassemble

**Note: The frequency of maintenance should increase with use in wet or dusty conditions. Do not over lubricate - remove excess lubricant to prevent dirt build up. Never use a degreaser to lubricate your chain (WD-40™)**



**CAUTION: CALL CUSTOMER SERVICE AT 1-800-493-1646 OR  
CONSULT A PROFESSIONAL BICYCLE MECHANIC WITH ANY  
QUESTIONS ON REPAIRS OR MAINTENANCE.**



# MAINTENANCE/REPAIR

## SERVICE CHECKLIST:

Frequency	Task
Before every ride	Check wheel and pedal tightness Check tire pressure Check brake operation Check wheels for loose spokes, loose axle nuts or quick release Make sure all fasteners are tightened securely
After every ride	Quick wipe down with damp cloth
Weekly	Lubrication as per schedule 1
Monthly	Lubrication as per schedule 1 Check derailleur adjustment Check brake adjustment Check brake and gear cable adjustment Check tire wear and pressure Check wheels are true and spokes tight Check hub, head set and crank bearings for looseness Check pedals are tight Check handlebars are tight Check seat and seat post are tight and comfortably adjusted Check frame and fork for trueness Check all nuts and bolts are tight
Every six months	Lubrication as per schedule 1 Check all points as per monthly service Check and replace brake pads, if required Check chain for excess play or wear
Yearly	Lubrication as per schedule 1



**CAUTION: CALL CUSTOMER SERVICE AT 1-800-493-1646 OR  
CONSULT A PROFESSIONAL BICYCLE MECHANIC WITH ANY  
QUESTIONS ON REPAIRS OR MAINTENANCE.**





# MAINTENANCE/REPAIR

## TOOLS REQUIRED FOR MAINTENANCE:

1. Open ended wrench or box wrenches: 8mm, 9mm, 10mm, 12mm, 13mm, 14mm, 15mm
2. Open end or pedal wrench 15mm
3. Allen key wrenches: 4mm, 5mm, 6mm, 8mm
4. Adjustable wrench
6. Standard Phillips head screwdriver
7. Standard slip joint pliers
8. Tire pump
9. Tube repair kit
10. Tire levers

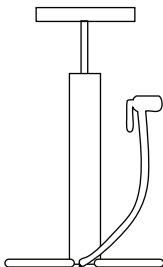

## TRAVEL TOOLS:

We suggest you take the following items with you when going on a long bike ride. Tools should be fully secured in a sturdy bag or container attached to the seat or frame of the unit during travel:

1. Spare tube
2. Patch kit
3. Pump
4. Tire levers
5. Multi-tool
6. Cell phone or change for a pay phone

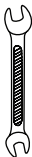

**CAUTION: CALL CUSTOMER SERVICE AT 1-800-493-1646 OR  
CONSULT A PROFESSIONAL BICYCLE MECHANIC WITH ANY  
QUESTIONS ON REPAIRS OR MAINTENANCE.**



# MAINTENANCE/REPAIR

## WHEEL INSPECTION:

It is most important that wheels are kept in top condition. Properly maintaining your bicycle's wheels will help braking performance and stability when riding. Be aware of the following potential problems:

- **Dirty or greasy rims:**

**Caution:** These can render your brakes ineffective. Do not clean them with oily or greasy materials. When cleaning, use a clean rag or wash with soapy water, rinse and air dry. Don't ride while they're wet. When lubricating your bicycle, don't get oil on the rim braking surfaces.

- **Wheels not straight:**

Lift each wheel off the ground and spin them to see if they are crooked or out of true. If wheels are not straight, they will need to be adjusted. This is quite difficult and is best left to a professional bicycle mechanic.

- **Broken or loose spokes:**

Check that all spokes are tight and that none are missing or damaged.

**Caution: Such damage can result in severe instability and possibly an accident if not corrected. Again, spoke repairs are best handled by a mechanic.**

- **Loose hub bearings:**

Lift each wheel off the ground and try to move the wheel from side to side. Caution: If there is movement between the axle and the hub, do not ride the bicycle. Adjustment is required.

- **Axle nuts:**

Check that these are tight before each ride.



**CAUTION: CALL CUSTOMER SERVICE AT 1-800-493-1646 OR  
CONSULT A PROFESSIONAL BICYCLE MECHANIC WITH ANY  
QUESTIONS ON REPAIRS OR MAINTENANCE.**



# MAINTENANCE/REPAIR

## TIRE INSPECTION:

Tires must be maintained properly to ensure road holding and stability. Check the following areas:

- **Inflation:**

Ensure tires are inflated to the pressure indicated on the sidewall of the tire. Improper inflation is the biggest cause of tire failure. Due to the slightly porous nature of bicycle inner tubes, it is normal for your tires to lose pressure over time. For this reason, it is critically important to maintain the proper tire inflation on your bike. **Caution: Use a hand or foot pump to inflate tires. NEVER inflate tires with an air compressor at a gas station. This can cause the tubes to over inflate and blowout.**

- **Bead Seating:**

When inflating or refitting the tire, make sure that the bead is properly seated in the rim.

- **Tread:**

Check that the tread shows no signs of excessive wear or flat spots, and that there are no cuts or other damage.

**CAUTION: Excessively worn or damaged tires should be replaced.**

- **Valves:**

Make sure valve caps are fitted and that valves are free from dirt. A slow leak caused by the entry of dirt can lead to a flat tire and possibly a dangerous situation.

## RECOMMENDED TIRE PRESSURES:

The recommended pressure is molded on the sidewall of your bicycle tires.



**CAUTION: CALL CUSTOMER SERVICE AT 1-800-493-1646 OR  
CONSULT A PROFESSIONAL BICYCLE MECHANIC WITH ANY  
QUESTIONS ON REPAIRS OR MAINTENANCE.**



# MAINTENANCE/REPAIR

## HOW TO FIX A FLAT TIRE : If you need to repair a tire, follow these steps:

1. Remove the wheel from the bicycle.
2. Deflate the tire completely via the valve. Loosen the tire bead by pushing it inward all the way around.
3. Press one side of the tire bead up over the edge of the rim. Note: Use tire levers, not a screwdriver, otherwise you may damage the rim.
4. Remove the tube, leaving the tire on the rim.
5. Locate the leaks and patch using a tube repair kit or replace the tube. Note: Ensure that the replacement tube size matches the size stated on the tire sidewall and that the valve is the correct type for your bicycle.
6. Match the position of the leak in the tube with the tire to locate the possible cause and mark the location on the tire.
7. Remove the tire completely and inspect for a nail, glass, etc. and remove if located. Also inspect the inside of the rim to ensure there are no protruding spokes, rust or other potential causes. Replace the rim tape which covers the spoke ends.
8. Remount one side of the tire onto the rim.
9. **Using a hand pump**, inflate the tube just enough to give it some shape.
10. Place the valve stem through the hole in the rim and work the tube into the tire.  
NOTE: Do not let it twist.
11. Using your hands only, remount the other side of the tire by pushing the edge toward the center of the rim. Start on either side of the valve and work around the rim.
12. Before the tire is completely mounted, push the valve up into the rim to make sure the tire can sit squarely in position.
13. Fit the rest of the tire, rolling the last, most difficult part on using your thumbs.  
NOTE: Avoid using tire levers as these can easily puncture the tube or damage the tire.
14. Check that the tube is not caught between the rim and the tire bead at any point.
15. **Using a hand pump**, inflate the tube until the tire begins to take shape. Check that the tire bead is evenly seated all the way around the rim. When properly seated, fully inflate the tire to the pressure marked on the sidewall.
16. Replace the wheel into the frame checking that all gears, brakes and quick release levers are properly adjusted.



**CAUTION: CALL CUSTOMER SERVICE AT 1-800-493-1646 OR  
CONSULT A PROFESSIONAL BICYCLE MECHANIC WITH ANY  
QUESTIONS ON REPAIRS OR MAINTENANCE.**



# MAINTENANCE/REPAIR

## DERAILLEUR SYSTEMS:

The derailleur system consists of the rear derailleur, the shift lever, and the derailleur control cables, all of which must function correctly for smooth gear shifting to occur. There are several different types of derailleur systems but all operate using similar principles. Your new bicycle is fitted with an “index” system (e.g. SIS) which links each different gear position to a positive click mechanism in the shifter, and makes shifting simple and precise.

## INSPECTION:

The operation of the derailleur system should be checked at the start of each ride and thoroughly checked at least every month.

Check the operation of the derailleur first. The rear derailleur should shift the chain cleanly from one cog to the next without hesitation. Each notched position in the shifter equates to a new gear position. After shifting, the rear derailleur should not rub on the chain.

The derailleur should never cause the chain to fall off the inner or outer freewheel cogs.

Derailleur control cables are a critical component that must be well maintained for accurate shifting performance. Check them for any sign of rust, fraying, kinks, broken strands, and any damage to the cable housing. If you find any problems, the cables or other involved components should be evaluated as it may need replacing before you ride.

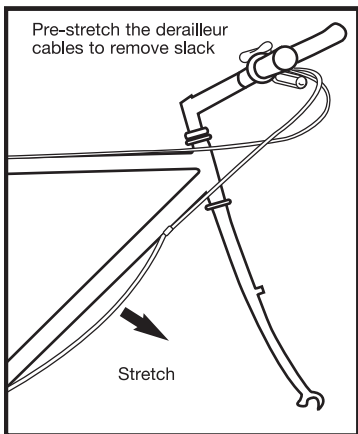

**CAUTION: CALL CUSTOMER SERVICE AT 1-800-493-1646 OR  
CONSULT A PROFESSIONAL BICYCLE MECHANIC WITH ANY  
QUESTIONS ON REPAIRS OR MAINTENANCE.**



# MAINTENANCE/REPAIR

## REAR DERAILLEUR ADJUSTMENT:

The Low Gear Adjustment Screw (A) determines how far the rear derailleur will travel toward the wheel of the bicycle, while the High Gear Adjustment Screw (B) determines how far the cage will travel toward the frame.

1. Shift the rear shifter to the largest number indicated, disconnect the rear derailleur cable from the cable anchor bolt and place the chain on the smallest sprocket.
2. Adjust the High Gear Adjustment Screw (B) so the chain and the smallest sprocket are lined up vertically. Remove any slack in the cable by pulling it taut, then re-connect the cable and tighten the cable anchor bolt securely.
3. Some derailleurs have an adjusting barrel. Use the adjusting barrel and turn clockwise to move the derailleur outboard - away from the wheel - while turning it counter-clockwise will direct the chain inboard - towards the wheel.
4. Shift the chain onto the largest sprocket; adjust the Low Gear Adjustment Screw (A) so the chain and the largest cog are lined up vertically. If you are unable to get the chain to the largest cog, turning the Low Gear Adjustment Screw (A) counter-clockwise will enable the chain to move towards the wheel.
5. Shift through the gears ensuring each gear is achieved quietly and without hesitation.

**NOTE:** It may take several adjustments to achieve the desired positioning. Please refer to the troubleshooting section for more assistance. Check to be sure how the components on your bike function.

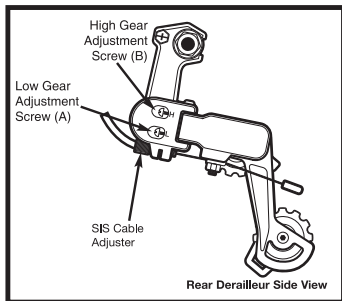

**CAUTION: CALL CUSTOMER SERVICE AT 1-800-493-1646 OR CONSULT A PROFESSIONAL BICYCLE MECHANIC WITH ANY QUESTIONS ON REPAIRS OR MAINTENANCE.**



# MAINTENANCE/REPAIR

## DERAILLEUR LUBRICATION:

All the pivoting points of the derailleur should be lubricated with light oil at least every month. Be sure to wipe off any excess oil to prevent attraction of dirt into the mechanisms. The shifting cables should be cleaned and re-coated with a thin layer of grease every six months, or whenever new cables are being installed.

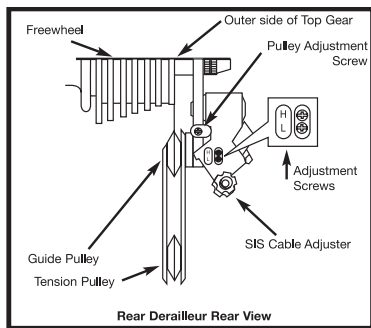

## FREEWHEEL INSPECTION:

Like the chain, the freewheel must be kept clean and well lubricated using light oil in small quantities. If the chain has become worn and needs replacing, then it is likely that the freewheel will also have become worn and should be carefully checked and also be replaced. Take the chain off the freewheel and rotate it with your hand. If you hear a grinding noise or the freewheel stops suddenly after spinning it, it may need adjustment or replacement. Such action is beyond the scope of this manual and you should consult a professional bicycle mechanic.

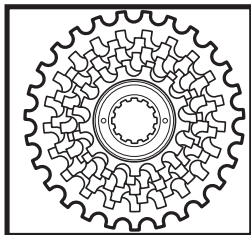

**CAUTION: CALL CUSTOMER SERVICE AT 1-800-493-1646 OR  
CONSULT A PROFESSIONAL BICYCLE MECHANIC WITH ANY  
QUESTIONS ON REPAIRS OR MAINTENANCE.**



# MAINTENANCE/REPAIR

**PEDAL INSPECTION:** Pedals should be inspected every month, taking note of the following areas:

- Check that the pedals are tightened securely against the crank arm. If pedals are allowed to become loose, they will not only be dangerous to the rider but will also cause irreparable damage to the mating threads of the cranks.
- Check that pedal bearings are properly functioning. Move the pedals up and down, and right to left, and also rotate them by hand. If you detect any looseness or roughness in the pedal bearings then lubrication or replacement is required. Check your pedals to see if adjustment is possible to correct the looseness.
- Ensure that the front and rear pedal reflectors on each pedal are clean, not cracked, and securely fitted.



**WARNING! Never ride with loose pedals. Improperly installed or tightened pedals can work loose, damaging the bicycle and causing possible serious injury or death to the rider.**



**Always wear solid, well-constructed shoes while riding.**



**CAUTION: CALL CUSTOMER SERVICE AT 1-800-493-1646 OR  
CONSULT A PROFESSIONAL BICYCLE MECHANIC WITH ANY  
QUESTIONS ON REPAIRS OR MAINTENANCE.**





# MAINTENANCE/REPAIR

**PEDAL LUBRICATION AND ADJUSTMENT:** Many pedals cannot be disassembled to allow access to the internal bearings and axle. However, it is usually possible to inject a little oil onto the inside bearings, and this should be done every six months. If the pedal is the type that can be fully disassembled, then the bearings should be removed, cleaned and greased every six to twelve months. Because of the wide variety of pedal types and their internal complexity, disassembly procedures are beyond the scope of this manual and further assistance should be sought from a professional bicycle mechanic.

**PEDAL ATTACHMENT - Note:** The right and left pedals of a bicycle each have a different thread and are not interchangeable. Never force a pedal into the incorrect crank arm. Check for the right (R) and left (L) letters on each pedal bolt end. Not all crank arms are marked but the right pedal crank arm is on the right side of the bike with a rider in normal riding position and the left crank arm is located on the left side of the bike. Match the appropriate pedal to each crank (right to right and left to left) for assembly. Insert the correct pedal into the crank arm and begin to turn the thread with your fingers only. When the axle is screwed in substantially all the way then securely tighten using a 15mm narrow open-ended wrench so that the shoulder of the pedal spindle is securely tightened against the crank arm. If removing a pedal, remember that the right pedal axle must be turned counter clockwise, i.e. the reverse of when fitting.

If replacing the original pedals with a new set, make sure the size and the axle thread is compatible with the cranks on your bicycle.

**NOTE:** Never try and force a pedal with the wrong thread size into a bicycle crank. If the pedal is too loose or too tight, it is the wrong pedal and might come loose in use.



**CAUTION: CALL CUSTOMER SERVICE AT 1-800-493-1646 OR  
CONSULT A PROFESSIONAL BICYCLE MECHANIC WITH ANY  
QUESTIONS ON REPAIRS OR MAINTENANCE.**



# MAINTENANCE/REPAIR

## CHAIN INSPECTION:

The chain on your bicycle must be kept clean, rust free and frequently lubricated in order to have the best possible performance when riding and extend its life as long as possible. It will require replacement if it stretches, wears, breaks, or causes inefficient gear shifting due to excessive dirt or debris embedded in the chain. Make sure that there are no stiff links; they must all move freely to seat and shift properly.

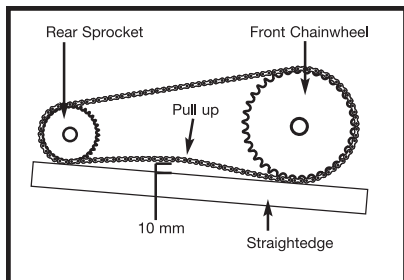

## CHAIN LUBRICATION:

The chain should be lubricated with light oil at least every month, or after use in wet, muddy, or dusty conditions. Take care to clean the chain of debris before lubrication. After lubrication, wipe off excess oil. **NOTE:** Do not get oil on the tires or rim braking surfaces.

## CHAIN ADJUSTMENT AND REPLACEMENT:

On derailleur geared bicycles, the rear derailleur automatically tensions the chain. To adjust the chain:

1. Loosen the rear axle nuts (and coaster brake arm clip if fitted) and move the wheel forward to loosen, or backward to tighten the chain, in the frame.
2. When correctly adjusted, the chain should have approximately 10mm of vertical movement when checked in the center between the chainwheel and rear sprocket.

Chains require a special tool to fit and remove damaged chain links, or to change the length.

**We recommend that you consult a professional bicycle mechanic to replace or change the length of your chain. They will have the special tools required to perform the repairs correctly.**



**CAUTION: CALL CUSTOMER SERVICE AT 1-800-493-1646 OR  
CONSULT A PROFESSIONAL BICYCLE MECHANIC WITH ANY  
QUESTIONS ON REPAIRS OR MAINTENANCE.**



# MAINTENANCE/REPAIR

## **BATTERY AND CHARGER CARE:**

The charger will charge a fully depleted battery in 5-6 hours. The indicator light on the charger will be red / orange when the discharged battery is charging. The indicator light will turn green when the battery is fully charged. Avoid subjecting the battery to high temperatures, such as direct sun, for prolonged periods of time.

Recharge the battery before it becomes completely discharged. Completely discharging will reduce the numbers of recharging cycles during the battery's life and limit the capacity. Never store the battery in a discharged state.

After much use, your battery's charge-holding capacity will decrease. If you find that your battery does not hold a sufficient charge, please call customer service at 800-451-5368.

Some owners find it convenient to have 2 batteries to avoid being out of service for 5-6 hours. If the battery will not be used for an extended period of time, charge it fully and recharge it every 3-6 months. Store it in a cool, dry place. Your battery is engineered with precision for high capacity and a long, useful life. If you experience unusual sounds or odors coming from the charger or the battery, unplug the charger and battery immediately and contact customer service.

Clean visible oxidation from the plugs and metallic parts. Change to a different outlet if the plug becomes hot during charging. Over-heating from a battery's ability to hold a full charge may lead to a short circuit and damage your charger, battery, and unit.



**CAUTION: CALL CUSTOMER SERVICE AT 1-800-493-1646 OR  
CONSULT A PROFESSIONAL BICYCLE MECHANIC WITH ANY  
QUESTIONS ON REPAIRS OR MAINTENANCE.**



# MAINTENANCE/REPAIR

## CHARGER:

Included with your new e-bike is a lithium ion battery, along with a charger, which plugs into a standard household electric receptacle.

A lithium ion battery requires specially designed chargers. You should never charge your battery with a substitute charger that is not designed for this use. Use of an unsuitable charger to charge a lithium ion battery could result in over-heating, fire or even explosion.

- Recharge battery after every use.
- Do not disassemble or alter the battery or battery charger.
- Do not place the battery near fire or corrosive substances.
- Do not allow any liquids on or inside the battery/charger.
- Do not expose the battery/charger to extreme weather conditions.
- Do not operate the battery/charger if damaged.
- Recharge the battery only with a charger specified by the manufacturer.
- Do not use the battery/charger for any use other than its intended purpose.
- Only use the battery/charger on approved products.



**CAUTION: CALL CUSTOMER SERVICE AT 1-800-493-1646 OR  
CONSULT A PROFESSIONAL BICYCLE MECHANIC WITH ANY  
QUESTIONS ON REPAIRS OR MAINTENANCE.**



# MAINTENANCE/REPAIR

## APPEARANCE CARE :

Periodically clean your electric bike with a damp cloth. Avoid spraying the e-bike with a water hose to avoid electrical issues. Store your e-bike in a dry shelter area away from direct sunlight and wet or damp environment. It is also recommended to apply chain lube to the drive-train of your e-bike when you clean it or wipe it down to keep it in good running condition.

## NOTE:

- Washing your e-bike with a hose or high pressure hose is not possible, because it will cause failure or even accidents caused by damage of electronic components and circuits. Do not rinse the electrical parts of your e-bike, use a moist cloth only.
- Please use natural detergents and use a rag to clean its surface gently, finally clean the bike with a dry cloth.



**CAUTION: CALL CUSTOMER SERVICE AT 1-800-493-1646 OR  
CONSULT A PROFESSIONAL BICYCLE MECHANIC WITH ANY  
QUESTIONS ON REPAIRS OR MAINTENANCE.**



# TROUBLESHOOTING

<b>Problem</b>	<b>Possible Cause</b>	<b>Remedy</b>
Gear shifts not working properly	<ul style="list-style-type: none"><li>- Derailleur cables sticking/stretched/damaged</li><li>- Rear derailleur not adjusted properly</li><li>- Indexed shifting not adjusted properly</li></ul>	<ul style="list-style-type: none"><li>- Lubricate/tighten/clean replace cables</li><li>- Adjust derailleur</li><li>- Adjust indexing</li><li>- Seek advice from your dealer</li></ul>
Slipping chain	<ul style="list-style-type: none"><li>- Excessively worn/chipped chainring or freewheel sprocket teeth</li><li>- Chain worn/stretched</li><li>- Stiff link in chain</li><li>- Non compatible chain/chainring / freewheel</li></ul>	<ul style="list-style-type: none"><li>- Replace chainring and sprockets</li><li>- Replace chain</li><li>- Lubricate or replace master link</li><li>- Seek advice from your dealer</li></ul>
Chain jumping off freewheel sprocket or chainring	<ul style="list-style-type: none"><li>- Chainring out of true</li><li>- Chainring loose</li><li>- Chainring teeth bent or broken</li><li>- Rear derailleur side-to-side travel out of adjustment</li></ul>	<ul style="list-style-type: none"><li>- Re-true if possible, or replace</li><li>- Tighten mounting bolts</li><li>- Repair or replace chainring/set</li><li>- Adjust derailleur travel</li></ul>
Constant clicking noises when pedaling	<ul style="list-style-type: none"><li>- Stiff chain link</li><li>- Loose pedal axle/bearings</li><li>- Loose bottom bracket axle/bearings</li><li>- Bent bottom bracket or pedal axle</li><li>- Loose crankset</li></ul>	<ul style="list-style-type: none"><li>- Lubricate chain / Adjust chain link</li><li>- Adjust bearings/axle nut</li><li>- Adjust bottom bracket</li><li>- Replace bottom bracket axle or pedals</li><li>- Tighten crank bolts</li></ul>
Grinding noise when pedaling	<ul style="list-style-type: none"><li>- Pedal bearings too tight</li><li>- Bottom bracket bearings too tight</li><li>- Chain fouling derailleurs</li><li>- Derailleur jockey wheels dirty/binding</li></ul>	<ul style="list-style-type: none"><li>- Adjust bearings</li><li>- Adjust bearings</li><li>- Adjust chain line</li><li>- Clean and lubricate jockey wheels</li></ul>



**CAUTION: CALL CUSTOMER SERVICE AT 1-800-493-1646 OR CONSULT A PROFESSIONAL BICYCLE MECHANIC WITH ANY QUESTIONS ON REPAIRS OR MAINTENANCE.**



# TROUBLESHOOTING

<b>Problem</b>	<b>Possible Cause</b>	<b>Remedy</b>
Freewheel does not rotate	<ul style="list-style-type: none"><li>- Freewheel internal pawl pins are jammed</li></ul>	<ul style="list-style-type: none"><li>- Lubricate. If problem persists, replace freewheel</li></ul>
Brakes not working effectively	<ul style="list-style-type: none"><li>- Brake blocks worn down</li><li>- Brake blocks/rim greasy, wet or dirty</li><li>- Brake cables are binding/ stretched/damaged</li><li>- Brake levers are binding</li><li>- Brakes out of adjustment</li></ul>	<ul style="list-style-type: none"><li>- Replace brake blocks</li><li>- Clean blocks and rim</li><li>- Clean/adjust/replace cables</li><li>- Adjust brake levers</li><li>- Center brakes</li></ul>
When applying the brakes they squeal/ squeak	<ul style="list-style-type: none"><li>- Brake blocks worn down</li><li>- Brake block toe-in incorrect</li><li>- Brake blocks/rim dirty or wet</li><li>- Brake arms loose</li></ul>	<ul style="list-style-type: none"><li>- Replace blocks</li><li>- Correct block toe-in</li><li>- Clean blocks and rim</li><li>- Tighten mounting bolts</li></ul>
Knocking or shuddering when applying brakes	<ul style="list-style-type: none"><li>- Bulge in the rim or rim out of true</li><li>- Brake mounting bolts loose</li><li>- Brakes out of adjustment</li><li>- Fork loose in head tube</li></ul>	<ul style="list-style-type: none"><li>- True wheel or take to a bike shop for repair</li><li>- Tighten bolts</li><li>- Center brakes and/or adjust brakeblock toe-in</li><li>- Tighten headset</li></ul>
Wobbling Wheel	<ul style="list-style-type: none"><li>- Axle broken</li><li>- Wheel out of true</li><li>- Hub comes loose</li><li>- Headset binding</li><li>- Hub bearings collapsed</li><li>- QR mechanism loose</li></ul>	<ul style="list-style-type: none"><li>- Replace axle</li><li>- True wheel</li><li>- Adjust hub bearings</li><li>- Adjust headset</li><li>- Replace bearings</li><li>- Adjust QR mechanism</li></ul>



**CAUTION: CALL CUSTOMER SERVICE AT 1-800-493-1646 OR CONSULT A PROFESSIONAL BICYCLE MECHANIC WITH ANY QUESTIONS ON REPAIRS OR MAINTENANCE.**



# TROUBLESHOOTING

Problem	Possible Cause	Remedy
Steering not accurate	<ul style="list-style-type: none"><li>- Wheels not aligned in frame</li><li>- Headset loose or binding</li><li>- Front forks or frame bent</li><li>- Stem wedge bolt not tight</li></ul>	<ul style="list-style-type: none"><li>- Align wheels correctly</li><li>- Adjust/tighten headset</li><li>- Take bike to a bike shop for possible frame realignment</li><li>- Tighten stem bolt</li></ul>
Frequent punctures	<ul style="list-style-type: none"><li>- Inner tube old or faulty</li><li>- Tire tread/casing worn</li><li>- Tire unsuited to rim</li><li>- Tire not checked after previous puncture</li><li>- Tire pressure too low</li><li>- Spoke protruding into rim</li></ul>	<ul style="list-style-type: none"><li>- Replace Inner tube</li><li>- Replace tire</li><li>- Replace with correct tire</li><li>- Remove sharp object embedded in tire</li><li>- Correct tire pressure</li><li>- File down spoke</li></ul>
Problem	Possible Cause	Remedy
Motor is not working	<ul style="list-style-type: none"><li>- Run out of battery</li><li>- Controller is broken</li><li>- Motor was too hot</li></ul>	<ul style="list-style-type: none"><li>- Charge the battery</li><li>- Repair or replace motor or battery</li><li>- Wait a few minutes</li></ul>
Motor works intermittently	<ul style="list-style-type: none"><li>- The connector of motor is loose</li><li>- Voltage of the battery is too low, the controller starts low-voltage protection</li></ul>	<ul style="list-style-type: none"><li>- Reconnect the motor</li><li>- Charge the battery or replace the battery</li></ul>
Motor is powerless	<ul style="list-style-type: none"><li>- Line resistance is too huge</li><li>- Voltage of the battery is too low</li><li>- Motor is damaged</li></ul>	<ul style="list-style-type: none"><li>- Check and repair the circuit</li><li>- Charge the battery or replace with a new one</li><li>- Replace the motor</li></ul>



**CAUTION: CALL CUSTOMER SERVICE AT 1-800-493-1646 OR CONSULT A PROFESSIONAL BICYCLE MECHANIC WITH ANY QUESTIONS ON REPAIRS OR MAINTENANCE.**





# TROUBLESHOOTING

<b>Problem</b>	<b>Possible Cause</b>	<b>Remedy</b>
Short time of charge and discharge of battery	<ul style="list-style-type: none"><li>- Decline of battery capacity</li></ul>	<ul style="list-style-type: none"><li>- Replace the battery</li></ul>
The light on charger is not working	<ul style="list-style-type: none"><li>- Fuse for input in charger is broken</li><li>- Loose power supply at the socket</li><li>- The connector of indicator light is loose</li><li>- The indicator light is broken</li></ul>	<ul style="list-style-type: none"><li>- Change fuse</li><li>- Check the outlet, make sure power is there</li><li>- Reconnect</li><li>- Replace indicator light</li></ul>
The green light is not lit after 5 hours of charging	<ul style="list-style-type: none"><li>- The charging voltage is too high</li><li>- Battery is damaged</li><li>- The indicator light is broken</li></ul>	<ul style="list-style-type: none"><li>- Replace the charger</li><li>- Replace the battery</li><li>- Replace indicator light</li></ul>
Red and green lights go off quickly when electricity is connected	<ul style="list-style-type: none"><li>- Charger coil is shorted</li><li>- Rectifier tube is broken</li></ul>	<ul style="list-style-type: none"><li>- Check the value of resistance</li><li>- Replace or repair</li></ul>



**CAUTION: CALL CUSTOMER SERVICE AT 1-800-493-1646 OR CONSULT A PROFESSIONAL BICYCLE MECHANIC WITH ANY QUESTIONS ON REPAIRS OR MAINTENANCE.**



# ELECTRIC BIKE FAQs

## **Q. How long does it take to fully charge the battery?**

A. Depends on the state of discharge but around 5-6 hours if completely discharged.

## **Q. What are the running costs for an electric bike?**

A. You will have no worries about rising fuel prices at the pumps. All our electrically powered vehicles use household electricity. The average cost per full charge is about 10 cents per charge. If you charge the battery every single day for a year, it would cost you about \$35 per year.

## **Q. Can I ride up hills and against strong headwinds on my electric bike?**

A. Yes. One of the main advantages of cycling on an electric bicycle is that it literally flattens hills and increases your average speed when tackling inclines and headwinds. If you provide a reasonable amount of effort, you should be able to tackle anything from a 1 in 10 (10%) gradient up to a 1 in 7 (14%) gradient. You will be amazed at the relative ease that your new electric bike can tackle some of the most arduous journeys.

## **Q. Do I need a driver's license, insurance or registration?**

A. No, you don't. According to Federal law, electric bikes that are under 750 watts are classified as bicycles. For all intents and purposes, it's simply a bicycle that requires very little pedaling to travel 20 MPH (32 Km/H), saving you time and hassle. The law does require the use of helmet and riders to be at least 16 years old. Check your local state laws for requirements. It is required that the owner/user follow all applicable traffic rules and regulations.

## **Q. Do I need to pedal an electric bike?**

A. No, but it helps to prolong battery life. The motor on our bikes is both throttle and pedal assist controlled, allowing you to decide how much power you desire. Have you ever tried to cycle when speeding downhill on your normal bicycle? It's just like that. The motor is propelling you faster than you're cycling so there is pretty much no resistance, it's merely a formality!

## **Q. What happens when I use the brakes under powered assistance?**

A. All our bikes are equipped with brake levers that have a built-in safety switch that automatically cuts off the motor power under normal braking conditions. This not only ensures a safe non-powered stopping feature, but also protects the motor under braking conditions so that it isn't working against the brakes.

# ELECTRIC BIKE FAQs

## **Q. How far will an electric bike take me?**

A. This all depends on a few factors. Cycling with pedal assist along a straight road under normal conditions, the standard battery should last about 15-30 miles (24 - 48 kilometers). Cycling up steep hills will obviously take more energy out of the battery and factors such as road surface, wind resistance, weight of the rider and tire pressure will affect your range. Longer range battery is also available.

## **Q. What happens if I get a flat tire?**

A. The tires on our bikes are the same as conventional bicycles. Simply replace the tube with a tube of the right size and inflate it. No special tires or parts will be needed.

## **Q. How do I know when the battery is low?**

A. The bicycles have easily visible indicators located on the meters that show the amount of power remaining. If it is getting low and you don't think you will make it to your destination, you can switch off your motor and keep it just for the difficult bits while still pedalling manually.

## **Q. Do I have to wait for the battery to empty before I charge it?**

A. No. The batteries we use are Lithium-ion batteries which do not suffer from 'memory effect'. This means that there is no need to discharge a battery completely before you recharge it again. You can partially recharge the battery at any time without reducing its voltage or lifespan. We recommend recharging the battery after every use, regardless of how far you rode.

## **Q. Can I put a child's trailer on an electric bike?**

A. Yes. We suggest using one that hooks onto the frame rather than the axle.

**NOTE:** Be careful when pulling a trailer as weight increases and balance may cause changes.

## **Q. Can I put an electric bike on a bike rack?**

A. Yes, just make sure that the bike rack can hold the weight of your bike.

# LIMITED WARRANTY

This Limited Warranty extends only to the original retail purchaser, who must produce proof of purchase in order to validate any claim. This warranty is not transferable to anyone else.

## **What does this Limited Warranty cover?**

This warranty covers all parts of the bicycle to be free of defects in workmanship and materials. It does not cover abuse, misuse, or alterations.

## **What must you do to keep the Limited Warranty in effect?**

This warranty is effective only if:

- The bicycle is completely and correctly assembled and maintained.
- The bicycle is used under normal conditions for its intended purpose, by a person that properly fits and is capable of controlling the bicycle.
- The bicycle receives all necessary service maintenance and adjustments.

## **What is not covered by this Limited Warranty?**

This warranty does not include labor and transportation charges. The bicycle is designed for general transportation and recreational use only. This warranty does not cover normal wear and tear, paint, rust, normal maintenance items, personal injury, or any damage, failure, or loss that is caused by accident, improper assembly, maintenance, adjustment, storage, or use of the bicycle.

## **This Limited Warranty will be VOID if the bicycle is ever:**

- Used in any competitive sport.
- Used for stunt riding, jumping, aerobatics or similar activity.
- Installed with a non-standard motor or modified in any other way.
- Ridden by more than one person at a time.
- Rented or used for commercial purposes.
- Used in a manner contrary to the instructions in this Owner's Manual. Joy Ride Bike will not be liable for incidental or consequential loss or damage, due directly or indirectly from use of this product.

# LIMITED WARRANTY

## **For how long does this Limited Warranty last?**

The frame is warranted for the usable life of the bicycle. Joy Ride Bike will replace the frame at no charge, should it fail in any weld point when the cycle has been used in a normal manner, and determined by our inspection Joy Ride Bike will also replace the bicycle fork if it should fail at any weld point.

You must receive prior authorization from Joy Ride Bike Customer Service, before returning any product or parts. The battery is warranted for one year. All other components are warranted against defects for six months from the date of purchase when properly assembled and used in a normal manner.

## **What will Joy Ride Bike do?**

We will replace, without charge to you, any frame, fork, or component found to be defective by Joy Ride Bike. CONSUMER MUST PAY ALL LABOR AND TRANSPORTATION CHARGES CONNECTED WITH THE REPAIR OR WARRANTY WORK.

## **How do you get service?**

Call the Customer Service Department (8am-4pm E.S.T.) at 1-800-493-1646.

All warranty claims should be made to:

Joy Ride Bike

Go to our website [www.JoyRideBike.com](http://www.JoyRideBike.com)

Or call toll free

1-800-493-1646

## **What rights do you have?**

This limited warranty gives you specific legal rights. You may also have other rights which vary from State to State.



**NOTE: BEFORE TRANSPORTING THE BIKE AND/OR BATTERY,  
CALL CUSTOMER SERVICE AT 1-800-493-1646 FOR  
SPECIFIC DETAILED INSTRUCTIONS.**

# IMPORTANT INFORMATION

1. The battery's performance can be effected by its environment. Generally speaking, battery's discharge performance is better in a higher temperature. Electric power will drop by more than 1/3 when the temperature is below 32°F (0°C). Thus, the e-bike's riding distance per charge will become shorter in winter or cold areas. It returns to normal or optimal distance per charge when the temperature is higher than 68°F (20°C).
2. Do not put any metal objects in charge hole or battery circuit, it may cause short circuit or start a fire.
3. Do not dismantle or change any parts without authorization of the manufacturer. Any loss caused by inappropriate use, misuse or dismantling can cause dangers to the rider where manufacturer cannot be liable. Be reminded e-bikes warranty can be affected, too. In general, if you think there might be any problem with your e-bike, please contact customer service at 1-800-493-1646.
3. Speeding especially on downhill roads can be dangerous. Slamming brakes at high speed might cause the bike to skid and lead to a road accident. Do not use the front brake to hard, it can cause you to fall forward over the handlebars and can severely hurt you.
4. Oil in the brake pad's or rim's surface can or will put brakes out of order. This can cause danger and accident. Beware of this.
5. Do not hang anything on the handlebar while riding. Verify the monitor display and any accessories are securely attached to avoid failure or loss during operation.
6. This e-bike is fit to be ridden by one person only, do not carry a passenger.
7. To protect your battery and avoid danger, do not connect battery's positive and negative side with one another or any conductor.
8. Adjust the brake caliper position each month, change the brake pad each half year or one year to keep the brake function in good condition.
9. The front wheel is fixed with the fork by quick-release lever. Make sure the handle can be pressed tight. If not tight, unscrew the nut then press it again until the handle is tight after lock. Please regularly check the rims of bike, especially for the caliper brake, that avoid the regularly using brakes causing the rim edge thinning and affect the strength of the rim, resulting the tires blowout and result the user's injury.
10. Do not ride while intoxicated. Do not ride when taking medicine or when you are not feeling well.



**CAUTION: CALL CUSTOMER SERVICE AT 1-800-493-1646 OR  
CONSULT A PROFESSIONAL BICYCLE MECHANIC WITH ANY  
QUESTIONS ON REPAIRS OR MAINTENANCE.**







**Joy****Ride**  
BIKES®