

WARHAMMER 40,000 KILL TEAM

NEOPHYTE HYBRIDS

STEPS • ÉTAPES • PASOS
SCHRITTE • FASI **1 - 16**



• CHOOSE THE VARIANT YOU WANT TO BUILD • CHOISISSEZ LA VARIANTE À ASSEMBLER
• ELIGE QUÉ VERSIÓN QUIERES MONTAR • WÄHLE DIE VARIANTE, DIE DU BAUEN MÖCHTEST
• SCEGLI LA VARIANTE CHE VUOI ASSEMBLARE

SKITARI RANGERS

STEPS • ÉTAPES • PASOS
SCHRITTE • FASI **17 - 26**



SKITARI VANGUARD

STEPS • ÉTAPES • PASOS
SCHRITTE • FASI **27 - 37**



SECTOR IMPERIALIS

STEPS • ÉTAPES • PASOS
SCHRITTE • FASI **38 - 44**



STARTER SET

CITADEL®

© Copyright 2018, Games Workshop Ltd. All rights reserved.

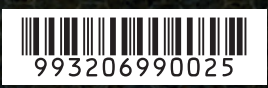



• **READ THIS FIRST** • **À LIRE EN PREMIER** • **LEER ANTES DE MONTAR**
 • **LIES DIES ZUERST** • **LEGGI PRIMA QUESTO**

• **BEFORE ASSEMBLING YOUR MINIATURES PLEASE READ THROUGH THE INSTRUCTIONS IN THIS BOOKLET CAREFULLY.**

A pair of plastic cutters is required to remove the plastic components in this kit from their frame. We advise using a mouldline scraping tool to clean up the parts. To assemble your model you will need plastic glue. Games Workshop sells Citadel Fine Detail Cutters, Citadel Mouldline Remover and Citadel Plastic Glue, but does not recommend these products for use by children under the age of 16 without adult supervision.

• **AVANT D'ASSEMBLER VOS FIGURINES, VEUILLEZ LIRE ATTENTIVEMENT LES INSTRUCTIONS DE CE LIVRET.**

Une pince coupante est requise pour détacher chaque élément de sa grappe. Nous vous recommandons l'utilisation d'un grattoir pour ébarber les éléments. Pour l'assemblage, vous aurez également besoin de colle plastique. Games Workshop commercialise les Pinces de Précision Citadel, l'Ébarboir Citadel et la Colle Plastique Citadel, mais n'en recommande pas l'utilisation pour des enfants de moins de 16 ans sans la supervision d'un adulte.

• **POR FAVOR, LEE CUIDADOSAMENTE ESTE LIBRETO DE INSTRUCCIONES ANTES DE EMPEZAR A MONTAR LAS MINIATURAS.**

Te harán falta unas tenazas para plástico a fin de separar las piezas de la matriz. También aconsejamos una herramienta para rebabas a fin de limpiar cada pieza. Para montar la miniatura necesitarás pegamento para plástico. Games Workshop vende Tenazas Citadel, Herramientas para rebabas Citadel y Pegamento para plástico Citadel, pero no recomienda estos productos a menores de 16 años sin la supervisión de un adulto.

• **VOR DEM ZUSAMMENBAU DER MINIATUREN BITTE DIE ANWEISUNGEN IN DIESER ANLEITUNG AUFMERKSAM DURCHLESEN.**

Du benötigst einen Kunststoffseitenschneider, um die Kunststoffbauteile aus dem Gussrahmen herauszutrennen, und Kunststoffkleber, um die Miniatur zusammenzubauen. Außerdem empfehlen wir, die Bauteile vorher mit einem Gussgratentferner zu säubern. Games Workshop bietet Präzisions-Kunststoffseitenschneider von Citadel sowie Citadel-Kunststoffkleber an, empfiehlt aber, dass Kinder unter 16 Jahren diese nur unter Aufsicht eines Erwachsenen benutzen.

• **PRIMA DI ASSEMBLARE LE TUE MINIATURE LEGGI ATTENTAMENTE TUTTE LE ISTRUZIONI DI QUESTO LIBRETTO.**

Sono necessarie un paio di tronchesine per plastica per staccare i componenti dai loro sprue. Consigliamo di usare un attrezzo apposito per pulire i componenti. Per assemblare il modello avrai bisogno di colla per plastica. Games Workshop vende Tronchesine di precisione Citadel, Attrezzo per ripulire Citadel e Colla per plastica Citadel, ma non consiglia questi prodotti ad un pubblico minore di 16 anni senza la supervisione di un adulto.

• **EXPLANATION OF SYMBOLS** • **EXPLICATION DES SYMBOLES** • **EXPLICACIÓN DE SÍMBOLOS**
 • **ERLÄUTERUNG DER SYMBOLE** • **LEGENDA DEI SIMBOLI**



- Special instruction - Please read
- Instructions spéciales - Lire attentivement
- Instrucción especial: Por favor, léela
- Besondere Anweisung - Bitte lesen
- Istruzioni speciali - Leggi attentamente



- Choice of parts
- Choix d'éléments
- Modelos de componentes
- Auswahl an Teilen
- Scelta di componenti



- Repeat process
- Répéter l'étape
- Repetir pasos
- Vorgang wiederholen
- Ripeti il processo



- Dry fit stage before gluing
- Tester avant de coller
- Comprobar el encaje antes de pegar
- Positionierung erst ohne Klebstoff ausprobieren
- Prova a secco prima di incollare



- Variant assembly
- Variante d'assemblage
- Variante de montaje
- Bauvariante
- Assemblaggio alternativo



- Stage complete
- Étape terminée
- Paso completado
- Schritt abgeschlossen
- Fase completa



- Paint before assembly
- Peindre avant assemblage
- Pintar antes del montaje
- Erst bemalen, dann zusammenbauen
- Dipingi prima dell'assemblaggio



- Do not glue the components
- Ne pas coller les éléments
- No pegar los componentes
- Bitte die Teile nicht kleben
- Non incollare i componenti

16+



- Citadel plastic glue
- Colle plastique Citadel
- Pegamento para plástico
- Citadel-Kunststoffkleber
- Colla per plastica Citadel



- Citadel fine detail cutters
- Pinces de précision Citadel
- Tenazas Citadel
- Citadel-Seitenschneider
- Tronchesine di precisione Citadel

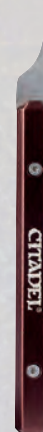

- Citadel mouldline remover
- Ébarboir Citadel
- Herramienta para rebabas Citadel
- Gussgratentferner
- Attrezzo per ripulire Citadel

1 NEOPHYTE LEADER

1 a

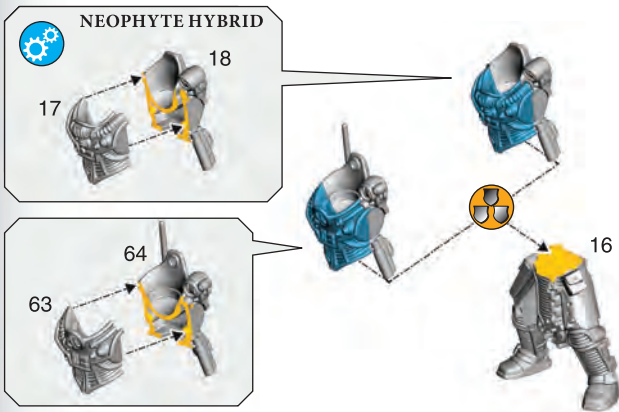

1 b

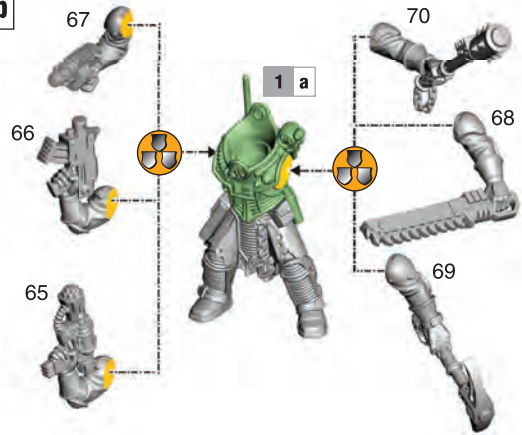

1 c

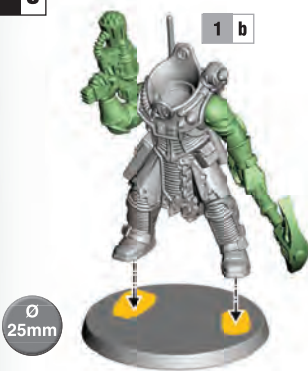

1 d



2 NEOPHYTE WITH CULT ICON

2 a

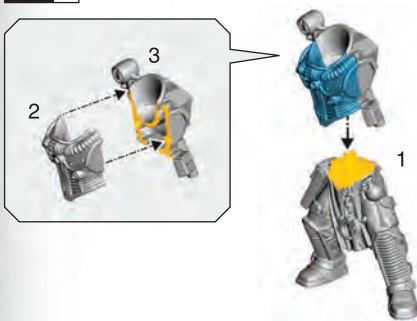

2 b



2 c

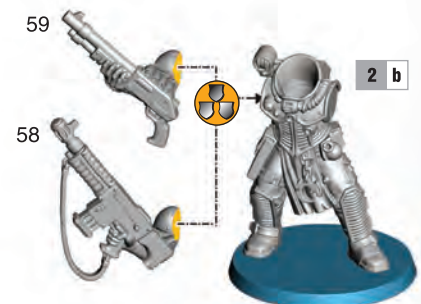

2 d



2 e





- CHOOSE THE VARIANT YOU WANT TO BUILD
- CHOISISSEZ LA VARIANTE À ASSEMBLER
- ELIGE QUÉ VERSIÓN QUIERES MONTAR
- WÄHLE DIE VARIANTE, DIE DU BAUEN MÖCHTEST
- SCEGLI LA VARIANTE CHE VUOI ASSEMBLARE



NEOPHYTE WITH MINING LASER



NEOPHYTE WITH SEISMIC CANNON



NEOPHYTE WITH HEAVY STUBBER

3 a

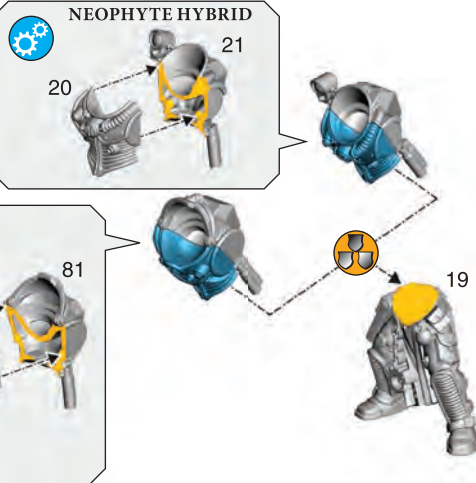

3 b

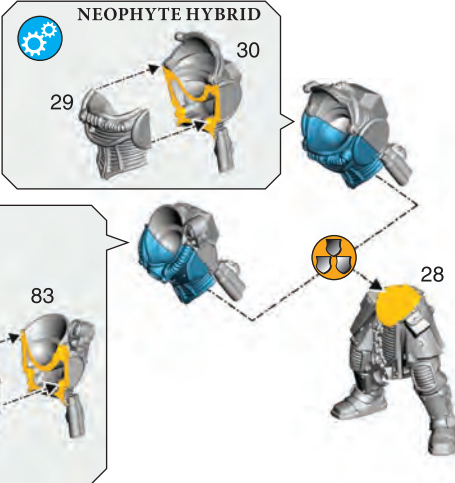

4 NEOPHYTE WITH MINING LASER

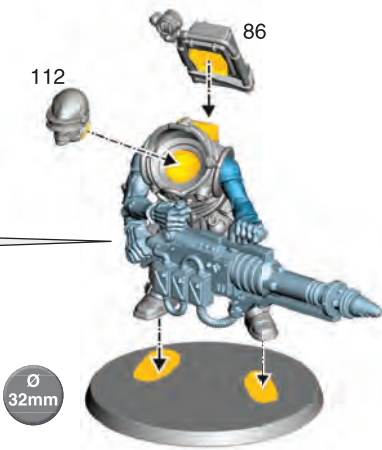
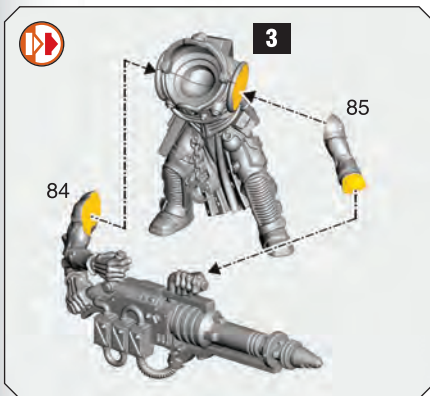

5 a NEOPHYTE WITH SEISMIC CANNON

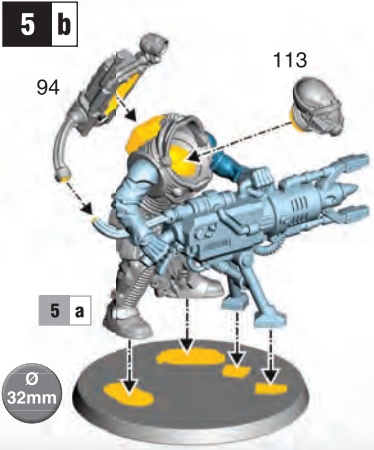
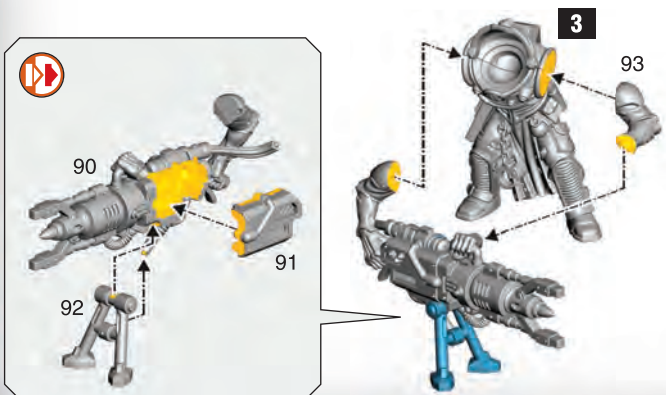

6 NEOPHYTE WITH HEAVY STUBBER

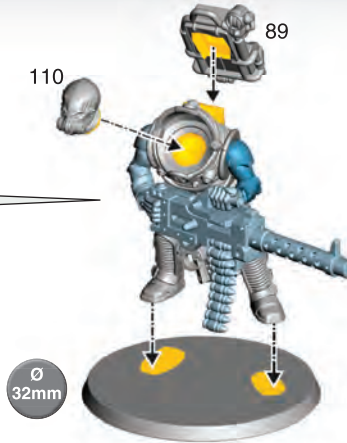
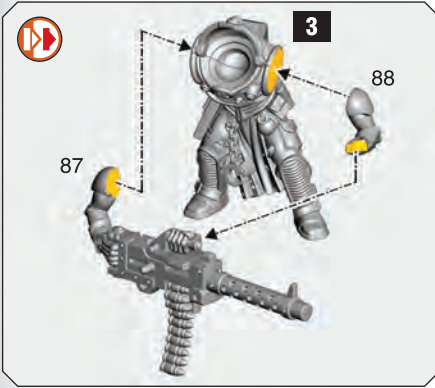

7 - 10 NEOPHYTE WITH SPECIAL WEAPONS



- CHOOSE THE VARIANT YOU WANT TO BUILD
- CHOISISSEZ LA VARIANTE À ASSEMBLER
- ELIGE QUÉ VERSIÓN QUIERES MONTAR
- WÄHLE DIE VARIANTE, DIE DU BAUEN MÖCHTEST
- SCEGLI LA VARIANTA CHE VUOI ASSEMBLARE



NEOPHYTE WITH FLAMER



NEOPHYTE WITH GRENADE LAUNCHER



NEOPHYTE WITH WEBBER

7 a

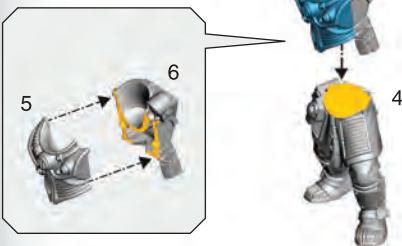

7 b

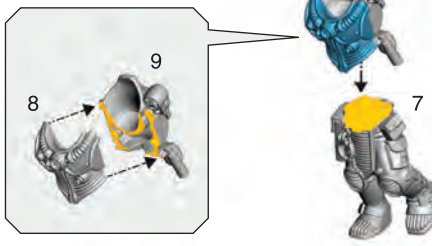

8 NEOPHYTE WITH GRENADE LAUNCHER

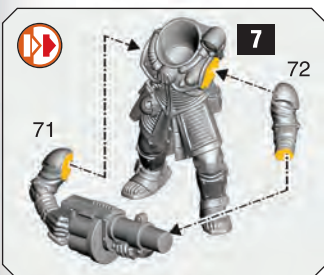

9 NEOPHYTE WITH FLAMER

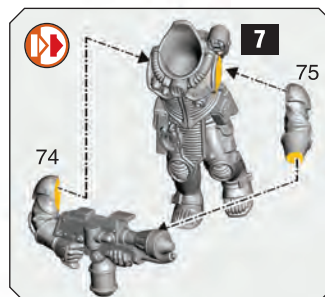

10 NEOPHYTE WITH WEBBER

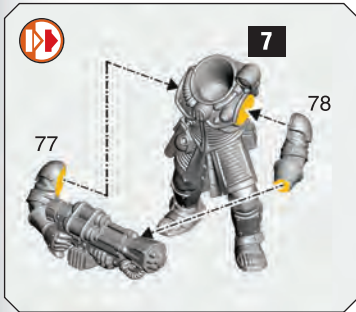

11 - 13 NEOPHYTES HYBRIDS 4TH GENERATION x2

11 • USE MATCHING PARTS • UTILISER LES ÉLÉMENTS CORRESPONDANTS • USA LAS PIEZAS QUE CORRESPONDAN • VERWENDE DIE PASSENDEN TEILE • USA LE PARTI CORRISPONDENTI

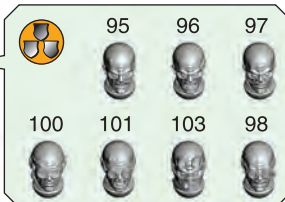
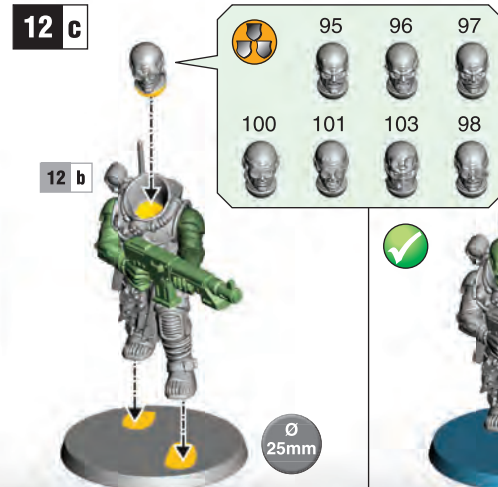
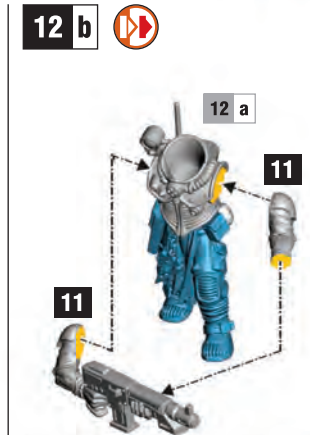
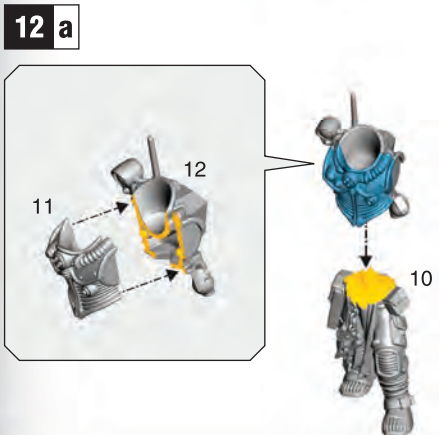
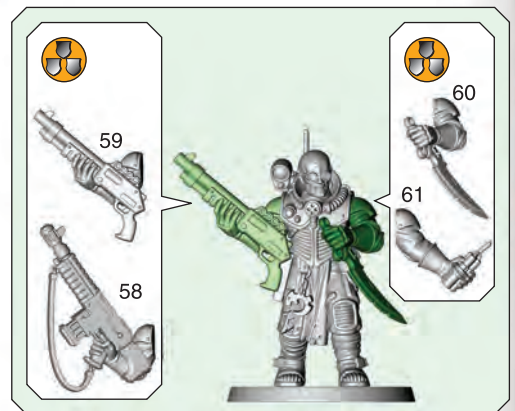
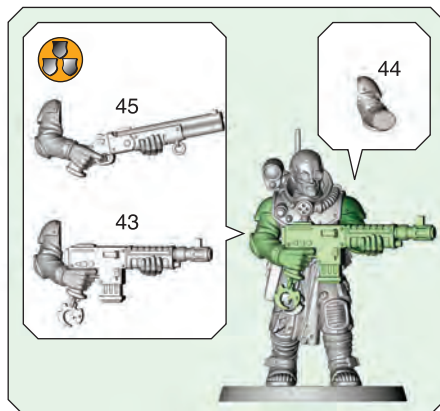
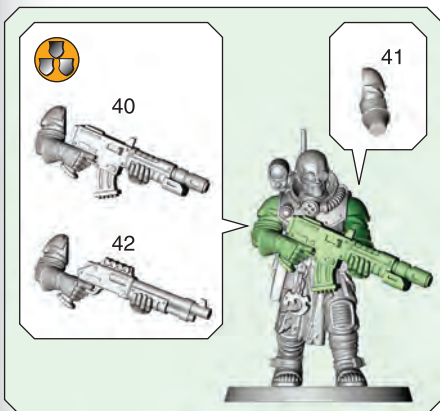
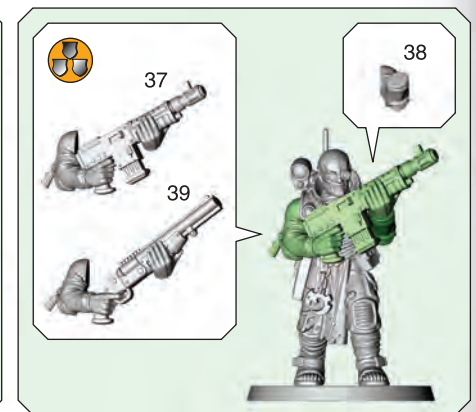
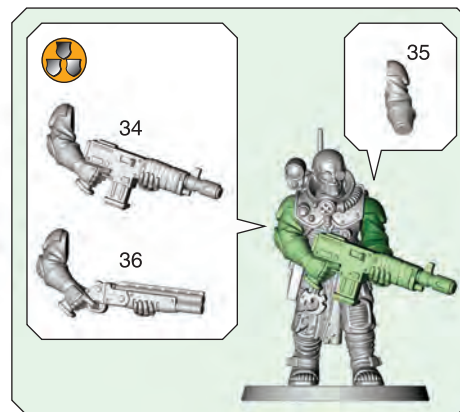
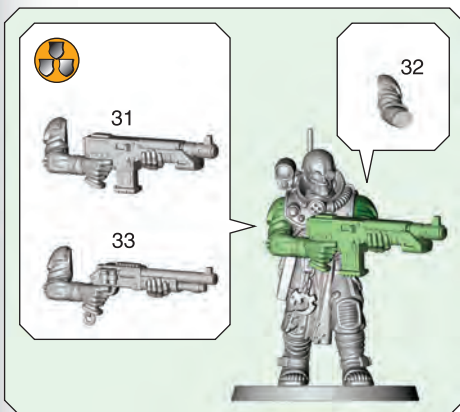

13 a

13 b

13 c

	96
	98
	95
	97
	100
	101
	103

14 - 16 NEOPHYTES HYBRIDS 3RD GENERATION x2

14 • USE MATCHING PARTS • UTILISER LES ÉLÉMENTS CORRESPONDANTS • USA LAS PIEZAS QUE CORRESPONDAN • VERWENDE DIE PASSENDEN TEILE • USA LE PARTI CORRISPONDENTI

15 a

15 b

15 c

	106	107
	108	109

16 a

16 b

16 c

	106	107
	108	109

17 SKITARII RANGER ALPHA

17 a

58

49

50

51

Ø 25mm

17 b

54

119

120

57

53

52

56

55

17 a



18 - 26 SKITARII RANGERS

18 a

72

59

60

61

Ø 25mm

18 b ENHANCED DATA-TETHER

107

73

67

71

18 a



18 c OMNISPEX

107

67

70

69

68

18 a

18 d GALVANIC RIFLE

107

64

65

18 a

19 a

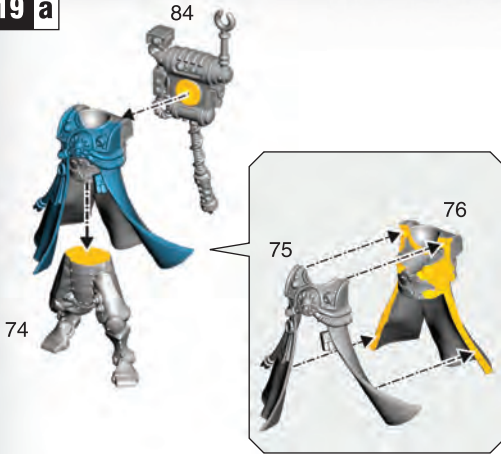

19 b GALVANIC RIFLE



19 c TRANSURANIC ARQUEBUS

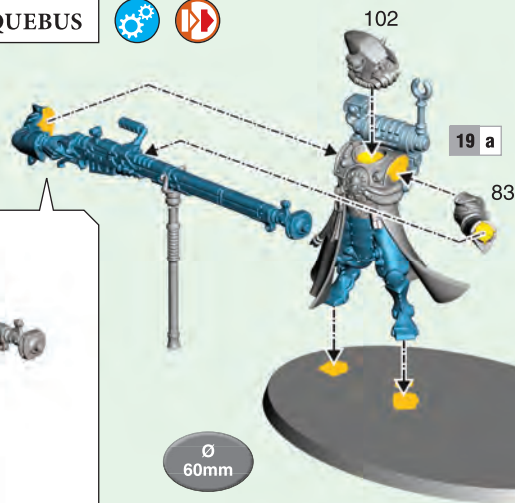

20



99



100



101



103



104



105



106



108



123



124



21 a

Ø 25mm

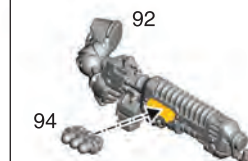
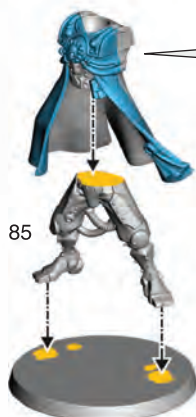

21 b PLASMA CALIVER

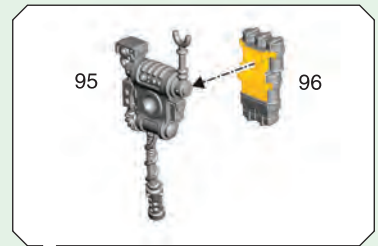
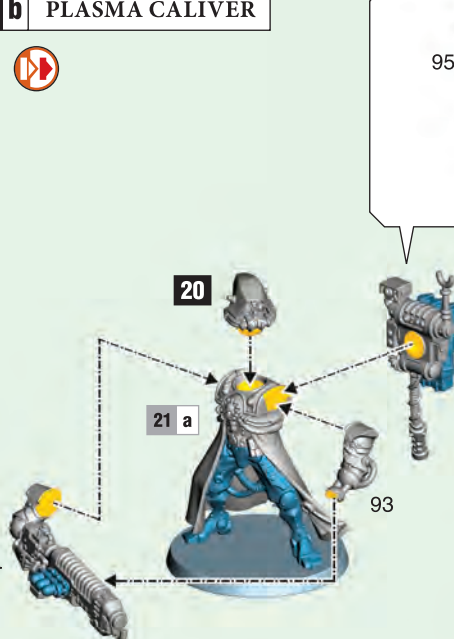

21 c ARC RIFLE

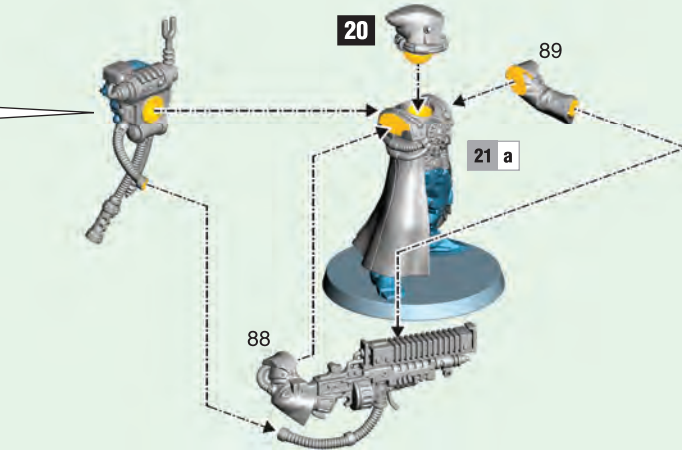
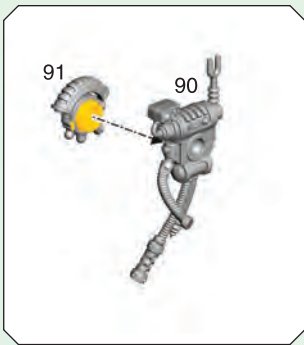

22 a

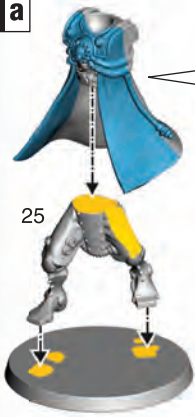

22 b GALVANIC RIFLE

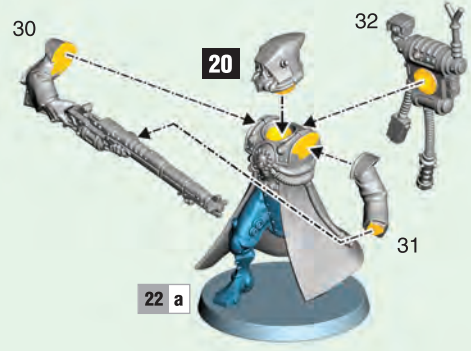

22 c ARC RIFLE

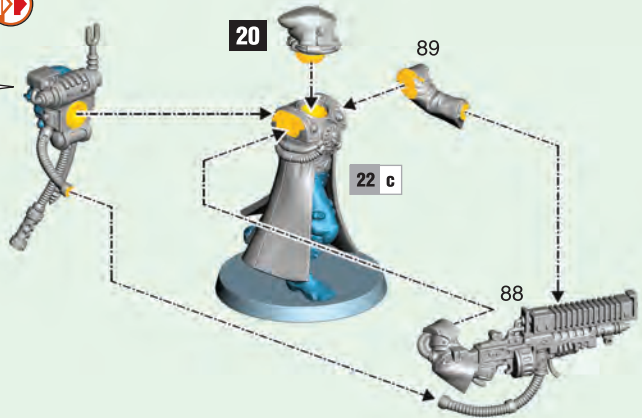
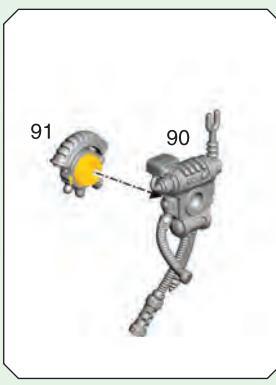

22 d PLASMA CALIVER

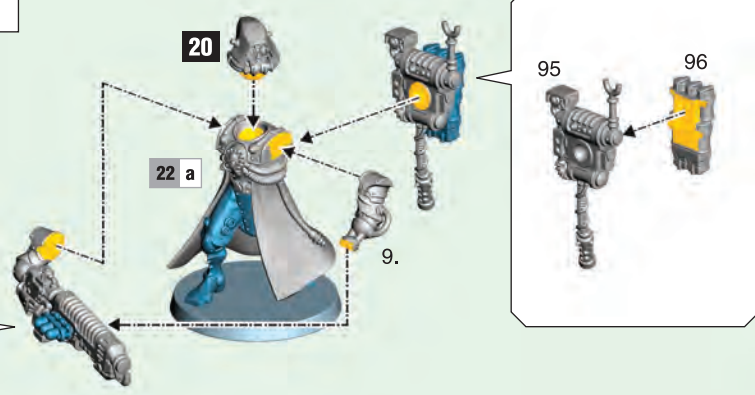
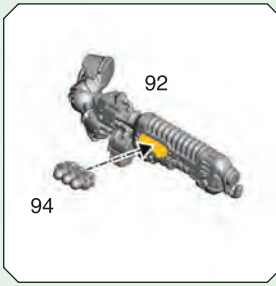

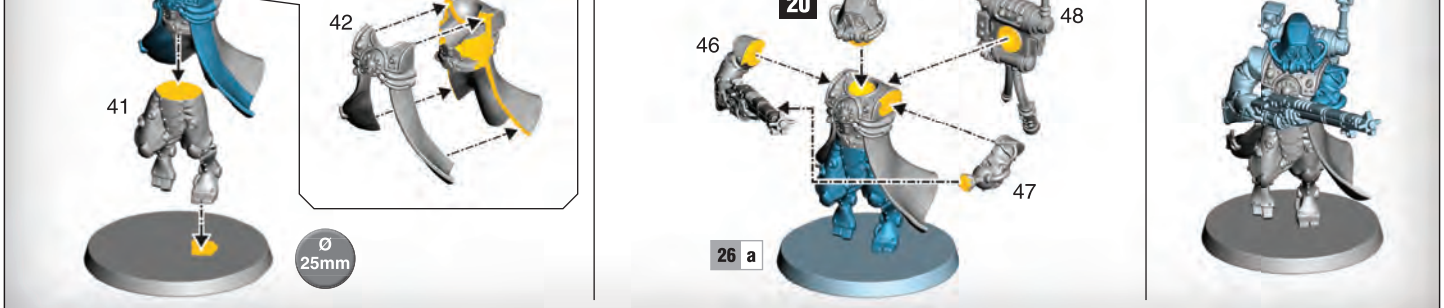
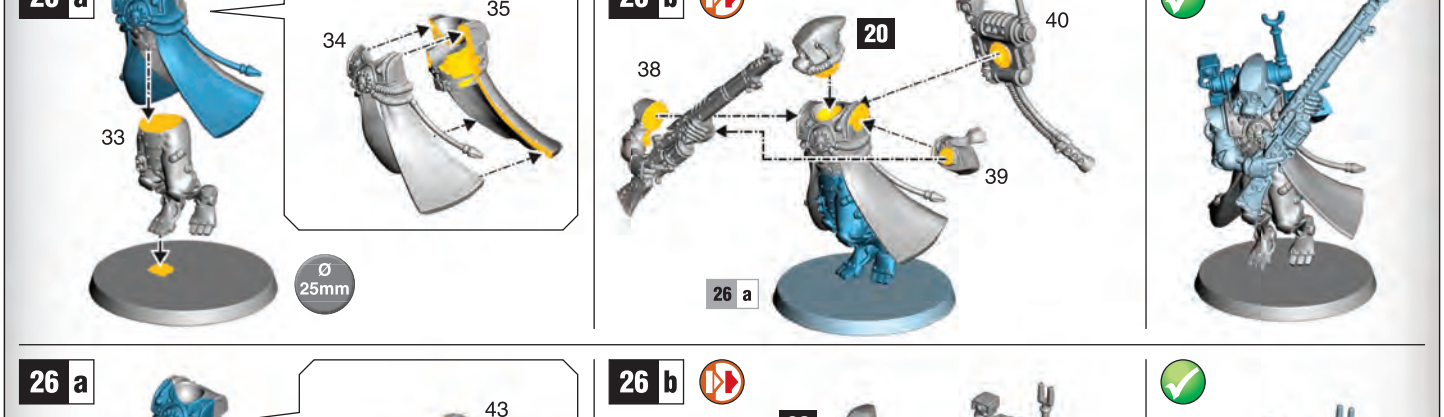
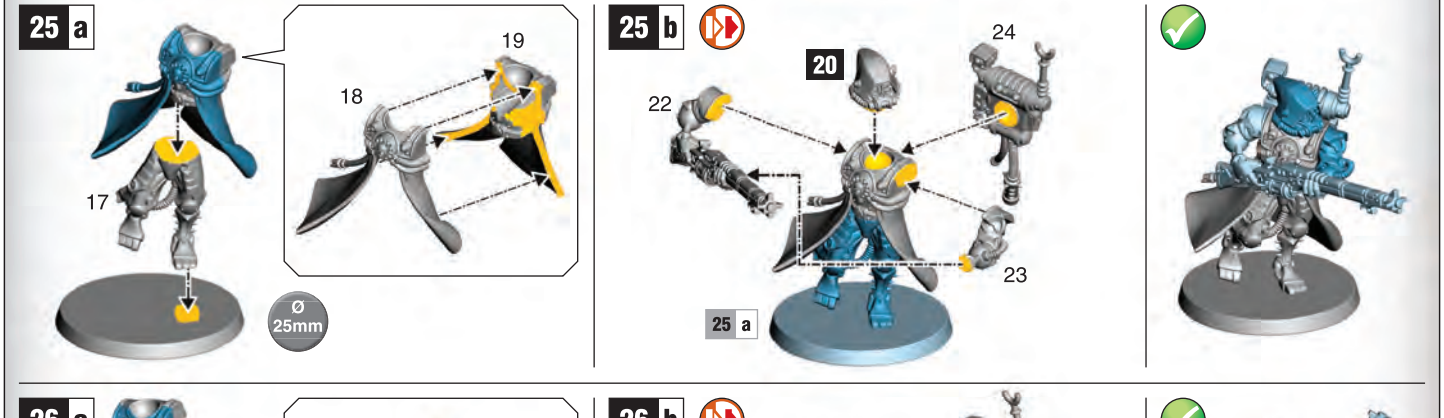
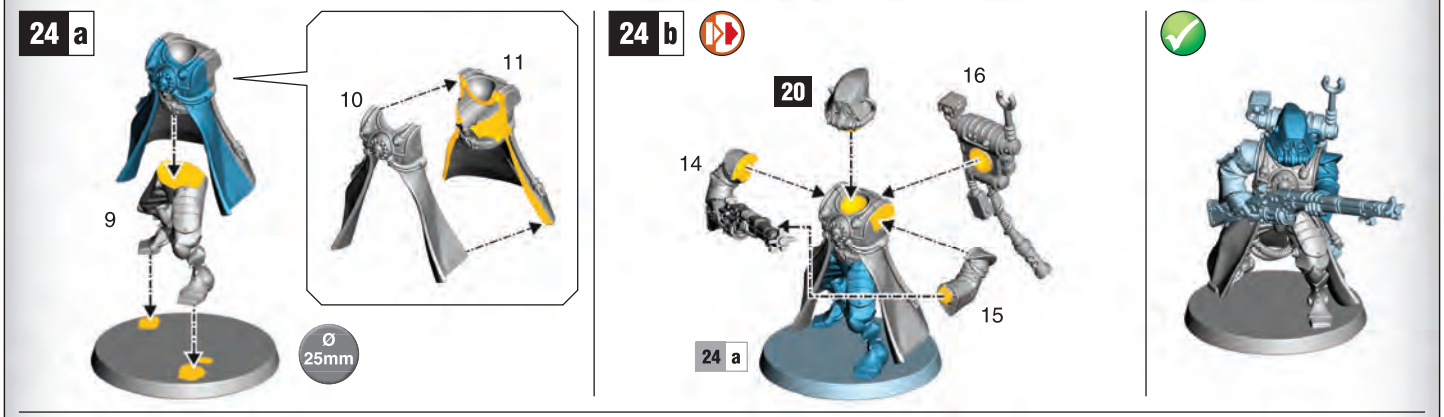
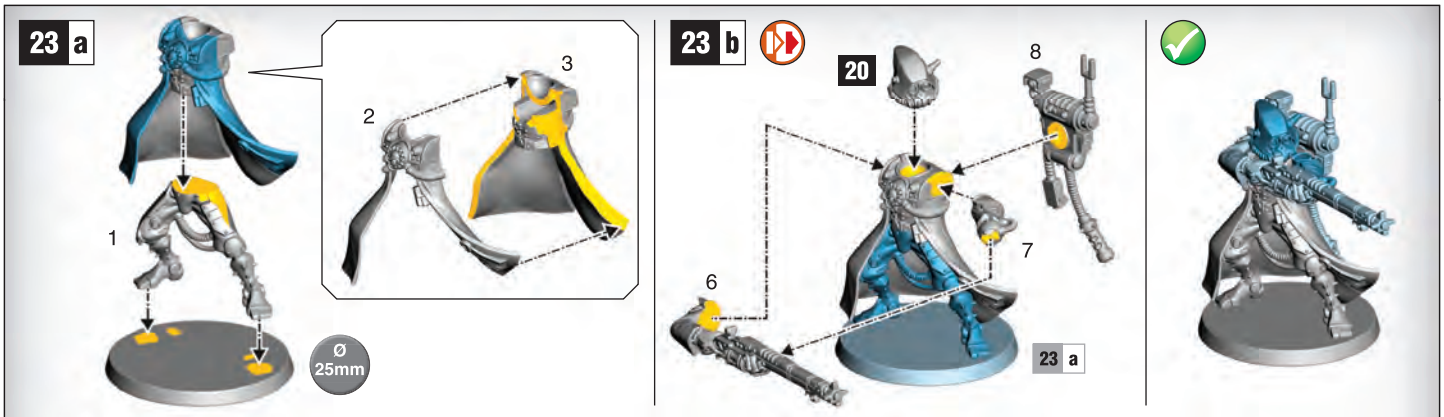

27 SKITARII VANGUARD ALPHA

27 a

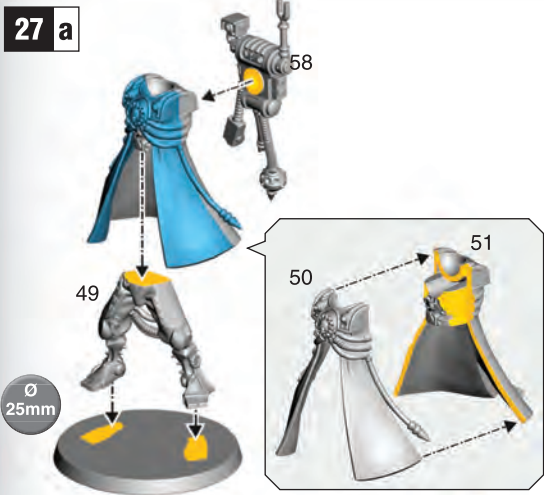

27 b

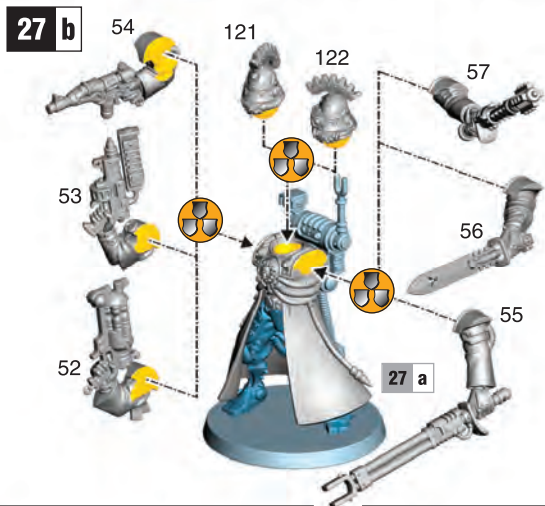

28 - 37 SKITARII VANGUARD

28 a

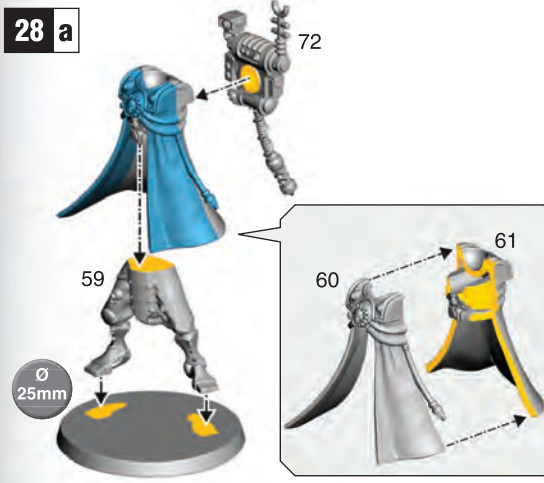

28 b

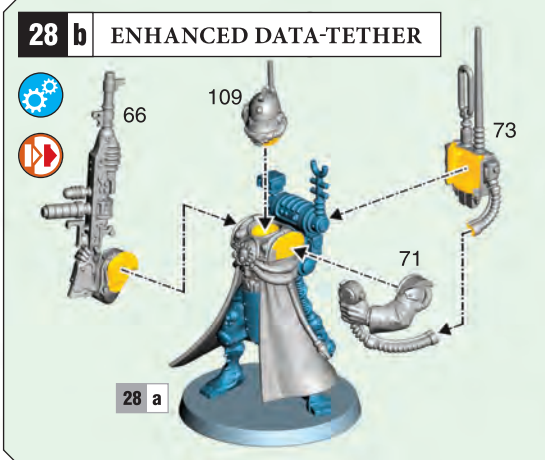

28 c

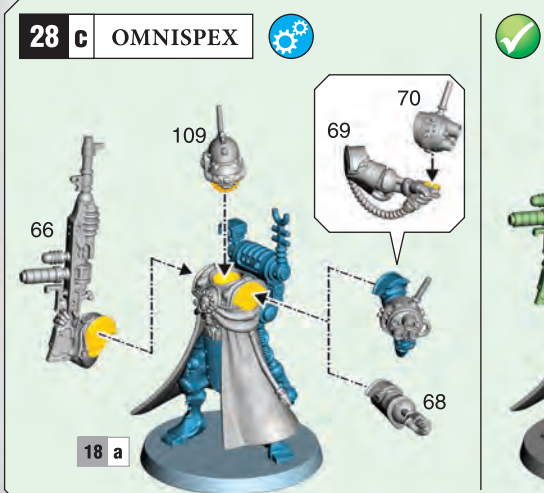

28 d

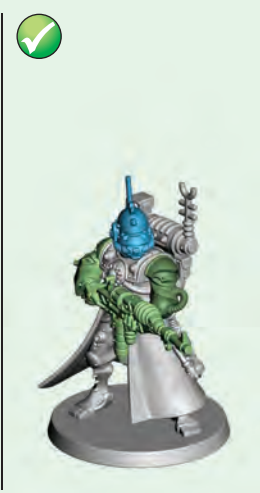

29 a



29 b GALVANIC RIFLE



29 c TRANSURANIC ARQUEBUS

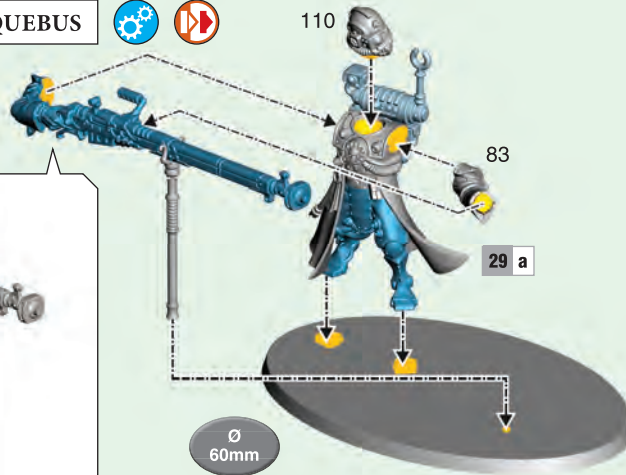
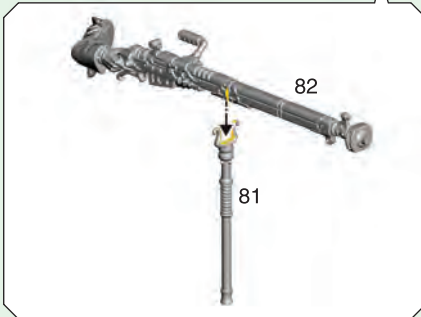

30 a



30 b ARC RIFLE

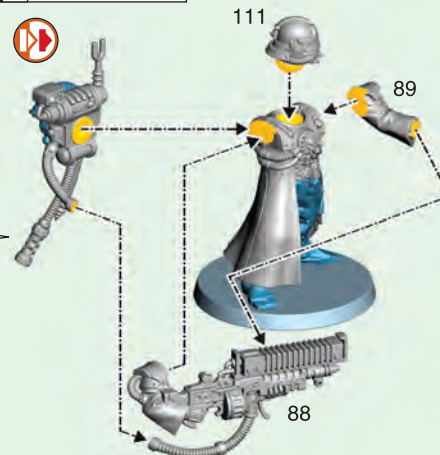

30 c PLASMA CALIVER

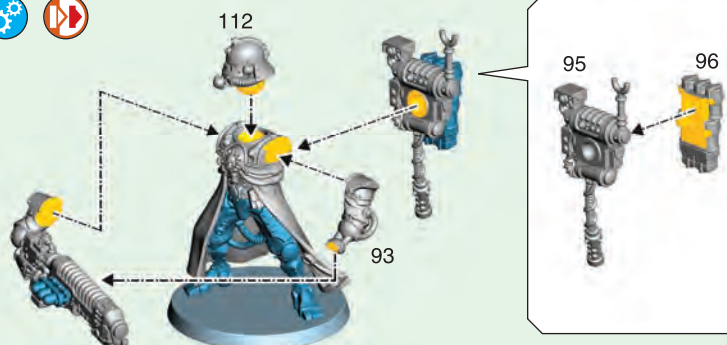
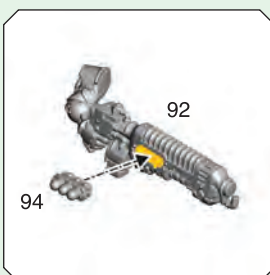

31

113

114

115

116

117

118

123

124



32 a



Ø 25mm

32 b

RADIUM CARBINE



32 c

ARC RIFLE

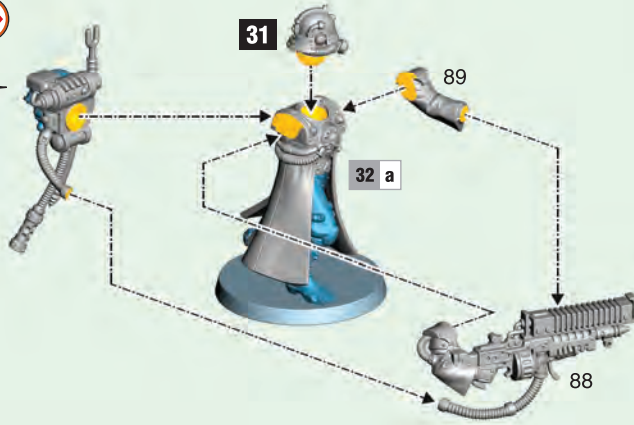
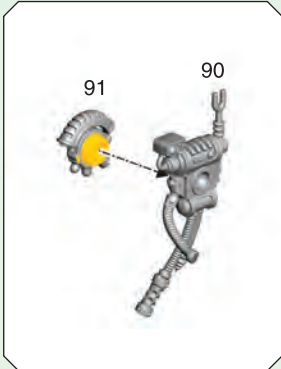

32 d

PLASMA CALIVER

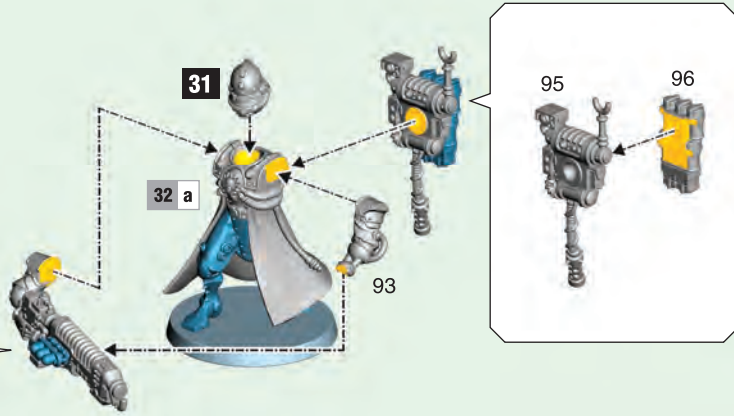
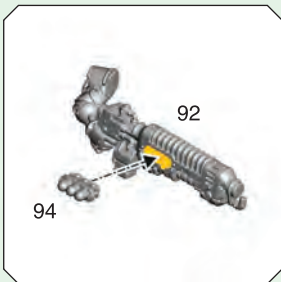

33 a

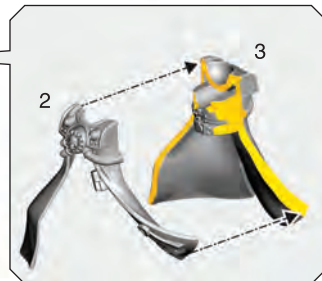

Ø 25mm

33 b



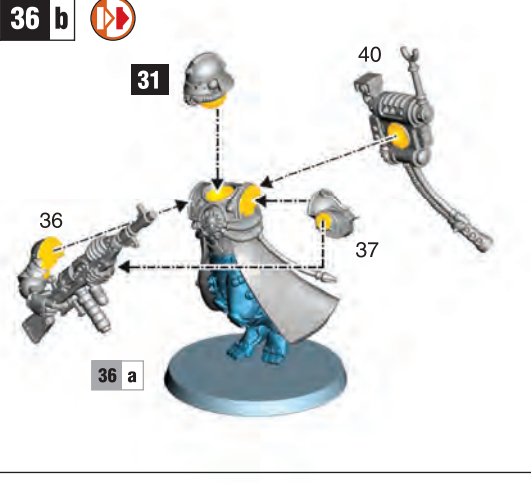
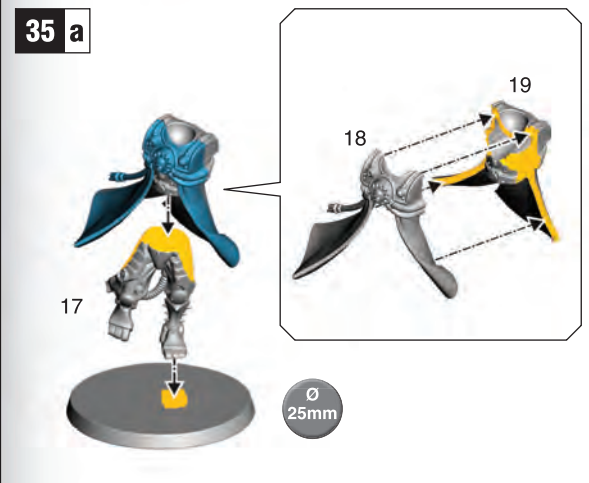

38 RUIN 1

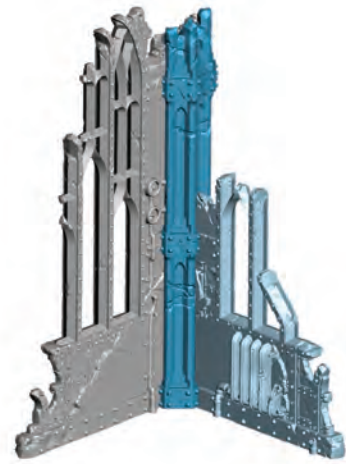
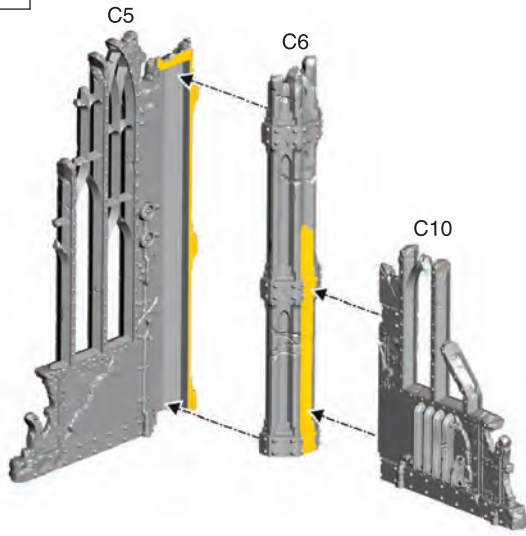

39 RUIN 2

x2

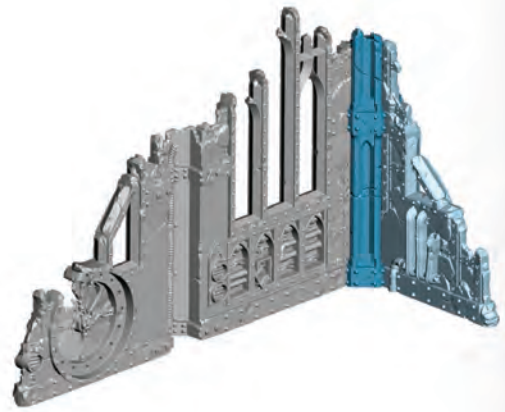
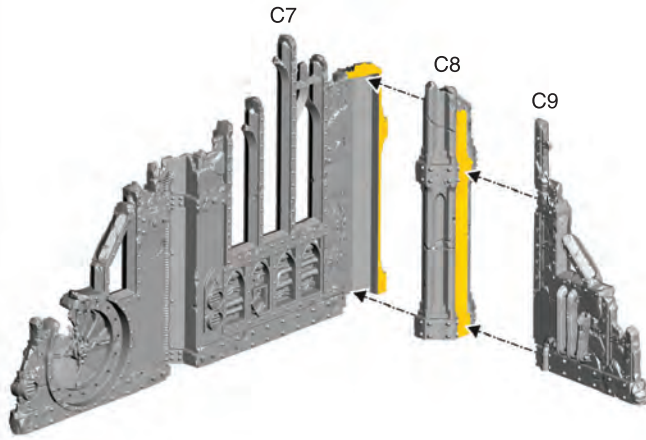

40 a RUIN 3

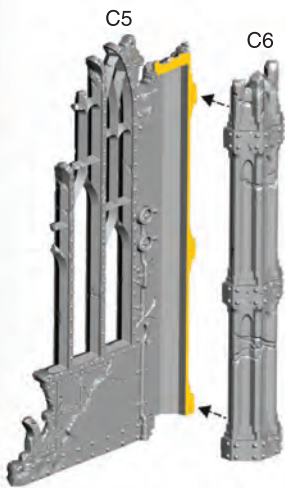

40 b

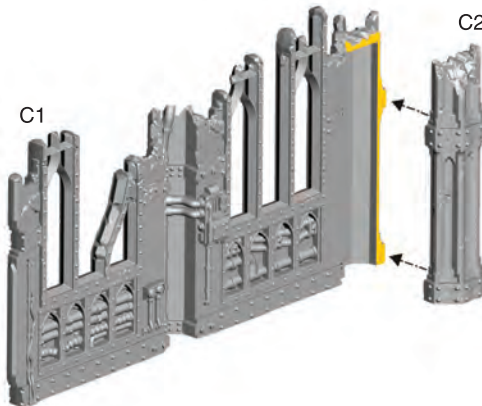

40 c

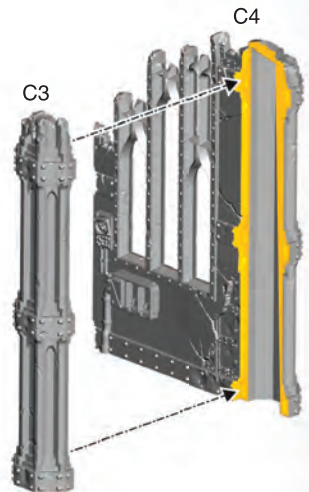

40 d

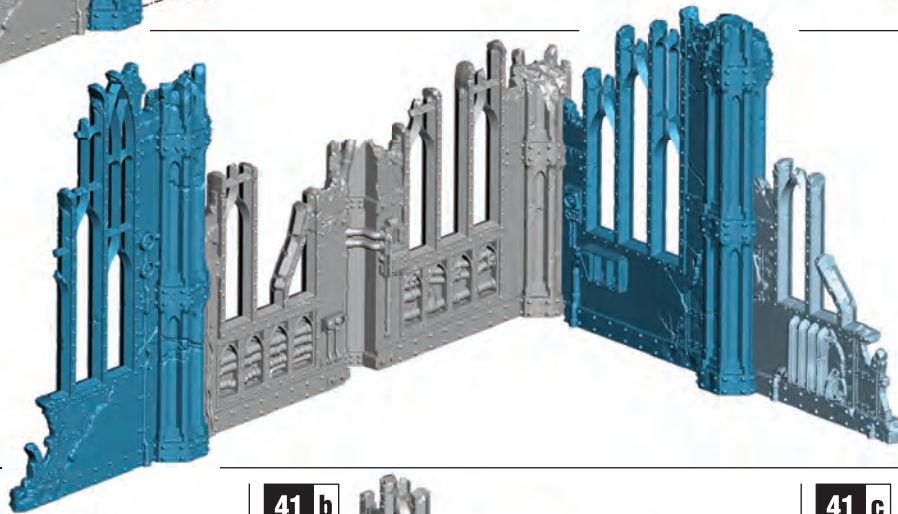
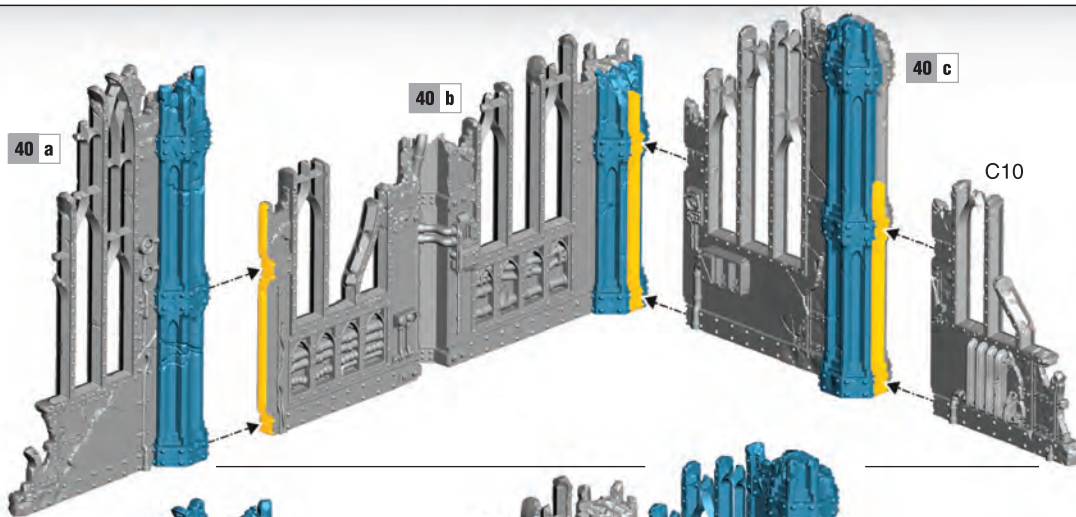

41 a RUIN 4

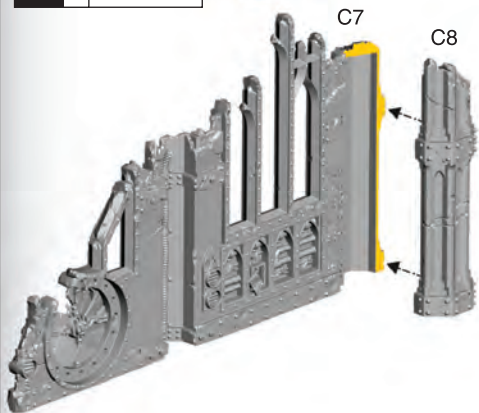

41 b

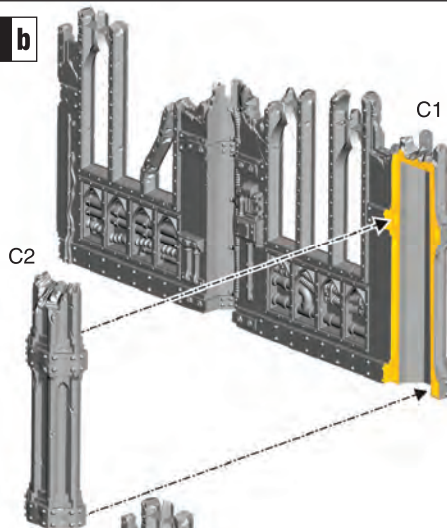

41 c

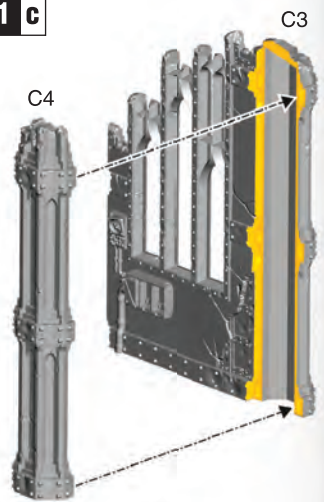

41 d

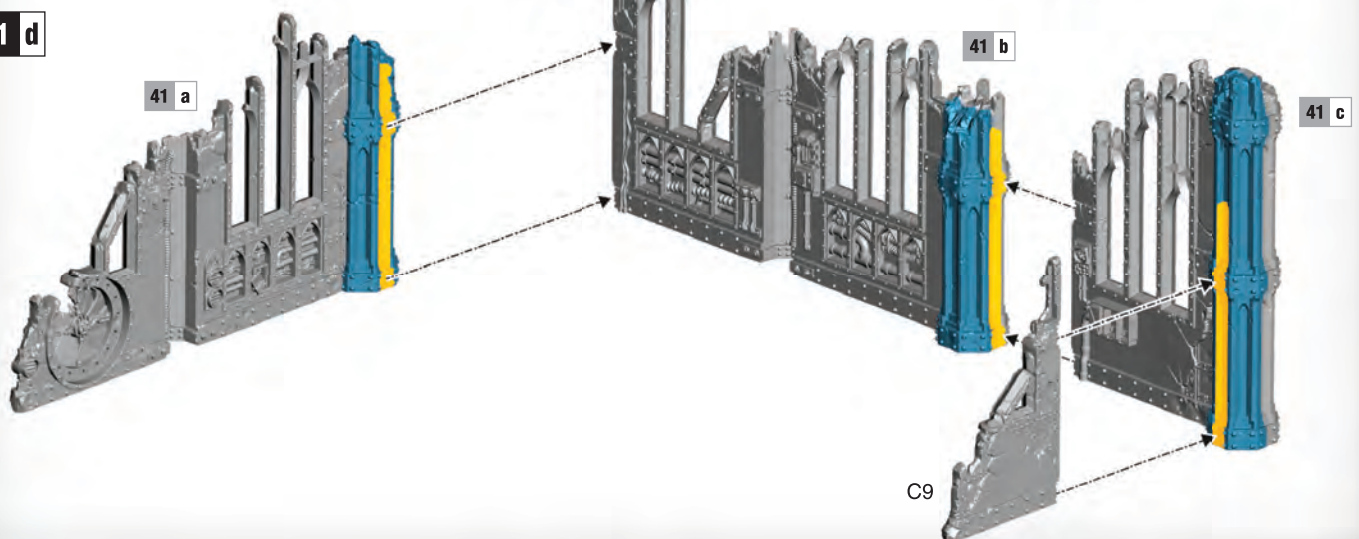

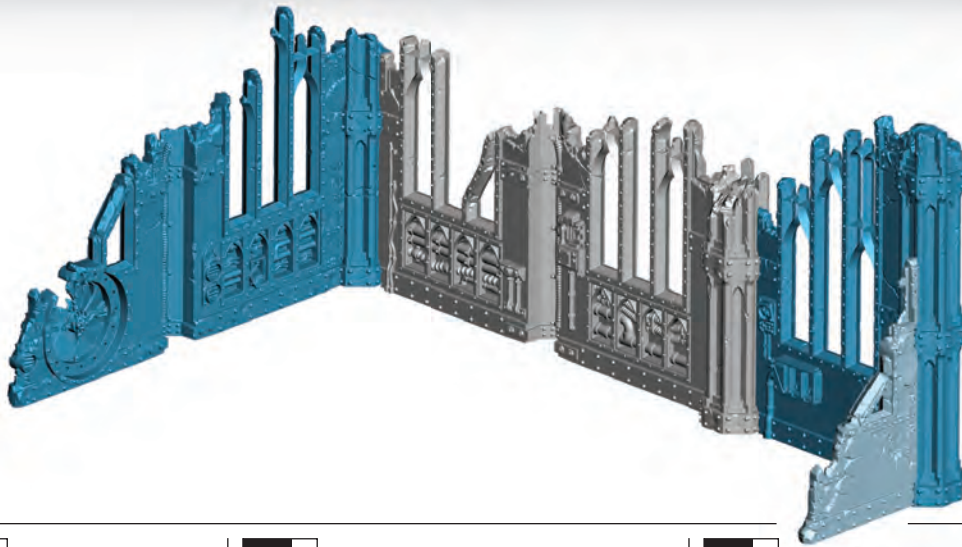

42 a RUIIN 5

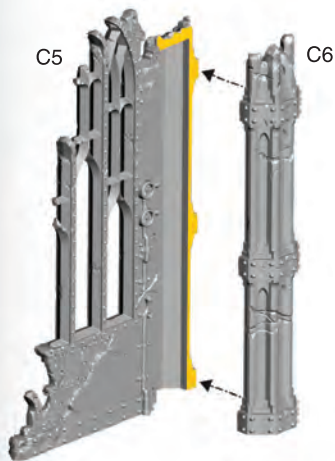

42 b



42 c

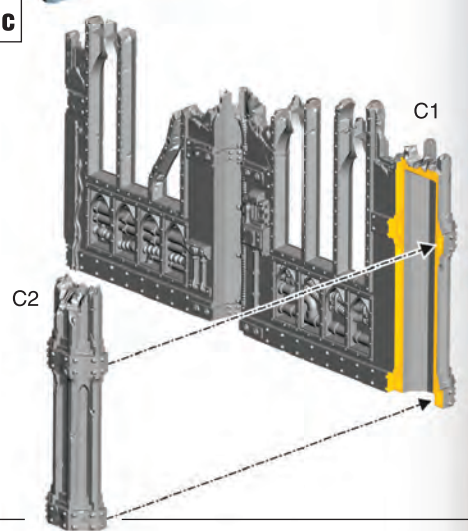

42 d

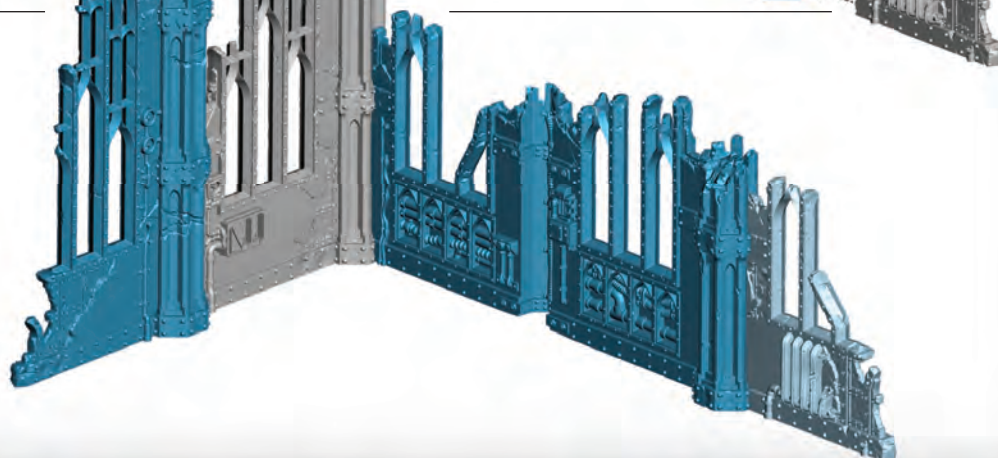
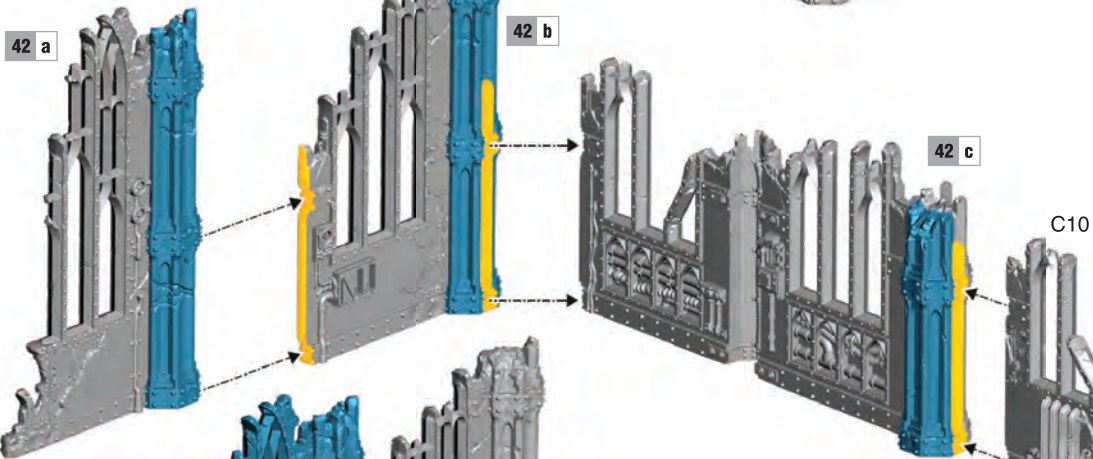

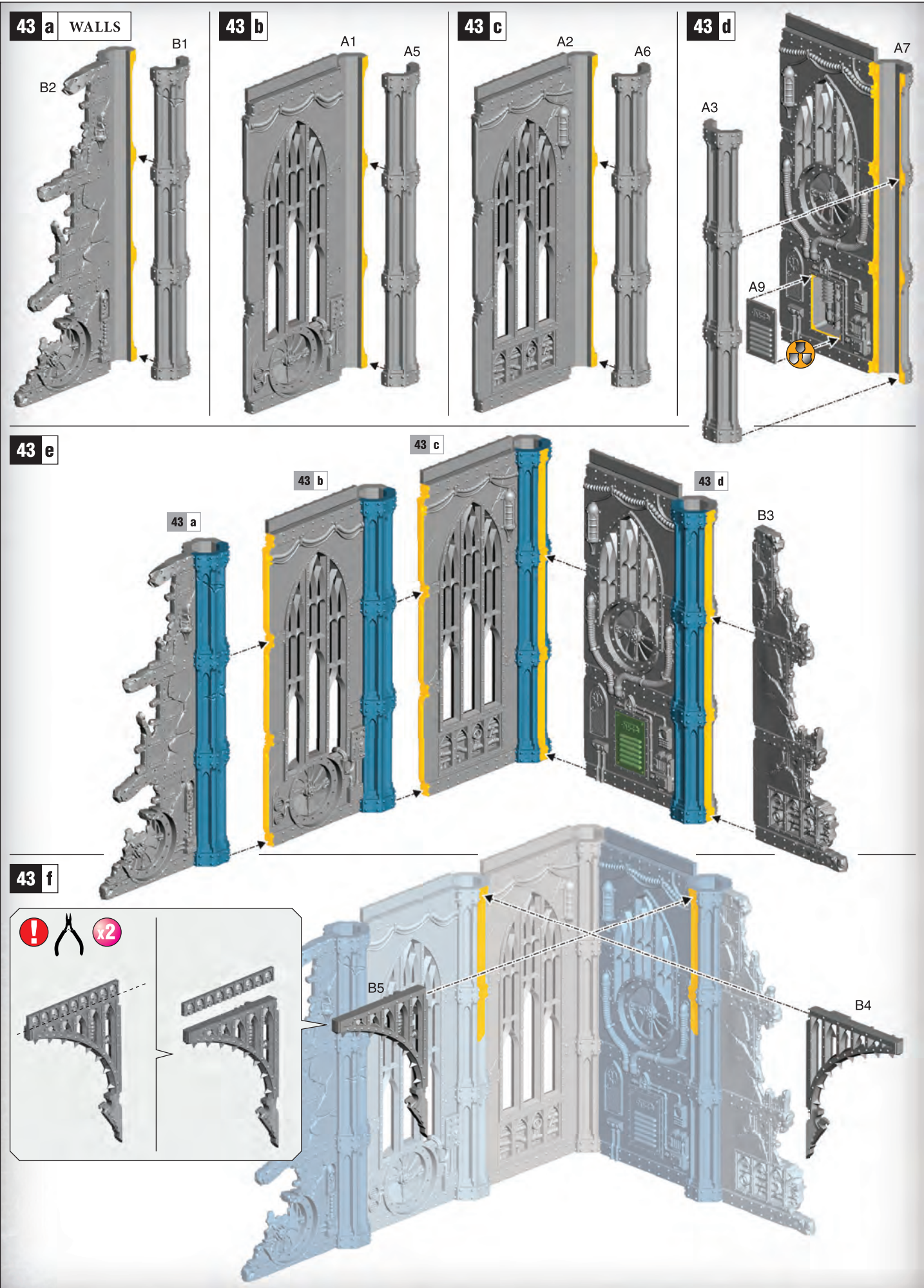

43 g

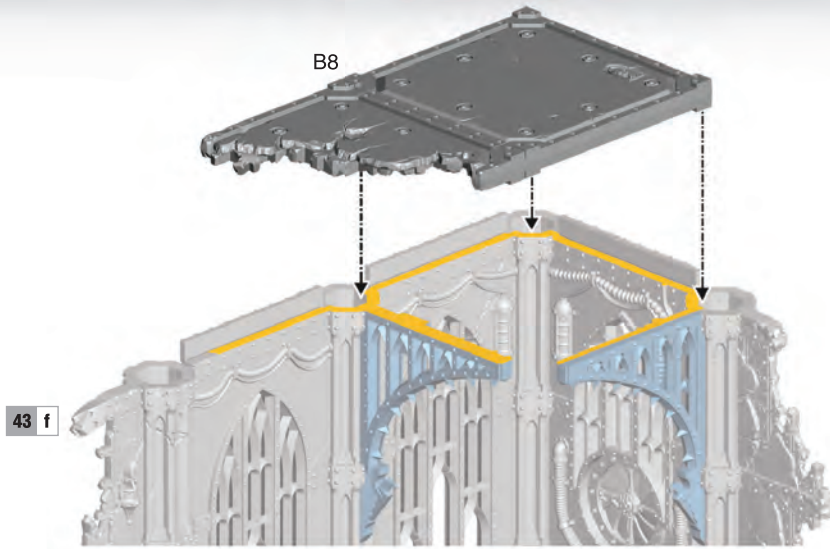

43 h

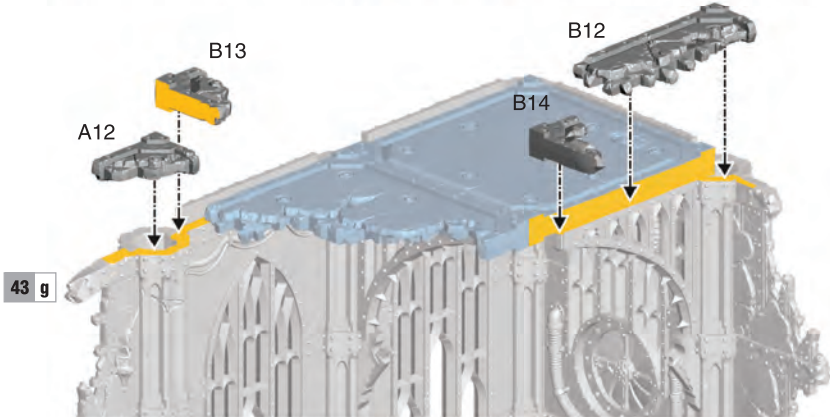

43 i

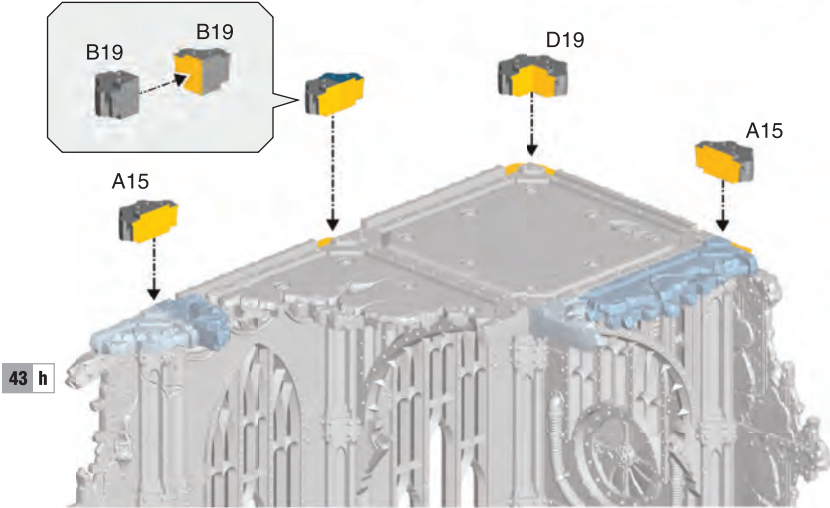

43 j

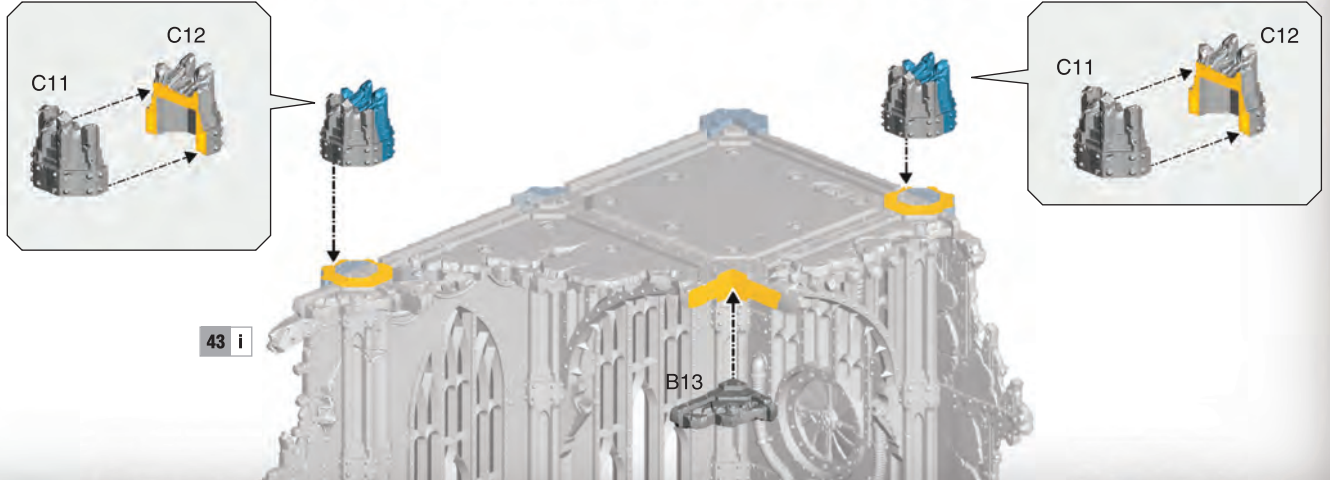

43 k

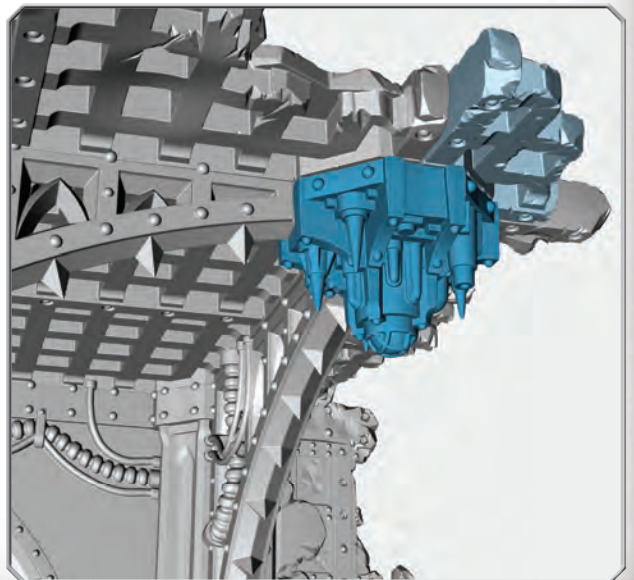
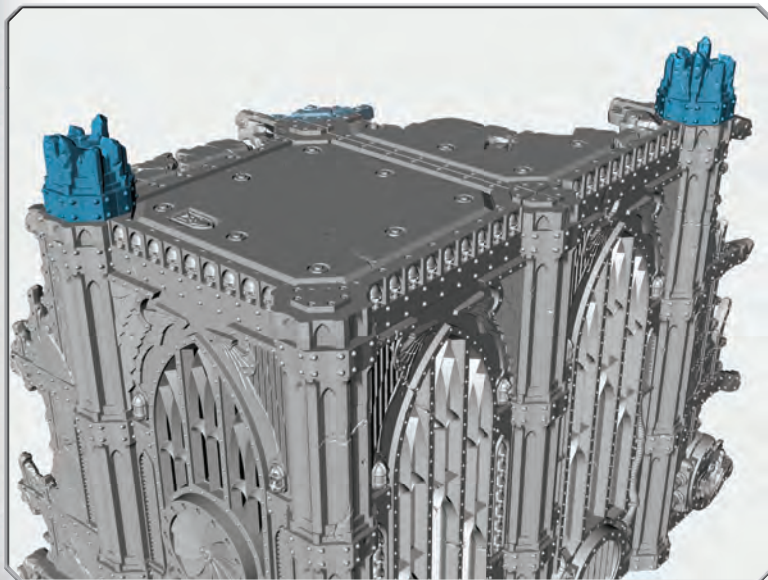
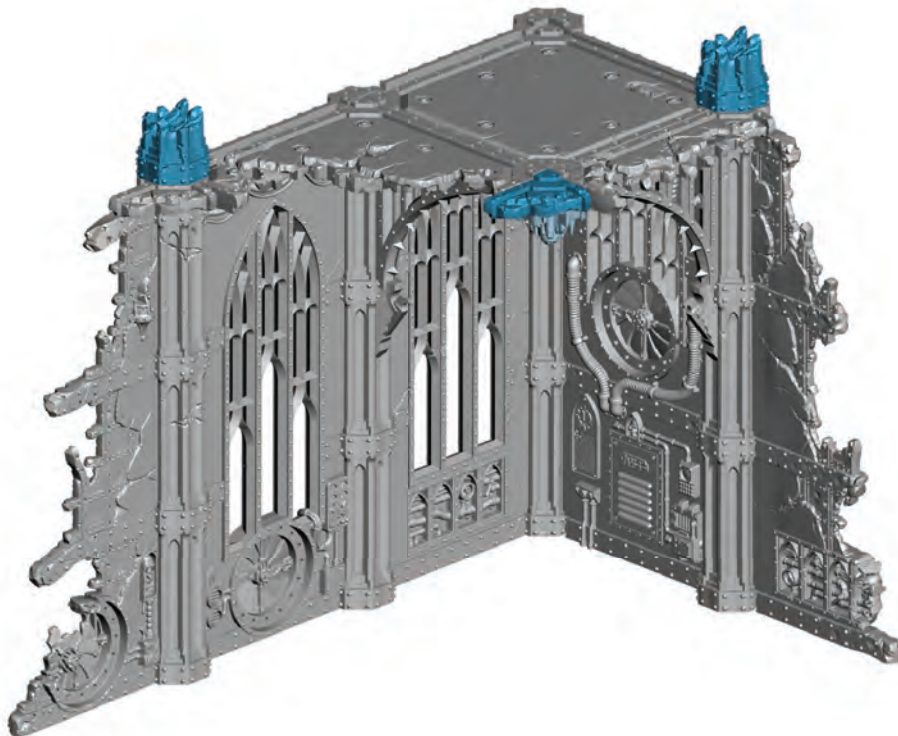
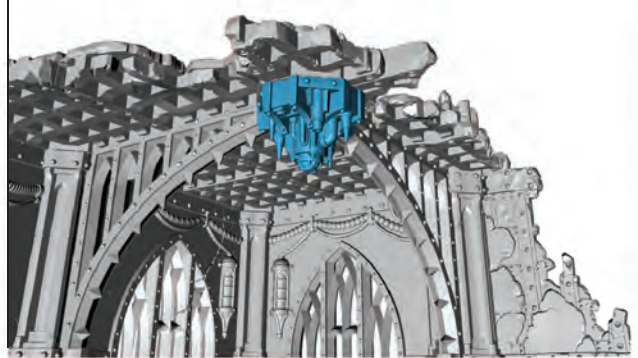
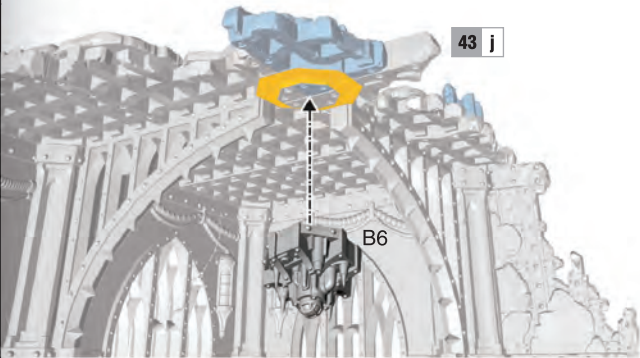

44 a CLOISTERS

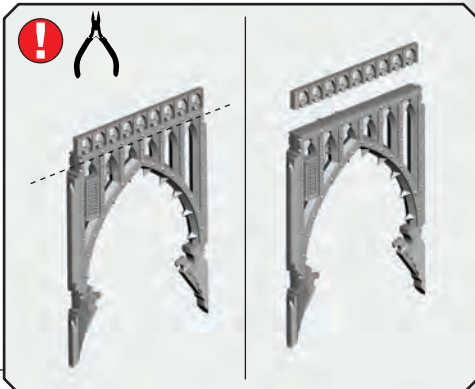
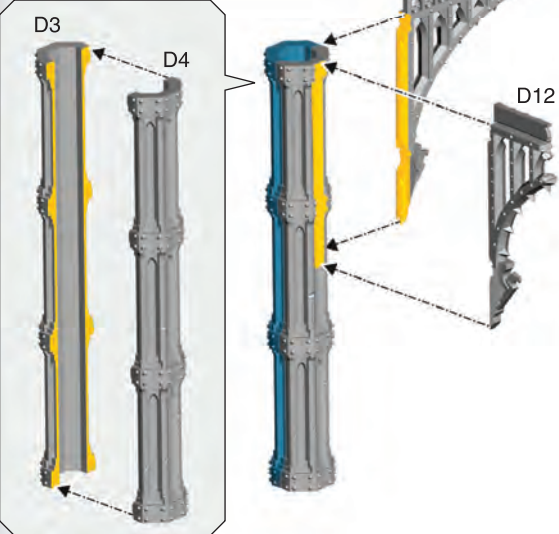

44 b

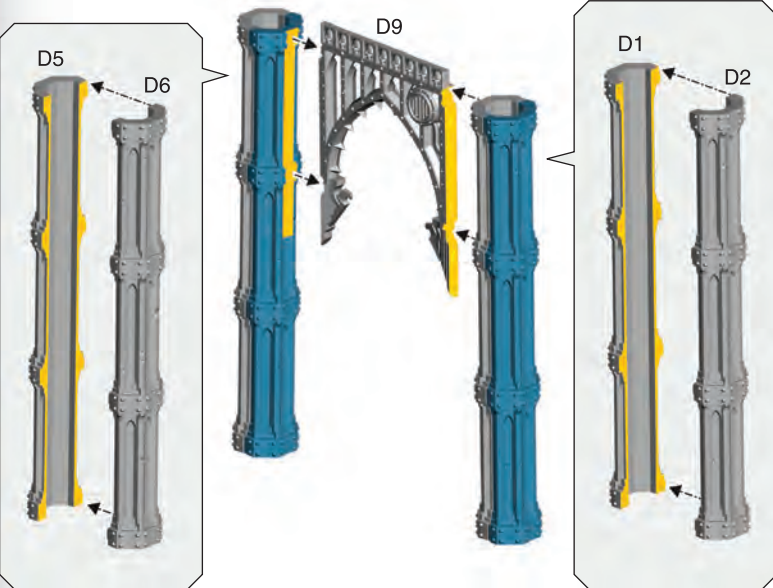

44 c

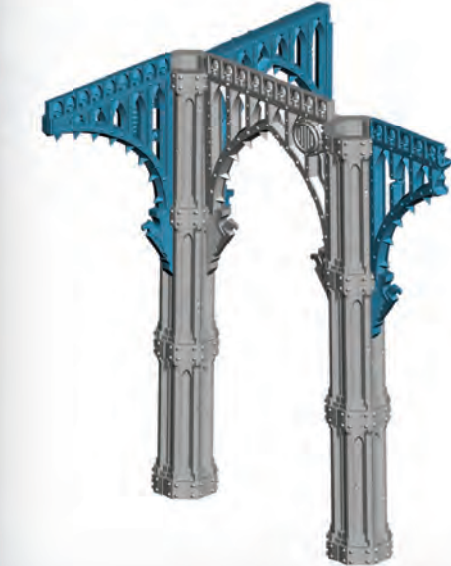
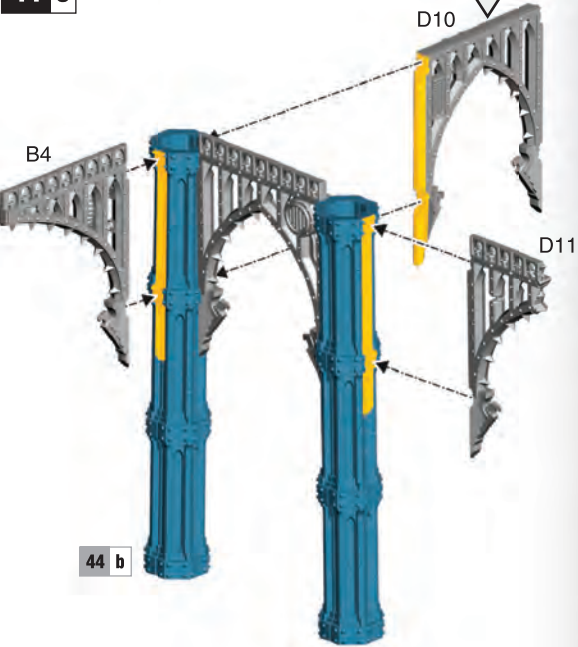

44 d

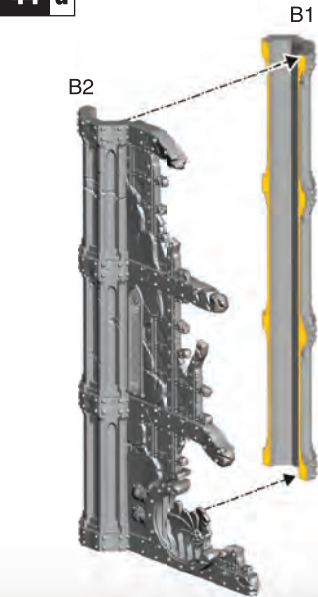

44 e

