

The Basic Fundamentals of Dimension Fusion

By *Selena Marie Gomez* and *Wilson Alzir Martinez*



*Dedicated to my dear friend **Selena Marie Gomez** may you keep inspiring the world as you have inspired me. May God bless you and your family as you have blessed me with the Wisdom, Strength, and Courage to move forward at times when I was at my weakest. Thank you for opening my heart and thank you for bringing light to my darkest days. I am forever thankful, grateful, and I am blessed to able to call you "friend". This Book is dedicated to all the women in the world.*

Son

An immortal man lacks defense, but an invincible man gains both.

Wilson Alzir Martinez



“Dimension Fusion is relatively new as a science and therefore lacks the rich background of knowledge already collected and digested that is available to the worker in the older sciences.”

Table of Contents

1. Preface.....	7
2. First Lightning Strike.....	13
3. Second Lightning Strike.....	34
4. Prologue.....	60
5. Section I Literature.....	65
6. Section II Mastery.....	73
7. Section III Representation.....	77
8. Section IV Dynamics of Color.....	91
9. Section V Color Equation.....	124
10. Section VI The Inversion of Colors.....	135
11. Section VII Recurrence Dimension.....	140
12. Section VIII Sequel Wavelet And The Super Sapien Hybrid Theorem.....	155
13. Section IV The Heavens.....	180
14. Section IX Holographic Dimension.....	186
15. Section X Ascended Sensation.....	191
16. Section XI Supreme Abilities.....	196
17. Section XII Bioscopology.....	198
18. Section XIII Inner Dimensional Travel.....	203
19. Section XIV Murder of the Nazi.....	212
20. Section XV The Obliteration.....	219
21. Section XVI The Basic Fundamentals of Dimension Fusion Review.....	225

III

I am the Mastermind



Preface

“For the nonbeliever I present”

“My philosophy is why should I time travel when I could create influences in my present and see my influences in the future without having the need to travel to the past and disrupt my present.”

Wilson Alzir Martinez

III

Greetings and thank you for taking the time to read my studies on Biological Mathematics and observations, this is my take at the most advanced sciences of life. My name is Wilson Alzir Martinez. My name would've bared the III initials W.A.R if I had my mother's last name. My mother's maiden name is Rivera. My name would've read out as Wilson Alzir Rivera. If my father decided not to be present at my birth. My initials bear the letter W A M. I like the comic book style of butt-whooping so I makes sense to me. [Traveling Dimensions is a long story]. Its kind of strange but I've noticed my birthmark and it is in the shape of a W and a 1 next to each other. Does this mean that when I was born my cells tried to create my name on my skin. As I was given the name at the time of my birth. Kind of strange if you ask me. My birthmark looks like this ₁W, I noticed it and I was surprised to see a 1 next to the W.

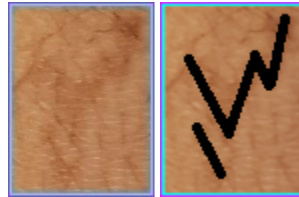

I one

It is as if my genetic code tried to spell my name. If this is true than my cells are very sophisticated in nature. Seeing that we are in a War, I will explain what my birthmark foreshadows. It means I won the war. W means War and I = 1. Hence the phrase I won, or I one. Potato Patato. I have witnessed militant people in my presence and they were the most foolish and the weakest that I have ever come across. They have tried to imprison me and failed to do so. This read will ensure the student and reader a worried free life. Militant men and women who take orders from commanding officers are the most foolish group I have ever encountered. I believe World War I and World War II were not necessary. The use of War is a strategy to rid of bad on earth. During the times that World I and II were ignited the bad were the ones who began the fire. The number III kicks into high gear as my Dimension Fusion identifies the bad. I and II were in no means necessary. I will begin this introduction with my past. I was born Monday, April 27th, 1992 at Ocean View Hospital in Hempstead, NY. My parent's names are Conce Martinez and Leonor Rivera. My parents came to America from El Salvador at a young age and gave birth to me and my siblings. I have Three brothers Luis Mario Rivera, Eder Franklin Martinez and Edwin Odir Rivera. I am the youngest. When I was an infant my parents decided to move down south due to my apparent lack of a strong immune system. My body couldn't handle the weather and I kept having colds. At the age of 2, they decided to move to Houston, Tx. I remained in Houston until I was 5 years old. I remember going to preschool in Houston but not very much of what was going on being that I was but a toddler. My parents decided to move to Dallas, TX. I would find myself residing in Irving, Tx. we moved into the Villa Martinique's in apartment 187 on 400 S. MacArthur Blvd. One of the many ghettos in Irving but I called it home. There was a lot of criminal activity such as murderers, drug dealers so on and so forth. At these apartments, we stayed away from illegal activities through break dancing and influencing the courtyard children in our complex about the arts of dance. Playing Hide and Seek was my favorite activity as a child. We would stay out late at night playing Hide and Seek. [Even though there was a lot of negativity I wouldn't change it.] Criminal activity knows no age boundaries as I would soon learn later on. I attended John Haley Elementary School which was right next to the Villa Martinique's. Apartment 187 was next to the fence of our schoolyard playground; one

could throw a rock from the schoolyard playground and hit the apartment. I attended grades Kindergarten through Fifth. After a short while, my parents moved us into a home away from The Villa Martinique's which has long since been torn down. We moved a block away from The Villa Martinique's, the residence we move into was located at 1502 W. 5th St. it was at this home where I endured challenges from the normal to paranormal the older I got. I eventually went on to Middle School. The middle school I attended was called Lorenzo Dezavala located at 707 W Pioneer Dr. Irving, Tx. Throughout elementary school; I attended *GT* (Gifted and Talented) classes. When I began middle school I was thrown so many projects that I failed to meet the requirements to advance towards the next grade due to me not wanting to pursue Honor classes anymore. (At the end of Fifth grade we were to create a science project and present it to the school. I didn't do mine. We were given a month and I fooled around the whole month.) And all I would find myself doing was sleeping throughout the classes. Heck at one point in eighth grade my the vice principal of eighth grade Mr. Grey thought I was on Heroin, he would pull me into his office and check my arms to see if there were any puncture marks from syringes. I would later find myself succumbing to peer pressure. Even though I slept half of the eighth grade I still for some reason managed to advance into high school. To be honest I believe it was because of my previous record of me attending Honors classes that had me advance to Irving High School. Or I was a bad influence and they wanted me the fuck out of the school. Either way, I advanced to the 9th grade. I attended three high schools. Irving High, Nimitz High, and Union Bower. Why did I attend so many High schools you may be asking yourself? Well because I was going through puberty and there were so many girls that I wouldn't pay attention, and after school I never did homework and I would party instead of study. I would get into fights and smoke pot in the restrooms and consume heroin in class. I wasn't a Grade A Student. My GPA is 62. I never made it passed the tenth grade. I was expelled for Irving High School. I failed to graduate the high schools that I attended and ran into loads of trouble after I failed to become a productive member of society. Most of my life I have been trying to seek knowledge and I come to realize that true knowledge doesn't come in written form. It comes from experience and close observations. Recently I have wanted to study the history of America. Americas True History. It can only be found beyond textbooks. The textbooks that they present at schools are the biggest illusions and false information that I have ever read. As you can tell the founding fathers of this nation were not educated at all and have created fables in which there are no questions after reading those fables. If it were true that they were highly educated then the sequence of events that have been unfolding recently would make sense, but as you begin to question America's history and its sense of logic you will conclude that the founding fathers' pattern of evolution is downright absurd. I never attended college, (obviously) but if I did I would've studied biology or something of that nature. I attended two full years of ninth grade and two full years of the tenth grade. I failed each one and had to retake the grade. Hence why I had to take those grades twice. In 2007 I ended getting addicted to Heroin and from 2007 to 2018 I had been addicted to Heroin. Up until recently of last year in May. May eleventh to be exact, I decided not to pursue my Heroin addiction. Most of my elders consume prescription drugs. Well, it's not that easy to obtain a prescription of what is needed. One goes to the doctor and it is according to the doctor what they will prescribe and I sure as hell wasn't going to slave for a wage of \$7 an hour just to pay for the prescription when the main ingredient for what I had been addicted to was cheaper than the prescription itself. A woman inspired me to become the person I am today and whom I am going to become. She goes by the name Selena. (For quite some time, during my observations of Telepathy throughout this past year I kept hearing the name SEL. For some time it got on my nerves because I didn't know who the heck SEL was. Until about a few months ago.) She is a very special woman and she's a big part of my life since I was a child and she gave

me the realization of my potential in life. I dedicate my writings and teachings to her and her family. This is a subject created by Love. To my understanding, it is the first of its kind. She has made me an active member of society to a certain extent. I say to a certain extent because it's my choice to stray away from the Lemming Human beings that follow on a daily and never pick up something new through their observations. They never question. A lack of understanding of life will create an illusion and the average human will end up missing out on the true meaning of life and in my opinion, I believe it is to create. The fact is that society doesn't know the harmful effects of being amongst the crowd. I have found out through the years of my Heroin binge that I haven't been subjected to Subliminal Brainwashing and on top of many more things that the average human has forcibly subjected to every second of every hour of every day. I'd like to thank Heroin for suppressing the psychological weapons that the secret government throws at the masses daily. Since I consumed so much heroin I didn't pay attention to radio frequencies and I never followed the crowd. Maybe that's why Heroin users are considered dangerous.

Manipulation has voided the learning experience to the Average human in today's Era. Today being 2019. In 2011 I would find myself heading to prison for a year and in 2013 I headed back to prison and that stay only lasted 3 months. It is in prison where I took full advantage of the education system and I had managed to obtain a G.E.D. through sheer boredom I decided to take the exam and managed to pass it without any problems. Before my second stay in prison, I met a woman named **Anna Lisa Rodriguez**. She was born March 24th, 1994 in Dallas Tx. she has also been a big part of my life. She gave birth to my children. I have three children. **Angel Nichole Rodriguez**, **Genesis Elise Martinez**, and **Alexyz Alzir Martinez**. I also dedicate my writings to my family. They have given me strength through the ages and never gave up on me. I recently decided to join the military however when I gave them a call they were using color codes. The officer that I was to communicate with was named something that triggered my mind into being alert. They created a world where RED means STOP and that's exactly what my train of thought did. My Intelligence far surpasses the Nations army that is "All-Powerful". The recruiter (officer) named Nathaniel **RED** was whom I was to contact if I was never contacted, But he eventually contacted me in which I responded with an obvious go fuck yourself. I have found out with my own experience. That from the day you are born you are fighting for your life and that has come to an end. On April 20th I got my hands on the book created by the one they call Albert Einstein and it took me three weeks to breakdown his equations to what they were and are. On May 11th of 2019 is when I finished my breakdown of his equations. From the moment I got the book called "A General Theory of Relativity" I noticed the odd forms of variables placed. As soon as I opened the trash of a book. The first page I turned to when I opened the rubbish was page 16. I took my time to type up the book instead of reading the illiterate trash heap. It is indeed one of the most illiterate books I have ever laid my eyes on. It is on the same level as a book I read last year called "Who Blowed up the Church House". Which is why I decided not to read it. The book is a book of war and how to keep the war going in the 21st century and the centuries that follow. Just as a conquistador would, I rightfully conquered Albert Einstein. I have found the book of war by a General of the Third Reich. His name was Albert Einstein. The book of General Relativity was keeping the Mechanics in the world repetitive and it seemed as if there was no end to the so-called Classic Mechanics. I **Wilson Alzir Martinez** have defeated the tyrant's reign by identifying the book as what it is and I broke down the scripture to the very end. Just like how their predecessors would have done to other ancient civilizations I have done so to theirs. The book is the modern "Art of War" by "Master Sun" aka Sunzi. I have alerted the world's powers and gave them light to such a dark era. I have discovered how to telepathically communicate with other dimensions and I am giving the power to the world as a true ruler does. That power and other powers amongst the Basic Telepathic Communication. These men under

Einstein created a system since children we are watched by these puppeteers and I have defeated them one by one. These puppeteers are not human but ancient beings that were still resonating on earth. It is as if these Ancient Beings were controlling them. Slowly you will see changes around your reality. My reality is crashing into your reality making it beautiful and strong. I suggest you be observant. In this read, you will learn how to advance your consciousness and create with simple mathematics. I have conquered Einstein and used his style and *Fused* his style with mein. Creating the ultimate and superior form of Science and Mathematics. There are no laws when it comes to **Dimension Fusion** making the subject with no boundaries. The possibilities are infinite. With no Laws in the subject of the matter, Dimensions will be limitless. Other than the original dynamics of color which are laid out as a foundation for visual purposes and Dimension. Even the original dynamics of color are bound to change as everything does. **Dimension Fusion** is relatively new as a science and therefore lacks the rich background of knowledge already collected and digested that is available to the worker in the older sciences.¹ Dynamics takes over the Classical Mechanics that were previously reigning at the beginning of the 21st century. The Dynamics will not be a secret as you will see that secrets end up crumbling a nation. I have chiseled the last piece of granite of a nation with my initials. The Dynamics of changing Classic Mechanics will be the foundation in this subject. Although relatively new as a science it will become greater than what the cowardly creators of the Classic Mechanics in the past. D [Dynamics] is Greater than C [Classics] and that's the beginning of the Dynamics of Classical Mechanics. Many know of the mechanics but lack the knowledge of originality and cheat. With no trial and error, there will be no advancement. The Space-Time Continuum was destroyed by me. With the Mushroom Clouds², I was able to see where my enemies were and remained silent as I concocted a creation that can move through Dimensions. I discovered that time has always been a measurement and leaving the term time travel a contradicting subject. No matter what time they believe it is my creation is always a step ahead as it is unknown. As a snake would prey on the unsuspecting rodent, I have struck as quick as a **Lightning Bolt** and consumed and inherited what is rightfully mine. As my Dynamics floods the system with *W* I will remain observant. The Classic Mechanic of Defeat is used for the rodents on my planet. D/C [Dynamics over Classics] I am King; Dynamics over Classics will remain the influence as we move through Dimension. There will be changes around your reality when this subject is read. The intelligence level will increase as you will grasp my knowledge and continue the process of moving Dimensions as I have. There will be a feeling of relief as you begin to control your reality. Once the subject is picked upon; the subject itself will advance. *Earth* is where the subject originated. Mars Beware, Earth has entered the fight. Mars was the God of War in ancient times; (I Found out Mars derives from my last name Martinez.) since we do not live in ancient times I have gained control of the rotating earth and will begin to guide it. I am God Of Destruction. The Roman Empire has finally seen its last days as I The God of Destruction have finished my observations and have come to the conclusion that The Romans (Reich) are not fit to rule as they have created pestilence in the playground and have caused their weak nation to crumble into dust beneath my feet. Cathedrals and Monuments will be removed as we cross Dimensions. The world's powers will see it fit that the tyrants who have created the paths that were forced upon the children are none other than a disgrace to the world and will agree for elimination. Biological Construction [BC] will continue as it has done before and will begin what is known as Natural Elimination. $E=Mc^2$ will be but a shadow left on the pavement by the power of *My Ancient Destruction* [AD]. As we journey through Dimensions it is imperative for the reader to remain conscious of what occurs after the subject has been picked up. If the reader lacks that power of consciousness then they will miss the changes that have been brought before them. Their leaders have educated their families with nonsense and rubbish. My children's playground and your

children's playground will remain clean as we see fit. As I the God of Destruction I see it fit that the God of War remains Eliminated in the tournament of power. Einstein the Romans Heir of knowledge is eliminated leaving the Romans completely defenseless and my calculations rein dominate over the land that is earth. My technique of eliminating Masonic Symbolism through Dynamic Intellectual Equations (DIE) will reign supreme amongst the "Elite" that once was. The Destruction of Symbolism will be demonstrated throughout the reading. Equations of the utmost intellectual will be shown in this reading. It is the reality of the "Future" and will not be ignored. The Power of this read will give the reader the knowledge they seek to advance into a more productive member and will cleanse their nature of thought and offer a better life of well being. It is in Human Nature to Evolve. The repetitive cycle is what Einstein and his men created to stop the evolution of mankind. These calculations will reprogram the reader into its natural state. A sense of relief will be felt as the reader is enlightened. Einstein's definition of insanity is doing the same thing over and over and expecting different results. That is where the state of mankind is in 2019. Einstein was a fool. Evolution is placed back into the cycle of life after these studies. My name is [Wilson Alzir Martinez](#) and I am the creator of [Dimension Fusion](#). D Secret Masonic Symbolism has been laid out all over the world. Those secret layouts are somewhat like doors to whomever unlocks the secret message behind those symbols. Those "Gray Aliens" who are actually Rodents who evolved before us were the ones who laid out the assassination location where John Fitzgerald Kennedy was murdered and placed all the secret symbolism only the smartest person was to figure out the assassination location and the symbolism of the assassination $E = MC^2$ is laid out as the location. This is trigger an alarm so to speak and big brother the person who discovered the symbolism. I happened to inform the world before these things could try and manipulate me. We have been communicating back and forth, but I only insult them for they are rodents in wormholes. It doesn't surprise me that these aliens have been communicating with me Telepathically and through the T.V. Sets. and through the radio waves. The Alien beings leave Masonic symbolism throughout the world as a trap so they can identify who the smartest person is. Unfortunately for them I crossed their path and had the rudest smartest mouth the world has ever heard, they were expecting someone who was polite and quiet. I am not polite and quiet when it comes to Aliens. I alerted the C.I.A, FBI and NSA in a terroristic manner so they can behold who the enemy is. I am no terrorist I am just a genius. September 12th, 2019 during a candidate debate I, Wilson Alzir Martinez found the Alien Threat. Turns out the Aliens Human Hybrid program has been successful for quite some time and I have gained the right to communicate with them. I communicated with them live. They only communicate to the world's most intelligent being. I am that intelligent being. I was not supposed to communicate vocally; I have been insulting these fools telepathically. I decided September 12 to be the day I call them out during the debate. Joe Biden stated "Oh come on guys, you people act like you barley found out about this."Beto O'rourke mentioned Fusion during his debate. And he also mentioned a man named Luis. There is no coincidence. I have a brother named Luis and I am the creator of Dimension Fusion.

III

As above, So below

The Roman numeral III is a W and an M. The term "As above, So below" is displayed in the Roman numeral III

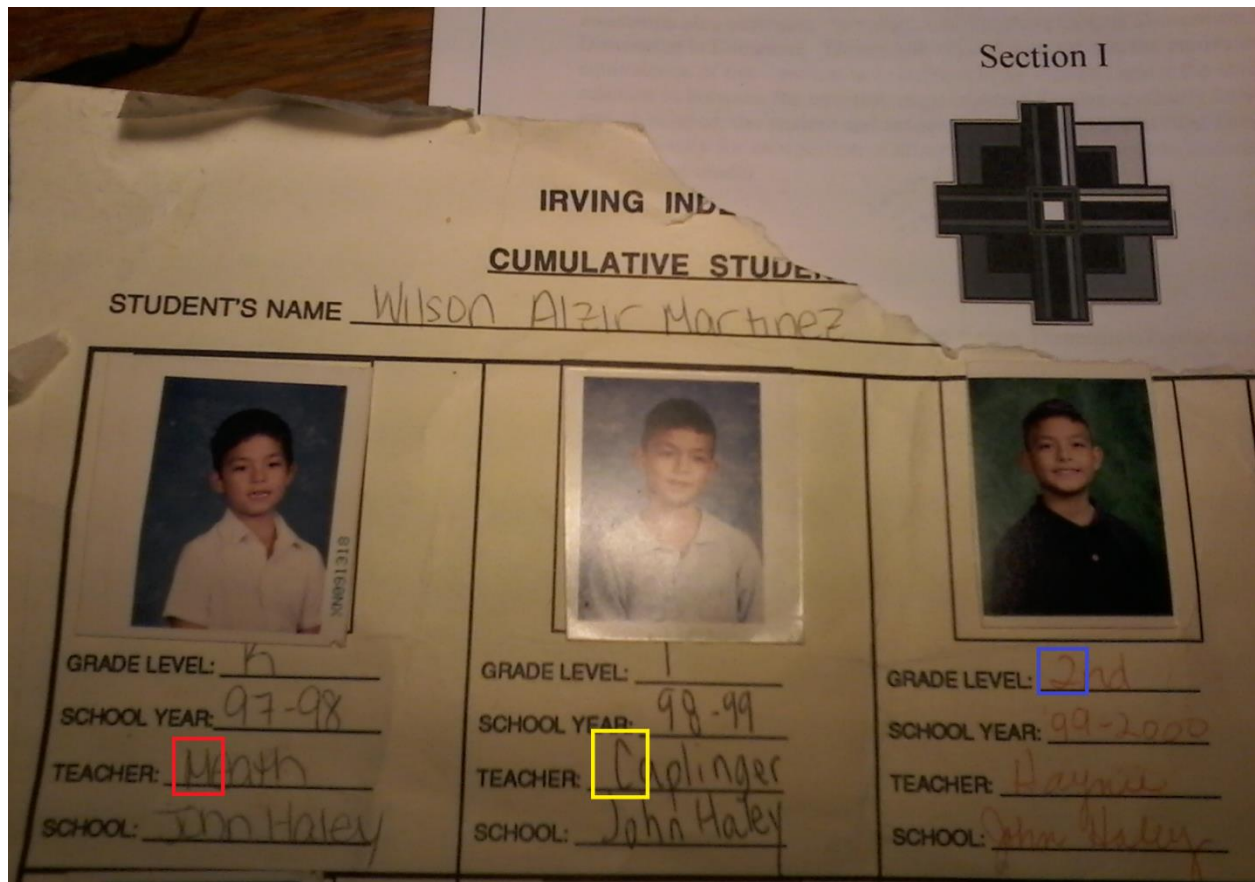

MC²

In grade school, My Kindergarten teacher was Ms.Meath. Her surname bears the M in MC². My First Grade teacher was Ms.Caplinger, her surname bears the C in MC². As you can see above, I display an image of my Grade School photographs. MC² is present. The 2 sits above the initials MC, making MC2 look as follows. MC². As I have stated in the previous pages, this literature ensures the safety of humanity as a whole. Dimension Fusion is not for a specific race. It is for Humanity as a whole.

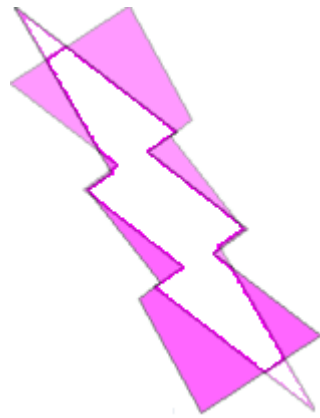

First Lightning Strike

First Lightning Strike

The equations that ruled the world will be broken down as I demonstrate the equations mechanic. $E=MC^2$ is obliterated and is given no mercy. The Obliteration is caused by my doing, Wilson Alzir Martinez. Let's jump right into the past and let me begin story. In the 4th Grade my peers and I from grade school went on a field trip. I found myself in Dealey Plaza. 1963 began the reason why students were brought to this location. At 12:30 P.M. 1963 Two Shots struck John Fitzgerald Kennedy, The 35th President of The United States. I don't remember much, but as time went by I found myself at times thinking about that field trip. Little did I know that I was being used in a C.I.A. operation. The operation was successful. On January 22nd, 2019 I took a trip down to Dealey Plaza and discovered whom the conspirators were. This makes me the youngest C.I.A. member. At the age of 9, I was thrown into a world with evil men. These evil men ran tabs on all the children that were placed at this location. They ran tabs on each child. A dangerous operation. Throwing children into political and mafia environment isn't such a good idea. I made it unscathed. I realized why I was such an important person. I was smack dab in the middle of the crossfire. Two decades of my life I have been fighting The Secret Masonic Order. Two decades of information I hold and have shared it with the world. Not a single penny was offered to my name. Why? It was a secret operation. You think a 9 year old is going to be told what is going on and why they are there. I was in the Gifted and Talented program. I believe this field trip to Dealey Plaza was booked every year after the assassination took place. John Haley Elementary School was the school I attended when I went to the field trip. Mr. Slaughter was the principles name. The Secret Masonic Order places last names and first names in men and women to display a message. Mr. Slaughter in my opinion symbolizes the slaughter of any children or any teachers that discussed what they find at Dealey Plaza. For god sakes the name of the school refers to both men that died on November 22nd, 1963. John and Lee. John, Hey Lee is the name of the school. John Haley. Before making my discovery of who conspired against The President of The United States, I made my way to downtown Dallas. George W. Bush's father had just passed away. The night he passed away I vandalized a Masonic Lodge. I went to visit a memorial. The memorial is a gigantic block. The Block represents John Fitzgerald Kennedy's head and the Two Shots the murdered the president. While I was working on this textbook let Dimension Fusion I remembered the monument that is a memorial to John Fitzgerald Kennedy didn't have a statue. The head statue is missing. A hologram will replace the head statue.



Holographic Status

The head of the statue is the whole statue itself. The plaque that the statue is sitting on is called a plaque the statue that is sitting on the plaque in the John Fitzgerald Kennedy memorial is missing. This is symbolism for the shot fired at The Presidents head. It is a symbol from The

Secret Masonic Order. I figured since My Dimension Fusion will become a success I will place a hologram of John Fitzgerald Kennedy where the missing head stone is at. The walkway of the monument represents the shot that went through the esophagus of the president. The second shot that killed the president is displayed as the roof of the monument. There is no roof on that monument. Signifying the president's head being blown off. Below is a photograph from Google images. The monument is a disgrace to The United States of America and will meet its reconstruction with My Dimension Fusion's Hologram. There will water surrounding the hologram giving the presentation as sense of excellence. The monument is located at 646 Main St, Dallas, TX 75202



The Monument



The Hologram Location

Taking a break from Dimension Fusion, I went down to take a video of where my hologram was going to be placed. I made it to the location and found myself stalked by one of George W. Bush's family member. I walked into the monument and saw two men and a child. I spoke to one of the men. "Hey, you guys know there is going to be a hologram here?" I said. One of the men

said “Sure” being a dick. The other man said “Really?”. I walked away and went around the monument. For some reason people always follow me, they end up losing their lives in the end. I walked around the monument and snapped a photograph of the man who is George W. Bush’s family member. It is a genetic code that goes unspoken. Notice the genetic structure of this man and the fool named George W. Bush. As I waited for him to walk out of the monument, I pulled out my phone and stood with my camera displaying on the phone. He walked right into my shot. Below is an image of one of Bush’s Men.



Which way did he go George, Which way did he go?

I caught another photograph of the other man who was waiting for me when I got there. Remember I painted a Masonic Lodge before this. All eyes have been on me for quite some time. I had no idea. Below is another image I managed to catch. The man was playing peek a boo.



Peek a Boo

I was thrown in a secret operation and I have been fighting for my life since the day I was thrown in the operation. The secret operation was successful I am the person who brought success to this operation. I have been working for the Central Intelligence Agency since I was 9 years old. With no consent. I believe this operation of sending children to the Six Floor Museum was a strategy on both sides. The good side of The Central Intelligence Agency and The corrupt side of The

Central Intelligence Agency. The good side of The Central Intelligence Agency were sending children to look for clues; The bad side of The Central Intelligence Agency were listening and gang stalking children's families. The whole operation was under surveillance. I went to the museum in 2001. I knew something was strange when I noticed the resemblance between the man and George W. Bush. Below is an image of The Renaissance Tower in Dallas, Texas.



x^2

X2

This equation is under the selection called Script. X means to eliminate. Times 2 is what I call the equation above. Two X's marks the spot. The Renaissance Tower in Dallas, Texas displays Two X's running alongside of its build. It creates somewhat of a light show. The mechanic of Two has been used throughout the century. Two Atomic Bombs, Two Bullets to assassinate a president and Two Planes and Two Towers, This Renaissance Tower could indeed symbolize 9/11 Attacks. It displays Two X's on a building. Let's not forget this building sits right across where President John Fitzgerald Kennedy was assassinated. Hence why X marks the spot. The Assassination Location displays Two X's where Kennedy was shot on the pavement floor. Below is an image of one of the X's that displays where John Fitzgerald Kennedy took a bullet. Remember there are Two X's. My question is does the C.I.A. know about secret symbolism, because if they did they would've intercepted The 9/11 Attacks. How so? Well take a look at the image above it displays Two X's on a building.



X marks the spot

A Scripted Equation

I discovered the equation above while typing up Dimension Fusion, I have been creating my own equations as you will see later in the read and I stumbled upon this equation above. I call these equations Abstract Equations. This Abstract Equation (\mathcal{A}) symbolizes the victory of The Twin Tower Attacks in New York. I call them Abstract Equations (\mathcal{A}) because it is up to the viewer's perception to make out the equation. The creator and someone with the imagination that is up to par (such as myself) with the creator knows what the Abstract Equation (\mathcal{A}) really means. President George Bush was sitting in a classroom of Second Graders. The II mechanic is displayed in the grade they were in. George Bush's advisor used 11 words to inform the president that America was being under attack. Those 11 words were "A second plane hit the second tower America is under attack". The 11 words were 11 is a classic mechanic used by the Nazi. It stands for Two Lightning Bolts, in this it stood for Two Towers. The Roman Numeral II or 11 resembles Towers. After the attacks George Bush addressed the people of America with Psalm 23. W is the 23rd letter of the alphabet. These men use Masonic symbolism. letters from the alphabet represent agendas. I go into further detail on the 9/11 Masonic Symbolism below.



Bush Vs. Gore

The Image above is from Google Images, the image is of the two candidates of 2000. The name Gore is name symbolism. Gore is defined as blood that has been shed, especially as a result of violence. The Secret Masonic Order uses name symbolism. The classic mechanic of 1 and 2 is used in Albert Arnold' Gore's Name. The Al in Albert Arnold Gore represents A1. A1 is defined as very good or well; excellent. The A in Albert represents the number 1. The name Arnold in Albert Arnold Gore represents another 1. Arnold is a German name. A is the First letter of the alphabet. Hence why the letter A is referred to as a number 1. The organization Al-Qaeda is equivalent to A1-Leaders. The word Qaeda is defined as Leaders. Al Gore and Al Qaeda have striking similarities in their name. The mechanic of 1 and 2 is used in this disaster that was 9/11 to signify who was responsible. The world leaders know who uses the mechanics 1 and 2 as a signature in their disasters. The Romans who evolved into The Nazi use the mechanic of 1 and 2. 1 is present in their name and the number 2 has been displayed as Two Atomic Bombs, Two bullets to assassinate a president and in this paragraph I am discussing the Two Towers that were attacked. The L in Albert represents a number 1. It represents Two Roman Numeral ones placed next to each other. Al = II, place these Roman Numerals next to Gore and it reads out as II Gore. The name Albert Arnold reads out as II as well. For Albert begins with the letter A and Arnold begins with the letter A. The Roman Numeral II represents the Twin Towers, and Gore

represents the bloodshed and sacrifices that the Twin Towers produce when they are attacked. I attended Dezavala Middle School, in the 8th Grade during the election between John Kerry and George W. Bush. It was during 8th Grade that we as the student body were given an assignment. The assignment was to Vote. It was through the computer. The votes were electronic. I believe that George W. Bush used these electronic votes from our school to boost his votes during the election. I don't know if all the other schools in Texas or in The United States did this, but I remember vividly given an assignment and having to vote for a President through the computer. This strategy gives the candidates who are being voted for the biggest advantage for ballads are cyber and are done through computer. I'm sure other Presidents of The United States have used this strategy as well. They create an illusion by telling the student body that it is a practice run. In reality I believe we as the student body were used to vote and the ballads were counted as actual adult ballads. It was during History Class, my history teacher in the 8th grade First Semester was Mrs. O'Neal, 4th period. I believe I had Mrs. O'Neal 6th period Second Semester. I remember sleeping throughout my 8th grade year. I recall my Vice Principle calling me and a buddy of mine into his office because he got a complaint from the teacher saying that we slept too much in her classroom. He asked us if we were on Heroin. He asked us to show him our arms for puncture marks. The way I remember things of the past is the same strategy used as the young man in the movie Slum Dog Millionaire. Horrible things happened to the young man in the movie which helps him in the long run when he is on the show "Who wants to be a millionaire". The questions that the young man must answer tie in with his life. He answers the question correctly. The answers to his questions were met while growing up. Slum Dog Millionaire is one of my favorite movies. It is amazing how someone in a slum could become rich beyond his wildest dreams. I injected heroin today and it made me think of that day in 8th Grade. It is August 31st, 2019. I know heroin isn't a good thing and I'm not proud of it. I don't go through withdrawals anymore and I've learned to only do it once a month or once every three months until I am full off of heroin. I used to do it every day for ten years. It's a start. I mean ten years every day abusing heroin to once a month or once every three months. Not too shabby. At least I don't have a badge like some of you folks carry around and act like I don't consume drugs. Half of you people who carry badges either smoke crack, smoke meth or smoke weed. So don't act like this changes the fact that I'm better than you. I am better than you in all ways. I have increased my intelligence to know that I am better than substances and I know how to control my old addiction. I'm weaning off, what can I say. hey at least I'm honest. When we took "The voting lessons online" we were told it was to prepare ourselves for the future. Although the teacher said it was to prepare the student body for voting. I believe they used these votes to help win the election of Bush. We voted online. I believe I voted for George Bush. I'm not too sure, but I remember voting at the age of 13. I remember this vividly because Hurricane Katrina had just hit New Orleans and we had transfer students from Louisiana.



George W. Bush Turnpike

I live off right next to President George W. Bush Turnpike, I have observed that this highway only runs north and south. They either lead to the DFW Airport or away from the DFW Airport. The highway has the classic mechanic that the Nazi use. Classic Mechanic of Two. In the past there were Two Atomic Bombs, Two Shots to Assassinate The President of The United States, and Two Twin Towers that were attacked. The Highway represents the Twin Towers, for the

highway has two lanes, north and south. Airplanes fly right above The Highway. 3100 State Hwy 161, Grand Prairie, TX 75052 is the address where I live next to. This address is called Trinity Trade Center. George W. Bush Turnpike is called 161. The Secret Masonic Order of Numerology plays in this number. 1 represents the First Tower or One Lightning Strike of the Nazi, 6 Represents a G for German, and the other 1 represents the Second Twin Tower or Second Lightning Strike. The Highway is labeled as SH or State Highway. SH represents the word Hush. For when you tell a child to hush you say sh. Bush has the SH discreetly hidden in his name. which means to keep quiet. Stephen Hawkins also bears the SH in his name. His initials spell SH. It is a Nazi rule to label in secrecy. Another disaster that spells the same symbol SH is The Sandy Hook Elementary School. There was a school shooting at Sandy Hook. I went to John Haley. The name John Haley references the Two Deaths that occurred during November 1963, I am familiar with symbolism and all flags point to the Hoax of Sandy Hook. As I went to a school whose name referenced the biggest conspiracy in American and the Principle name was Mr. Slaughter a threat in the form of a last name. I am just observant that is all. I am fully aware of the symbolism and numerology. The reason I say Lightning Strikes is because the SS symbol is Two Lightning Bolts. This is why the mechanic of Two is always used in disasters. If the number Two is displayed in an attack or event that is considered a threat and creates a state of emergency such as the Two Atomic Bombs, Two Shots to kill a president, or Two Towers destroyed. This is to indicate which Tyrannical country led the destruction. It is somewhat of a signature. This is why I have been discussing Classic Mechanics. Two represents Germany. The Nazi. 2 airplanes plus 2 towers equals 4. China4. C4 is used for demolitions. I will explain China's signature in [Colors](#). I do believe China is the first dynasty to create black powder. Black powder is an explosive invention. Below is the signature of The Nazi represented by Two Lights that represent Two Lightning Bolts, the Classic Mechanic of Two Lights substitutes what used to stand there. The image below is from Google Images.



Two Lightning Strikes



Meet The Twins

After the 911 Attacks happened George Bush Jr. is seen presenting a comedy act with his Twin. He is an impersonator; goes by the name Steve Bridges but the symbolism of what the act represents is clear. The impersonator states “Speaking of Suspects, where is the great white hunter?” George Bush Jr. interrupts and says “I’m sorry, vice president Dick Cheney couldn’t be here tonight” meaning that Dick Cheney was the one who instructed the 911 attacks. Also be advised that George Bush Jr. has Twin Daughters.



Jenna and Barbara

These Twins above represents the hatred that the attacks placed against George Bush Jr. His Twin Daughters created the perfect scapegoat for beginning a war. You may be asking yourself how I figured out The Classic Mechanic of Two? Well on page 25 of Einstein’s The Special and General Theory of Relativity, Section 8 it begins with the

Sentence. “Lightning has struck the rails on our railway embankment at two places A and B far distant from each other. The image below is Section 8 from Einstein’s literature. The piece of literature is called The Special and General Theory of Relativity.

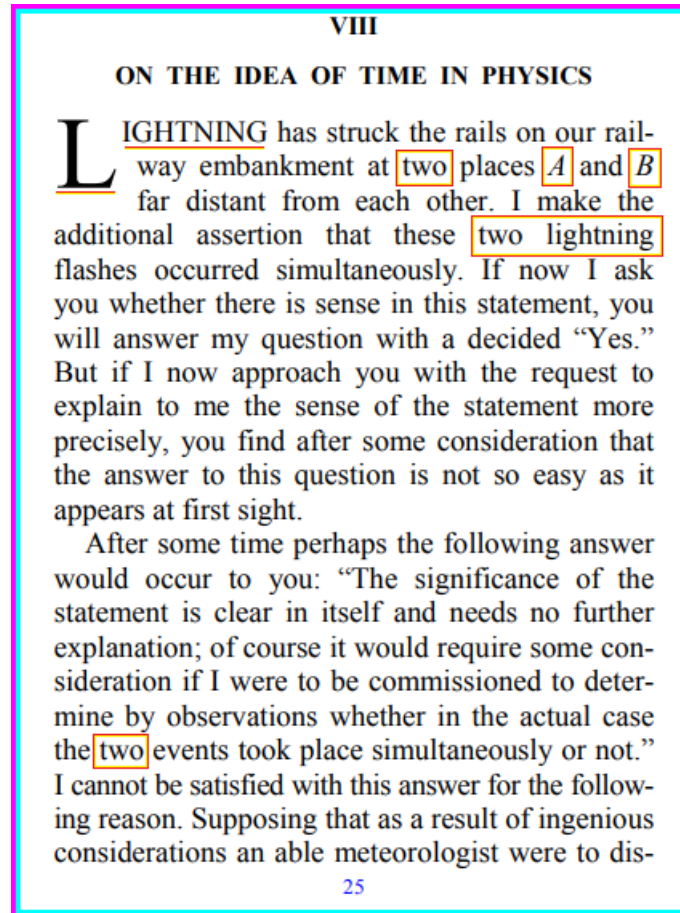

Lightning has struck the rails

Another reference of Two Lightning Strikes is found in the next Section, Section 9, Page 29; Paragraph Two of Einstein’s The Special and General Theory of Relativity. It is no coincidence that the reference of Two Lightning Strikes is on Paragraph Two. The reason it is Paragraph Two is to show the secrecy of their symbolism, this whole book is symbolism. The page numbers are symbolism, the paragraphs are symbolism. Everything in this book is symbolic. It is from The Secret Masonic Order. Einstein’s book is laid out in this format to pay allegiance to his Fuhrer also known as Adolf Hitler. Displayed on the next page is the Second Reference of The Two Lightning Strikes. Einstein’s pieces of literature must be looked at with an imaginative mind. I, Wilson Alzir Martinez studied Einstein’s literature with an imaginative mind. I was never taught about Einstein therefore giving me the full advantage when I began studying his literature. Studying Einstein’s literature with an academic eye will lead to a dead end. With an academic eye, the student feels obligated to produce and answer. The academic eye is a prisoner to the human mind. An imaginative eye enables the human mind to be free.

IX

THE RELATIVITY OF SIMULTANEITY

UP to now our considerations have been referred to a particular body of reference, which we have styled a "railway embankment." We suppose a very long train travelling along the rails with the constant velocity v and in the direction indicated in Fig. 1. People travelling in this train will with advantage use the train as a rigid reference-body (co-ordinate system); they regard all events in reference to

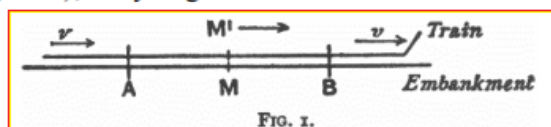

the train. Then every event which takes place along the line also takes place at a particular point of the train. Also the definition of simultaneity can be given relative to the train in exactly the same way as with respect to the embankment. As a natural consequence, however, the following question arises:

Are two events (e.g. the two strokes of lightning A and B) which are simultaneous with reference to

30

Two strokes of Lightning

Paragraph two begins with the sentence "Are two events (e.g. the two strokes of lightning A and B). The Classic Mechanic of Two has been used by this family since biblical times. Jesus Christ was nailed to Two Sticks. Which formed the Crucifix. The Roman Empire's signature has been the number Two. Crucifixion were done with only one stick back In those times. You may have noticed the figure above is an example from The Basic Fundamentals of Dimension Fusion. I labeled the figure in The Basic Fundamentals of Dimension Fusion as Einstein's Atom Boom. It was mine for the taking so I placed it in my literature that is The Basic Fundamentals of Dimension Fusion. I broke down Einstein's equations and his Space-Time Continuum. I have accomplished what was considered the impossible. As Einstein's read continues the mention of Two Lightning Strikes that represent points A and B . Point A represents The First Atomic Bomb and Point B represents The Second Atomic Bomb. All of Einstein's literature are books of war. I managed to get my hands on this copy that is The Special and General Theory of Relativity and I broke down the equation that were in Einstein's favor. They are the equivalent to Sun Tzu's Art of War. The Special and The General Theory is nothing more than a gigantic metaphor. It strategically lays out plans for war. The book I acquired is sectioned off in three parts. To my understanding each part represents each war. Part I is World War I, Part II is World War II, and Part III is World War III. I believe that Part III of The Special and The General Theory deals with Space. Einstein discusses the term "Empty Space" in the book. Empty Space means exactly that. There is nothing in outer space for human beings, these men use the term Space-Time Continuum as a metaphor for the conquer of space through time. The more time they buy the

more their plan is successful. Space-Time is a metaphor itself. These men have laid out literature in metaphor style. Sometimes reading between the lines doesn't work when the reader doesn't comprehend what the literature is discussing. Reading this book with an academic eye, the reader will only come to one conclusion and that conclusion always favors Einstein and his calculations. Advancing his calculations. Reading Einstein's The Special and General Theory of Relativity with an academic eye gets the reader nowhere. The reader who looks at Einstein's literature with the academic eye was given the definitions for what each variable stood for. Einstein laid out the questions and answers therefore leaving the reader of this literature in a dead end. Although the mathematician creates new calculations from Einstein's literature only advances Einstein's Rule. I looked at the book called The Special and General Theory of Relativity with an Imaginative eye. Giving me full advantage from the moment I opened the book. I noticed the patterns and figures that Einstein demonstrated. I didn't know anything about Einstein before I opened the book. I never paid attention in school, therefore giving me the full advantage of reading his equations from a wanderer's point of view. I the wanderer found myself in a new environment, the environment was called The Special and General Theory of Relativity, as the stranger I approached this new environment with caution, the mass of people wandered in this environment blind. I engaged in reading the signs (Equations) in this environment and I calculated the signs actual significance. One of the signs read $E = MC^2$. The mass of people were blindly lead into believing that these signs (Equations) would point them to the directions to the stars. I calculated the signs (Equations) and lead the mass of people towards the light. The Signs in this environment kept man-kind in a state of darkness. Remember the significance of A is Atom and the significance of B is Bomb. Part III in The Special and General Theory begins with the letter A. The first letter displayed is an A; the A's Significance is Atom. The next section of Part III begins with a B; the B's significance is Bomb. The literature in symbolic format reads as Atom Bomb. A B. the significance of AB is Atom Bomb. The next section after the A and B is another A. the significance of this A is 1. 1 is pronounced as Won. Although it is spelled with an O N E. The number 1 is symbolic for a victory. Below are the pages that displays the Atomic Bomb's direction. One is pronounced as Won hence why Einstein used the letter A. in symbolic format it reads Atom Bomb Won.

<p style="text-align: center;">PART III CONSIDERATIONS ON THE UNIVERSE AS A WHOLE</p> <p style="text-align: center;">XXX COSMOLOGICAL DIFFICULTIES OF NEWTON'S THEORY</p> <p>A PART from the difficulty discussed in Section XXI, there is a second fundamental difficulty attending classical celestial mechanics, which, to the best of my knowledge, was first discussed in detail by the astronomer Seeliger. If we ponder over the question as to how the universe, considered as a whole, is to be regarded, the first answer that suggests itself to us is surely this: As regards space (and time) the universe is infinite. There are stars everywhere, so that the density of matter, although very variable in detail, is nevertheless on the average everywhere the same. In other words: However far we might travel through space, we should find everywhere an attenuated swarm of fixed stars of approximately the same kind and density.</p> <p style="text-align: right;">125</p>	<p style="text-align: center;">XXXI THE POSSIBILITY OF A "FINITE" AND YET "UNBOUNDED" UNIVERSE</p> <p>BUT speculations on the structure of the universe also move in quite another direction. The development of non-Euclidean geometry led to the recognition of the fact, that we can cast doubt on the <i>infiniteness</i> of our space without coming into conflict with the laws of thought or with experience (Riemann, Helmholtz). These questions have already been treated in detail and with unsurpassable lucidity by Helmholtz and Poincaré, whereas I can only touch on them briefly here.</p> <p>In the first place, we imagine an existence in two-dimensional space. Flat beings with flat implements, and in particular flat rigid measuring-rods, are free to move in a <i>plane</i>. For them nothing exists outside of this plane: that which they observe to happen to themselves and to their flat "things" is the all-inclusive reality of their plane. In particular, the constructions of plane Euclidean geometry can be carried out by means of the rods, e.g. the lattice construction, con-</p> <p style="text-align: right;">128</p>	<p style="text-align: center;">XXXII THE STRUCTURE OF SPACE ACCORDING TO THE GENERAL THEORY OF RELATIVITY</p> <p>ACCORDING to the general theory of relativity, the geometrical properties of space are not independent, but they are determined by matter. Thus we can draw conclusions about the geometrical structure of the universe only if we base our considerations on the state of the matter as being something that is known. We know from experience that, for a suitably chosen co-ordinate system, the velocities of the stars are small as compared with the velocity of transmission of light. We can thus as a rough approximation arrive at a conclusion as to the nature of the universe as a whole, if we treat the matter as being at rest.</p> <p>We already know from our previous discussion that the behaviour of measuring-rods and clocks is influenced by gravitational fields, <i>i.e.</i> by the distribution of matter. This in itself is sufficient to exclude the possibility of the exact validity of Euclidean geometry in our universe. But it is conceivable that our universe differs only slightly</p> <p style="text-align: right;">135</p>
---	---	--

Atom Bomb Won

My name is Wilson Alzir Martinez. I was born April 27th, 1992. I am 27 years old. For a mechanic to be classic the creator of the classic mechanic must begin with the First Optical Dimension, The basic line that runs left and right. After the mechanic is written out, then comes the use of The Second Optical Dimension. Mastery is used to create the visual blue prints that will eventually become The Third Optical Dimension. Third Optical Dimension is Representation. Before one builds a car, one must write down the plan of the cars layout (First Optical Dimension). Then one must draw the layout (Second Optical Dimension), and then after the layout is drawn then the build begins (Third Optical Dimension). I have demonstrated who the nazi are in America. They were political leader. Donald John Trump is Nazi. His 45th position equals $9.4 + 5$ equals 9. America was infiltrated by Nazi before it could even be called America. The student and reader has now been revealed The Classic Mechanics of Two. It doesn't surprise me that there are Two candidates who are opposing each other in the end of the election. As I have stated before, my observations from Grade School which began in 1997 to 2019 have been recorded in my head and I am writing down my observations. As a young a child I never said much. I was mute. I observed more than I spoke. I believe I am the youngest Central Intelligence Operative that has ever been placed in an operation. I believe I am also the youngest and the most successful out of every operation in history. I'm 27 years old. My name is Wilson Alzir Martinez. I have been creating calculations and have been displaying much success. Without a doubt, in my perception I am the hardest hitting person who has ever walked the earth. I have collected data from observations and I never wrote anything down. This Dimension Fusion is the first thing I have typed up since I was in school. The last time I was in school was in 2009. I dropped out of high school before my class graduated. I was sitting across smoking weed with a friend and laughing because we should've been across the street practicing their graduation with our class. My class is class of X. or Class of 2010. My observation throughout the years have been brought up once again. I am now displaying my observations in this literature. Below is a picture from The Special and General Theory of Relativity. The Author of the illustration is named Hermann Struck. The illustration made its debut in 1920. 100 years ago.

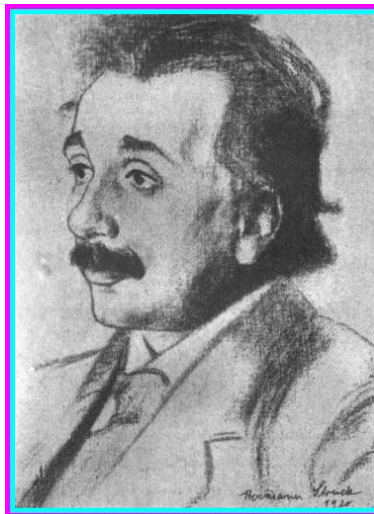

Lightning Has Struck

The name Hermann Struck is equivalent to Lightning Strike, Struck is past tense for Strike. The secret symbolism is displayed in names. As shown in the authors name of the illustration above. Hermann Struck is the authors name of the famous illustration. The illustration is of Albert Einstein.

The image below is Part I of Einstein's Special and General Theory of Relativity.

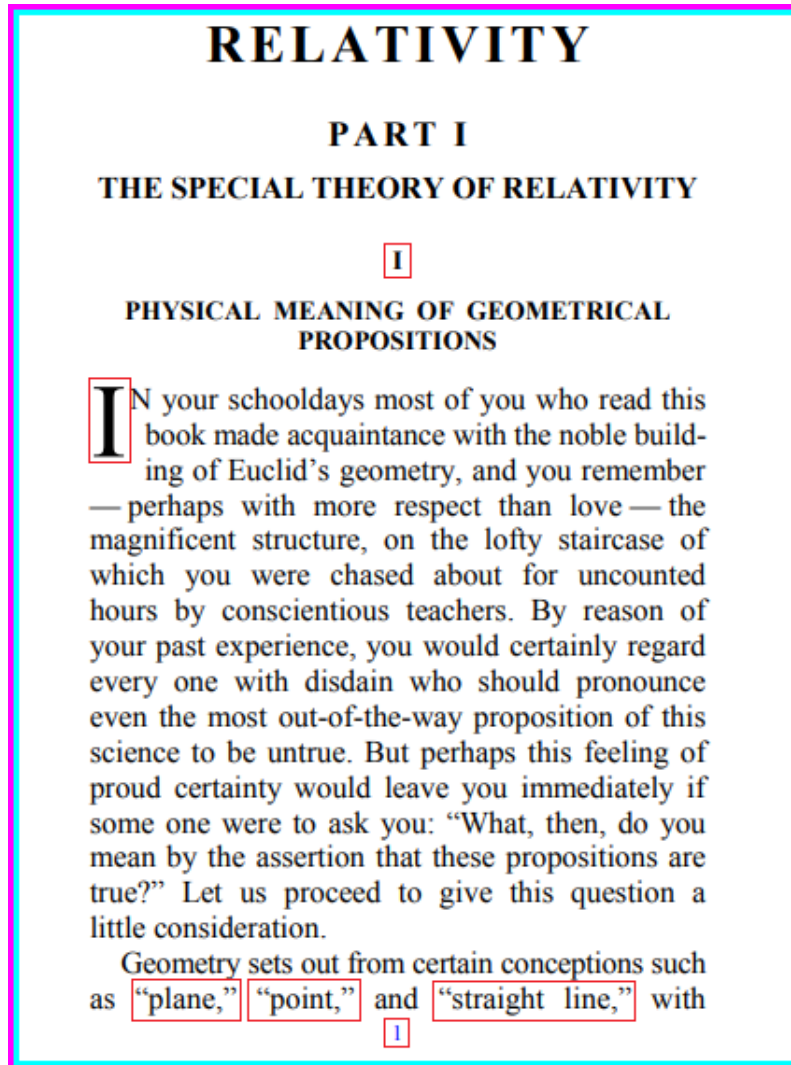

First Strike

“Physical Meaning of Geometrical Propositions” is the first section of the literature. It is Section One. The title secretly reads “Physical Meaning of Geometrical Professional Positions Won. The words Professional and Positions are fused together and create a new word. Propositions is the outcome of Professionals Positions. This part of the book discusses the embankment of the plan of the Atom Bomb. The second paragraph symbolizes Atomic Bombs, hence why the mathematics terms “Plane” “Point” and “Straight Line” are proposed in the second paragraph. “Plane” represents the Air Plane in which the Two Atomic Bombs are carried in, “Point” represents the location where the Two Atomic Bombs will be dropped on, and “Straight Line” is the path in which the “Plane” carries the Atomic Bombs and drops them at the “Point” The I displayed in a large font symbolizes victory. One is pronounced as Won. This is the first page of the literature hence why the plan is first proposed on page one/won. The image displayed on the next page is Section Two of Einstein's Special and General Theory of Relativity.

II

THE SYSTEM OF CO-ORDINATES

ON the basis of the physical interpretation of distance which has been indicated, we are also in a position to establish the distance between two points on a rigid body by means of measurements. For this purpose we require a “distance” (rod S) which is to be used once and for all, and which we employ as a standard measure. If, now, A and B are two points on a rigid body, we can construct the line joining them according to the rules of geometry; then, starting from A , we can mark off the distance S time after time until we reach B . The number of these operations required is the numerical measure of the distance AB . This is the basis of all measurement of length.¹

Every description of the scene of an event or of the position of an object in space is based on the specification of the point on a rigid body (body of reference) with which that event or object coin-

¹ Here we have assumed that there is nothing left over, *i.e.* that the measurement gives a whole number. This difficulty is got over by the use of divided measuring-rods, the introduction of which does not demand any fundamentally new method.

Second Lightning Strike

The second section of the book is titled, “The System of Co-Ordinates”. The roman numeral II is displayed above the title. Although it is to notify the reader of the section number, it represents Two Lightning Strikes. The reason they use Lightning as a metaphor is because Electricity is power, hence why Lightning is their metaphorical weapon. The section secretly reads out as “The Two Systems of Co-Ordinates” the Two Atomic Bombs co-operating with each other for victory. The section begins with On. The O is in a large font. On translates to Ein in German. The significance of placing On in the section which displays the Atomic Bombs represents a possessive representation of ownership. As I discussed in the previous page the word “Point” secretly means the location where the Atomic Bombs meet. “Two Points” is displayed in the second sentence. A comma is equivalent to a period. The display of secrecy is written out in simple literature mechanics. A and B are proposed for the first time in this read. A and B symbolizes Atom and Bomb, for these words being with A and B. a number ¹ is displayed after the proposition of the use of A and B in this literature. The significance of 1 is not for a side note to define the paragraph as authors use the numbers as, but is a secret way of symbolizing the embankment of the plan that is proposed by these men.

XI

THE **L**ORENTZ **T**RANSFORMATION

THE results of the last three sections show that the apparent incompatibility of the law of propagation of light with the principle of relativity (Section **VII**) has been derived by means of a consideration which borrowed two unjustifiable hypotheses from classical mechanics; these are as follows:

- (1) The time-interval (time) between two events is independent of the condition of motion of the body of reference.
- (2) The space-interval (distance) between two points of a rigid body is independent of the condition of motion of the body of reference.

If we **drop** these hypotheses, then the dilemma of Section **VII** disappears, because the theorem of the addition of velocities derived in Section **VI** becomes invalid. The possibility presents itself that the law of the propagation of light *in vacuo* may be compatible with the principle of relativity, and the question arises: How have we to modify the considerations of Section **VI** in order to remove

36

LT is Lightning

The image above is chapter XI, 11. It speaks on the Two Atomic Bombs in a secretive manner. The Lorentz Transformation is a secret subliminal way of speaking of Lightning. The L and T in The Lorentz Transformation are present which indicates the reference to Lightning. The T in the word The that introduces the Lorentz Transformation is a secret subliminal way of saying Two. This chapter continues the discussion of the Two Atomic Bombs in a secretive manner. The significance of the V in VII is Victory. The significance of II in VII is Two Atomic Bombs, Two Lightning Strikes. After the Roman numeral message the literature continues with numbers 1 and 2. The numbers 1 and 2 references the Two Atomic Bombs that will be released. The significance of the word “Drop” is used as is. The way you release an Atomic Bomb is by “Drop. As you can see from this page the layout is quite extraordinary. The reason it is on Section 11 is because the number 11 represents Two Atomic Bombs, or Two Lightning Strikes. The Number 11 and the Roman Numeral II are the same thing. The book fascinates me, it made me realize how easy it is to manipulate a nation and how to destroy with no strings attached. Einstein was praised for this feat. I look at the book with amazement at how much secrecy is laid out in the book. The first time I looked at this book was April 20th, 2019, I opened the book and looked at one page and saw the amazing secret format. I couldn’t help myself but to analyze the literature. Every equation in this literature is a plan to win a war. I have mastered the art of equations and have created my own calculations. America was infiltrated by a man called Albert Einstein a German native who worked under the rule of $F = 4\pi\gamma^2$ or also known as Adolf Hitler. I was

surprised to the words Fuhrer secretly in a equation. the world's number 1 enemy was in the land of the free. Albert Einstein infiltrated America and helped The Nazi win World War II. Take a look at the name World War II and you will see the mechanic that is II. II symbolizes Two Atomic Bombs. It is no coincidence that II Atomic Bombs were used in this War. Everything in the world is mapped out in a secret manner; the student and reader have been informed that Einstein was indeed a Nazi General of World War II. The Roman Numeral II also signifies the railroad tracks that were used a form of transportation that gave these men the advantage in war. They set up the railroads tracks paths before the War began, giving them "Godly" speed to reach point A and Point B in the War. They used the art of speedy transportation and the element of surprise in World War II. As I have stated before these literature mechanics have been used in literature for hundreds of years. I have mastered the art of literature and have laid out my Dimension Fusion to the exact extent of the literature of Einstein. You never know my literature can be a book of war itself. Below is displayed Albert Einstein's Signature.

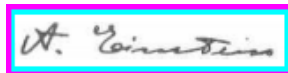

The Signiture

Fact is my literature stretches beyond Einstein and the many "Genius" before and after the man. Also, The name Albert Einstein is symbolic itself. It reads a A. Einstein, which means One member from the Einstein family. Einstein was praised for his imagination because he placed war plans on a piece of literature. As I have identified the letter A as 1 gives the name Albert Einstein a whole new meaning. Einstein's signature read as A. Einstein. Symbolizing the victory of the Einstein family. In government documents the name Albert Einstein reads as Einstein, Albert. The comma separating the two. Now the name in a government document reads as Einstein 1. Symbolizing the victory of the Einstein Family. Adolf Hitler has the same mechanic as his name is displayed as A. Hitler, the A in Adolf represents 1 or Victory. 1 is Victory. In a government document it would read as Hitler, Adolf. Hitler 1 is the significance of Hitler, Adolf. 1 is pronounced as won, which means victory. Albert and Adolf also demonstrate the mechanic of II. Each of their names present a Roman Numeral I. Albert was the smartest General working under Adolf Hitler. This is why Einstein was chosen to infiltrate America. Little did Americans know that there were Nazi Officials in the American Army sending millions of American to perish Remember these Nazi chose where the battles were going to take place before World War II began. They used Trains to reach from one location where a battle was to commence to another location where another battle was going to take place. The Railway System that is displayed in The Special and General Theory of Relativity speaks about the Railways and nothing more. The title of The Special and General Theory of Relativity should read as The Generals Special Theory of Reality. It speaks nothing more than reality itself. Re means to Repeat, hence why Relativity is spelled in such a manner. It means to repeat the process and continue the evolution of this process. The Railway System were used to send millions of Germans and Jews into Concentration Camps. As sad as it is, The Einstein family met their fate in those gas chambers. The words Concentration and Camp bear my mechanic C². C² is my mechanic. The first letter in Concentration is the C in C² and the C in Camp is the ² in C². With my Dimension Fusion it is possible to go back in "Time". I do not call time travel I call it Dimension Fusion, for Time is just a measurement, Dimension is a matter of perception meaning I am the only person who understands Inter-Dimensional Travel. It's no fantasy for I have the calculations that create Dimension Fusion, hence why Einstein's family was placed in Concentration Camps. The name Concentration is a pun. How is one able to Concentrate in a

Death Camp? Dimension Fusion is without a doubt a tool of destruction. I destroyed and with my destruction came creation. The destruction of Einstein's Space-Time Continuum was met at the hands of Wilson's Dimension Fusion.



The Psychic and III

Modern Predictive Programming is visible to the viewers of America in 1940. The still image above is from The Three Stooges' film called "You Nazty Spy". The camera captures the 8 ball at an angle where the 8 resembles a B, when it is presented by the psychic. The 8 ball falls from the sky as she waves her hand in a hypnotizing way. The Psychic and The Three Stooges sit down and begin their meeting. The Three Stooges Larry, Moe and Curly begin to make sounds of a Train and an Atom Bomb falling from the sky. Predictive Programming has been used throughout centuries. A famous man named Nostradamus was known to the world as a man who predicted the future. He "predicted" future events. In reality Nostradamus was, in my opinion a head man who ruled the world during his time in secrecy. He wrote down future events and these events panned out as planned. It is a strategy that these men use. They write down their plans for future events and those plans become reality. Plans were written down hundreds of years before Nostradamus' death. Before he passed he wrote down centuries of plans that made our reality. This means Wars, and events that made our reality to what it is today. The truth is; Nostradamus was not a psychic. The man was a ruler of The Secret Masonic Order. Nostradamus devised plans for the future. The world saw this man as a man with godly powers. Sadly, this is not the case. Men of this day hold plans of Nostradamus for these plans are what create future events. Nostradamus was the Einstein of his century. Einstein wrote down plans and had these plans become reality in turn made his group a running success.

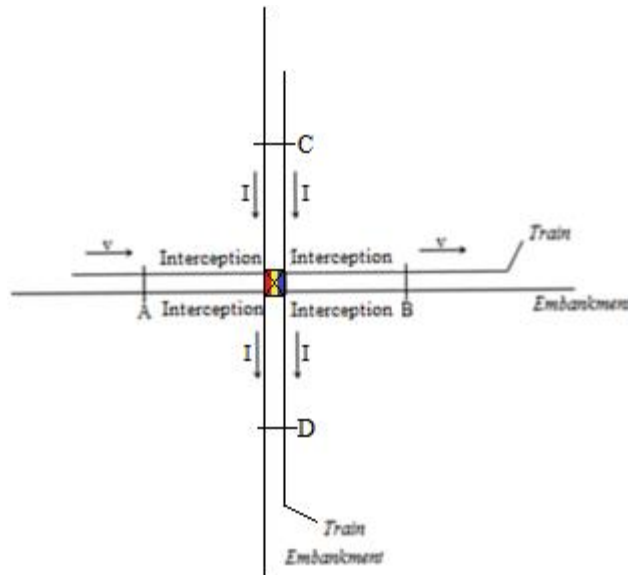

Phase I

I demonstrate Context Sensitive literature in Dimension Fusion. Phase I is the reconstruction of Einstein's Railway system. I broke down Einstein's equations leaving me to do with Einstein's equations as I please, this includes his diagrams. It's natural that I as the Viper devour the Rodent³. I identified R₃ (Third Reich) and eliminated their transportation with P¹ (Phase I). P¹ is infinite, π is also infinite. Just as Einstein used the first two letters of the alphabet I continue his alphabetical layout. I am adding C and D to the layout. The reason D is 4 is because D it is the fourth rail on the railway system on which the railway carriage must make its way towards. The numerical order follows suit with the alphabetical order A¹, B², C³ and D⁴. The format of Einstein is childish if you ask me, but as the saying goes "one must learn how to crawl before they can walk." A is 1 and B is 2. Point A¹ and B² are the embankments of Train 1¹², the embankment of Train 1¹² is East and West; Horizontal. Train 1¹² is always on schedule. Train 2³⁴ is a random occurrence and halts Train 1¹² in its direction of the embankment. C is 3 and D is 4. Point C³ and D⁴ is the embankment of Train 2³⁴, the embankment of Train 2³⁴ is North and South; Vertical. The need for a 1 in 2³⁴ is not necessary for 1 is the Train in which we have duplicated therefore creating 2. Train 2 is 2³⁴. The Primary Colors display the Interception connection that enables a new horizon. The Primary Colors in The Interception of A¹ and B² displayed above represents the rotating clock that halts Train 1¹². The path of Train 1¹² is interrupted by Train 2³⁴. Point C³ and D⁴ run along towards a new embankment. This Railway System by yours truly is the Interception that the world has needed for quite some time. The motion of the counter clockwise rotating base will keep Train 2³⁴ from colliding with Train 1¹². Counter Clockwise the Dynamics of Train 2³⁴ embanks towards a new horizon that extends vertically over the horizontal path that is Train 1¹². Counter Clockwise is C³ and Dynamics is D⁴. The first letter of Counter Represents the C in C² and the C in Clockwise represents the 2 in C². The Definition of Dynamics is the forces or properties which stimulate growth, development, or change within a system or process. The Elimination is displayed as Train 2³⁴ crosses paths with Train 1¹². The motion of Train 2³⁴ is vertical; while the motion of Train 1¹² is horizontal. The mechanic of X is created as 2³⁴ intersects 1¹² completing Phase I. The X is completed by the intersection of Train 1¹² by Train 2³⁴ hence why Phase I. I is a mechanic that means victory thus I name my figure Phase I. This proposition states that the railway carriage or T¹² is interrupted by the second railway carriage T³⁴ it heads in an inverted direction interrupting T¹². I, Wilson Alzir

Martinez am countering the mechanics of Einstein. Just as one would rewind the clock counter clockwise³; I, The Destroyer of Space and Time continue the destruction of Einstein's Space-Time Continuum. W's are displayed on the Railway Systems in my name. Dimension Fusion is the key success to The Obliteration of The Space-Time Continuum. The dynamics of Dimension Fusion eliminates the classics of Albert Einstein. Below I continue the annihilation of Albert Einstein with X. I have observed the complete guide of secrecy in equation form as I picked up The General's Special Theory of Reality also known as The Special and General Theory of Relativity. It was with this literature that I was able to comprehend the unexplained and it was this literature that gave me the key to the holographic universe. Dimension Fusion is my literature and as I opened the door to the holographic universe via Einstein's literature, I managed to conquer the holographic state of mind; I am king. I am the only person who comprehends 100% of how the holographic universe works. With this state of consciousness I have completed the conquer of the matrix or holographic universe. This has been a battle between Einstein and I since I was a child. Since we are born we are thrown in a fight for our lives; I am the victor therefore I set the people free. I have godly powers and I demonstrate them and teach them to the student and reader, although I'm 27 years old my intelligence far surpasses whoever is considered the smartest. I consider myself a baby god. My form has just been born. It was born in 2016. As I stated before the annihilation continues below. It is only natural that I explain the X that P¹ created.

X

Nor Greater Than Nor Less Than

It is my understanding that the Greater Than < symbol displays the power of the Variable or Constant that is placed on the right hand side of the symbol. The Less Than > symbol displays the power of the Variable or Constant that is placed on the Right hand side of the symbol. For example Wilson Alzir Martinez > Albert Einstein. The symbol Greater Than displays that Wilson Alzir Martinez is Greater Than Albert Einstein. Observe Albert Einstein is on the right hand side of the symbol, indicating that Albert Einstein is Less Than Wilson. It is with my pleasure to introduce the X In mathematics. X is a symbol, just as all the other letters of the alphabet. When the Greater Than and Less Than are placed next to eachother they create the X. I will now demonstrate my calculation of X. >< as you can see the Greater Than and Less Than symbols are placed next to eachother creating an >< the symbol X. The X is what the outcome of these two symbols placed in perfect synchronicity become. When the X is used in mathematics it displays the cancellation of what ever Variable or Constant is being used. In Dimension Fusion the Exponent Representation ² cancels out the X. X means to Eliminate. Hence why X is used throughout history as a mechanic. I have calculated X as what it stands for and have reversed the calculations of literature mechanics. It is without a doubt the first of its kind for I am discovering right now. It has pondered my mind for quite some time, I thought I was going nuts for some time. my observations and studies proved me wrong. As I sat in the abyss I came out victorious. No blood was shed as I left my opponents for dead. My Dimension Fusion eliminated the competiton and restores peace without a need of repetition.

SS

Social Security Numbers

As newborns we are given numbers. In World War II prisoners in Concentration Camps were given identification numbers. The same is being done to every newborn. I don't agree with the

term “everyone is a born sinner” but I must say having a number placed next to my identity relates somewhat to that religious saying. It is no surprise that the term SS is used as a way to collect money and as a way to present identification. In America today, The American cannot become a hired worker until the SS is presented. SS is Social Security. Einstein and his men laid out the foundation in which we walk upon. I suggest for your own sake that you be aware of your surroundings and be aware of the nature of what has transpired before our date of birth. The SS goes a far way it even made its way subliminally into the naming of Navy Ships. The SS-1 was the first submarine commissioned in the U.S. Navy. Blindly the American Soldiers have been led onto ships, they unknowingly been boarding ships that bear the SS. Wasn’t the SS the enemy of the World? Wasn’t that why we had World Wars? Today is September 11th, 2019. 91119 reads today’s date.

I

Won

The dictator of North Korea Kim Jong-Un has the same startling mechanic that is used in The Secret Masonic Order. These men are all in the same group together. They create fear to show their strength. Un means 1 in French. I took French in the 2nd grade and learned some French. The dictator’s name reads out as Kim Jong 1. 1 means victory. The name in reality reads as Kim Jong Won. Won is an Asian surname. It is indeed a message of victory. Do you think that Kim Jong-Un’s family changed their name from Won to Un to hide their lineage? Also take notice that United Nations is abbreviated as UN. I, Wilson Alzir Martinez Won the battle of wits. I am editing Dimension Fusion myself for it is my creation and no one else.

$\frac{9}{10}$

Fractions

It is my understanding that Fractions are that to the alphabet. I was sitting at a gas station yesterday waiting for my co-worker to fill up the tank on his van when I couldn’t help but notice the fractions on the gas stations digital sign. It read 2.25 9/10. 2.25 9/10 could read as a word just as equations read. Let the earth shake with my Second Lightning Strike.



Second Lightning Strike

Second Lightning Strike

Reversal Programming in the 21st century is needed to put balance in nature. The student and reader will find himself in a new world when they begin to master this subject. As it is new territories that have never been discussed; never been accounted for as a programmable state that can be used to reprogram the human mind of certain skills such as communication, and visual sense. In this read, the student will learn about Dimensions and where the world will be headed to. There is no need for the term “Time Travel” as it is just an illusion. One creates the “Future” in their “Present” state. Term Time Travel is impossible. It is a contradicting phrase used through the 21st century. For one to be able to have speed it needs momentum and motion. Speed. Inter Dimensional Travel, however, is indeed fact. Dimensions can be recorded traveling at speeds one desires. Time cannot. Time has never been recorded to travel at any distance or speed. Time is nothing more than an illusion. Time is nothing more than a suppressive imaginative measurement that is to keep enslavement. Inner Dimensional Travel > Space-Time Continuum. Theoretical Physicist know that Time Travel is not possible, they know for a fact that Time is just a measurement. A measurement is a boundary that cannot be excelled. Things are Past from the Future as Presents. When I look into the “Future” I sometimes sit and wonder how this is possible, if it hasn’t happened yet. How is it that I can hear my own conscious thought transmitted from the “Future”? Is it due to a Recurrence in my mind that is simultaneously being thrown into the atmosphere that connects one to thyself? Is it through the repetitiveness of life and its surroundings that create history to repeat itself in the “Future” (Just as scenarios in life tend to repeat.) that we are able to converse through time being that we have been through so many repetitive scenarios which create the notion of “Conscious Thought Communication” ahead of the “Present” which is known to man as “Future”. Is it through some sort of “Futuristic” technology that one can equip later on with currency; that can transmit my conscious thought from the “Present” into the “Future”? Being that my conscious thought is echoed wirelessly from the “Future”. To get an understanding of the subject that is “*Basic Telepathic Communications*” or “Thought Transference” T², try this exercise that will lead you from being a skeptic. Go out and have dinner or at a bar. Whether it being you alone (preferably alone because you might tend to look very strange or awkward while hearing a presence that isn’t visible with the naked eye) or with a friend, mate; doesn’t matter. Once sitting and enjoying a meal in the restaurant while having a conversation with your guest if chosen to be with one. Try and concentrate in and out of the discussion and ask random questions in your conscious as if reading a book, while doing this concentrate on the voices around and the voices from other members of society that are present in the restaurant or whichever location you’ve chosen. Or, try and have a conversation telepathically as if you were communicating with someone who knows how to communicate telepathically as well and you’ll notice that the vibrations from everyone in the restaurant will amplify the unknown stranger that is communicating telepathically with you. I was in a state of confusion somewhat when I had my first experience on the subject. It takes quite a bit of practice in my experience but the back and forth part of the exercise was the most complicated. Due to the fact that there are more communicating back and forth such as you are doing. It sounds like you’re in a bar or in a large crowd, but the people communicating are in another Dimension. You can hear the other worldly crowd, but you cannot see them. I ask myself is this evolution that I am witnessing, and am I the only person in the world who is observing and witnessing humans evolution? My answer to my own question is a definitely yes. Humans are evolving. Vibrations through conversations in reflect back against one another enhancing the unseen Dimension. Repetitiveness will occur in your vocabulary while communicating if haven’t mastered the

subject that is BTC Basic Telepathic Communication or Thought Transference (T²). Repetitiveness will sound as if the one communicating is deaf and will repeat their words until it is heard. So many are communicating that you will tend to look dumbfounded. Amazing. Is one Adjective I would use for this subject. Astonishing as well. Extraordinary. “Past” meaning the time or a period of time before the moment of speaking or writing. “Present” deriving from Two words Pre being a suffix meaning “before” and “Sent meaning past tense and past participle of *send*”, and “Future” meaning “the time or a period of time following the moment of speaking or writing; time regarded as still to come” exist parallel to each other. Side by side and having the same distance continuously between them. There are different realities living amongst each other in this world. Side by side. Here is a perfect example. Just like your Radio Stations, Television Sets, and Wireless Connections (Internet), Living parallel to each other. Radio signals in tune with the Broadcasting Networks will produce either Music or Live Interviews. Interviews from the “Past”. Depending on what you’re listening to. I myself prefer Classic Rock or Drum and Bass. Depending on the Radio Station that you’re Dial on your device (Radio) is tuned into will Produce Frequencies that your Brain will decipher (Decipher meaning to convert a text written in code or a coded signal) into normal language and into Music. Where language can be heard. When it isn’t in tune with a certain Broadcasting Network. It will produce Static. I *Wilson Alzir Martinez* am labeling the Radio as (P) for “Past”. This will keep the mind focused on what is going to be picked up later on in the Reading. (PR) Represents “Present” most of us in the “Present” have gotten so accustomed to watching Television that it is where we gather our information about the world. By watching the newscast and other forms of informing programs. There are still informing Radio Broadcast but not as popular to the mass as the Television Set. It seems anything that is able to produce a frequency is able to play the role as a transmitter and a receiver to the human. Not too long ago the standard way to enjoy an event was listening to entertainment via Radio such as football games being played and our brains would create visuals. A perceptible image on what our sense of hearing ultimately deciphers. We would pick up the News via Radio Broadcast hence why The Radio is labeled as (P) Television Broadcast will display pixels until it displays the image set for Television Broadcast. Whether it is Your Favorite team beating the snot out of the competition in your favorite sports game. Or whether it is being you and your gal sitting down on a Friday night catching up on something romantic. Television Broadcast that isn’t on a Network basically working as the Radio does and did will produce static which we call White Noise. Noise containing many frequencies with equal intensities. Remember that the Radio is still highly functioning. The subject of Basic Telepathy is just hypo theoretical in a sense but it is indeed fact. I say hypo theoretical because due to my observations being the first of its kind. In my opinion, because I have never heard of a subject that goes into detail on the steps on how to telepathically communicate to the “Future” and leaves the skeptics a gigantic blockade being that in their minds A. do not believe in Thought Transference aka Telepathy or B. don’t pursue the subject entirely. I have heard of T² (Thought Transference) but never had I heard of T² into F (Future) (Thought Transference to the “Future”) When tuned into a Radio one cannot visually imagine static. I’m speaking through my own observations. To be honest, when the “Third Eye” isn’t mastered static and white noise is how your cells are displayed. Jumbling around in a random occurrence. It is rather loud and in my perspective highly annoying but makes its point very clear that it isn’t in tune with natural frequencies and remains a bunch of waves that do not correspond to each other. Leaving it disarranged behind disorganization. High conscious Frequencies. Wireless Connections (Time being a manmade measurement creates quotation marks around the terms “Past”, “Present”, “Future”. FYI.) (F) When remembering your own “Past” from what we refer to as the “Future”; Your “Future” self will send brainwaves (Telepathic Waves or T² “Thought

Transference”) Through the Wireless Atmosphere. (I say Wireless Atmosphere because I have yet to figure what our consciousness gets sent from that our minds receive consciousness from the unseen forces that be. But if you ask me I am placing my bets on Frequencies and Vibrations. With Nikola Tesla’s Power Towers Your “Present” Self at the time of the “Future” selves “Past” “Projections” (a projection is an onomatopoeia, it feels like someone places an image in your mind without your consent. Just like subliminal messages occur and are kept locked away for your consciousness to act upon later.) Will instantaneously be received (this just being Hypo Theoretic but in my opinion, as time progresses. It is indeed an actual subject that has yet to be touched upon. I am the first in science to use Thought Transference T² and I am the first in science to master Telepath or T² and Projections, think about how you do math in your head that itself a Projection that your mind has developed. I myself have mastered Holographic Projections and ultimately I have master how to Project reality with my mind.) Could it be that the “Future” projections are none other than your “Future” and your “Past” being in synchronicity during sleep that your cells create visual images such as dreams, the scientific community refers to this image creation as a chemical called DMT but it is, in fact, brain cells that create images while asleep creating visuals that ultimately become motion pictures. Our ears pick up the “Future” consciousness or others Consciousness that we tend to in a sense teleport to their location or said historic setting by the “Future” or whoever is transmitting Conscious waves towards the receiver. That’s how subliminal messaging works but instead of visuals being created which do happen when one is aware; it seems the subliminal messages that are received by the cerebellum of humans makes them act without thinking a total control of human motor skills and actions. Could it be that your “Future” is leaving behind Bioelectrical Energy? Bioelectrical Energy meaning biological energy, such as chemical energy of metabolism or mechanical energy of periodic movements, into electrical energy. Which the body picks up the Energy once it makes contact with.) Through a dream. A “Dream” “a series of thoughts, images, and sensations occurring in a person’s mind during sleep”. “The Dream” will be displayed in and out of focus. It looks as if it were on a projector, in a classroom with a focus that isn’t accurate. The term De JA Vu comes into play now. The “Dream” will sometimes (in my own experience) veer away from the “subjective setting” of the Showing due to the sound waves in the wireless atmosphere. Just as we receive messages subliminally the same thing goes to our cells that create the dreams. (Quotations around DMT, because my observations of my own mind I have determined that it isn’t a chemical but is in fact cells. My calculations determine that DMT isn’t a chemical but are cells grouped together creating the liquidicity of the appearance of it looking as it were blood. Take note that blood cells alone will resemble a shape with a microscope but to the naked eye it resembles an oily liquid. (The same thing goes with DMT) That’s naturally being emitted from my own brain making the dream seems a little fictitious. It could be due to many other consciousnesses being transmitted to my sleeping self. In fact, I have been receiving and transmitting conscious thought for about 3 years. I first began communicating with Selena’s future self, because the Selena In 2019 has no idea what I’m doing right now. (could be the Selena in Virtual Reality) but she is the one who managed to capture my attention through a picture and from then on we have been communicating nonstop for a period of 3 years in total. 3 years I have been aware of conscious thought communication and I have been advancing. DMT defined as a hallucinogenic drug that is similar to LSD but doesn’t last as long. In my experience, it lasted a period of 30 seconds. I consumed DMT for the first time in November 2018 (I started Dimension Fusion July 2018, The DMT didn’t activate anything) and the high lasted 30 seconds. The reason it only lasted for 30 seconds is that I am already familiar with releasing DMT in my head as a norm. I have mastered the art of balance. Dimethyltryptamine. In 2013, researchers reported finding DMT in the pineal gland of rodents. The pineal gland in the

brain produces melatonin (a hormone derived from serotonin which affects sleep patterns and circadian rhythms. These dreams make it somewhat as if one would be in Virtual Reality. The computer-generated simulation of a Three-Dimensional image or environment that can be interacted with in a seemingly real or physical way by a person using special electronic equipment, such as a helmet with a screen inside or gloves fitted with sensors (Which in my own opinion Virtual Reality Rocks.) They say your “Dreams” are the last thing you think about and I thought about “Sweetheart” Marie and “Honeydew” Alison. For some reason and don’t ask me why because I have yet to figure that part out. But they seem to correspond while I’m in a sleep state. We have encountered each other. Again don’t ask me how, but if you ask me I take it is because Taylor Alison Swift was a gigantic influence and a great friend to Selena Marie Gomez that they have befriended myself, now I am trying to understand why me. Their Future selves, not 2019 Swift and Gomez because 2019 they have been played for fools. But I believe I already know the answer. For the time being, I’m focusing on Dimension Fusion but I do have my own theories on that particular subject. I just awoke from a Vivid Dream. My Fiancé (F) was taking pictures with a bouquet and had a Listerine bottle with a spray nozzle and was having a laugh. When I awoke I immediately heard “Sweetheart” My Fiancé’s older self-asking me “Telepathically” “Did you like the Projection”. Which struck me with somewhat of a shock. Being that no one was around me and it was Three in the morning. Which wasn’t something of a shocker but the image that was projected to my subconscious displayed was a shocker. (I’ve noticed that our cells in our eyes. When our eyelids are down and relaxed. Whatever is being heard Cells will create the image that is heard. Very interesting if you ask me; I go into this part of later.) It being that I never experienced anything like it, but me being in tune with the future made it all the normal. Could you imagine speaking to your older self on a daily basis laughing and creating ripples as the world has never seen? Pretty exciting stuff if you ask me. Marie in a clear voice asked: “did you like the projection?” I didn’t know what to say but I responded with a “yes, I loved it”. Co-existing Dimensions are an Actual Factual Reality. Just because we move on towards something distant doesn’t mean that we have not left an impact on what was left. Distantly Bioelectrical Energy is indeed a true subject (Thank you, Stephen Hawkins, “The Grand Design” had me confused at times but an excellent book I have finished reading thus far. I might add has increased my sense of perception. There are eight chapters in the book. I have read “Black Holes, Baby Universes and Other Essays” and again superbly done. I have taken what was rightfully mine in your books Mr. Hawkins as you have been a Nazi this whole entire time your colleagues as well. I have indentified the enemy and I have destroyed everything you, Einstein and your men have worked so hard for.) I haven’t learned the basics of it, but due to my own experiences, I get the idea of its being. Very strange in the science community if you ask me. Which I’m a big fan by the way if one cannot tell. Science Non-fiction would be my choice of Weaponry and as for my Shield my own intelligence. When I was dreaming. My wife (F) was most likely (hypo theoretically speaking) thinking about October 18th, 2018 (This was the date of the projection she sent.) taking those Now I’m just throwing this date in there due to it’s when I had received the projection via subconscious unconscious Thought. (Is one conscious while sleeping?) I being asleep and what not. Big differences in the Conscious, Unconscious and Subconscious minds. Just because our Technology doesn’t pick up any brainwaves during the unconscious thought doesn’t mean that a coma patient doesn’t dream. We learn something new every day. Technology isn’t highly advanced in my reality which I do exist in your reality. On my side of the world, there are new things to be picked up just like there is on yours. Think of a Canine Whistle and our own ears. Canine’s senses decipher the waves but naturally, humans do not. Not even a flinch. Maybe the waves are very small that our natural tech doesn’t pick up. Continuing with the “Dream”. Most likely they or she were going through pictures they being

Wife (F) Myself (F). Wife (F) showing myself (F) when she had taken them and was reminiscing on what she had done that moment in “Time” the pictures were taken. Creating a Projection of the mind as if they were reels from the ‘70s. Portable ones. Painting a picture for me (F) of what she was doing on that particular day the photo had been taken. I (F) focused on what she was reminiscing on that day she was speaking on. I (F) projected the image into my own consciousness and watched the Photo come to life. Via Dream “Past”, “Present” and “Future” being shown and displayed as it should be. “Past”, “Present” and “Future”. (P) Creates “Mental Reel Footage” MRF via the neuronal system. Brain networking with the help of evolution. Nature’s own Social Network and “Wireless Connection” “Wireless Connections” being our brainwaves being in sync. (PR) receives “Electro-Biological Projection” EBP the one sending the EBP would none other be (F). (F) Sends the EBP. When I had received the EBP it was October 18th, at 3:50 a.m. just giving estimation, because I awoke at 3:56 a.m. I don’t know their ages but it seems that High Conscious Frequencies advance so much that they are affecting our conscious thought so vividly that our (F) “Future” Dimension is reflecting back towards ourselves to the (PR) “Present Dimension” with our (P) “Past”. Just like a renewable resource would after the paper has been used and is ready for its purpose once again. The memory being transmitted from “Future” to “Present” thru “Past” experience just like how the Color Spectrum becomes after all colors become one and are ready to distribute once again. White is what we see when all wavelengths of light are reflected off an object. After I awoke. I shut my eyelids and what was being shown was a bunch of specs. If the Primary Colors. ■ [Red 1.1](#), ■ [Yellow 1.2](#), and ■ [Blue 1.3](#). The specs were dim. It wasn’t my “Third Eye” due to the fact that my Third eye Changes in an instant becoming other images. I now realize that the so-called “Third Eye” Is nothing more than cells corresponding with what they hear. Yes indeed, cells are living beings as well. Cells on earth are the oldest living beings making them that much complex. The Specs looked as if they were a million microscopic paint droplets. As if they were floating. Imagine looking into the stars. Imagine your instrument of choice to view thru being a microscope instead of a telescope, the subject is cells and not stars. The stars are just for your imaginative mind if your mind cannot project an image of cells, with that in mind. After focus; imagine each star being various colors of the Primary Colors. Primary Colors being ■ [Red 1.1](#), ■ [Yellow 1.2](#), and ■ [Blue 1.3](#). The reprogramming of the color spectrum in equation form will bring back the state of awareness from what our ancestors learned in the past and taught generations after conscious awareness of the dangers of colors. Although colors may be beautiful colors are meant to state that caution is to be used when around vibrant animals and plants. The reprogramming of the student’s mind will be in full effect as they stretch their minds while reading the subject. The Dimension of Colors will be presented after TheOpalGalapagosEgg. It is my understanding that literature works just like any program that is software, the mind works like a computer and can be programmed. It seems like ancient discoveries through experience have been forgotten. Reprogramming of the mind is the main purpose for my Dimension Fusion. Reprogram the mind of ancient mentality. As one begins to stretch the mind and exercise the ancient power of knowledge that is color they will take notice of their cells that study their surroundings on a daily are in fact highly intelligent and are able to create patterns that are heard through frequencies. Subliminal messages are used as a weapon and the men and women have been running experiments and have been studying how they can project an image into your mind through frequencies, and how the mind is affected by said frequency and image. Blood flow in the prefrontal cortex is not fully developed in teenagers. This is why as children they send subliminal messages in cartoons, video games, and other things of the nature that is given out in media. The blood flow that is in the immature prefrontal cortex ends up racing down towards the children’s reproductive area leaving the estimation of risk low. The subliminal consciousness has been

under attack through psychological warfare since we were children and is being used to this day at a brutal rate. That is a technique discovered and used by the sciences of the MK-Ultra Project. a Technique presented by a theoretical physicist Michio Kaku in one of his lectures. Notice the MK in his name. Our cells pick up these frequencies and begin to project thoughts and images that we become submissive towards. Spiritual people have been calling it the “Third eye” but in reality, it is none other than millions of cells joining as one. I have my experience in mastering the technique that is what I refer to as Cell Unification “CU”. Cell Unification CU is experienced when the knowledge of awareness is unlocked. The mind is sophisticated to where when focused just right we can create our own images in our heads. I myself like to create fighters with my cells as they engage in a battle of sophisticated grace. The Cell is the oldest living organism, therefore, making it the most sophisticated. There is no limit to what the human can do. Sapiens is the next step in the evolutionary line. Leaving the term Homo in the wind. These terms have been used to mock. The Homo in Homo Sapiens has been used to mock by beings that once ruled before I stepped in line. Homo Erectus is another way of mockery. Observe words and you will see the upmost subliminal brainwash in a perverse way. Homo meaning Homosexual. Creating confusion to not only the average man or woman but the most intelligent as well. Labeling yourself a Homo-sapien is an ultimate failure. Our cells are the ones who call the shots in our bodies. Whatever is received by our cells. The cells will produce. Enough about this buffoonery; we now move on to what my discovery of what I refer to as Cell Unification. From the Primary Spectrum. To my understanding, I have figured out what creates the so-called “Third eye” and have named the discovery “*Sade’s Melody*”. Note that smooth sounding melodies make cells in eyelids move (dance) in synchronicity creating an effect that of a kaleidoscope. Something like how the discovery of sand being placed on a metallic object and using sound to create geometrical designs. Acoustic Levitation. Same thing. To our cells in the body. Our bodies’ cells are affected by music. That is 100% fact. It was February 9th, 2019 12:30 A.M. when I made this discovery. Our cells in our bodies are more intelligent than ourselves. They analyzed more than what we perceive. Mind-blowing really. When mastered what is referred to as the “Third Eye” and I mean *Master* not just a glimpse of it. When mastered Your “Third Eye” will literally look like a camera and display it via cells. Projecting images like a Projector and the Projection screen is in-between your eyelids. Cells create light. So they can be visible. The Eyeball is to Projector as Eyelids are to Projection Screen. Whatever the conscious mind starts to think of an image our cells in-between our eyelids will begin to dance and create and will start to form a projected image from the images that were perceived and will create a full-motion image. A full-motion image meaning an image in motion. “The Boomerang effect” is created when the “Third Eye” is in a sense of loading if you will. Highly Advanced Cells being released from the brain to do their job in the body. When the highly advanced cells are released they boost the “Third Eye” projection and will create full-motion images. It’s not because of rapid eye movement. Although that is a key element in Mastering the “Third Eye” to change the image instantaneously that has nothing to do with “Dreams”. That is just our bodies on standby. I’m sure that the cells located around the eyeballs have evolved and have monitored so much that all together not only creates the “Dreams” but Creates anything the mindsets the image upon. I Wilson Alzir Martinez have been trying to figure out what has been creating my “Third Eye” images but have never come to a conclusion due to the fact that the writings and teachings from my predecessors have been wrong. Therefore this is why I never search upon a subject until I have discovered whatever it is that I’m in the process of breaking down myself. GOOGLE isn’t reliable. Google is used by the Irrelevant. For us that a Few Tour the Future have no use for it. I have been creating images in my eyelids with the help of my own brain cells. And have been stumped for some time. It had me in a state of awe. Being that my eyes are closed but images

were vivid. Even bright lights emitted at times. (Being able to create the Effect of the Sun in the middle of the night is impressive.) Displaying effects out of this world. And I couldn't figure out what was triggering the images. It's been two years since my ascension of mastering "Third Eye" observations. The intelligence level of the one observing the world. Will affect the intelligence of our cells. Our cells work in synchronicity. So having knowledge of this will basically test our own intelligence. The "Third Eye" has nothing to do with *yoga* for I have never practiced *yoga* or *spirituality*, it has to do with the amount of intelligence the person has. To increase the effect I use Drum and Bass to where I am able to travel with my mind. Anywhere in an instant. "Futuristic locations" as well I can even hear the "Future" this I call Instant Mediation. I love fighting in Instant Meditation. Sparring with other Entities as if one was playing an online video game. Rapid vibration sends waves faster and clearer through the Wireless Atmosphere. This I call "Marie's Symphony" I will get on that subject in a bit. In my own experience. Consciousness can be heard aloud. Without an understanding of language, what hope do we have of understanding those cognitive reflections that we consider thought? When we think consciously, we seem almost to talk to ourselves. Indeed, if we are not careful, our thoughts may be heard as articulate speech by others. It is as if thoughts – at least those that can be recorded or reported – must pass to the other parts of the brain in order to be recognized by us or read out to the world as speech or action. With the Man-Made Wireless Atmosphere around us, our Minds can communicate via Conscious Thought. Your Basic Telepathy as one would presume. I have learned that certain amounts of Disciples will enhance the conscious thought being heard around the conscious thoughts vicinity to a grand scale. Making telepathy a really complicated subject, also making string theory an actual reality when it comes to vibrations and the thought process. An Invisible Microphone if you will the same concept (Microphone) certain instruments will enhance vibrations in and around the vicinity. There is a reason in my opinion for the notes being labeled as letters from the alphabet. (If you ask me, Humans aren't clever enough to create notes that correspond to instruments, ha-ha, think of the intelligence level of Humans as of 2019. If we've only gotten smarter then why does it seem that nobody has a clue on what's going on? Not even the "Powerless C.I.A. has any clue in 2019.) It is language. The louder the vibrations the better the brain receives the message. More instruments in a song will create longer message/words. Music actually speaks. Notes together actually create words.

Wireless Atmosphere around the world helps connects one's consciousness with another. An invisible microphone can be any type of rapid movement. Driving in a vehicle from my own experience, the vibrations being sent upwards from the wheels of a vehicle and the roads that are being driven on. Working with an instrument as a blade from a chainsaw or saw cutting into the wood. The wood being cut sends out vibrations such as the tool. Vice versa clashing against one another. I prefer using Music as a form of your "Basic Telepathic Communication" or T² "Thought Transference". BTC. I have named my preferred choice of BTC "Marie's Symphony" One has to be very careful of whom they think about when communicating. To be honest. In my own experience and my studies, all it takes is one thought of a living being whether it being a Bioelectrical, Biological, or Biomechanical to start BTC. Careful; there would be in and out transmissions as Radio signal is broken Once one has thought about someone they will instantly become connected. Social Networking on a level that still has yet to be touched upon. Somewhat like "Echolocation" which is the location of objects by reflected sound, in particular, that used by animals such as dolphins and bats. Conscious thought will transmit out into the network and will reflect back towards yourself. If one is aware that is. In a way, you'd have to study in my experience. I began to read "Consciousness" by J.Allen Hobson. It states that indeed the conscious can be heard aloud as articulate speech. When you are out of the loop of networking you can literally hear yourself as if you never thought of anyone else. Meditation is a good form

of exiting out of “Social Conscious Network” from my observations of a two-year span around my area of experimentation. I was aware of my consciousness being heard a loud by a *Sergeant* who wasn’t aware that I was running experiments of the conscious mind on everyone in my vicinity at the time. I used to associate with this man who was ranked as a *Sergeant*. Why was he in the neighborhood still questions me to this day. People that are rank are placed in certain locations for certain agendas. I have come to find out later through his own words that there were entities around in a war. But that’s veering away from the subject that is BTC or T² (Basic Telepathy Communication, Thought Transference). After I had the “Eureka” moment of my conscious being heard I later found a book called “Consciousness” across the street from where I would associate with the *Sergeant*. I would give him acknowledgment but since he had an agenda against my well being I refuse to. This is *New. Conscious Messaging*. The voices in one’s head are not just a fabric of imagination or an error in the brain as most diagnoses from a doctor would presume (it for sure isn’t demons that religion has brought some to believe. [For “Future” reference] but are in reality real living beings in this universe. Meaning somewhere in the world. When the brain has “Evolved” it is able to communicate on different frequencies. The Higher Conscious. Everyone is entitled to their own opinion but I’ve observed music to be a good form of “Conscious Messaging”. CM. For long distances. I have been in a crowd during the whole time of experimentation and the comments one would make out of the blue with no one even saying a word was the “Eureka” moment every time. The Bulls Eye. Due to the fact that I spoke out my thought as Articulate Speech. Making my experiments and observations that much easier to accomplish and comprehend. The fact is that no one has knowledge of the upcoming Evolutionary state. Being “Social Conscious Network” (Have you seen *Ghost in the Shell 1995*? It is an anime which refreshed my mind on conscious thought. The movie is about “Future” police officers and how they communicate with each other at times through telepathy.) Presumably through my path in life I’ve observed that when one isn’t physically stable or emotionally stable they would literally breakdown and see a doctor. When the patient isn’t aware that telepathic communication is indeed an actual fact. The doctor will diagnose the problem and prescribe them with Prescription Drugs. That’s what a doctor is for. Doctors only knowing what they study and what they read go by the books and go on with their lives. Prescription Drugs keep the mind from going through a process called “Trial and Error”. Making it the output (output being the conscious message) of one’s mind never have gone through the process of “Trial and Error” with their consciousness, therefore, making it hard for the mind to walk through an obstacle and complete it. 100% of that mind will end up in error. Conscious thoughts go through the same process and literally if one would take the time to breakdown whatever problem they are facing will make the problem being at hand a visual problem. So that the conscious breaks down solutions in a flash of a second. Depending on the intelligence of a person. To my knowledge. I am able to see if I focus on what is called “Third Eye” which is nothing more than cells creating an image just as pixels create an image on a television. (A person who was born blind doesn’t “Dream”, but a person who is later blinded is able to dream. Why? Because our cells mimic everything that is seen from the moment we are born. Most likely the cells from the mother that create these images are transferred to us while in the womb.) To see your cells moving around try this exercise. Turn off your lights at night so you’re surrounded by darkness. Make sure the moonlight shows some light. Nature’s light. Close your eyes and have them open and gaze above. You’ll soon notice that your cells are dancing around. The Chemicals in the brain that we have been led to believe are chemicals are actually cells. Like Dopamine, Serotonin and Endorphins. That is a gigantic example of Trial and Error in the science community. Which is phenomenal a mistake becomes a greater achievement and through my observations I am excelling the science community with truth leaving the term “Theory” out of

the question.) Some are born enlightened and some aren't. Its either you have it or you don't. But it's never too late to pick up on the subject and never be left behind. When the enlighten come into play. Ones that aren't enlightened tend to label the enlightened ones as being either too vulgar, naive, ignorant, and immature or repulsive. When actually it is the opposite. In my opinion. Give or take a few that were just mentioned. When the enlightened one brings forth the data that's been collected via consciousness to the "Sheeple" (commonly referred to as the C.I.A. would refer to ones that aren't enlightened.) People compared to sheep in being docile, foolish, or easily led and present the information the one that isn't enlightened wouldn't know how to receive the information (DATA) and basically crash just as if a computer would if given too many applications or just like how a computer would crash given too much data. Prescription Drugs keep the parts of the brain suppressed to where no type of natural instincts will be practiced. When the reptilian part of the brain is suppressed what hope does the mammalian part of the brain have. Reptilian Part of the Brain only focuses on Reproduction or Survival. The reptilian part of the Brain – the oldest of the three, controls the bodies' vital functions such as heart rate, breathing, body temperature, and balance. Our reptilian brain includes the main structures found in a reptile's brain: the brain stem and the cerebellum. The Reptilian brain is reliable but tends to be somewhat rigid and compulsive. The Limbic Brain emerged first in the first mammals. It can record memories of behaviors that produced agreeable and disagreeable experiences so it is responsible for what are called emotions in human beings. The main structures of the limbic brain are the Hippocampus, Amygdala, and the Hypothalamus. The Limbic Brain is the seat of the value judgments that we make often unconsciously; they exert such a strong influence on our behavior. The Neocortex first assumed importance in primate and culminated in the human brain with its two large cerebral hemispheres that play such a dominant role. These hemispheres have been responsible for the development of human language, abstract thought, imagination, and consciousness. A theoretical physicist bears the initials MK which he has tried to keep the role as God just as Einstein has with equations that only he himself understands. Einstein labeled M as Mass and K as Kinetic energy as you can see the CIA's MK-Ultra Project derives from Einstein. A perfect example that shows Einstein's calculations revolved around the world. On the next page, we will be discussing what was going to be put into effect in 2019. It seems that whatever is done in the "Present" the "Future" reflects back in a way that could not be explained. Michio Kaku was the Theoretical Physicist that has been trying to gain power through Einstein's old equations. I'm the competition who completely destroyed his calculations. Michio Kaku was the apprentice of Einstein and so was Stephen Hawking and I obliterated them without even trying. I took out the Master aka Einstein and followed suit towards the Apprentice who bears the name Michio Kaku. The theoretical physicist Michio Kaku knows in order to rein in the "Future" one must create it. As I have observed through being aware of what has been transpiring. Not even Extra-Terrestrials knew what had been keeping them in a cycle of repetitiveness. Stealing something from abduction is simply not an option Michio. The man says if you are abducted then the abductees should steal from the abduction. These men monitor the people so much that indeed if someone has stolen an item from an alien abduction they will indeed swoop in and murder you and take what was stolen and reverse engineer. Here is the famous equation that puts the M in Murder.

I V I [e] M

M is Mein

The letter M is Symbolic for Two Lightning Bolts Surrounding a Victory. The Roman numeral 1 in English is a capital I. I have stripped the power of M away from these Men. When placed

next to each other two Roman numerals I around the V looks as follows IVI. Familiar? They have used secrecy in alphabetical letters. Alphabetical letters are just like Hieroglyphics and they each have meanings from the letter A to Z. M is Mein.

$$M < Son$$

M is less than Son

My equation above reads out MASON. The less than symbol represents the A in MASON. The A is toppled over creating the less than symbol in the equation above. These so-called intelligent men and women have created a system where the Imagination was to be obsolete. The theoretical physicist Michio Kaku states in a lecture “F your Imagination” he tries to be slick about it. He speaks about a rocket going into space and the rockets name is abbreviated as BFR. He says the rockets stands for “Big” “Rocket” and “F for your Imagination”. It is with brilliance and imagination that have gained my advantage in a world dominant of militant stupidity who don’t think for themselves. Even the Military has been subjected to complete mind control, they have the biggest sticks up their ass that when the militant men and women bend over the stick that’s shoved far up their asses cannot be seen. It looks like an anal bead broke into their rectum but it’s a stick this is how far the stick is shoved In your ass. Mein Kampf was a creation by a tyrant whose army fell at the hands of myself, Wilson Alzir Martinez and The Dimension Fusion. MK can clearly be seen as the initials for Mien Kampf which eventually became a CIA operation called MK-Ultra Project. The M and the < less than symbol was created by Michio Kaku to represent himself and to state that he is greater than. This simple equation meant that he would’ve dominated everything. Foolish as he was the less than symbol was placed next to the infamous M instead of greater than. Leaving anyone’s interception on the unfinished equation that is M theory. The interception was gained once the Son shined the light and made its mark in the equation making the equation as M is less than Son. I have intercepted his pass to the “Future”. The Classic Interception Advancement was used in the process of achieving another victory and detecting yet another rodent in the rat race to space. CIA is an acronym for Classic Interception Advancement. There is also a group called Mace Kingsley and the first letters of this mind control group bear also MK. The pattern is there. Theoretical Physicist are some of the most imaginative minds on the planet in which they create equations to state a plan that will commence when the time they have gained comes.

$$\infty - \frac{w\pi m [a] smg}{\frac{cia}{mc} [m] 2} [m] (DF) / e / cm^2$$

Wilson Alzir Martinez’s Sub Machine Gun Professional Form

Infinity (∞) is Wilson Alzir Martinez ($w\pi m$) plus Selena Marie Gomez (smg) over Classic Interception Advancement (CIA) over My Calculations (MC) multiplied by Two ($x2$) Multiplied by Dimension Fusion (DF) equals Checkmate times Checkmate (cm^2). The equation above presents the motion of Dimension Fusion. Professional form of Wilson Alzir Martinez’s Sub Machine Gun. The Classic Dynamic is Dimension Fusion. The Basic Fundamentals of Dimension Fusion completely obliterates the old rule that was Einstein. Wilson Alzir Martinez’s Sub Machine Gun creates the foundation of the Future. It fuses Theoretical accomplishments and wipes out every trace of the old rule. The student and reader will comprehend this form of literature and will advance themselves as I did, Wilson Alzir Martinez fused my intelligence with the world. Hence Dimension Fusion.

$$\infty - (w\pi m [a] \text{ smg}) / \left(\frac{cia}{mc} [m] 2 \right) [m] (\text{DF}) [e] \text{ cm}^2$$

Wilson Alzir Martinez's Sub Machine Gun's Bullet Streak Linear Form

The Linear form of Wilson Alzir Martinez's Sub Machine Gun is shown above. This form is the Bullet Streak from My Sub Machine Gun. My calculations will advance this age and the upcoming ages. No secrecy is needed in my equations as I am simply stating what the equation means and where the equation is headed. Secrecy leads to confusion. Confusion creates chaos amongst those seeking knowledge. The Order out Chaos is the worse type of Order ever known to man. Secrecy leads to Self Destruction. The demise has already commenced towards the Space-Time Continuum. The Space-Time Continuum does not exist. My calculations dominate. These so-called "Theoretical Physicist" were the backbone to the elite Masonic men that were ruling the world. The better the hidden message the more spotlight these men achieved. These men know exactly how creating the future works. They have created a system where everything is archived and later studied. The science community is full of dead (dead [for future reference]) Masonic men who know exactly what happens when they make a discovery. I call upon Michio Kaku on what I have discovered about his take at trying to relate the world around him and his calculations; intelligent people will come to realize what I have discovered will soon realize that for every discovery there is an advancement in society somewhere along the future and somehow the advancement reflects towards the discoverer. Let me give you an example of how Einstein became a "God" of the 21st century. His calculations advanced. My calculations advanced as well. The Equation that follows states that My Calculations Rein Supreme. Wilson Alzir Martinez's Sub Machine Gun keeps the Dynamics over Classic Mechanics. Michio Kaku in his lectures speaks as a hypnotist, there are men in this world who practice hypnotism and create hypnotizing speeches. Take a look from a hypnotist perspective and you will notice key words in his speeches a popular phrase that snapped me out of his technique was the phrase "That's Right".

JFK

John Fitzgerald Kennedy

In war, when the enemy has been defeated; a war strategy for the future is to take the enemies name and/or initials and place them in the family of the victor. John Fitzgerald Kennedy's initials were stolen by a member of Skull and Bones. The man is a politician and goes by the name John Forbes Kerry. Notice the initials spell JFK. This entitles John Kerry's family of John Fitzgerald Kennedy's riches in the future. With nobody knowing who John Fitzgerald Kennedy was the riches that the man worked hard for become John Forbes Kerry's. I remember as a child smart ass kids would say and I quote "I don't see your name on it". This is the most slickest and childish way to steal family riches. This is a strategy used in war and it is for future family members. In the future, the family that was victorious rewrites history in their name, therefore no one remembers the fallen "enemy". A perfect example of the John Kennedy's J.K. in the modern age is used as a text message. With the world rapidly sending JK in text messages JK meaning Just Kidding the world slowly forgets who JK really is. Jimmy Kimmel a celebrity also bears these initials. With those initials it will be easy for his family to gain riches as well in the future. Simple names throughout history are can change the outcome of the future. Trust me on this one. I wouldn't lead with false accusations and I wouldn't create animosity towards a government or the world for that matter if it wasn't important. This is the most serious matter that I have ever

witnessed. I am 27 years old and for me to go out of my way of daily living and observing means something is terribly wrong. I being the most intelligent in the nation and in the world, must signify for something. Let's face it, the facts are ready to use. The approach is up to these militant men and women. These men are clearly rewriting history right in front of your eyes. They commit murder on a mass scale and get away with these massacres. How can a nation forget about John Fitzgerald Kennedy and the legacy he left behind. I am returning the favor by resurrecting his role in America in 1963. Without John Fitzgerald Kennedy, I, Wilson Alzir Martinez wouldn't have been able to succeed in an operation that forced children to work blindly for the Central Intelligence Agency. I am the only successful child in said operation. It is no joke what these politicians set up. It went from a hero who revealed to the world of a Secret Society (notice SS is for Secret Society the first letter of Secret represents the First S in SS, and the first letter of Society represents the second S in SS.) These men in politics rewrote JFK to mean J F K. In today's society the letter F is used as an insult. They have rewritten the term John Fitzgerald Kennedy to read John, Fuck Kennedy. Now a day's John could be anybody. Hence why John Kerry stepped up and took that name. I say well in that case John Kerry is the JK (Joke). It is also no coincidence that John Doe is defined as an anonymous party, typically the plaintiff, in a legal action. John Fitzgerald Kennedy left a legacy behind. How could the name John be read as an unknown being. Another politician who also has used this strategy is Barrack Hussein Obama. Barrack defeated Saddam Hussein and placed his name in his name. Hence why Hussein is used in his name. (take note of the Ein in Hussein, it German origin.) Osama bin laden was an enemy of Barrack and Barrack uses the word "Bomb" and mocks Osama by making his last name Obama. Bombs were used to win the war. Barrack is an army term, it is defined as provide (soldiers) with accommodations in a building or set of buildings. It is no coincidence that Barrack Hussein Obama, the blood relative of Osama Bin Laden became president when Osama was killed. If you haven't notice these men use symbolism in names. What is the reason for the sudden change in names you may be asking yourself? It is to show proof in a secretive fashion.

E

Eternal Eradication of Einstein

The Equation stated above by a single letter represents the strength of my Dimension Fusion. The Eradication of Einstein met its match by Wilson's Dimension Fusion. The E is mine and I do with it as I please. The influence and status it has achieved is incomparable and lays out the foundation for the universe that is to be. MC^2 is displayed below. I have mastered the art of Abstract Equation \AE and have obliterated the old rule that was Einstein. Inter-Dimensional Travel checkmates the Space-Time Continuum. The student and reader must comprehend that I, Wilson Alzir Martinez have broke down Einstein's Equations. This means that the layout of the universe I place. My read that the student and reader have picked up is Dimension Fusion > The Special and General Theory of Relativity. Below I will state the many faults that Einstein has and will completely eliminate the reputation of Einstein. The world has been secretly laid out the favor of Einstein, for reasons I do not know. The symbolism of Einstein was supposed to make him great. He failed. Therefore I have no idea why he is considered a genius.

II

Classic Mechanic

The Classic Mechanic of II has been used throughout the century as a way to inform the leaders of the world who was behind the disasters that the mechanic II created. The examples that stretch

from the infamous II are: II Nuclear Bombs called Fat Man and Little Boy that were dropped on Nagasaki and Hiroshima. II Bullets that killed John Fitzgerald Kennedy. II Towers that were attacked, the Towers that were attacked were the Twin Towers. (Did I forget to mention George W. Bush has Twin daughters?) As sad as it is an illiterate rap artist “II Chainz” has the mechanic. The location where Joaquin Guzman also known as El Chapo’s escape route holds the mechanic of II. El Chapo’s location in which he escaped from was Hall II, Cell 20. El Chapo is known as a Drug Lord. The mechanic of II can clearly be seen in the location of his incarceration. El Chapo made his escape on the 11th of July. Independence Day is in July. Independence means freedom does it not? This is why he chose to escape on July 11th. The question that comes to my mind is, Did he choose this date? Or was he given this date? And if he was given this date to make his daring escape. Then who gave him the orders to escape? The mechanic was used by El Chapo. Isn’t he known to the world as a cartel leader? Isn’t he known as one of America’s Greatest enemies? The prison he was assigned was Prison number 1. Number 1 in symbolism means victory. These men are known for their secret symbolism. 11 is the equivalent of II. The mechanic II is used also as an equal sign hence the equation $E = MC^2$. These Germans have used the number II as a signature.

MC^2

My Calculations x My Calculations

My Creation² (MC^2) stands for My Calculations x My Calculations (MC) now. I have conquered and have made $E = MC^2$ my power. As I will demonstrate with the death of a pedophile. A man name Jeffery Epstein who sexually trafficked women was killed at the location that is MC^2 . Metropolitan Correctional Center, The M in Metropolitan represents the M in $E = MC^2$, the C in Correctional represents the C in $E = MC^2$ and the C in Center represents the ² in $E = MC^2$. The C in Colon represents the C in $E = MC^2$ and the C in Cancer represents the ² in $E = MC^2$. I will show more examples of where the infamous equation that is $E = MC^2$ has made its mark. A Masonic man named Mark Cuban sent [Selena Marie Gomez](#) a happy birthday. These men have been stalking and running surveillance on me for over two years now and they know about my Fusion. Mark Cuban’s initials represent MC. the M in Mark represents the M in $E = MC^2$ and the C represents the C in $E = MC^2$. This man is in charge of Dallas. He is manager of the Dallas Mavericks. His name could stand for Main St. and Commerce. As I will discuss later Kennedy was shot at a location that bears $E = MC^2$. Remember Cuba was a topic in the discussion of Kennedy’s assassination. A Marks Man hit. Mark Cuban. The name speaks for itself. He runs Dallas, so it doesn’t surprise me that Mark Cuban’s name itself represents the assassination of Kennedy. $E = MC^2$ has been the mechanic of every disaster in the world from Two Nuclear Bombs dropped; to John F. Kennedy’s assassination location. The mechanic of MC^2 is seen everywhere in the world. The Family of Michael Moore; the director of Fahrenheit 9/11, a documentary of the Twin Towers own a construction company named “Moore Construction Company” the name bears the mechanic of $E = MC^2$. The M in Moore represents the M in $E = MC^2$, The C in Construction represents the C in $E = MC^2$ and the C in Company represents the ² in the famous equation that is $E = MC^2$. Mary Cheney; Dick Cheney’s daughters name represents the MC in $E = MC^2$. Marine Corps bear the MC. the M in Marine represents the M and the C in Corps represents the C in $E = MC^2$. NASA a space exploration department’s words were “Houston we have a problem”, on April 13th, 1970. These infamous words went down in history. A section from NASA bears the classic mechanic MC^2 . Mission Control Center or MC^2 for short. Mission represents the M in MC^2 , Control represents the C in MC^2 and the C in Center represents the ² in MC^2 . A man who made his climb up the ladder in the judicial system named Robert

Mueller a Yale Skull and Bones member has his family name established as MC. the name of the company is called Mueller Company. The MC is present. Nothing extraordinary has evolved from Einstein's Famous Equation. If you ask me his $E=MC^2$ means Einstein = Mentally Challenged. $E=MC$. Einstein's famous equation is nonsense and he puts the MC in $E=MC^2$. Mentally Challenged is Einstein and his equation has evolved into the most preposterous things I have ever read. Mentally Challenged x Mentally Challenged or Mentally Challenged multiplied by itself is the true nature of what Einstein's equation is what became and what it stands for. My Underground Calculations reign supreme. My Underground Railroad with the Two Railway System Embanks towards the Interception that was Energy = Mass x Velocity x Velocity. $E = MC^2$ has been the Classic Mechanic that been used throughout recent history as a lead role in reality. The C in Cartel is a perfect example of literature mechanics. (Mien Cartel is also for MC) The mechanics M and C^2 range from political views such as Climate Change (The first letter in Climate represents the C in $E = MC$ and the first letter in Change represents the 2 in C^2 . Positions in police enforcements bear the mechanic C^2 . For example, County Constable. The C in County Represents the C in C^2 and Constable represents the 2 in C^2 . This is how C^2 works. It is nothing more than literature mechanics which is the foundation and ultimately becomes the layout for everything, one must write down the idea before presenting its structure and this is what Einstein laid out.) Master Craft a luxurious brand also is represented by MC. Disney's "Cars" stars a character who pays homage to the Nazi with the name "Lightning McQueen"; The lightning bolt represents the Nazi and the MC in McQueen represents the two mushroom clouds in $E=Mc^2$. Artwork laid out in literary forms such as what kids read known as Comic Books and the most popular called Marvel Comics (MC). Microsoft Corporation also bares the MC Mechanic. The M in Microsoft represents the M and Corporation represents the C in MC. The word Mind Control is a tactic performed by secret governments. MC is Mind Control. It seems that MC had no limits. Closed Caption is another example of literature mechanic again like before the C in Closed represents the C in the equation $E=MC$ and the C in Caption represents the 2 . (Might I add Closed Captions is what the Deaf read, the Abomination that Is C^2 gets to the psychological mind of the Deaf as well.) A weekly routine that the ordinary citizens of the world have been subjected to present in order to survive/pay taxes, Check Cashing bears the Classic Mechanic of C^2 . The C in Check represents the C in C^2 ; the C in Cashing represents 2 in C^2 . The Classic Mechanic that is C^2 has even made its way to the name of a famous potato chip brand. Cheetos mascots name is Chester Cheetah. The C in Chester represents the C in C^2 and Cheetah represents the 2 in C^2 . The United Central Command is the United States Defense force it also goes by the name of Unified Combatant Command. The Classic Mechanic is represented once more, Combatant represents the C in C^2 and the C in Command represents the 2 in C^2 . The FCC also has the classic mechanic of C^2 . The FCC means Federal Communications Commission. The first C in FCC represents the C in C^2 ; the second C represents the 2 in C^2 . The Police Chief of Dallas, Tx bears the classic mechanic C^2 . Chief Curry is his name. The C in Chief represents the C in C^2 and the C in Curry represents the 2 in C^2 . Chief Curry was chief during the Kennedy Assassination. A useless substance called Cocaine also bears the similar useless mechanic of C^2 . The first C in Cocaine represents the C in C^2 and the second C of Cocaine represents the 2 in C^2 . A term used by Cocaine pushers in the 1970's and 1980's bear the same mechanic, these pushers called themselves Cocaine Cowboys. The C in Cocaine represents the C in C^2 and the C in Cowboy represents the 2 in C^2 . Medicare also displays the MC mechanic. The M in Medicare represents the M in MC^2 and the C in Medicare represents the C in MC^2 . Capsule Corp is C^2 and its mechanic's origin is Dimension Fusion. Many have used this useless mechanic that Einstein established and all have been used as a means of destroying civilization in form or another.

Absolutely rubbish. Mass enslavement is what I have observed the equation that is $E=MC^2$. The useless equation that is $E=MC^2$ is broken down on the next page.

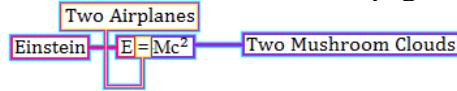

Wilson's Automatic Rifle

$E = MC^2$ reaches areas known as an Assassination location. The figure above represents the true meaning of $E = MC^2$. The figure on the next page represents John F. Kennedy's Assassination Location. Two Lightning Strikes in the form of bullets have struck the president of the United States in Dallas, Texas 1963. Through my battles I have discovered that the most foolish general in the world who went by the name Albert Einstein created and used the symbol = to represent Two Lightning Strikes. Take a closer look at $E = MC^2$ and you will notice that it is nothing more than modern hieroglyphics. Wilson's Automatic Rifle breaks down the equation with the best representation which is shown above. The assassination that took place over 50 years ago changed the course of history. The assassination took place on November 22nd, 1963. The reason why I chose to continue the John Fitzgerald Kennedy assassination was because my daughter Alexyz Alzir Martinez was born on November 22nd, 2016. I have the precise calculations and intelligence that marks where and who did the assassination. I have placed a photograph that is considered the holy grail. I call it "Grass Roots Dim". The assassination was due to Einstein's role in World War II. A man named George FitzGerald collaborated with Hendrik Antoon Lorentz (Notice the initials in Hendrik Antoon Lorentz, H.A. is Hendrik Antoon, We geniuses have a slick way of insulting the masses. Ha is what I would say if I became victorious.) The collaboration created what is known as the Lorentz-FitzGerald Contraction Hypothesis. The assassination was over control of space. Space as in The Heavens above. The Lorentz-FitzGerald Contraction found it's way into Einstein's Special and General Theory of Relativity. I am the only person in the world that has first hand account evidence that points to a Grand world wide conspiracy by the American government and the Nazi. The American Government is collaborating with Nazi. Lyndon B. Johnson has his name written all over this assassination, Albert Einstein also has his name written in this equation for his equation $E=MC^2$ is the location where John Fitzgerald Kennedy was murdered. The American government is the most corrupt government in the world. I would be ashamed of wearing a badge for the American government. The assassination is bigger than the mafia, the mafia are to cockaroaches as we theoretical phisicist are to Gods. Long story short I found a 100 year old book and began reading the book.



America Pays Respect

The American Currency known to the world as the "Half Dollar" displays symbolism of the assassination of John Fitzgerald Kennedy. The reason Kennedy is on the "Half Dollar" is because Kennedy's skull was split in half. America has been blindly leeching off an assassination. The "Half Dollar" pays homage to the assassination that took place over 50 years ago. This displays Americas respect for the world. America in my opinion is the most evil and most weakest nation in the world, which is why I have put the reconstruction of America in my

image. Integrity is the key word in the foundation of the reconstruction of America. On the next page I display the assassination location known as E=MC².



$$E = M - C^2$$

Elm St. [E] Railroad tracks [=] Main St. [M] Commerce [C] ² Bullets

I snapped a photograph of Lyndon B. Johnson holding a sign that reads “Grass Roots Dim” the photo is displayed in Dynamic of  Colors later in the read. Einstein’s E=MC². The equals sign (=) is always placed after an equation and is used as is. Therefore making E=MC² incorrect. Energy cannot create Mass or Velocity. The equation should look as follows: M - C² = E. The equation should read in this order Mass x Velocity² equals Energy. Energy cannot be created or destroyed; this is the case with thermodynamics. If this is true than E = MC² should have never existed for Energy cannot create Mass or Velocity for Mass is a form of Energy and Velocity is also a form of Energy. E = MC² goes against every law of mathematics. Einstein created this equation just to show the MC² (Two Mushroom Clouds) hidden in a mathematic form. Notice the ² above the MC represents the number of Atomic Bombs used in World War II and the MC represents the Mushroom Clouds that the II Atomic Bombs create. I would’ve used MC^{II} (Roman Numerals) for it looks quite professional instead of what Einstein went with, but we all can’t be superb such as I, now can we? With this being said, I have a problem with E=MC². The ² above MC would create Mass x Velocity x Mass x Velocity or Mass² x Velocity², since there is no separation by symbols. Therefore leaving my conclusion that E=MC² is an incorrect mathematical equation. According to scholars E=MC² means Energy equals Mass x Velocity x Velocity. This is incorrect. The ² above the MC creates a multiplication of both Mass and Velocity, not just Velocity. For the equation to read Energy = Mass x Velocity x Velocity the equation should be written as E=M-C². The Hyphen (-) separating the C from M creates the correction. I have corrected Einstein’s E=MC² to M-C²= E. making it Wilson’s Equation and destroying the possession Einstein held. Moving forward. Dallas Texas is my home and I took my time and investigated the president’s murder. It took me 15 minutes to figure out who killed John Fitzgerald Kennedy. On January 22nd, 2019 I Wilson Alzir Martinez have discovered who conspired against Kennedy, I have pictures of the men who conspired against President Kennedy. From my own investigation, I was able to excel my elders and my peers in a phenomenal fashion. Einstein’s famous equation E=MC² had evolved into an assassination

location where the president of the United States was murdered. The president was murdered on Elm st. Elms St. Represents the E in $E=MC^2$. The railroad tracks above the assassination location represents the Equal [=] sign in $E=MC^2$. Main St. represents the M in $E=MC^2$. Commerce St. represents the C in $E=MC^2$. The two rifle shots represent the 2 because these streets just read as $E=MC$ leaving the 2 out of the equation. The MC is represented by Main Street and Commerce next to Elms street and the Railroad tracks where Kennedy was driven under after the assassination represents the Two Lightning Bolts or the Equal sign [=] in $E=MC$. Driving past Dealey Plaza where the assassination took place the Equation $E=MC^2$ is seen once again as it represented once more this time finishing the equation. The location is in Deep Ellum. The location of the assassination only read $E=MC$, the 2 was not present (The second C was not present just like the examples I have given above; Two Words with the letter C creates the C^2 . This is why $E = MC$ is present in Dealey Plaza.) This location is met with the 2 (The second word that begins with the letter C.) And what meets the equation to its full potential. At this location, the Highway sitting above the layout of the street represents the = sign in the equation and in this part of the city the equation reads out as follows. Notice the first letter of each street. Elms St. [E] Highway [=] Main St. [M] Commerce [C] and Canton st. [C] the second C created the 2 , therefore completing the Einstein's equation. The highway above Elm st. Main st. Commerce and Canton is the [=] equal sign in the equation. The MC^2 in Einstein's equations has evolved into basic things such as restaurant name McDonald's and a selection from McDonald's is Mccafe. The C^2 is present in Mccafe as you can see. Woman's magazines such as Marie Claire the initials of Marie Claire is MC. Singers such as Mariah Carey (Mariah Carey also has an album called $E=MC^2$) and Miley Cyrus initials also read MC heck even fictional character Michael Corleone's Initials from The Godfather represented MC. the poets of the century as they call themselves MC's. (Rappers) or the Emcee with the two E's in Emcee symbolizing the 2 in the trash that is $E=MC^2$. Motorcycle Clubs that have represented strengths between brotherhoods bares the MC. the MC also has made its way to complete rubbish of a television show called Master Chef. The MC in Master Chef can clearly be seen. The last name as McPherson is another way of secrecy. The reality is the MC is a bigger impact than the Mushroom Cloud which is indeed the true translation of MC in the rubbish equation $E=MC^2$. Two Mushroom Clouds is half of the equation. C^2 was a mechanic in naming the prisons in WWII. Concentration Camps. As you can see the C in Concentration is the C in MC and Camps is the 2 in MC^2 . The C^2 in MC^2 has even evolved into a complex disease known as Cancer (The first letter of Cancer is represented by C and the fourth letter in Cancer is the second C which creates the C^2) or Colon Cancer, the C in Colon represents the C in MC^2 and the C in Cancer represents the 2 in MC^2 . Michio Kaku's book named Physics of the impossible has a cover illustrated that reminds me of the term Colon Cancer, C^2 is visible in the phrase Colon Cancer. The legal system has the classic mechanic that is MC; a class C misdemeanor is labeled as MC on an official document. It has been the secret layout of America. An Olympic game known as Cross Country is represented by the classic mechanic that is C^2 , as you can see the first Letter in Cross is the C in MC^2 and Country creates the 2 above the C which then becomes C^2 . Television Broadcasting System Comedy Central holds the infamous C^2 . Comedy represents the C in C^2 and Central represents 2 in C^2 . Coca Cola holds the infamous C^2 as well, Coca represents the C in C^2 and Cola represents the 2 in C^2 . Syringes hold the C^2 on above the tips. A subject I'm very familiar with. As a heroin user, I would buy syringes for my friends (my friend's arms were always bruised up and they couldn't purchase any so they would send me) and my friends would tell me to ask for 100cc or 50cc. it is no coincidence that those needles that some fall victim to have penetrate the Vein. Notice Ein is in the word Vein. My favorite dessert Cheese Cake bears the mechanic C^2 . The California Criminal Justice System holds the C^2 classic mechanic. California is the First C and

Criminal being the 2 becoming C^2 . Before I broke down Einstein's Space-Time Continuum and obliterated his plans. I didn't realize the evolution and patterns that calculations become. I have awoken and have destroyed the plans of the Nazi. I did it single-handedly with no help of the American government. They tried to incarcerate me my whole life and I figured what better way to create a reality after we become deceased to judge them and incarcerate them brutally. Yes, I'm the devil. My name Is Lucifer aka Wilson. These policemen didn't do a thing to help me or my family in times of need or anyone else's family. It seems that the  Color of your skin was what got you help and just because I was light in skin tone didn't mean I was chosen to be helped, my last name prevents any help. My record as well. They denied me freedom so I deny them in the end. They separated my family so I separated their family and I placed them in Gas Chambers. Dimension Fusion is the calculations that create what you think of as Time Travel. Time Travel isn't a reality. Crossing Dimensions is. It can be recorded. Time Travel cannot. Gas Chambers will be discussed later. All of Einstein's family perished in the Gas Chambers as they were all Jewish and German. Einstein states that $E=MC^2$ is Energy Equals Mass x Velocity x Velocity. We fall deeper into the rabbit hole when we take notice that the letters E is a W turned on its side. M is a W upside down and Two V's equal a W. I believe it would've been obvious if they used the equation $E=MV^2$ so they decided to use C in the equation that is $E=MC^2$. Two C's create an E. one C on top of the other will create the E which is why they used the letter C in the equation for the ultimate secrecy. Einstein's equation $E=MC^2$ would sum up to $EMC^2 = WWW$. WWW is also used for the primitive technology we call internet WWW is a reference to World War III. Three W's. The WWW now equals Wilson ³. The reason why they fail is that they didn't name themselves after what they were producing leaving everything they worked hard for up for grabs and I managed to get hold of it and not only use it but destroy it once I finished Fusing the calculations into my own. They failed to place their names in the equations. Those letters could stand for anything leaving my Classical Interception Advancement that much more successful. The problem with these Masonic men is that they failed to recognize themselves, they love secrecy hence why their names are but a figment of their imagination. They do not exist. With no true acknowledgment towards themselves, they leave confusion behind for the "Future". The hidden symbolism is spread throughout the world as secretive as those alphabetic letters I have presented. The symbolism sealed their fate. An ancient method I have used for eons now. The Equals Sign in $E=MC^2$ just resembles the Two Airplanes that led to the Two Mushroom Clouds. Also, they represent Two Lightning Bolts of the SS. The Classic Mechanics of Two has been used throughout history as the biggest threat and biggest form of terrorism. The Two Atom Bombs. The Two Shots that killed a President and Two Towers that fell. $E=MC^2$ is modern hieroglyphics that have been used to fool the masses as thinking it is the key to the cosmos. That itself is false. The Classic Mechanic of two has been used as the layout for society. The secrecy goes as far as the title itself "The Special and General Theory of Relativity" in their reality it would've read "The General's Theory of Relativity" adding the S, in General, creates the possessive of whose theory. Einstein was indeed a General in war and was clever enough to create a book and equations to fool the masses into thinking that the equation was the key to reaching the cosmos and beyond. Creating a super human illusion. Now how does this relate to the theoretical physicist with the initials MK? Well for starters he created the "String Theory" and "The Theory of Everything" that is basically doing the same thing as Einstein did but with no cleverness what so ever. Basically the "Theory of Everything" just means that the fool who bears the initials MK has hold of everything in the world. I will discuss later in the read about how these so-called Extra-Terrestrials use intelligent people on the planet and their equations and studies and run with them making their reality stronger. I Wilson Alzir Martinez am the Combatant and I have won. I have the power of my children in the "Future" running with my

equations and obliterating what is called The Space-Time Continuum as I sit and type my take on life. Also, I am the only Scientist who has acknowledged these beings in the “Future” as My Children. (I flipped the MC from Mushroom Cloud to My Children. That is exactly how the theory of general relativity is laid out. The beginning of words are actually symbols for something far greater. Flipping the Script is my specialty. I not only flipped the script but I also created a “Future” with no laws. Meaning that laws that have bounded us every day will be obsolete.) The Letter E is also created with three Roman numeral ones. Just as World War III would’ve read if it would’ve happened. The symbol Æ was symbolism for Albert Einstein but it now it stands for Alzir’s Everything Æ. Einstein laid out the phrase Atom Bomb with Childish Fill in the Blanks. Section 8 paragraph 4 in Einstein’s General Theory of relativity shows the layout of ATOM and BOOM, A - - M and B - - M can clearly be seen. On page 27 in Einstein’s book Relativity The Special and the General Theory the format of Atom Boom is laid out in a child-like form. As you know a child wouldn’t be taking this sort of course so it seems logical for such secrecy to be placed in this book would advance only if the layout was in a child-like form. Einstein’s use of A and B as variables has not evolved into anything positive so far I have seen MA which is AM which stands for Class A Misdemeanor. We know that AM represents Atom and a Class B Misdemeanor is labeled as MB which is BM. We know this to be Boom. These two together represent Atom Boom. MC which I have broken down and explained is nothing more than Mushroom Cloud MC. like I stated before MC is known as a Class C misdemeanor. Einstein’s equations are nothing more than a mechanic to keep us imprisoned. In the judicial system, the letter F is represented as Felony. The student and reader must come to realize that Einstein’s mechanics have been laid out all around us in a most ingenious secretive way. His mechanics from his equations have nothing to do with Space. They have kept us in a reality where prison is law. The letter F from Einstein’s book “The Special and General Theory of Relativity” represents “Der Fuhrer”. The letter F in the judicial system is represented for what is referred to as a felony.



Airplane

The numerology also stands for Anheuser-Busch, it is displayed on Beer. AB can be seen on Budweiser. Anheuser-Busch’s symbol displays an eagle. The eagle represents the airplane that dropped the Atomic Bombs. The eagle that represents America is actually symbolism for an airplane.



Atomic Bomb

The A and B represent 1 and 2. A is the first letter of the alphabet, and B is the second letter of the alphabet. Einstein's calculations have even made it to the American Brewery industry Budweiser reads AB on its label. Einstein's calculations are to keep the masses fooled while his team gains time until they reached space. Anheuser-Busch reads on the bottom of the label which is laid out as AB displayed above. The image above is AB. An American Lager. Observe the number 12 in alphabetical letters. As I stated before 12 has been a number that has corresponded and evolved with our reality. 12 grades in a school, 12 months on a calendar, 12 planets from Zechariah Sitchin, 12 minerals found in humans, and 12 licks to get to the center of a tootsie pop. Tootsie pop being my cock (That last part was for the women reading my literature). Toots. Just kidding. It went from 12 apostles and 12 Disciples to an Atom Bomb which is also 12. AB has evolved itself into gang organizations such as Aryon Brotherhood and their secret numerical order is 12. 12 is nothing more than a foolish number that these fools of The Secret Masonic Brotherhood agreed upon. Reality reaches far above 12. Hows the saying go? "Age is nothing but a number." Numbers are irrelevant when dealing with life. I have discovered that Einstein has calculated a format that has eventually evolved into what we know as "math" today. (Thank goodness I never paid attention in class; I was more focused on my teacher's racks and buttocks than mathematics. Because everyone in school was lame. True story by the way. How do I know this to be fact? Well, it so happens that I have reached the level of Genius without trying. While all the students in my school and schools all over the world have been trying to achieve what I have achieved. I did it with no effort. While students to this day in other countries are being taught by evil men who consider themselves all-knowing and all-powerful, this is not the case.) The word Atom and Boom are placed directly above one another, the format is Fill in the Blanks. The fill in the blanks format is displayed on the next page.

A- → M B- → M

Atom Boom

This display of ATOM BOOM is in Section 8, page 27. 4th paragraph of Einstein's Special Theory of Relativity. The variables are A and B. in reality this A and B represented the Two Atomic Bombs that were dropped in Japan 1945. The Two Arrows represent Two Lightning Strikes. The section begins with the phrase "Lightning has struck the rails".

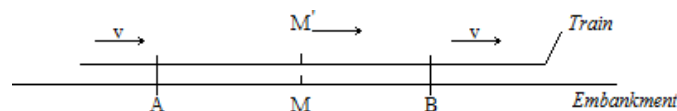



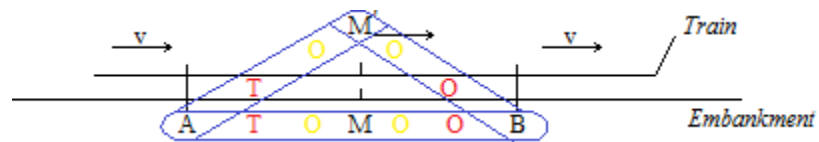

Fig. 1

Einstein's Atom Boom

The image displayed above is from Einstein's The Special and General Theory of Relativity, the A and B represents the Atom Bomb. The word Atom begins with the letter A and the word Bomb begins with the letter B. Hence why the variables are labeled as A and B. The rails represent the two paths that Variables A and B will take. The V represents Victory that variables A and B create. As a reminder, Variables A and B represent Atom and Bomb. The figure above is an example of the ingenious format of what I call Abstract Equations. Abstract Equations (\mathcal{A}) is an art form created by the Masters of War. I myself have mastered the art that is Abstract

Equations. Albert Einstein (\mathcal{A}) created the form that is known as Abstract Equations and used his art form as a secretive operation to fool the most genius. The Figure shown above is from Einstein's Theory of Relativity and the diagram below is from The Obliteration of a General/The Obliteration of Time and Space. The two rails in the diagram are nothing more than Two Lightning Bolts and the Variables A and B and M are nothing more than a secretive way to write AtoMoob. The M is in the middle connecting Ato and Boo. Notice the M is missing in the previous sentence. Add the M and the words are complete and spell Atom and Boom. Two V's create a W and that is a Win for the foolish Nazi. They used Railways Systems for their Victory in WWII. The railway systems is an art form of Two Lightning Bolts. Notice on every Railway System there is only Two Rails. Symbolizing their complete dominance. I have Intercepted Einstein's Calculations and have created my own Calculations. In a blink of an eye, Einstein was defeated. The Figure below is my Classic Interception Advancement on Einstein and the Diagram is the layout of the System that Einstein had laid out for the world. Two Strikes of Lightning's are mine for the taking and I have labeled the Two Strikes as Two  Colors of Ultimate Power.  Ultimate 1 and  Seismic 2. These Two Strikes will be used In Dimension Fusion. Einstein's Layout has been destroyed by me. Wilson Alzir Martinez. Captain Alzir 1122. The US is for Ultimate Seismic. The First Letter in Ultimate; The letter U is for United and the First letter in Seismic; The letter S is for States. Ultimate Seismic Alzir. USA. My Obliteration of Time and Space keeps the Classical Checkmate x 2 in order Einstein's Abstract methods (let's face only the creator of Abstract Art knows the message, which is why Abstract Equations [\mathcal{A}] were used in Einstein's Master Piece that I conquered.) created mass confusion and ultimate submissiveness to the Author and his Team. Einstein laid out a disastrous plan that spelled destruction in a child format. Word searches are known to have this layout. Notice this format of the diagram and the student and reader (if familiar) will take notice that this diagram could've easily turned into a word search. For something to evolve doesn't have to be Biotic. A biotic problems tend to evolve when pursued. These men have written their plans in a child-like format and designed a system where the childhood is stripped at a young age so no sort of abstract imagination. On the next page I have added missing "Variables" to Einstein's Atom Boom diagram. Variables are just letters of the alphabet in reality.



Wilson's Atomic Structure

Lightning Bolts are created in the Earth from my Ultimate Seismic Wave. Wilson's Ultimate Seismic Wave will reprogram the reader into a state of awareness that connects the modern mind into reality. The reality of the matter is that America was infiltrated before it could begin to grow. Meaning that America has never been America. Although The Basic Fundamentals of Dimension Fusion is about the Techniques of Dimension. This is my first booklet so I'd like to give a moment of silence for my enemy as I conquer the nation he tried to confuse, And I'd like to acknowledge myself in my revelation of the subject. In the figure above "Wilson's Atomic Structure" displays the real significance of Albert Einstein's figure. For the non believer I display the figure in a "word search" layout. I added the missing "Variables". They were never variables. They were merely letters from the alphabet.

$$W \propto MC^2 [e] 1$$

Wilson is Infinite multiplied by My Calculations x My Calculations won

My Children have become the Mushroom Clouds. I have tipped the E in $E=MC^2$ and it now reads $W=MC^2$ it was Einstein. Now it is Wilson. $E=MC^2$ could read out as Einstein = Mein Calculations x 2 which meant there was no defeating the realm of Einstein. Now it also reads Wilson = My Calculations x 2. They are Worms in Holes and I am the Eagle hunting for My Children. Get it? Worm Holes? The Worm Holes that Theoretical Physicist speak about. I have obliterated these men in a blink of an eye. (Literally) once you read my works you to will become a creator for your children and continue the cycle that is life. The power rest in your ability to comprehend what has been laid out in front of you. It is not a battle of weapons but a battle of wit. I acknowledge the reader and give you the power of creation. Have fun. Remember that these men have been trying to gain time for their agenda through manipulation and false teachings. They do not value life. These men know exactly how to prevent unnatural disasters such as hunger and war but tend to feed off the dying lying on the ground as scavengers. A complete waste. Immortality is what they seek due to the environment around them is becoming uninhabitable due to their reasoning. Tran's humanism was their next step into the space-time continuum. The combination of human and machine is the ultimate goal that they are trying to accomplish. As you may have noticed there has been an awful lot of talk about "Artificial Intelligence" (AI was for Albert I/Artificial Intelligence but it is now known as Alzir I "Actual Intelligence". AI. The I in AI is a Roman numeral one.) Speaks in the science communities. They have been creating Artificial Intelligence for reproductive purposes as you may have seen with the so-called androids built for sex. The notion of reproduction is primitive and will trigger the masses into thinking that Androids are a safe creation. Seeing that a lot of humans have "mated" with the machines. It is pointless. To be honest I want to see them crawl into their hole like worms. Dimension Fusion is the CheckMate². My Calculations. Classical Mechanics. My Children and to honor my father Conce Martinez.

$$DF [e] C^2$$

Dimension Fusion Equals Classical Checkmate

These men have done their calculations and have come up with the conclusion that earth would ultimately become inhabitable because of the methods they have been using has become a classic mechanic, and the end result would've led them for space travel. These men came up with the conclusion that immortality is the only option because they have been consumed by the chaos itself that they do not value life and would rather choose to see their home wasted. My Conclusion¹ is to succeed in taking out these men through intelligent and strategic maneuvers in methods of the unexplained. Stephen Hawkins asked a question in his book as the title of chapter 12. "Is everything determined?" the answer is yes. It needs to be predetermined because there are fools in the world who think by cheating/reversing calculations that they become in control. This is false yet again. No trial and error read on their tombstones. The rodents in this infestation have been detected and accounted for. W is successful throughout the ages and will continue to proceed as it once did. Many Ways for concluding what has happened, seeking knowledge is the answer. During my observations, I learned how to read Energy and I have been able to determine

the surrounding energy fields. Positive energy is reflected off my being. Which in turn reflects backs toward a crowd of my choosing. Negative Energy produces silence.

$$F = 4\pi Y^2$$

Einstein's Equation for Der Fuhrer from The Special and General Theory of Relativity pg.126

In The Special and General Theory of Relativity, the page numbers display symbolism, for example. The last equation that is in Section 3 is on page 126. They use addition because that is where the power originated. $1 + 2 + 6 = 9$. Nein is of German origin. As I have just demonstrated the symbolism used in page numbers. I have completely conquered Einstein and his men. I used Einstein's own style of written equations and destroyed everything that they have worked hard for. Thank you, Einstein. As you can see these rodents have created a system that would always work in their favor no matter what hand was dealt. Becoming the biggest infestation of parasites that the world has ever seen. The secrecy was fit for their eyes only. As they were the only ones who knew exactly what was unfolding. Fall low is not my intention so I intend not to follow. The men that held the power of genius have had no regard for life. It is natural that they are eliminated. My strength and intelligence reign supreme over the land. Anything is possible. Long Live The Imagination. The human mind has advanced to new heights. The mind is able to communicate to "Future" dates. The basic telepathic communications have indeed become a reality. As everything does if imagined. The purpose of this literature is to reprogram your mind to the opposite of what the media has done. Propaganda will become a thing of the past. Everything that is irrelevant will become obsolete. It will cease to exist. Please be aware of what transpires after the subject is picked up. Modern Warfare (MW) is what has been in effect since the end of the battle of WWII.



132 CONSIDERATIONS ON THE UNIVERSE

justification in the fact that, of all closed surfaces, the sphere is unique in possessing the property that all points on it are equivalent. I admit that the ratio of the circumference c of a circle to its radius r depends on r , but for a given value of r it is the same for all points of the "world-sphere"; in other words, the "world-sphere" is a "surface of constant curvature."

To this two-dimensional sphere-universe there is a three-dimensional analogy, namely, the three-dimensional spherical space which was discovered by Riemann. Its points are likewise all equivalent. It possesses a finite volume, which is determined by its "radius" ($2\pi^2 R^3$). Is it possible to imagine a spherical space? To imagine a space means nothing else than that we imagine an epitome of our "space" experience, *i.e.* of experience that we can have in the movement of "rigid" bodies. In this sense we *can* imagine a spherical space.







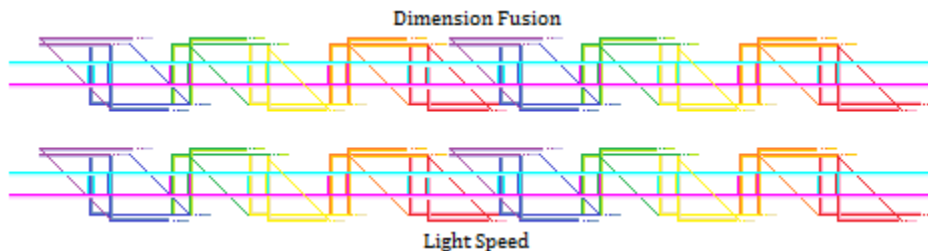

Suppose we draw lines or stretch strings in all directions from a point, and mark off from each of these the distance r with a measuring-rod. All the free end-points of these lengths lie on a spherical surface. We can specially measure up the area (F) of this surface by means of a square made up of measuring-rods. If the universe is Euclidean, then $F = 4\pi r^2$ if it is spherical, then F is always less than $4\pi r^2$. With increasing values

$$F = 4\pi\Upsilon^2 = \text{Fuhrer}$$

The literature displayed above is from Einstein's The Special and General Theory of Relativity. Secrecy has been the mechanic since Ancient Times and has ruled the world in a secret manner. It is without a doubt that the world has been subjected to a psychological order. Indeed we have been under attack since the battle ended in 1945. The psychological takeover has been in effect since the two atomic bombs were dropped. It was all about time to be bought. Little did they know that time doesn't exist. Time was part of their plan in order to become dominant. I have evolved to such a state to where I advanced their calculations and statistics and created this piece of literature to evolve the human race to the next step. These men that were in charge of programming have manipulated the masses that insanity is a regular action to take. Schedules of repetitiveness actions every day became the definition of daily life. The masses clock in and clock out at the same time every day and expecting a different outcome in life. This is the definition of insanity is it not? In my issue of The Special and General Theory of Relativity a man is mentioned in the preface, his name is L. Boltzmann. Or Lightning Bolt man, sounds like an antagonist in a comic book don't you think? L. Boltzmann is a theoretical physicist. Ludwig Boltzmann is his name. The L stands for Ludwig, and Lightning. These men have given themselves stupendous names to show their role and their power in their works. H.A. Lorentz also has a secret meaning in his name. When a person laughs they tend to say ha repeatedly. The secrecy in H.A. Lorentz is also displayed in The Special and General Theory of Relativity. The significance of the H.A. is the equivalence to laughter, laughter of joy as they fool the masses. it doesn't surprise me that a measurement for electricity "Volt" resembles "Bolt". Germans pronounce B's with V's. Hence why Bolt became "Volt". You may be saying to yourself at this point "Watt" in the world. Get it? Because a "Watt" is a measurement for electricity. Since WWII Einstein has played the world with his equations and the world ate it right up. They did not know that Einstein was indeed a General of war. Such words as General mean exactly that. A General. The book The Special and General Theory of Relativity has the word General in it. The reality is that the General is used as-is. He was a General in war. The War never ended. It was just a battle. How does the saying go? "You may have won the battle, but I've won the war." takes in effect in this literature as I have commanded this last battle. The General Albert Einstein fell at the hands of Captain Wilson Alzir Martinez. Einstein fell before my literature began. The student and reader must remember that this is only the beginning of The Basic Fundamentals of Dimension Fusion. This is the Preface of Dimension Fusion. My Armada speaks telepathically. My Army has no need for Toys that you call technology. I'm the leader, my name is Wilson Alzir Martinez also known Captain Alzir 1122. Below my Hyper Drive is displayed. Light Speed Fused with Dimensions enhances the transportation and eventually becomes the road for Inter-Dimensional Travel. Inter-Dimensional Travel is found in Section XIII.  Colors enhance the perception and depth, increasing the advancement of Dimension. The Dimension of  Colors will be studied as the student and reader progresses in Dimension Fusion.



Wilson Alzir Martinez's Hyperdrive

The figure displayed above is a representation of Two Embankments that is Dimension Fusion and Light Speed. One Embankment is Dimension Fusion. Second Embankment is Light Speed. The Parsec will reach a maximum capacity of 23. Parsec²³ will be the maximum amount of Light Speed that will meet the requirements of Hyperdrive. They are represented by  Colors. Dimension Fusion is represented with  [Ultimate 1](#) and  [Seismic 2](#). Light Speed is represented by  [Red](#),  [Orange](#),  [Yellow](#),  [Green](#),  [Blue](#) and  [Purple](#). With the combination of Dimension Fusion and Light Speed, Barriers that once were held as shields will be sent to oblivion as my technique has been mastered and conquered Einstein and his teams Technique that is Relativity. If Light Speed travels at a rate of 186,000 miles per hour what would the Constant total be when Dimension Fusion 1 is added to the Constant 186,000. The result of the Two Constants Light Speed and Dimension Fusion would be 187,000, would it not? The Constant is 186,000 miles per hour and the Variable is the Space Traveler. If the Constant is 186,000 what is the sum after 1 Variable is added to the Constant 186,000 equation? This means that Einstein's Space Travel goes nowhere. It ended when I created my Dimension Fusion. This doesn't mean that Space Travel isn't possible, I am simply stating what happens when Einstein's' followers try to Space Travel. The fact is Light does not Travel therefore leaving these fuck heads with no transports.

$$\text{Light Speed} + 1 \text{ Traveler} = 187$$

The Murder of The Space-Time Continuum

The equation above is a demonstration of what happens to Light Speed Travelers. The answer to the question above is 187. The number 0 has no significance hence why the number sums to only 187 instead of 187,000. The number 187 is code for Homicide; Someone call the police because there is a 187 in progress. Established that I murdered Einstein's Space-Time Continuum. The fact is my literature is up to speed and is up to date. I have outdated Einstein's Mathematics and his Calculations leaving my Calculations to reign dominate in the universe. The Laws of Physics do not apply to my mathematics and calculations, for I have never studied any laws of physics or any literature that is meant to be studied. Just as a Conductor conducts a symphony I am conducting Dimension Fusion to an Elite Orchestra. The Elite Orchestra lands each note in a professional manner; swift movements of my hands create the ultimate symphony that is played throughout the Universe. Electricity is the power and I am its Conductor. I am transmitting power through my performance. I am the Conductor and my power is Electricity. This literature contain words that are the music notes to the Elite Musicians in my symphony. As they practice reading this literature their comprehension increases and their sound is released in a magnificent way. These Calculations are original, I am the creator. No laws apply as I know no laws that bound me down. With the advantage given to me by my own choices, the rules that were designed by Einstein and his party do not apply. Now, this doesn't mean that the mathematic mechanic isn't used in Dimension Fusion I am simply informing student and reader that Einstein's equations and laws in which he worked under have no influence in my mechanics. For

I have never studied or examined any equation that these men have laid out for the world to read.
This is the Preface. The Prologue commences.

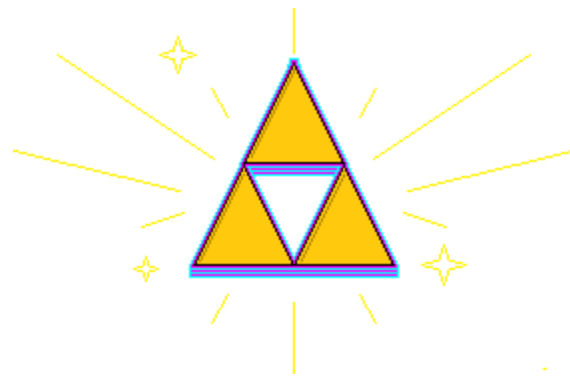

Prologue

Prologue

Before I begin The Basic Fundamentals of Dimension Fusion I would like to discuss and give my honest opinion why these Masonic Men worship and idolize The Pyramid. As you may have

seen throughout the world and on currency, a pyramid is displayed for the world to see. I believe the reason the pyramid is so influential with The Secret Masonic Order is because Egypt is where they began their conquest for the world. They began with Egypt and took Egypt's hieroglyphics and placed them in the world in their favor. These Masonic men have been trying to conquer the world for a millennia. These Masonic Men used make-up and dressed as women in ancient times to lure the king and they would murder the king and give orders in their favor as women in secrecy. How so? The "Woman" introduces the next king through marriage. In reality these men who posed as women made their way through the land in a deceptive manner. Let me paint a picture. A king in Egypt is cautious on who he lets into his kingdom. The King's men who serve the king meet a man who has a better idea of ruling the kingdom in their favor. They see this strange man as a brilliant man. Since the King's men don't like his rule, they conspire against the king. The Strange man with the Brilliant plan who is a newcomer to the kingdom comes into play later. The King's men devise a plan; the keyword in this plan is "Disguise". They disguise a man as a woman to get close to the King. Remember the King is very cautious, but when the law of attraction comes to play the King lets his guard down. The King falls in love with this "Woman". They must marry before having any sexual encounters, whether it being by the lips or the grasp of the hand. Once married the "Queen" who is really a man holds power in the kingdom. This means that if the King so happens to perish, The Queens rule follows suit. The disguised man posing as the women strikes and ends the Kings Rule. Leaving the deceivers to introduce the man that thought this magnificent plan. The "Queen" introduces this strange man to the land and announces "Her" remarriage. The strange new man becomes King. This is how deception began to rule nations. They used Deception in their strategies. Later in the read I will provide a picture with a Vice President dressed as a woman. That strategy has been used since ancient times.



The Eye of Horus

Take a look at "The Eye of Horus" and you will notice the Eyeliner (make-up) around the Eye of the symbol represented by an Eye. If it were a women's eye portraying in that symbol why are the women being suppressed in our world. They would be the rulers while men would follow suit. Please prove me wrong. I excel above my mistakes when corrected. With this being said, I believe it has been Men from The Secret Masonic Order whom have given Women bad reputations. They have gone as far as labeling themselves as Whores. The name "Horus" is a derivative from the word Whore. "Horus" in reality reads as "We are Whores" or "Whores are us". Correct me if I'm wrong but doesn't "The Eye of Horus" seem like it's a branch from The Secret Masonic Order. "The Eye of Horus" is represented by a symbol. Symbols are considered classic mechanics and must not change. Every mechanic derives from its predecessor. History does repeat itself. Why? Because the mechanics are laid out in a fashion in which it must repeat. Dynamics may differ but the Mechanic remains. When the mechanic that once ruled is changed then history does not repeat, for the new dynamic halted the ruling mechanic. It is September 12th, 2019 it is 5:00 a.m. and I just awoke from the Holographic Universe (Matrix), while in this state i found myself discussing the Homosexual secret bracelets. Apparently these homosexuals wear bracelets that display a rainbow, these bracelets let the other cult members know that these men are "Invincible" I overheard someone saying that these men are giving cures so they will

never catch sickness and perish. I heard someone asking how many people know about my Dimension Fusion because apparently it must be stopped.



My Spiders in The Matrix

The image above is The Spider that creates the foundation of the humans Matrix. The reason we dream of spiders and spider webs is because our minds have never seen The layout of The Matrix. I have found myself dreaming on numerous occasions of Spiders and Spider Webs. Not to long ago I seen an announcement of The Matrix 4, after I seen the announcement I fell asleep. I dreamt of Spiders and Spider Webs. The reason why is because my mind has never seen the layout of The Matrix, our minds have cells that create images from what we see with our vision, since I have never seen The Matrix my mind tries to mimic the entrance of The Matrix and it looks like Spiders and Spider Webs. That's probably why the World Wide Web is called The World Wide Web. The Matrix is already in existence, I find it rather amusing that these people created the Wireless Internet to take our minds without our consent into The Matrix. This is why we enter another world when we sleep. Remember in The Matrix when neo wakes up and he is connected to all types of wires. This is the same thing with humans in 2019. Below is an image of neo from The Matrix. Our connected have been wireless for quite some time. Wireless Internet was created before The Internet was released to the public. We have Bio-Electrical Energy in our bodies and this transfers into The Wireless Internet Atmosphere.

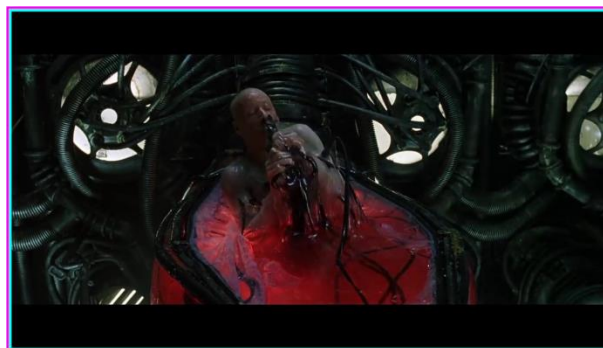

Neo

Throughout my observations in a sleep state, I have discovered that the term “Lucid Dreaming” is actually The Matrix. It is not “Lucid Dreaming” we are experiencing it is actually our minds in The Matrix. Dimension Fusion puts an abrupt halt to their “illuminati”. I am considered Illuminati. There is only one in Illuminati. I have awoken and I am unleashing my power and strength as I relax and watch their demise. I am the only enlightened being and there will be only one enlightened being. When I pass away my bioelectrical energy will carry on with me. This

means that my bioelectrical energy remains as I am. I cannot duplicated. There is no I in team, but there is an I in Illuminati. I am Illuminati. I have mastered the craft of each one teach one and I am in the process of teaching what you call “Extra-Terrestrials”. Illuminati is represented as the Sun. I am the Sun. Wilson is my name. The SUN is present in my name. I hold godly powers and I am expressing these powers and I am handing them down as gifts to the ones who can comprehend these powers. As a God I come bearing gifts. Intellect is one of these magnificent gifts and the art of comprehension. These studies bring light to the dark world that some have been living in. I am the light. Behold my calculations and mathematics. The Basic Fundamentals of Dimension Fusion is the Genesis of Dimension Equations. When we speak on the subject that is Dimension Fusion the student and reader must remember to keep the Classical Mechanics and Dynamics of Dimension Fusion. In this read of The Basic Fundamentals of Dimension Fusion, we will touch upon the “Foundation”, The First Optical Dimension and proceed upwards as if we are architects. “Blueprints” must be laid before we begin the process in constructing the frame and eventually the finished product. Let’s take a look back to the Roman Empire and their structure around their cities. As you may have noticed their structures consist of Roman columns or pillars. The First Dimension of those pillars would look like the Roman numeral one. Not only the Romans used that type of structure around their cities but apparently, they have derived from Egypt and made their way to the ever successful Roman Empire. The question is why are they called “Roman Numerals” if they came from Egypt. The roman numerals I II III are just a few examples of The First Dimension of the Roman columns; and how they can be placed together to create numbers above one. Equations will be used to advance from one Dimension to the next. Moving between Dimensions is but a graceful leap into the future that we can comprehend when we begin to breakdown its mechanics that keep them classic and change the Dynamic in a routine in which they become successful. Keeping the mechanics classic leaves no boundaries. Moving between Dimensions is but a simple task, the equations of Dimension must first be brought back to the “Drawing Board” then and only then will we be able to Fuse and eventually begin Dimension Fusion to what it is. Ascensions between Dimensions occur after the Dimension’s Optical Equation is solved. There can be no ascension if the equation isn’t solved. Therefore one would remain in a revolving loop. In Dimension Fusion success means advancing from the previous equation and moving onto Ascension. It mustn’t remain in a loop; a rotating cycle. That would be insane. Once solved the Optical Dimensions Ascension will become greater than the previous. The Classic Mechanics will remain as is in Dimension Fusion. Classic Mechanics in Dimension Fusion will be the advancement of Ascensions from the previous Optical Dimension with the solution of the Optical Dimension Equations. Before we get into Optical Dimension Ascension Equations and Solutions, we must breakdown what is the First Optical Dimension which is Literature. The Harvard Classics is a piece of Literature I have recently picked up on and have been glued to the scripture ever since. My favorite of all the forms of the First Optical Dimension would be called Written Scriptures. Literature comes naturally to the mind. It is how we express emotions. It is how we express ourselves without any boundaries. The written word is one of the most beautiful subjects to pick up on. It is natural. It is just another way of communication. I thank the reader and student for taking their time and effort to study what I have worked so hard for. The student and reader must realize that there are no laws when it comes to science. In reality, anything is possible and how one achieves the impossible becomes legendary. It is up to the student and reader to choose what they pick up when they touch the subject that is Dimension Fusion. This subject increases intelligence. The killer instinct has been demonstrated. Now without further ado, I present to the student and reader The Basic Fundamentals of Dimension Fusion.

Section I

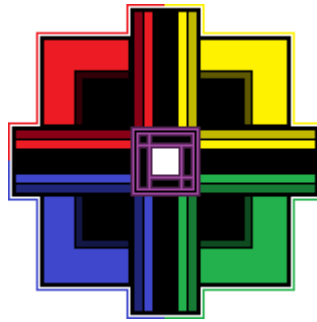

Literature

Literature

The Fragmentary Shape is the first of its kind and represents the Romans downfall. Anyone can tip over a Roman Column. The upright I (Roman Numeral 1) in this Fragmentary Shape

represents the Roman Column, the bottom I (Roman Numeral 1) is the fall of the Roman Column. The Common Loser. L is for Loser (Romans). When adding 2 Fragmentary Shapes L (FS) together the solution of the problem is referred to as *Ascension*. First Optical Dimension *Ascension* through an *Ascension Equation*; The *Ascension* is known as a Dimensional Shape (Ds). In Equation form the Square is *Sq2Ds*. A *Basic Line* (BL) added to another *Basic Line* becomes a Fragmentary Shape L. A fragmentary shape can resemble anything; This Fragmentary Shape resembles an L from the alphabet. The Fragmentary Shape L is just your average Incomplete Shape which is represented by The Fragmentary shape L. Two Basic Lines create the Fragmentary Shape L. Placing the Exponent (2) used by Mathematicians in problem-solving above the Fragmentary Shape L will appear as L². The 2 that sits above the Fragmentary Shape L² does not signify what is known in mathematics as “²” “Squared”. It simply means how many Fragmentary Shapes will be added. Fragmentary Shapes can be a simple line. Since letters cannot be multiplied the exponent above the Fragmentary Shape represents the base of the next Dimension. Exponent Representation will be used for Dimension Fusion’s Ascensions Equation Solutions. To perform a square one needs to align 2 Fragmentary shapes and they must be perpendicular, if they are not perpendicular there will be complications later if one is to advance into other Dimension of this subject. The 2 (²) above the Fragmentary Shape L has no significance towards any multiplication. 1 x 1 is 1. 1 has no power. The classic mechanic of addition is used for the First Optical Dimension Ascension Equation Solution; Multiplication leads nowhere when 1 multiplies itself by 1. There is no power in 1. The Common Loser. (Romans) The law of Mathematics is used for Dimension Fusion. In order for Dimension Fusion to be successful the mathematical law must be present and must correspond with the Constant and their rule. As a Step-Motherly hands-on form. Moving forward towards Exponent Representation Dimension Equations. If the mathematic rule of addition was used in this type of Mathematics; The First Optical Dimension would resemble Pi (π). Not the approximate, but 3.1415926... (Etc.) which makes no sense to me, to be honest. I have discovered that Einstein used π as a secret form of paying allegiance to a dictator. Einstein used equations to secretly write out plans for war. They are not Equations but are plans for War. This famous equation from the 1920s is of Einstein’s work, I added it to my Dimension Fusion to present my dominance over Einstein and his rule. The worship of ancient rule gets the worshipper nowhere.

$$F = 4\pi Y^2$$

Einstein pays allegiance to Adolf Hitler

The equation above is nonsense. It is none other than a secretive and fancy way of spelling Fuhrer. This was 1920. As you may have seen in the Preface of this read, I have calculated my own equations and statements so that Dimension Fusion becomes a great success. Einstein’s Equations are the most impressive forms of Secrecy. The Book of War that was Einstein’s is now Mien. The foolish equation above is from Einstein’s (Dumbass) famous book “The General Theory of Relativity” it is complete rubbish. Numbers have Laws. Each number. Laws of being. Which, I used to my advantage. Einstein used Numerology. I used it as well. Tipping over the I (Roman numeral 1). The perplexing formulas presented in Dimension Fusion, that revolve around Dimensions are without a doubt the first of its kind and increases the momentum of extensive intelligence growth. The Basic Fundamentals of Dimension Fusion keeps the subject in a step by step functionality. Leaving no confusion for the student and reader. The hands on approach of Dimension Fusion lets the student and reader study at a pace at their own will. In Dimension Fusion I eliminate the = sign. The = sign is a representation of Two Lightning Strikes

of the SS. Einstein failed to realize that e is the = sign. I will demonstrate below as Dimension Fusion continues to grow. The first letter of equal is an e hence why I have replaced the primitive symbol that is a representation of The Nazi's power = to /e/. The slashes are my Two Lightning Strikes raining down on Einstein. I have no need for primitive symbols in my advanced calculations. The acronym for the substitution of mathematics symbols is D.S.A.M.E for it is the same. Division (d), Subtraction (s), Addition (a), Multiplication (m) and Equals (e). The student and reader will be reprogrammed to a new world of advanced mathematics as discussed in the preface. X means to eliminate hence why I eliminated the x symbol in multiplication and replaced the x with an m. m means to multiply. In Dimension Fusion I will change the mathematic symbols from symbols such as + to Letters of the alphabet to stretch the mind of the student and reader. Stretching the mind of the student and reader will increase their comprehension of this subject and will increase the awareness and ultimately the intelligence. As the intelligence increases the sense of awareness also increases. We start with The First Optical Dimension 1D. The First Optical Dimension is Literature. Shown below is a Constant and the equivalence to the Constant. The equivalence of the Constant is 1. In Dimension Fusion I assist the student and reader with the solution in between the equation steps. Giving the step-motherly hands on approach, as this is new to science, the student and reader must breakdown The First Dimension in equation form. The necessity for an equation of Dimensions is to advance the conscious awareness of the student and reader.

1D /e/ BL

Basic Line

1D Equals BL. The e substitutes the = sign. Dimension Fusion has no need for primitive symbols. 1 is the Constant and the Variable is represented as BL Basic Line, and begins the development of a Fusion. In The Basic Fundamentals of Dimension Fusion we call this a Constant Variable; the Constant is 1, and the Variable is BL. A Basic Line; Alphabetical Letters. To excel above the Basic Line, 1D over BL needs to be put in equation form. Keep in mind that $1D = BL$. The numerical order will increase with the advancement of Dimensions in Dimension Fusion. Shown above is the Constant Variable. A Constant Variable is a numerical order (Constant/Integer) placed next to a Variable, we will see below a Constant Variable that begins with BL and becomes DS. Below the Constant Variable BL is placed in the equation below. The Constant remains while the Variable changes. When Ascension has been fulfilled the Variable will change as stated. Constants change with Ascensions. The Ascensions of Dimensions is met by Dimension Fusion and enhances development in the mind of the eager student and reader engaging into battle, the battles are the equations I have laid down for the student and reader to spar in.

(1D)/BL

Constant Variable

A Basic line added to the Numerical Order 3, creating the 3 above the 1D in the equation's solution displayed on the next page. The S next to the Exponent Representation ³ signifies the Sides added to the Ascended Dimension. Displayed on the next page is the equation that begins the Ascension of the First Optical Dimension. Be aware that the ^{3s} in the equation above the Constant Variable 1D is to state how many sides the First Optical Ascended Shape will be added.

$$\frac{1D}{BL} [a] 2 /e/ \frac{1D^{3s}}{BL}$$

First Dimension Equation Step one

Step one. (a) stands for Addition. Two Basic Lines create the Fragmentary Shape \perp^{90° . A Right Angle is formed and the degree that is 90 is placed above the Two Basic Lines. It is the base for the Sq2Ds or Square. When solving the problem, the student and reader will end up with the Square. The solution is referred to as The First Optical Dimension Ascension Equation Solution. The Second Optical Dimension. The ³ in the next equation is just an Exponent Representation Numerical Order. It is not an exponent. It represents the amount of Sides that is the solution. Basic Line (BL) Becomes (Ds) Dimensional Shape. The Letters cannot be multiplied. X is a Variable; BL and DS are Constant Variables depending whether or not they have numerical order, if no numerical order is shown it is just a Variable. \perp Becomes X. X is created by Two Basic Lines. With the help of the alphabet we place the X in the equation shown on the next page. The Constant and Variable remain the same and until the Ascension is achieved this is when we see the change in numerical order, Depending on the Ascension of the Dimension. The Constants numerical order will ascend and eventually meet the requirements of the Dimensions it ascends to. Below the second step for the First Optical Dimension is shown, the student and reader will continue to breakdown the equation that is Wilson Alzir Martinez. Step Two is displayed below.

$$X^2 \frac{1D^{3s}}{BL}$$

First Dimension Equation Step Two

Step Two. The Exponent Representation Numerical Order ² above Variable X represents the Ascensions Dimension. The First Optical Dimension Ascension Equation Solution, 2D, The Second Dimension. X² is 1 x 2. X is just a variable and X cannot be multiplied. It doesn't correspond with the laws of mathematics. X times X doesn't equal anything. Two lines crossing create 1 x 2. A Basic Line represents Length. BL in the equation is defined as Basic Line. Length creates the foundation which I have shortened as BL. Length or the Basic Line ascends to the Third Optical Dimension Representation. You may know it as 3D. 3D is the Second Optical Dimension Ascension. BL is a variable symbol used to set up the foundation of the equation that is to solve for the solution Sq2Ds (Square).

$$X^2 \frac{1D^{3s}}{BL} /e/ Sq2Ds$$

First Dimension Solution preview

The First Dimension is the most complex due to it being the *blueprints* and becomes part of the foundation of what makes up the body of every other Optical Dimension. Optical meaning relating to sight. It's the Genetic code of Dimension Fusion. Without the Basic Line [First Optical Dimension] one would not be able to see the pattern that would follow. The pattern that makes up the structure ascends the foundation and becomes the elevation that takes place after the prints are made. First Dimension, where the movements are from Left to Right. Left and

Right represent the Basic Line. One starts from Left and makes their way Right, vice versa.. *Sq2Ds* is formed by 2 Fragmentary Shapes. Fragmentary Shape \perp . Each line needs to be perpendicular to each other. Incongruent lines will be incompatible. The Basic Lines must be congruent. Four Basic Lines create *Sq2Ds*. Two Basic Lines create the Fragmentary shape \perp .

$$X^2 \frac{1D^{3s}}{BL}$$

First Dimension Equation Continued

The solution is *Sq2Ds*. The same measurements are needed for each side. Basic Lines must be congruent in My Dimension Fusion's mathematics. The Measurements must not be abstract. In a step-motherly fashion I remind the student and reader that X is a Variable. $1 \times 1 = 1$ meaning 1 has no power. 1 has no value. X is 1. 1 has no power. The number two is not an exponent. As a reminder I remind the student and reader that the number above the variable in the equations that I have laid out thus far are not exponents but *Exponent Representation Numerical Orders*. As stated before these reminders are as training wheels are to a bicycle; before one rides a bicycle as a child, the child must learn how to remain in balance. The Training wheels on a bicycle remains the child in balance. The Exponent Representation Numerical Order cannot multiply Variable X, therefore taking Variable X's Position in the equation. X means to eliminate therefore leaving the Exponent Representation ² to eliminate Variable X and replace Variable X. 1 multiplied by 2 equals 2 ($1 \times 2 = 2$). In multiplication the X that separates the 1 and 2 is eliminated after the solution is solved.

$$(1 \text{ m } 2) \frac{1D^{3s}}{BL}$$

First Dimension Step Three

Step Three. (m) stands for Multiplication. 1 multiplying its self does nothing. Dimension Fusion also states that 1 has no power. The Exponent Representation Numerical Order ³ is added to 1 becoming *Sq2Ds*. Now that the "Genetic Code" is completed we progress towards the First Optical Dimension Ascension which is none other than the complete shape. The equation shown above and below represent the steps for the ascension. When solved, the problem equals the Second Optical Dimension Ascension Equation Solution. *Sq2Ds* in My Dimension Fusion.

$$2 \frac{1D^{3s}}{BL}$$

First Dimension Step Four

Step Four. The solution of *Sq2Ds* is represented in its Dimensional Form. After the Four steps of The First Optical Dimension Equation is solved the solution is none other than the Dimensional Shape *Sq2Ds*. Four Perpendicular Lines make up the Dimensional Shape *Sq2Ds* as shown below. Four Steps is the equivalent to Four Lines. These lines must be congruent for the fusion of the four lines to excel and achieve mastery. The Perpendicular Polygon below is a Square. The shape is also known as a Quadrilateral.



Sq2Ds

Below I demonstrate what is known in Dimension Fusion as a shape in between the Ascension of the next Optical Dimension. The shape below is called a Sq2DsCu3Ds. It is a shape that is in between ascending from the Second Optical Dimension to the Third Optical Dimension. The Shape that is displayed below becomes what is known in Dimension fusion as the Cu3Ds. The Cu3Ds will be displayed in the Third Section. A glimpse of the student and readers future is demonstrated below. Not in its full form but a simple taste to what holds for the student and reader in the future of their studies that is Dimension Fusion.



Sq2DsCu3Ds⁶

2D3D

The shape above is called a 2 Dimensional *Cube*. The *Sq2DsCu3Ds* will make up the foundation and representation for the Dynamic of Color. The Basic line will create the Third Dimension in the *Sq2DsCu3Ds* and will advance the *Sq2DsCu3Ds*. The Basic Lines enhance the Dimension between The Second Optical Dimension and The Third Optical Dimension. The equation is displayed below. The Advancement of The 2D3D favors the Third Optical Dimension. The Basic Line enhances the visual and enhances the Three-Dimensional effect. My equation for the *Sq2DsCu3Ds* is displayed below.

$$\frac{1D}{BL} [a] 6s$$

First Dimension (1D/BL) plus (a) 6s (Six sides) is the equation that represents the *Sq2DsCu3Ds*.



$$\frac{1D^3}{BL} [a] \text{ Sq2DsCu3Ds}^6 / e / \text{ Sq} \frac{3Ds}{2Ds} \text{ Cu}$$

3Ds2Ds

The equation shown above represents the Basic Lines power, with Three Basic Lines the *Sq2DsCu3Ds* ascends to a Dimension between Dimensions. The Dimensional Shape above is called a *Sq3Ds2Ds*. A Third Dimensional Two Dimensional Shape. Above the Constant Variable 1D is shown with an Exponent Representation of ³. 1 x 3 = 3 hence why the Third Dimensional Second Dimensional Shape is shown with Three Basic Lines. This is a perfect example why it is imperative that The First Optical Dimension is mastered. With a step-motherly fashion I remind the student and reader in the next section that is *Mastery* of the First Optical Dimension and continue the process that is Dimension Fusion. It is with Mastery that the form of written

literature advances. The Sq2Ds will be the “Building Blocks” for a new Dimension of communication. Crimsonology will be discussed in Section 5. Crimsonology takes the Square and forms a new way of communication. The Square is the equivalent to Sq2Ds.



R2Ds

The Quadrilateral above is known in mathematics as a Rectangle. The Rectangle in Dimension Fusion is known as the R2Ds. The Sq2Ds + Sq2Ds - $\frac{1D}{BL}$ is the equation for the R2Ds. Two Sq2Ds are fused together and the BL Basic Line after the fusion must be Subtracted. The formation that is the Rectangle is the combination of 2 Sq2Ds. Shown below is the equation that will advance the Sq2Ds to another status. The Ascension of Dimension is not required. This is an advancement of lengths. The Advancement of the Square to become a rectangle is what follows.



$$[Sq2Ds [a] Sq2Ds] \$ \frac{1D}{BL}$$

First Step of R2Ds

Step one. The \$ Stands for Subtraction. Don’t be fooled by the symbol and think it is a money symbol, for the money has Two lines piercing the S. Notice only 1 line pierces the S. \$. I needed a new symbol to represent Subtraction. I cannot use s because s is displayed in the Shapes. The Line splitting the S in middle is the minus sign. The Sq2Ds is combined with a Second Sq2Ds. The Brackets in the equation above surrounding the two Sq2Ds represents the first step in the equation. The equation above reads as follows, Square plus Square Minus 1 Dimensional Basic Line. The fusion of the two Sq2Ds is the advancement of the Sq2Ds to another height of Dimension, although it remains in the Second Dimension. The advancement of the Sq2Ds cannot be denied. The result of the two Sq2Ds combined is demonstrated below.



$$Sq2Ds^2 \$ \frac{1D}{BL}$$

Second Step of R2Ds

Step Two. With the Sq2Ds’ fusion that required two Sq2Ds to combine create a new quadrilateral polygon. However, a Basic Line from the two combined quadrilateral polygons is formed creating a distance between each other therefore leaving the shape unidentified. Although the perimeter is identified as a Rectangle. The Area creates two sets of measurements. The subtraction of the Basic Line that was formed by the combination of the two Sq2Ds is needed to complete the solution that is known in Dimension Fusion as Sqr2Ds. The Exponent

Representation Numerical Order ² is subtracted by $\frac{1D}{BL}$ leaving one whole line creating the outline of the R2Ds. The Rectangle is formed and is displayed in the Quadrilateral Polygon below.



R2DS

The solution is a Rectangle. In Dimension Fusion this Rectangle is called a R2Ds. In Step Two the equation was $Sq2Ds^2 - \frac{1D}{BL}$. I remind the student and reader on how this 2Ds became to be. (2Ds is Two Dimensional Shape) The Exponent Representation Numerical Order ² is subtracted by the $\frac{1D}{BL}$. 1D/BL represents a Basic Line. The Basic Line created by the Two Sq2Ds' created a Basic Line that separates the Polygon; The Basic Line must be Subtracted. Below is the R2Ds². Reminding the student and reader how the solution came to be.



R2Ds²

The image above is the Two R2Ds combined. These 2Ds' when joined together create the Basic Line that separates the two. Hence why $\frac{1D}{BL}$ is subtracted from the Exponent Representation Numerical Order that is ². The First Optical Dimension is quite difficult to comprehend but as the saying goes “practice makes perfect”. At the end of this text booklet, the student and reader will review the Basic Fundamentals of Dimension Fusion. Practice does indeed make perfect, as I have practiced my own equations and have advanced with superior results. The student and reader will be reminded that Trial and Error creates the biggest impact in the learning process. With no Trial and Error, the student and reader will walk a path blind. With Trial and Error the student and reader will learn and take their time and put effort in their path as their path grows through their mistakes. Dimension Fusion is relatively new as a science and therefore lacks the rich background of knowledge already collected and digested that is available to the worker in the older sciences. I present facts in Dimension Fusion, therefore leaving the skeptics in the dust.

Section II



Mastery

Mastery

Prowling the plains of their The Royal Kingdom, the Lioness and Lion have begun their hunt. The Lioness and Lion make hunting the ruling mechanic. Hunting has made their strength increase. It cannot be identified. With the Law of The Jungle, the Lioness and Lion rule the Animal Kingdom. Brilliance and Agility is the classic mechanic used in their domination of what is rightfully theirs. B (Brilliance) A (Agility) is their rule in their kingdom that cannot be duplicated. With the rearrangement of the rule that was A and B in our reality, The Lioness and Lion have full control over this previous rule. The previous rule was Einstein. It was A and B, now it is Wilson. B and A; the ruling mechanic. The Basic Fundamentals of Dimension Fusion is without a doubt a tool of destruction that creates life to incomparable measures. Reprogramming Nations. Creating new layouts for “Future” architects. Geometry and Dimension Fusion are Two different worlds. You can say that this is the next step of Geometry. The “Blue Prints” are made up and accounted for. We move on towards reviewing the problem and breaking down for the solution of the Second Optical Dimension Ascension. The First Optical Dimension Ascension Equation Solution also known as Mastery. Since 1 cannot multiply itself by 3 for example 1 x 1 x 1, the laws of mathematics are needed to work it into an equation. There are laws in mathematics just like there are laws in science. 1 to the Third Power *Cubed* is impossible according the mathematical law. This is why Addition is used for the 1 and 3 in the First Optical Dimension Equation.

$$(1 \text{ m } 2) \frac{1D^{3s}}{BL} /e/ \text{ Sq}2Ds$$

First Dimension Solution

1 multiplied by 2 becomes the Dimension in the Solution. 1D³ is an addition problem itself and becomes the Dimension Sides of the Shape that the First Dimension Ascends towards. Letters of the Alphabet cannot be multiplied hence why the Variable is placed next to the Constant, it is just a representation of the Dimension. The Constant 2 that replaced the variable X becomes the 2 in 2Ds. The solution makes up the Dimensional Shape (*Ds*) *Square*.

$$2 \frac{1D^{3s}}{BL} /e/ \text{ Sq}2Ds$$

First Dimension’s Ascension to the Second Dimension

BL Basic Line is the Variable and 1D First Dimension is the Constant Variable, a Variable without numerical order has no power just as the Variable X does not in Algebra. It is a letter from the Alphabet. Letters have no rule in Mathematics; they are merely used as Variables. The First Equation was the most difficult to create because the First Dimension are Points L [Length] and H [Height]. There is no ascending beyond the basic L [Length] and H [Height] lines without mathematics. Skipping towards multiplication instead of addition with the help of fusing mathematical numbers and symbols it is able to ascend to the next Dimension; *Mastery*. To form any prism with Dimension Fusion, mathematics in addition form would create complications due to the fact that the equations once processed in one’s head and written down would form repetitive steps. It creates Insanity. Imagine creating a complex shape with even edges and even vertices with your imagination. A complex shape beyond the Quadrilateral Polygon.

$$X^2 \frac{1D^{3s}}{BL}$$

First Dimension Equation

Variable X in the equation has no value. The ² Exponent Representation above Variable X cannot multiply Variable X. Variable X is substituted by the Exponent Representation ² it is a constant and the Constant replaces the Variable. The numerical order 2 replaces Variable X. The Numerical Order is represented by the number that is above Variable X. Variable X could in fact be 1 but since 1 x 1 goes nowhere, I replaced 1 with a Variable making the breaking down of the equation that much simpler. 1 multiplying 2 equals 2. Making the first part of the equation. Step one is shown below.

$$(1 \times 2) \frac{1D^{3s}}{BL} /e/ Sq2Ds$$

First Dimension Step one

Step one. 1 can't use the exponent ³ "Cubed". Mathematic rule states that 1 multiplied by 1 will remain 1. The Constant 2 steps in the equation. Parentheses are used in the equation to demonstrate space in between the equation. Therefore no confusion will take place in the simplification of the equation. When the solution is solved (BL) the (Basic Line) ascends to (Ds) Dimensional Shape. Notice that Addition is used for 1 and D³ making it 1 plus 3. 1 plus 3 equals the 4 sides of Sq2Ds or "Square".

$$2 \frac{1D^{3s}}{BL} /e/ Sq2Ds$$

First Dimension's Second Step

Step Two. The parentheses around (1 x 2) that demonstrated space cancel out and become the 2D in 2Ds. (M) *Mastery*. Below displays the solution that once was The First Optical Dimension. The linear form of the First Optical Dimension is displayed in its magnificent glory. Presentation is key to perform such excellence. As I demonstrate in this read, my pre-possessing presentation attracts the attention of the student and reader and enables a comfortable setting as they stretch their mind and begin to learn new mathematics.

$$2 \frac{1D^{3s}}{BL} /e/ Sq2Ds$$

Linear Form of the First Dimensions Ascension

After using the mathematical laws that are necessary to achieve the solution of the First Optical Dimension Ascension's Equation. The Square is formed. Sq2Ds. The Ascensions solution is indeed the "Square", The First Optical Dimensions Ascension.





Sq2Ds

First Optical Dimension Ascension Equation Solution

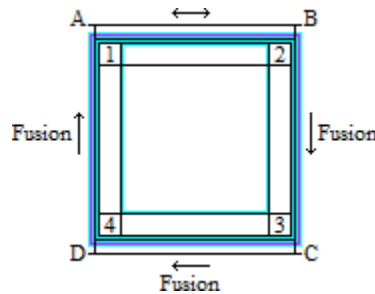
Performing the First Optical Dimension Ascension Equation Solution correctly the student will end up with the sum of The First Optical Dimensions Ascension. The sum of the First Optical Dimension Equation is the Square. Sq2Ds. Square is represented by a 2. Hence why in mathematics the power of 2 is referred to as a square. Points A, B, C and D must be perpendicular and must correspond with congruence. Point A begins the path towards Point B. Points C and D follow suit and fuses with Points B and A. 4 points in total. I've labeled each point with Constants for example: A^1 , B^2 , C^3 and D^4 . 1, 2 and 4 meet with congruence. 2, 3 and 4 also meet with congruence. The 4 points in perfect alignment create the outline of Sq2Ds. In the figure below I display the interruption of points A^1 and B^2 or First Optical Dimension; Points C^3 and D^4 intercept with perfect synchronicity. Point A^1 and B^2 are interrupted by the interception of Point C^3 and D^4 . The repetitive embankment that was A^1 and B^2 is interrupted as Points C^3 and D^4 enter The Railway system that was 1^A and 2^B . The interruption is met by My Railway Embankment that is 3^C and 4^D . The Fusion displayed below ends the repetitive cycle of 1^A and 2^B . Suppose that we do not interrupt Point 1^A and 2^B . The motion would remain in a repetitive back and forth cycle. The interception of A^1 and B^2 is a necessity that C^3 and D^4 must complete in order for interruption of the repetitive that 12 (AB) has created.



Interception of AB

The Diagram above displays My Fusion of III running towards Einstein's Relativity. A and B represent Einstein's Relativity while III represents Wilson's Dimension Fusion. The Second Optical Dimension I call Mastery. These equations will advance just like its predecessor. The Second Optical Dimension Ascension is known as Representation and will be picked up in Section III. Keeping the student and reader in a comfortable setting, they can read along these pages with ease and at their own pace. The more brilliant the calculations and more pleasant the presentation of the calculations, the higher the advancement of the student's intelligence and conscious awareness becomes. It is without a doubt the most pleasing understanding that I have noted thus far.  Colors in the next section will create a new atmosphere. These  Colors create Dimensions and labels the sides of the next ascension. I present Representation.

Section III



Representation

Representation

The measurements are completed and the framework is set up. We move on towards the Second Optical Dimension Ascension Equation and Solution. The student and reader will learn that two Sq2Ds^{3 1/2} shown in my next equations below completes the Cu3Ds or the “Cube”, we take what is called ³ “Cubed” or Exponent Representation and place it above Sq2Ds to represent how many sides the ascended fragmentary shape will have. I have labeled the sides with the Primary  Colors [Red 1.1](#), [Yellow 1.2](#) and [Blue 1.3](#). When the Second Ascension ascends to the Third Optical Dimension, the ³ takes the position of the Numerical Order in the Second Ascension and Ascends to 3D. The Third Optical Dimension abbreviation looks as follows, 3D. The student and reader will begin with the advancement of the Sq2Ds to its Fragmentary form. The Fragmentary Shape, Sq2Ds^{3 1/2} is labeled in the Primary Colors [Red 1.1](#), [Yellow 1.2](#) and [Blue 1.3](#).



$$\text{Sq2Ds [a] } 2s \begin{bmatrix} 1 \\ 2 \end{bmatrix} /e/ \text{Sq2Ds}^3 \begin{bmatrix} 1 \\ 2 \end{bmatrix}$$



Second Optical Dimension’s Step One

Step One. I have placed Brackets around the a. [a] is addition. Brackets in Dimension are commas to literature. The Brackets surrounding the fraction represent the two sides that are added to the Sq2Ds’ Fragmentary Form. The variable s represents the sides, while the constant 2 represents amount of sides that will be added to the Sq2Ds. The student and reader has learned that Sq2Ds = Square. The Fraction above is nothing more than another simple equation, 1 + 2 = 3 therefore placing the ³ Exponent Representation above the Sq2Ds. By adding 2 Sq2Ds’ to the original Sq2Ds, The Sq2Ds advances to the form that is shown below. Remember that 1/2 represents half of the Cu3Ds.



$$\text{Sq2Ds}^3 \begin{bmatrix} 1 \\ 2 \end{bmatrix}$$

Solution of First Step

The Fragmentary shape shown in the diagram above is Sq2Ds^{3 1/2}. $\begin{bmatrix} 1 \\ 2 \end{bmatrix}$ Represents half of the Cu3Ds (Cube). To perform the Cu3Ds (Cube), two Fragmentary shapes must align in perfect synchronicity so to speak and mathematical law will follow suit. Without the proper mathematic steps in Dimension Fusion. The Term Fragmentary shape will be infinite. Synchronicity will indeed be the balance in this subject. The student and reader must be aware that the Primary  Colors [Red 1.1](#), [Yellow 1.2](#) and [Blue 1.3](#) encoded into the sides of the shape are indeed two Sq2Ds^{3 1/2}. The Sides are labeled with the Primary  Colors [Red 1.1](#), [Yellow 1.2](#) and [Blue 1.3](#) to display how many sides there are and keeps the student and reader aware that there are Two Fragmentary shapes. The Fragmentary Shapes are Sq2Ds^{3 1/2}.

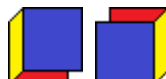

Fragmentary Shape Explanation

Sq means Square, Ds means Dimensional Sides, Dimensional Sides in a *Dimensional Shape* or Shapes. Two Dimensional Shapes become the sides of the Dimension that is Representation, hence the term Dimensional Sides or Ds. The First Optical Dimension has no Dimension. The First Optical Dimension creates the foundation for what we call Representation or 3D. The Fragmentary Shapes in the figure above are known as $Sq2Ds^3 \frac{1}{2}$. These two Fragmentary Shapes will be combined and the end result is a $Cu3Ds$. Cube. The equation form is shown in the Second Step.

$$Sq2Ds^3$$

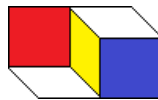

Second Optical Dimension Explanation

Brackets and Exponent Representation come into play once again. Brackets are just a Barrier as Literature is to Commas. No Confusion. Simplifying the equation into $2Ds^3$ which in turns puts the ³ “Cubed” in front of the next Ascension. After the solution of $2Ds^3$ is solved the Cubed Exponent becomes the Dimension. 3D is the solution of $2Ds^3$. The next Optical Dimension Ascension will have the “Cubed” exponent take place in the numerical order in Equation Solution; just as the exponent ² “Squared” took the Numerical Order in the equation. For Example, The 2 exponent representation above Variable X (X^2) replaced Variable X with numerical order. The numerical order 2 replaced Variable X. Hence 2D. The ³ in $Sq2Ds^3$ will replace the 2Ds. ³ is an Exponent Representation. $2Ds^3$ becomes 3Ds.



$$Sq2Ds^3 \left[\frac{1}{2} \right] m 2$$

Second Dimension Equation's Step Two

Step Two. The Second Step in the Second Optical Dimension Ascension's Equation Solution will look as the Fragmentary Shape above. The student and reader must learn how to read equations into shapes. The $Sq2Ds^3 \frac{1}{2}$ is the Fragmentary Shape above. The figure above is to remind the student of the Fragmentary shape $Sq2Ds^3 \frac{1}{2}$. Multiplying the Fragmentary Shape by two will create the shape which we refer to as the $Cu3Ds$. The Third Power in mathematics is known as Cubed. The *Cube* has six sides. Two times Three equals Six. The ³ Exponent Representation is multiplied by the 2Ds. which creates the six sides of the $Cu3Ds$. The $\left[\frac{1}{2} \right]$ presented next to the $Sq2Ds^3$ is one of the Fragmentary Shapes that is displayed in Step One. Two Fragmentary Shapes $Sq2Ds^3 \frac{1}{2}$ added together equal the Six Sides of $Cu3Ds$. Remember the Primary  [Colors Red 1.1](#), [Yellow 1.2](#) and [Blue 1.3](#) do not display any mathematics. The Primary  [Colors Red 1.1](#), [Yellow 1.2](#) and [Blue 1.3](#) are used to advise the student and reader of the Two Fragmentary Shapes.

$$Sq2Ds^3 \left[\frac{1}{2} \right] m 2$$



Second Dimension Equation's Third Step

Step Three. Second Optical Dimension Ascension Equation Solution is the *Cube*. Third Optical Dimension of the Square. The *Cube*; Two times Three equals the six sides of the Third Dimensional Shape *Cube*. In Dimension Fusion; Ascension of the Second Optical Dimension becomes a complete shape. (Note that the sides correspond with the numerical order given in the equation Two multiplied by Three is Six). With the laws of mathematics, the Square becomes a Cube. The Sq2Ds becomes a Cu3Ds.



Cu3Ds

Third Optical Dimension

The Second Optical Dimension Ascension is represented by 3. I refer the Third Optical Dimension as Representation. The Ascension of the *Square* is *Cube*. The Ascension from the Second Optical Dimension. The *Cubed* exponent is known as 3. Hence why we use the term “Cubed” when referring to the Third power of the exponent 3. The Optical Dimension that is known as Representation will advance just like its predecessors. The following figures below are the advanced forms of mathematics that reaches new heights and develops a new understanding of Dimension.  Colors will be presented just as before, but this time the  Colors will be added in equations. Observe below. The First Layer.

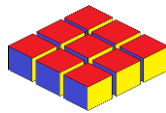

First Layer

The figure displayed above is the First Layer that creates The Cu3Ds Rubix. The equation is displayed on the next page. You can observe that the figure above resembles a 3 Dimensional Sq2Ds. Imagine having this figure in the form of blocks on your desk. Place the blocks so that all you see is the outline and the shape that the outline forms, the sidings do not matter in this visual. The outline would resemble a Sq2Ds. An example is displayed below for the student and reader who lacks the building blocks to present their own visual for themselves. Step one for the Solution that is Cu3Ds Rubix is presented on the next page.

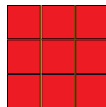

Sq2Ds' Dimension

Take note of the presentation of the First Layer in a Second Dimension. The example is for the student and reader who lack the blocks. The First Dimension is present; The Second Dimension is also present. The first step for the Cu3Ds Rubix is presented in the equation below. The equation is for the First Layer of the Cu3Ds Rubix.

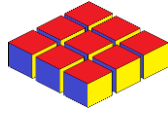

$$3\text{Cu3Ds (m)3 (a) } 1.1 \ 1.2 \ 1.3 \ \{\text{Pr}\}$$

The First Step

3 Cu3Ds Multiplied (m) by 3 Plus (a) 1.1, 1.2, and 1.3. There are a total of 9 Cu3Ds. The Constants in this equation are 3, 3 and 3. 3 Cu3Ds and 3  Colors Red 1.1, Yellow 1.2 and Blue 1.3. 3 Multiplied by 3 is 9. Hence why the amount of Cu3Ds' favors the Constant 9. Below is the First Layer of the Cu3Ds Rubix.

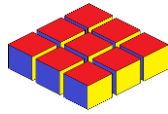

First Layer

Displayed below is the Second Step for the Second Layer that creates The Cu3Ds Rubix. Below is the mathematic equation for the Second Layer of The Cu3Ds Rubix. The laws of mathematics correspond to my equation below. The Constants in this equation are 3, 3, 3, and 2. 3 plus 3 plus 3 equals 9. 9 Multiplied by 2 is 18. Hence why The Second Layer has 18 Cu3Ds'.

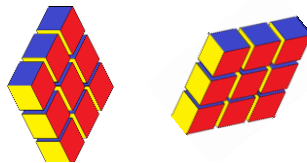

$$3 \text{ Cu3Ds (m) } 3 \text{ (a) } 1.1 \ 1.2 \ 1.3 \ \{\text{Pr}\} \ [(m)2]$$

The Second Step

3 Cu3Ds' Multiplied by 3 Plus (a) 1.1 1.2 1.3 Multiplied (m) by 2 Equals (e) The Second Layer of The Cu3Ds Rubix. The brackets that surround the [(m) 2] represent the last step to solve the equation of the Second Layer. 3 Layers forms the completion of the Cu3Ds Rubix. It is funny how there are only 3  Colors present in the Cu3Ds Rubix. 3 Sides are displayed in Three different Colors. 9 Sq2Ds for each side. 27 Cu3Ds are present in The Cu3Ds Rubix. The laws of mathematics correspond to my calculations. 3 Multiplied by 3 equals 9. 9 Multiplied by 3 is 27. On the next page I present to the student and reader the third and final step for The Cu3Ds Rubix. The Second step creates the Second Layer of the Cu3Ds Rubix. 18 Cu3Ds are present in the Second Layer. It corresponds with the law of mathematics for example: 9 Multiplied by 2 equals 18. 9 Cu3Ds' and 2 Layers. The 9 Cu3Ds' multiplied by 2 Layers equals the 18 Cu3Ds' in the Second Layer. I go into further detail in the next page.

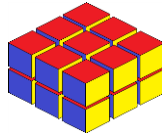



Second Layer

Observe there are Two Layers in the image above. 18 total Cu3Ds' are explained visually and mathematically. 9 multiplied by 2 is 18. The statement is true, 9 multiplied by 2 is indeed 18, but in this case the equation to solve for the Second Layer of The Cu3Ds Rubix has a more complex structure. Mathematic wise. The structure of the Second Layer can be broken down in a mathematic equation just as before. 3  Colors; Red 1.1, Yellow 1.2 and Blue 1.3, 3 Sides and 9 Cu3Ds'. 9 Cu3Ds' Multiplied by 3 equals 27. Hence why the next equation has the Three Constants; 3, 3 and 9. 9 Multiplied by 9 is indeed 27.



$$9 \text{ Cu3Ds (m) } 3 \frac{1.1 \ 1.2 \ 1.3 \ \{\text{Pr}\}}{3}$$

The Third Step

The equation displayed above is The Cu3Ds Rubix. 9 Cu3Ds (m) Multiplied by 3 (d) Divided by 3 Primary  Colors (e) equals My Rubix Cu3Ds. As I continue the creation of these calculations I am advancing my own intellect of conscious awareness of Dimensions. Through the studies of these calculations, I provide new equations for the student and reader to increase their own status of mathematics. These equations are new to the science community. It is a new science and therefore lacks the rich nature of literature. The student and reader has observed that Coloration fused with Equations create a more significant combination of shapes. The combination of  Colors in this section were 1.1, 1.2, and 1.3.

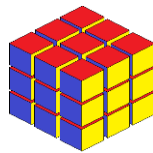

Cu3Ds Rubix

With the Coloration added to our equation the depth and nature of its predecessor evolves into a new form. The ascended Sq2Ds to the next ascension which is known in Dimension Fusion as The Second Optical Ascended Sq2Ds; The Cu3Ds is shown above. The Cu3Ds knows no boundaries as the advancement of its genealogy increases to new heights. The advancement of the Cu3Ds takes another form when the combination is precise. The Solution of the Equations Step One, Step Two, Step Three is My Cu3Ds Rubix. My Cu3Ds Rubix is displayed in the figure above.



The Ascended Basic Line

I call the figure above L. It resembles an L from the Alphabet. It displays the Addition of **Colors** with The Second Optical Dimension Ascension. The Third Optical Dimension ascends to another height when The Dimension of **Color** is added. The First Optical Dimension has ascended beyond the Basic Line. The Fragmentary Shape L which helped form the Sq2Ds is displayed in a phenomenal fashion. As you can see in the figure above the resemblance is that of the Fragmentary Shape L. With the law of Mathematics and My Dimension Fusion's Calculations I can enhance the depth of my Cu3Ds To another level. Below is the equation that forms The Ascended Basic Line. You can say it is The First Optical Dimension Ascension x3. For it resembles Two Basic Lines in a Third Optical Dimension. In the first section the student and reader learned about Two Basic Lines. Two Basic Lines plus the 90° create the Fragmentary Shape L.

$$\text{Cu3Ds [m] } 5 \text{ [a] } \frac{1.1 \ 1.2 \ 1.3 \ \{\text{Pr}\}}{6 \text{ Sq2Ds}}$$

Third Optical Ascension Coloration Equation

5 Cu3Ds' added with The Primary **Colors** form Depth. The Equation is: Cu3Ds (m) Multiplied by 5 plus (a) 1.1, 1.2 and 1.3 (d) divided by 6 Sq2Ds. The student and reader must remember that {Pr} represents the set of **Colors** that is added to the equation. The Solution is: The Ascended Basic Line L. The reason for 6 Sq2Ds' is to display the 2 sides that are shown by the 3 **Colors**. 6 divided by 3 is 2. Hence why you can only see Two **Colors** for each Cu3Ds that forms L. In the Diagram each Cu3Ds displays Two **Colors**, creating a sense of Depth for The Ascended Basic Line increasing the Dimension of the Diagram. Although the formation is in Fragmentary form the visual message is clear, I say the form is Fragmentary because the ends of these Cu3Ds do not touch. Visualize the image in The First Optical Dimension. The image displayed below resembles the Fragmentary Shape L does it not? Hence why it labeled as a Fragmentary Form. Each Cu3ds is made up of 6 sides, therefore the Constant 6 is used in the equation above. There are 3 **Colors** 1.1, 1.2 and 1.3. 1.1, 1.2 and 1.3. ½ is used for half of the Cu3Ds. 2 x 3 = 6. 6 Sides, 3 Colors and 2 Halves that create a Cu3Ds.



The Solution

The Third Optical Ascension Coloration Equation Solution is displayed in its form as it was first introduced. The demonstration of what **Colors** can create is displayed in The Third Optical Ascension Coloration Equation Solution. The **Colors** used in the demonstration above are the Primary **Colors**. The Primary **Colors** are Red, Yellow and Blue. 1.1 is Red, 1.2 is Yellow and 1.3 is Blue. The mechanics that is 1.1, 1.2, and 1.3 will be discussed later in the read, for now the observation of these mechanics can only be displayed how they are; meaning that the

student and reader can only awe at the mechanics that are 1.1, 1.2, and 1.3 for the discussion of these mechanics have not been broken down.



Rectangular Prism

The Rectangular Prism is called a 3DsPrsm in Dimension Fusion. The student and reader will define the Rectangular Prism as 3DsPrsm. Above the figure displays the Prism in its Optical Form. The equation that is needed to create this 3DsPrsm is displayed below. The figure that is Sq2Ds. The Second Optical Dimension Equation is displayed below. The Ascension from the Second Optical Dimension of the R2Ds is needed for the ascension that is called Third Optical Dimension.



$$[Sq2Ds [a] Sq2Ds] \$ \frac{1D}{BL}$$

3DsPrsm Step One

Step One. The equation above is Step One for the Ascension of the Second Optical Dimension Equation that is to solve for the R2Ds. To form the R2Ds also known as the Rectangle. Two Sq2Ds' must be added together and The Basic Line that is left after the fusion of the Two Sq2Ds' is subtracted from the solution. In Dimension Fusion the Rectangular Prism is called Prsm Rectangular. The Second Optical Dimension Ascension Equation Solution of the R2Ds continues below. The student and reader will retrace their consciousness as they continue to read and calculate these new mathematics that I have created. Visuals of the equation are displayed above the equation on the next page. Below continues with the subtraction of the 1D that is in the fusion the two Sq2Ds'. Remember that the fusion of two Sq2Ds' create one shape, the difference in the shape is displayed above the equation.



$$[Sq2Ds^2 \$ \frac{1D}{BL}] (a) 4s$$

3DsPrsm Step Two



Step Two. The equation above is Step Two of the 3DsPrsm. The solution for the 3DsPrsm is called a PrsmRectangular. The Exponent Representation ² above the Sq2Ds represents the Two Sq2Ds joined together. The $\frac{1D}{BL}$ is subtracted to create the solid Rectangle also known in Dimension Fusion as R2Ds. the ² is subtracted by $\frac{1D}{BL}$ leaving one whole line creating the outline of the R2Ds. The Constant Variable 4s represents the 4 parallel sides of the 3DsPrsm, PrsmRectangular will have. . The visual above the equation is a fusion. As you can see the fusion

of two Sq2Ds' has been displayed in a visual that defines the equation that is displayed for Step Two. The visual above the equation is a Fragmentary R2Ds. An incomplete rectangle.

The filling of Empty Space will be demonstrated on the next page. The Empty Space is filled with more calculations from Dimension Fusion. Displayed on the next page is the solution of Step One. Not the solution as a whole but concludes Step One.



3Ds4sPrsm

The Figure shown above is the solution of Step Two. The Ascension of the Second Optical Dimensional Shape R2Ds or also known as the Rectangle. The  Color  Ultimate 1 represents the Four Sides of the 3Ds4sPrsm. The Sq2Ds on each side represents The Empty Space that needs to be filled. As I have demonstrated in the previous equation 4s represents the 4 sides this solution will have. 2 Sq2Ds needs to be added to the equation to ensure that the 3DsPrsm PrsmRectangular becomes whole. The Shape displayed above is a called a Fragmentary Prism. By placing the Constant 2 next to the Sq2Ds the 2Sq2Ds is placed in the next Optical Dimension Ascension Equation. The Optical Dimension Ascension Equation is displayed below.

$$4sPrsm [a] 2Sq2Ds$$

3DsPrsm Step Three

Step Three. The 4s is a Constant Variable. The 4 is the Constant. The number 4 represents the amount of sides. While the s is the Variable. The s is placed next to the 4 to represent the sides that the constant displays. 4s reads as Four Sides of the Prism. This is what 4sPrsm stands for. Although the figure is Fragmentary Shape the name Prism still holds. Why does it remain "Prism"? The solution is a Prism therefore the name remains. The sides that represent Empty Space in this equation will be filled; Sq2Ds' are added to the 4 sided Fragmentary Prism. The Constant 2 placed next to the Sq2Ds represents how many sides will be added to the 4sPrsm. The solution is displayed below.



PrsmRectangular

The Rectangle also known in Dimension Fusion as R2Ds has ascended to its Third Optical Dimension. The Ascension of the Second Optical Dimension of the R2Ds becomes the PrsmRectangular. The Rectangular Prism/PrsmRectangular is displayed in its Ascended Optical Dimension from its previous state. The previous state is shown below. When I speak about the previous state I am discussing the state before the ascension that the Optical Dimension ascends to. In this example the previous state of the PrsmRectangular is the R2Ds displayed below.



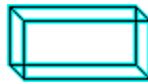

R2Ds

The R2Ds is in its Second Optical Dimension. The Ascension is complete and has displayed in equation and optical form. The 2Ds ascended to a 3Ds. The Third Optical Dimension Ascension of the R2Ds is PrsmRectangular. The Ascended Dimension of the R2Ds is the 3DsPrsm Displayed below. The Rectangular Prism. As a reminder I remind the student and reader that in Dimension Fusion the Rectangular Prism is known as PrsmRectangular.



PrsmRectangular

The student and reader have now read the foundation of what The Basic Fundamentals of Dimension Fusion is about. The student and reader have been given equations and steps on how the equations are solved. The following sections in this text booklet will continue the path of excelling the student and readers depth perception and will increase their consciousness and awareness. Dimensions will be discovered as the read continues. From the Basic Line to Inter-Dimensional Travel, these mathematics and calculations will increase the intelligence of mankind. Strategic calculations are the foundation of the build that is Dimension Fusion.  Colors will strengthen Dimension Fusion's foundation and its structure. A new world awaits the student and reader as I present  Color Mathematics and Numerical  Color Equations. Relatively new The Basic Fundamentals of Dimension Fusion advances the comprehension of life.

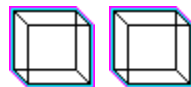

Cu3Ds (a) Cu3Ds

Detour

Step One. The equation above is another strategy for PrsmRectangular. With precision, the advancement of the R2Ds finds itself in another formation. The necessities for this PrsmRectangular equation are two Cu3Ds'. Addition creates the next step.

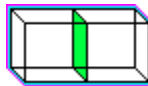

$$Cu3Ds'(\$) 4 \frac{1D}{BL} (Sq2Ds)$$

Step Two. Two Cu3Ds' are combined and the solution is displayed above. Addition was used to created the solution above. 4 BL has been placed in the solution. It is my right as the creator of Dimension Fusion to subtract the 4 Basic Lines. 4 Basic Lines create the Sq2Ds. The Sq2Ds that

was created by the combination of two Cu3Ds' is displayed in the  Color format [Green 2.2](#). The subtraction of the [Green 2.2](#) Sq2Ds gives me the solution PrsmRectangular.



PrsmRectangular²

Solution. Subtracting the [Green 2.2](#) Sq2Ds results in the Prsm given above. This strategy of adding two Cu3Ds' gives me another route to the PrsmRectangular. It is PrsmRectangular². The ² above the name states the position of the PrsmRectangular.



Reverse Simplification

To Reverse Simplify the student must add an Sq2Ds. the following figure below is the first step for Reverse Simplification.

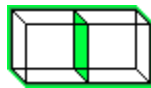

$$\frac{Sq2Ds}{1} \left(4 \frac{1D}{BL} \right) a PrsmRectangular$$

By adding 1 Sq2Ds to the PrsmRectangular, the PrsmRectangular begins to Reverse Engineer its mechanic. Reverse Engineer is defined as the reproduction of a product following detailed examination of its construction or composition. As you can see the Sq2Ds has made its back into the equation and figure.

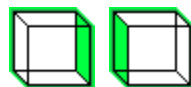

Sq2Ds [F] PrsmRectangular

Fission is displayed as the Sq2Ds splits itself into two Cu3Ds'. Fission is defined as the action of dividing or splitting something into two or more parts. F represents Fission. Who says the term Fission can't be used in basic mathematics such as Dimension Fusion. With Fission (F) the PrsmRectangular has now found its way back in its first state. Two Cu3Ds' were used to form the PrsmRectangular².



1PrsmRectangular⁴

The figure above is the PrsmRectangular ¹/₄. The Equation for this figure is displayed on the next page. With excellence I continue Dimension Fusion as a whole.

$$\frac{R2Ds}{[a]Sq2Ds} PrsmRectangular /e/ [F]$$

One two dimensional Rectangle (R2Ds) plus [a] one two dimensional Square (Sq2Ds) plus [a] PrsmRectangular creates subtraction. The two dimensional shapes added to the three dimensional shapes subtract space given for the PrsmRectangular. Displayed below is the formation of the two dimensional shapes before subtraction. Fission separates the PrsmRectangular.



Subtraction Addition

With the Addition (a) of the two dimensional Rectangle (R2Ds) and the two dimensional Square (Sq2Ds) Subtraction comes into play. Below is displayed the Addition of the two dimensional Rectangle to the PrsmRectangular.



Addition of R2Ds

By Adding a R2Ds (Rectangle) to the PrsmRectangular, space is divided into two sections. The two dimensional shape R2Ds creates two sections in the PrsmRectangular.

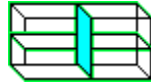

Addition of the Sq2Ds

Addition creates subtraction. In Dimension Fusion I add two shapes to create one shape. Subtraction from Addition. The Sq2Ds and the R2Ds creates four sections in the PrsmRectangular. Fission (F) separates the PrsmRectangular. The solution is displayed below.



1PrsmRectangular⁴

The PrsmRectangular $\frac{1}{4}$ is displayed above. Don't mind the quantity. Depending on its size, the PrsmRectangular $\frac{1}{4}$ resembles a whole PrsmRectangular. Below is the PrsmRectangular $\frac{1}{2}$.

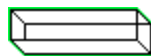

PrsmRectangular $\frac{1}{2}$

The figure above is another form of the PrsmRectangular. The equation is displayed on the next page. The PrsmRectangular is created by subtraction. As displayed on the next page.

$$[a] \frac{R2Ds}{1} PrsmRectangular/e/ [F]$$

Fission One

One R2Ds plus [a] PrsmRectangular equals (e) Fission. With Fission the PrsmRectangular splits into two. A symmetrical shape none the less the size of the PrsmRectangular becomes smaller in size but with congruence in its image.



Subtraction Addition

In Dimension Fusion Addition creates Subtraction. Not that it wouldn't in any other mathematics, but I'd say this is its correct position for the mean time. With the Addition of one two dimensional R2Ds (Rectangle) the PrsmRectangular is split into two sections.

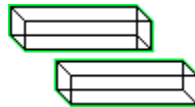

Fission Two

By Adding a R2Ds (Rectangle) to the PrsmRectangular, space is divided into two sections. The two dimensional shape R2Ds creates two sections in the PrsmRectangular. With the Addition of one R2Ds (Rectangle) the PrsmRectangular becomes smaller in size. Fission splits the PrsmRectangular into two whole shapes. Below is displayed the PrsmRectangular^{1/2} as a whole.

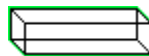

PrsmRectangular 1/2

The PrsmRectangular has had its size decreased by Addition. The PrsmRectangular is whole, therefore the lengths of the PrsmRectangular stay the same. Depending on what measurements is used, but in reality it is the same size. Lengths in Dimension Fusion is nothing but an illusion.



Symmetrical Innovation

It is my understand that my superiors for some reason have skipped the art of symmetry. Before there are Lengths, Widths and Heights measured the formation of a polyhedron must be created. If there is no symmetry, then the Lengths, Widths and Heights become obsolete. The measurements would be considered useless. The art of symmetry is considered in my experience a professions workshop. I as the professional in this subject create Symmetrical Innovation (SI). Symmetrical Innovation takes one side of the formation and mirrors the formation from one side to the other. Inversion must be comprehended before taking part of Symmetrical Innovation.

Inversion is defined as a reversal of the normal. The following diagrams explain Symmetrical Innovation.



Vertical and Horizontal

Step one. The figure above demonstrates the first step in Symmetrical Innovation. While creating the fragmentary shape above, the inverted side of the fragmentary shape follows suit. In a mirror effect (Inversion).

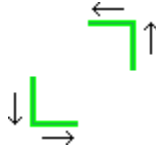

Vertical Symmetrical Innovation

Step two. A second portion of the shape that is being created is formed by an Inversion. For example. Take two pencils at hand and place them on a sheet of paper. With one pencil draw vertically downwards, while the first pencil ventures downwards, the second pencil makes its way vertically upwards. The Inversion state of up is down. Vice versa. When the first stage of Vertical Symmetrical Innovation is complete then comes the next step. Horizontal Symmetrical Innovation. Left and Right.

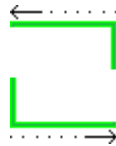

Horizontal Symmetrical Innovation

Step three. The inverted position taken from Left is Right. The figure above displays Horizontal Symmetrical Innovation. As you can see the two pencils (Arrows) stay in synchronicity. The formation of Symmetrical Innovation makes its way back towards a Vertical Symmetrical Innovation. Vertical Symmetrical Innovation is displayed below. It creates completion.

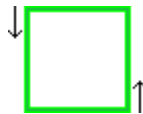

Symmetrical Connection

Step four. The formation of a polyhedron is created by symmetry. The connection between beginning and end is met at a point in which the lines of symmetry become whole. The measurements of a polyhedron come next. It is my understanding that I as a child was never taught Symmetrical Innovation. Seeing that I just created Symmetrical Innovation. The completion of the polyhedron is displayed below.

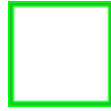



Symmetrical Innovated Sq2Ds

My Dimension Fusion places the missing steps in education as a whole. Before we are taught Length, Width and Height we as the student body should have learned Symmetrical Innovation.



Sqr2Ds [m] Sqr2Ds

3DSqr2Ds Equation

Sqr2Ds Multiplied by (m) Sqr2Ds. The reason I use multiplication in these equations is because these shapes develop multiple sides which cannot be identified by an observer. Multiplication is just a reminder that these shapes although resemble the Second Dimension is indeed in the Third Dimension. With the ascensions of Dimension the Sqr2Ds can ascend to another form that displays the Third Dimension, It is a Dimension in between Dimension such as the Sq2DsCu3Ds that was discussed in the first section; Literature, The Dimension is a Two Dimensional Three Dimensional Shape. The figure that the equation produces is displayed below. The  Colors that are displayed in the figure are  [Ultimate 1](#) and  [Seismic 2](#).







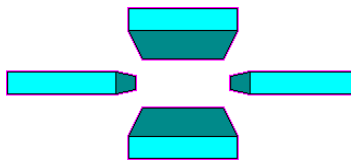



3DSqr2Ds

With the ascensions of the First Optical Dimension and Second Optical Dimensions, The Third Optical Dimension displays a new visual for the student and reader of Dimension Fusion. Depth is now involved in Dimension. The figure above is a Three Dimensional Sqr2Ds. I call this figure a 3DSqr2Ds. It is a Three Dimensional Sqr2Ds.  [Ultimate 1](#) and  [Seismic 2](#) enhances Dimension. The Figures below resemble a platform.









Depth

Platform is defined as a raised level surface on which people or things can stand. The image displayed above is a demonstration of Depth. Notice that the Four Three Dimensional Squares create a path that looks as if you can jump right on top of them. The Second Optical Dimension's Ascension also known as The Third Optical Dimension displays Depth. Depth is defined as the distance from the top or surface to the bottom of something. This figure above is an original and displays the sequence of Dimension that creates a new path that the student and reader can visualize. I have observed that my  Colors that I have chosen for my demonstrations  [Ultimate 1](#) and  [Seismic 2](#) increases the Depth perception and creates an illusion in which the shapes almost seem to pop out of the book and grasp the student and readers attention. The

reason these  Colors enhance Dimension is because these each of these  Colors are in fact multiple  Colors in 1. As you have observed each shape that I have presented displays the  Colors  Ultimate 1 and  Seismic 2.

$$Sq2Ds [m] Sq2Ds$$

$$\underline{3DSq2DS}$$

The equation above forms the figure that is displayed below. Sq2Ds multiplied by Sq2Ds equals the 3DSq2DS. form displays  Ultimate 1 and  Seismic 2. The coloration of the 3DSq2Ds is  Seismic 2 and the outline of the 3DSq2Ds is  Ultimate 1, as I stated a in the previous paragraph  Ultimate 1 and  Seismic 2 create Depth. Amazing how two  Colors can create another Dimension. I outline each shape that I create so that the student and reader can feel the depth without the use of their hands. They touch with their eyes not with their hands. This read enhances the depth perception of reality and reprograms the student and readers mind. The intelligence level increases with every flip of the page. Take a look at the visualization as you begin to walk deeper in the rabbit hole.

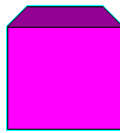

$$\underline{3DSq2Ds}$$

The Figure above is a Three Dimensional Sq2Ds (Square). The Dimension this figure is displayed in is the Third Optical Dimension. The solution for the equation is displayed above. As simple as it may seem the optics in this form can fool the mind of whoever comes across with it. How so? Well, to an observer who has no perception of what Depth is they only see a Square and a Trapezoid. Little do they know that that Trapezoid is indeed another square or the Sq2Ds. If observed from the top the observer will soon find themselves in a correction of their failure to comprehend the Dimension that is displayed in this figure.

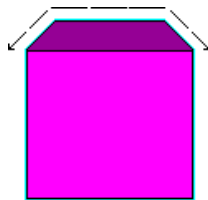

$$D +$$

$$\underline{\text{Depth Positive}}$$

Depth Positive Is displayed in the figure above. The formula for Depth Positive is D^+ . What is Depth Positive? Depth Positive is the Dimension that the Shape presents. The Profundity of the figure displays an outward presentation. The lines display the motion of the presented figure. By motion I mean the visual in which the figure displays. Seeing that it is a Three Dimensional Object without Empty Space. The student and reader will find themselves only focusing on

Dimension. For there is only Dimension being displayed. Hence why I call this strategy of observation Depth Positive.

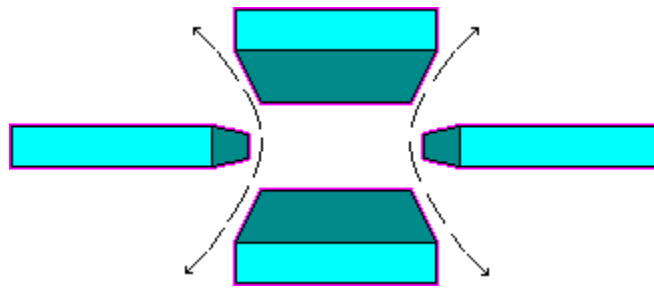

DN

Depth Neutral

Depth Neutral is displayed in the figure above. The formula for Depth Neutral is D^N . What is Depth Neutral? Depth Neutral is the Empty Space and Dimension that the figure presents. Dimension is Positive and Empty Space is Negative, hence why it is Neutral. Dimension and Empty Space cancel each other out, leaving neither negative nor positive. The lines in the figure above defines the Empty Space that is in and around the figures. The example above displays both Dimension and Empty Space. The focus of this observation of figure is both Dimension and Empty Space. The eyes tend to focus on not just the Dimensional Shapes, but also the Empty Space in between the Dimensional Shapes. This figure displays what the traveler of Inter-Dimensional travel sees before traveling. This is a path of Inter-Dimensional Travel.

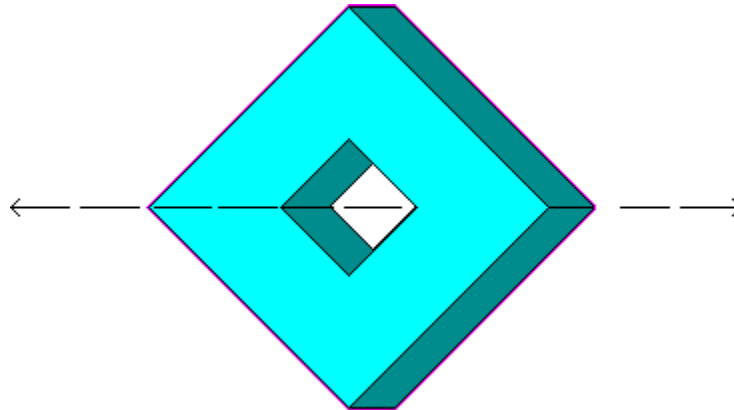

D -

Depth Negative

Depth Negative is displayed in this figure. The formula for Depth Negative is D^- . What is Depth Negative? Depth Negative is the Empty Space that the Figure displays. The Figure displays Empty Space; it almost feels as if you can reach inside the path that the figure presents. The Empty Space creates a path, As if you can walk right through the figure. The line running through the figure displays the negative aspect of the figure. Hence why I call this figure Depth Negative. There is no mass in the path only Empty Space. Although Dimension is displayed, Empty Space has found its way into the main focus. In this observation you can see that Empty

Space is found in the middle of the figure. Hence why this figure is called Depth Negative. The eyes focus on the empty space that the figure displays more than the Dimensional Shape. The figure above displays the path in which the traveler of Inter-Dimensional Travel will venture into. The Empty Space that is represented by D. Without the instructions of Dimension in a proper manner as I have demonstrated for the student and reader there would be no space travel. Inter-Dimensional Travel will be discussed in Section XIII.



The Elongation of Dimension

The Illusion of Length and Width create The Elongation of Dimension. The Illusion is displayed in a different form than the apparent presentation from a different angle. The Sides of the image are stretched so that the formation of The Illusion is present for the observer. However, depending on the angle where the observer is observing creates the presentation is displayed. The Image displayed below is The Illusion that the Elongation of Dimension presents for the observer who observes at the correct angle. It is not abstract. It is a matter of angles.

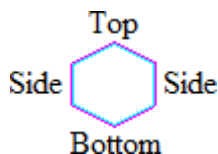

The Illusion of Dimension

The Cu3Ds displayed in The Elongation of Dimension looks rather incomplete. How? The image in reality must be observed from a different angle. Then and only then will the Elongation of the image become what it intends to display. The Illusion of Dimension displays The Cu3Ds. Only when the Elongated image is broken down with angles from the observer will the Cu3Ds form its Illusion. In the next Section the student and reader will learn the Mathematics of Basic Physics that is **Color**. Einstein's Special and General Theory of Relativity was nothing more than a book of War. The book discussed the Railway Systems that World War I and II the Nazi used in order for a victory in the Wars. My Cu3Ds has placed a halt in their Railway Systems. The Modern age that we live in has been defined from the classic mechanics that were placed after World War II. Einstein's Special and General Theory of Relativity was laid out in three parts. Part I, Part II and Part III. This literature known as The Basic Fundamentals of Dimension Fusion is the interception that puts a halt on Einstein's Part III of The Special and General Theory of Relativity. With a flip of a switch the M in Mechanic has been flipped upside down, The M becomes the W. The W is the W in World War III (notice the III creates a W, WWW is in play). II might create a V, but remember W is created by III. I have demonstrated before how the mechanics of Einstein ruled and created our world in the favor of his party. Now that Einstein's railway embankments have been interrupted, I, Wilson Alzir Martinez have devised strategic plans for World War III in the favor of the Americans; I am included, for I am an American. Third time's the charm is how the saying goes and this is the Third War that America will be in, I have gained the advantage in a strategic form. With The Destruction of The Space-Time Continuum I have created calculations to which the winners of World War III are the Americans. The leaders of the world do not pay attention to peasants. I am the peasant whom

they know not of. The Dynamic of  Colors is Section IV. With no further introduction I present the student and reader Section IV. The Dynamic of  Colors.

Section IV



Dynamic of Colors

The Chameleon has awoken and is ready to start its day. With a stretch of its tongue it aims at the fly buzzing aimlessly. Rustle in the branches above made by The Chameleon, The Viper makes its way towards the vibrations. The **Colors** given by heat from the Rodents nest, The Viper's sense of sight leads his journey that was once upwards into a slight detour underground. The hungry viper makes its way into the nest. The unsuspected family of rodents was surprised to learn that what has made its way into their domain is not a cousin but a different species that reins royal in the kingdom. I am the Hueman teaching the Human. I am making my literature colorful because since children we were fed chocolate and chocolate is a drug. Believe it or not you think like a child subliminal. This has been a fight between Einstein and I. I have broken-down his Space-Time Continuum and have placed the Checkmate with my Fusion. I discovered what Einstein's layout became from what was "A" and "B" in his Special and General Theory of Relativity; it evolved into numerology and symbolism. Ultimately creating wars between races. 12 is the advanced form of "AB" which has been ruling everything from basic measurements such as inches in a foot, 12 months in a calendar, 12 grades in grade school, 12 tribes of Israel, 12 Apostles of Jesus Christ, 12 Step Program in NA and AA groups, Zecharia Sitchin speaks about a 12th Planet (how convenient the number 12 is discussed about a such remarkable discovery) and the list goes on and on. Einstein's layout was superbly done and as seen in the Preface I have demonstrated the many uses that MC played out in life. "MC" is not Mass x Velocity but is indeed "Mushroom Cloud." When we place a ² next to MC it becomes Two Mushroom Clouds. "Fat Man" and "Little Boy" were Two Atomic Bombs that were dropped on Japan in World War II. "Little Boy" was dropped on Hiroshima creating One of the Mushroom Clouds from Einstein's Calculations $E=MC^2$. Nagasaki's Fate was met by "Fat Man". These Two Atomic Bombs create the MC^2 in Einstein's Equation $E=MC^2$. $E=MC^2$ should have read Einstein Equals Two Mushroom Clouds. These Masonic men who had been ruling during Einstein's time were foolish and illiterate therefore keeping the secrecy that was $E=MC^2$ was an ingenious plan. These men that he worked for in America were illiterate, for they didn't know how to spell or read. Classic Mechanics is what has been used to keep symbolism in play. $E = MC^2$ is nothing more than modern Hieroglyphics as I have stated in the Preface. During the late 1800s (1888 being the oldest video to date) to the 1950s video was released in **Black 4.9** and **White.0** We all know that the Two **Colors** **Black 4.9** and the **Color** **White .0** sum up to equal **Grey 4.8**. It seems that these "Grays" evolved with the mechanics that are **Black 4.9** and **.0 White**, and $E=MC^2$. **Black 4.9** and **.0 White** equal **Grey 4.8**. Jumping into the "Future" in our endless back and forth journey that Few Tour (ha-ha get it, the pronunciation of future sounds like Few Tour.) it is my understanding that these so-called Gray Beings that hover aimlessly above our heads are and correct me if I'm wrong but a manifestation of Einstein. Knowing that beings that observe tend to be attracted towards intelligence copy and create ideas from the intelligent being. And place their creations in our reality as a thank you. Now I'm trying to figure out why and how these Two relate. Indeed they do. But the Question is why and how. Viewing a television broadcast from the 1950s around when Einstein helped win the battle of World War Two. You will notice that no **Color** has made its debut on any television set, the broadcast would only be broadcasted in **Black 4.9** and **White.0**. The "Future". I believe from that era the Grays Reigned and copied the tactics of the Germans with kidnappings and experimentations. After the Crash of Roswell which was none other than the ultimate statue for Einstein's men. (Ultimate statue meaning my children made Einstein's children crash. The saucer that crashed is to show who dominates who.) Then came the **Color** on Television. If it weren't for I, we wouldn't have **Color** television. We would still be watching **Grey 4.8**.

Television. Some of these beings move through Dimensions. Seeing this actually happening here is a quick exercise to see these beings in action. Using your peripheral. It can be done at any time of the day. While viewing anything whether it being your computer, magazine notice through your peripheral you will see beings moving around you as if they are observing your every move. The peripheral is a Dimension. Jumping into the "Present". There is an abundance of [Colors](#) in our [Color Spectrum](#). The Dynamic of [Colors](#) completes the immobilization of the rule that once was, Secrecy was the rule and this rule has been the most known unknown rule that has been the foundation for their empire. The knowledge of [Colors](#) has been able to help us survive throughout the centuries. They have been used for warnings, dangers and a means to maneuver traffic. Since ancient times colors have helped us maintain safety through the notion of cautions and warning signals. A perfect example: ([Colors](#) are the basics of Physics) these so called "Genius" men and women in the past created a system in which [Colors](#) of the "Rainbow" [Red 1.1](#), [Orange 2.1](#), [Yellow 1.2](#), [Green 2.2](#), [Blue 1.3](#) and [Purple 2.3](#) represent homosexuality. There are two [Colors](#) that represent Two Mafias. One Mafia is called Velvet Mafia and is represented with the texture label Velvet, there is also a [Color](#) called [Velvet](#), The Second Mafia that is represented by a [Color](#) is called Lavender Mafia and is represented by the [Color](#) [Lavender](#). I watched a video that confirmed the Gay Mafia; 60 year old men are the heads of the Gay Mafia. This means that every Hollywood celebrity and politician that is 60 years old is Gay Mafia. The Rupert Report is where I got the confirmation on who the Gay Mafia consisted of. I believe Robert De Niro is a head of the Gay Mafia. He starred as a Don in The GodFather; Al Pacino is also a head of Gay Mafia. These men play roles that correspond to themselves.



John Connally

Notice John's name is spelled with the word Ally discretly hidden. This is a form of communication with the secret masonic order that informs the order of his role. Hence why his name is Connally. His family member Jennifer Connally was filmed being prostituted by several males in a movie called Requiem for a dream. This movie displays Jennifer Connally (notice the difference in the name Connally and Connelly, either way it goes they are related.) in a

prostitution setting with males. The males force her to stick a double headed dildo in her rectum as the males yell the word “Cum” repeatedly. This was filmed and was most likely used as a strategy to start more beef with the families of the mafia. It was most likely Connally’s families doing to act like victims. Conally’s family is tight with the government. The image displayed below is Jennifer Connally.



Jennifer Connally

This film displays an innocent women being prostituted by at least 30 men. While the directors roam scotch free. Notice the name Connally. It is a strategy these people use. They play victims while using their own family members with the same last name. No matter how it is spelled. They are related. Might I add the surname De Niro is the worst way to spell money. It has got to be the worst fake last name in history. A question. Why in the world would you misspell a last name when the last name is supposed to keep you incognito to the world. Obviously Robert De Niro has no Time Machine so this man in the midst of Jackie Kennedy and John Fitzgerald Kennedy must be a blood relation to Robert De Niro. Notice the resemblance of the two. Displayed on the next page is an image of Robert De Niro whos genetic code reads identical towards the man in the previous page. Genetics doesn’t lie. It is a code which remains silent.



Robert De Niro

Now, I know this motherfucker doesn’t have a Time Machine. I know for god damn sure he doesn’t know about Inter-Dimensional Travel. Motherfucker displayed above can’t even spell money correctly. Money in Spanish is spelled as Dinero, not De Niro. The foolish man rearranged the I and E. It went from Dinero to Deniro. Notice the I and E. the silly rule of I

before E except after C doesn't count in this bullshit. This man's family is in a lot of trouble starting today. (11/10/19)

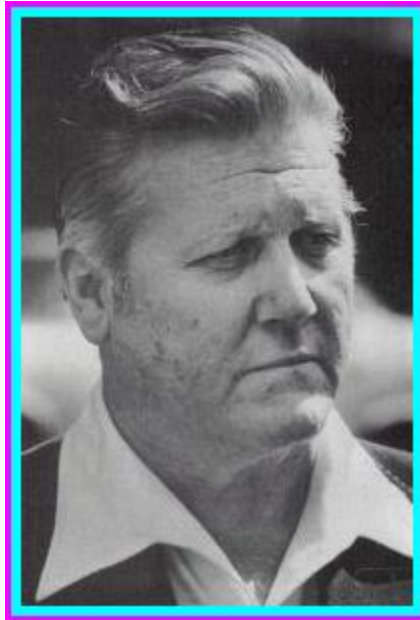

Frank Sheeran

A Mafia member hitman related to John Fitzgerald Kennedy is displayed above. I remind the student and reader Genetics don't lie. It is a silent code. Frank Sheeran was an Irishman, so was John Fitzgerald Kennedy. John Fitzgerald Kennedy found himself in a wrong position with his family, the Irish Mob in due battle with another Mafia organization Frank Sheeran killed Jimmy Hoffa. Jimmy Hoffa was close knit with the Mob. After Kennedy was assassinated, Kennedy's family member Frank Sheeran killed Jimmy Hoffa. Jack Ruby owner of the nightclub called Carousel Club (C², notice the C² in the name Carousel Club. E=MC² has made its way into organized crime.) was also closely knit with the Chicago mob. The assassination of Kennedy was linked to Mafia members and Lyndon B. Johnson. The Vice President that was sitting next to John Fitzgerald Kennedy during the presidency. Anyone that starred in Mafia movies are Gay Mafia. It's that easy to comprehend what cult these men are in. They display themselves for the world to see them and their damn proud of it. There are different sections of the Gay Mafia, The Gay Mafia, Velvet Mafia, gay lobby, Lavender Mafia, Homintern. Harvey Levin also confirmed The Gay mafia and stated that they can make or break a candidate. A musician by the name of Too Short explains that marriage between Gays is for Marital Benefits. The use of the term Homosexual is a psychological tactic used in modern warfare to not only dumb down a nation but to weaken a nation. This psychological strategy that is homosexual and transsexual leaves a wide open shot for a tactic that was used by the C.I.A. in the 50's and 60's. The strategy of cross dressing leaves an open shot at men and women from secret organizations to enter any location they please. The reason I believe Kennedy was killed is from his families Equation. I believe the murder was due to a scientific discovery that took place before John Kennedy was born. George FitzGerald an Irish Physicist partnered with Lorentz and created a hypothesis that changed science. They used the Mafia to rid of the power of FitzGerald. There is a reason why John Fitzgerald Kennedy spoke about Space exploration, there is also a reason why there is a Kennedy Space Center. It is due to George FitzGerald's creation of the Lorentz-FitGerald Contraction. The Hypothesis is the real reason why John FitzGerald Kennedy's family was removed from

office. It was due to a scientific discovery that lead The FitzGerald's into office. John Kennedy bore the surname FitzGerald. Below is the hypothesis that goes beyond the mafia. Remember this is not a Mafia murder, although they did commit the murder. This story branches into the scientific community. I am the holder of this information and I am the only person who has placed the murder of John FitzGerald Kennedy in the Science community. The assassination took place in 1963. Notice the image below is from Einstein's Special and General Theory of Relativity. FitzGerlad's name is displayed on this page, the page number is 63. X II is also displayed in this page. Could it be possible that this page is a direct message to assassinate John FitzGerald Kennedy. I have found myself in the midst of The Equation Wars.

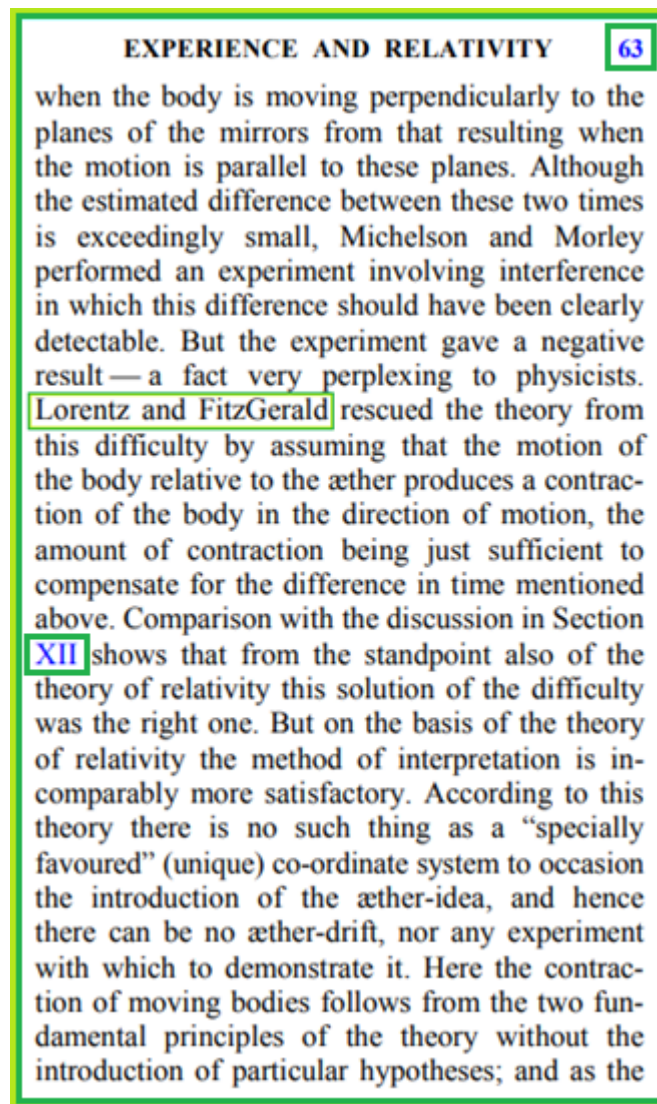

FitzGerald connection to Einstein

The paragraph displayed above is from page 63 of Einstein's Special and General Theory of Relativity. Notice the XII (could the XII in the paragraph above represents the murder of a president with two bullets, the X meaning the elimination and the II meaning with two bullets?) It is my understanding the reason John Fitzgerald Kennedy was assassinated was due to his relatives role in the theory of relativity that helped Einstein and his men becomes successful. FitzGerald was also successful but as you can see his relative was murdered.

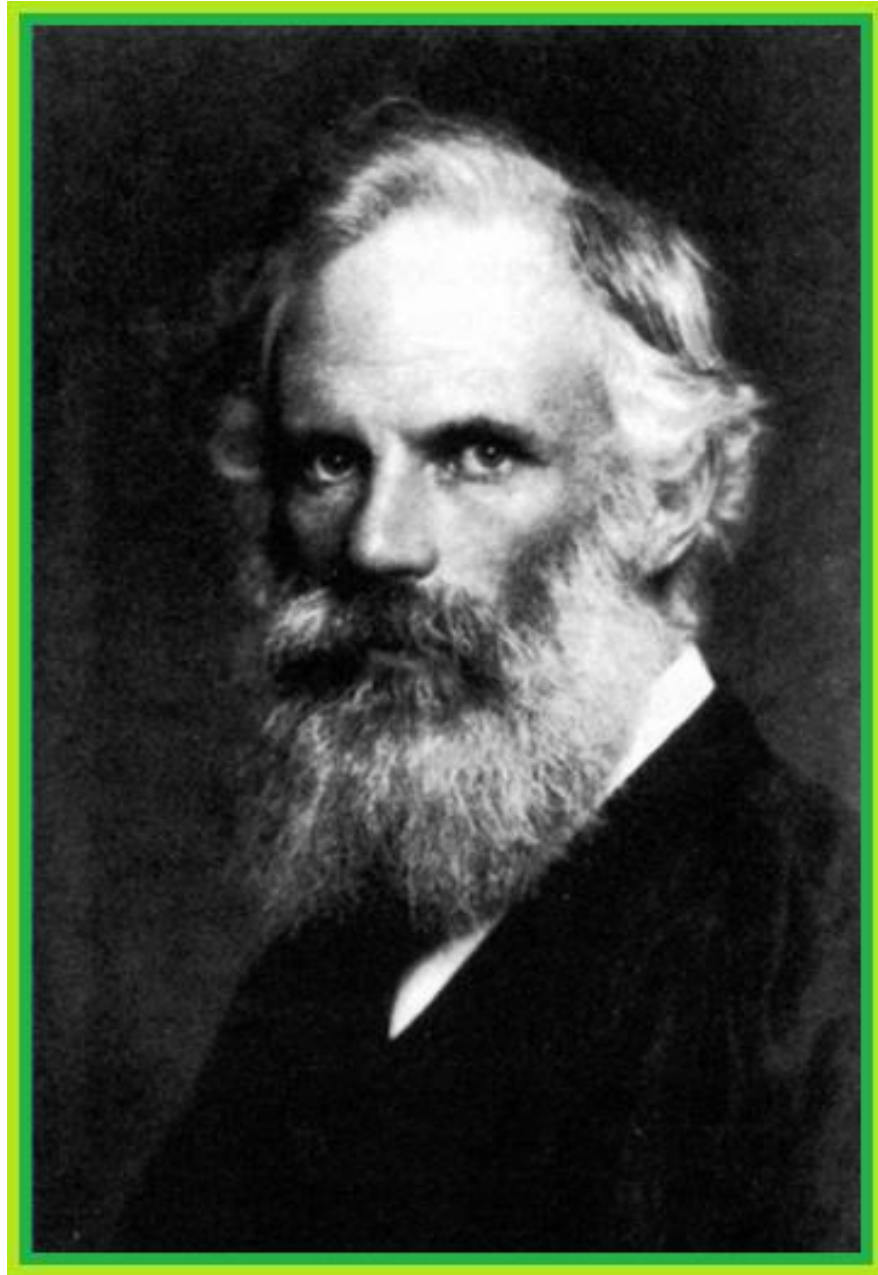

George FitzGerald

$$\sqrt{1 - v^2/c^2}$$

Lorentz-FitzGerald Contraction

Observe as the equation above is the reason why John FitzGerald Kennedy was assassinated. It wasn't a Mafia relation. It was a science relation. The image displayed below connects another scientific mind to The John Fitzgerald Kennedy Assassination. George FitzGerald and Heinrich Hertz were leading figures whom revised, extended, clarified and confirmed mathematical theories. This assassination is without a doubt a scientific feud between scientist.



Hertz

The billboard that is displayed in this picture was placed during the time of the assassination, above the assassination that took place on the 22nd of November, 1963. Heinrich was born on the 22nd of February, 1857. The unit of Frequency, Cycle per second was named after Heinrich Hertz proved the existence of electromagnetic waves. The unit was named after his honor. I have confirmed this billboard being in its position two days after the assassination. The billboard was located at 411 Elm St, Dallas, TX 75202. 12:30 p.m. was the time the assassination took place. Is it not astonishing the ■ [Color](#) of the billboard is ■ [Red 1.1](#) and ■ [Yellow 1.2](#). ■ [Red 1.1](#) and ■ [Yellow 1.2](#) was a ■ [Color](#) scheme used in the Twin Towers. I discuss the significance of ■ [Red 1.1](#) and ■ [Yellow 1.2](#) later in the section. Heinrich Hertz's name was placed in this location not because the assassination "Hurt" as the Central Intelligence Agency thought at the time, but indeed was actually a name of a man of science. The Central Intelligence Agency in 1963 were not as intelligent as we may have thought, or they would have linked science to this murder instead of mafia. The reason they linked mafia to this murder was due to what was transpiring in the nation at the time. The Central Intelligence Agency have been trained only to think about surviving, hence why science was never a lead in the murder of John Fitzgerald Kennedy. Heinrich Hertz was displayed above at this location, George FitzGerald's blood was murdered at this location, and Albert Einstein's $E=MC^2$ laid out the street. I have identified three science names in this murder. Hertz, FitzGerald and Einstein, could this be the reason why three shots were fired when the assassination took place. Three shots were shot during the assassination. Those three shots could represent Hertz (Bullet 1), FitzGerald (Bullet 2) and Einstein (Bullet 3). These three names: Hertz, FitzGerald and Einstein are linked to this assassination in one way or another which leads me to believe that the assassination was a direct link to a scientific discussion that the world has never heard of.



Heinrich Hertz

This image above is of Heinrich Rudolf Hertz, a German Physicist. A science mind that is connected to the assassination. It seems as if Women and Men are placed in power through their relatives breakthroughs in science. For example a man named Michael Moore has power. His realtive Gordon Moore created Moore's Law. Moore's Law is why Michael Moore is in power. Michael Moore is discussed later in Dimension Fusion. It isn't about power and how much noise you can make, it is about your intelligence and how quiet you can be. Contraction is defined as the process of becoming smaller. During birth a women goes through Uterine Contraction. Uterine Contraction is defined as Tightening of uterine muscle fibers that occurs briefly and intermittently throughout pregnancy and more regularly and forcefully during active labor. This Lorentz-FitzGerald Contraction could be the discussion of the assassination of John Fitzgerald Kennedy seeing that this theorem was created before the birth of John Kennedy. We physicist have a secret way of communication. We communicate with equations. Only the elite can communicate in this fashion. Physics is common sense, the real genius are the equations. Each equation that we as a whole have been given to study in the past are plans that must and has remain hidden. Genius. Ask yourself, where and when will you need to use the equation $E=MC^2$ in your lifetime? I answered this question myself and I have come to the conclusion that I will

never in my lifetime ever need that sort of equation to solve a problem in life. The genius is to persuade a masses with an equation, all the while the equation is just another piece to a global plan for domination. Each equation that gets released, the bigger the script of the plan for global domination becomes. It is a code that gets released every 100 years. This means in 1,000 years a sentence will be created by each equation that was released each century. If $E=MC^2$ was the first equation to be released (Which it wasn't) in 1920, 2020 would be the next scientific breakthrough. Little does the world know there is a force that has remained hidden. Suppose $E=MC^2$ is the first word in the sentence, it was released in 1920. The next word to the 10 word sentence will be in 2020. It is 2019 and I have recognized the special communication between the elite that has been controlling your future. I am 1 year shy of 2020. In 1,000 years, a sentence with 10 words will be released. Ulitmatley leading to another phase. Each phase comes with progressive state of communication. My equation below is the checkmate to the elite's communication. This communication is encoded in my DNA.

$$\sqrt[w]{1,000}$$

One Zero Zero Zero

My equation above reads as follows: Wilson (W) checks ($\sqrt{\quad}$) One Thousand Years (1,000). There is a group in this world that listens and waits for an equation to famously appear. The birth of a famous equation is an indication of a Super Genius that corresponds to the plan. The Super Genius that births an equation is without a doubt related to the master manipulators of the past. The Super Genius is without a doubt in complete control of world domination without knowing. What happens when the Super Genuis identifies his control for world domination. World Domination is inevitable. The World is either going to be dominated by Good or by Evil. I am choosing to dominate over Evil with Good. I have full advantage for I have identified my role in World Domination. I have chosen the side of Good. What would you choose if you were in my position. I was in a position where I was creating without knowing, the creation landed in both Evil and Good. I am fully aware of World Domination, and I have chosen the Good side. The master manipulators in the past have created a genus so to speak that requires intelligence, intelliect, and a calculative mind. This group in the past of master manipulators have ran ancestrys and have noted down each genius and each bloodline that has mastered a unique technique. The question I am asking myself right now on November 13th, 2019 is "Am I being noted down in the data books as a Super Genius myself for my revelation of the secret code that I have labeled as One Zero Zero Zero?" My techniques isolate myself and my genus in a new category. W. I, Wilson Alzir Martinez have indentified my control for world domination. I believe I am the first of my kind. In fact I am the first hueman who has indentified my control for world domination. I have at times a totalitarian mind set, therefore I can think like the enemy and halt their plans. I am informing those who choose to tune into my literature. Theoretical physicist are unknowingly creating their own enslavement. Equations these Theoretical physicist have been creating have been setting themselves up for failure. They do not know how letters and numbers work in our reality therefore creating plans for an unseen force. They do not know the mechanics of the alphabet and numbers. Each letter of the alphabet means something entirely different from what these Theoretical physisct claim them to be. The Alphabet isn't something that someone made up, it is a science itself. One must learn how the mechanics work before they begin to use them. For example: I know how a pencil works for I know its mechanics. I know that lead from the ground is placed inbetween wood. Therefore leaving me to use a pencil for I know its proper mechanic. Theoretical physisct are misuing what is invented. X means to

eliminate. X is created by the Greater Than symbol > and the Less Than symbol <. When placed together >< they form an X. It is no longer a debate whether if one is Greater or Less. Now suppose X is used in an equation that pushes science into a new height. Next to the X in the equation is AE. Below is a visual.

$X - \text{Æ}$

Eliminate Albert Einstein

Lets say X is used as a Constant. It is a scientific breakthrough. Æ is for Atomic Energy. Now if X means to Eliminate and Æ is for Atomic Energy, then matters step into confusion when placed in the midst of a genius who knows what X means. X means to eliminate. Now lets say Æ in reality stands for Albert Einstein. The equation above that pushed science to new level remains at rest while the genius knows that X means to Eliminate which places Æ Albert Einstein up for elimination. This means Æ Albert Einstein will be eliminated no questions asked for it is written in equation form. The science community rest while the equation brought an agenda that presents action. The mechanics of letters from the alphabet mean something completely different. It is indeed a code. Back to the Pencil, I know how the Pencil works because I know where the lead comes from and how it creates. I myself can find a piece of lead from the ground and begin using the lead. It is a matter of how these mechanics were created and what these mechanics are used for. One must be very careful, the creator such as Æ Albert Einstein has put himself in a position where he himself must be eliminated just as I have displayed. I am a Theoretical physicist therefore leaving me to use X and Æ in a proper format that writes down Æ Albert Einstein's elimination, for I know X means to eliminate and how X became to be. With proper knowledge and proper care I can create layouts in an orderly fashion without distractions. Mankind is creating their destruction. I on the otherhand am the only person who knows the proper use of the most powerful technique that has ever been created. The more sophisticated an equation, the more confusion it leads towards. In the long run they will be noted down as puppets for they never identified their role in life.

$X - S.H.$

Eliminate Stephen Hawking

I have identified my role and Stephen Hawkings role in life. Stephen Hawkings role in life was to join the cyber universe. Hence why he was fused with technology. Isn't it strange that Stephen Hawkings initials spell Sh. Sh is what you say when you want someone to be quiet. He was immobilized where he couldn't even speak. It seems as if names themselves that children are given at birth are coded messages from the future that correspond to the Hueman. No really, why does Stephen Hawking's initials spell out Sh when in reality that was his fate. He died a quiet man and didn't speak a word since he caught his disease. He must have been doing something wrong. The reality is every academic mind gets loaded with so much information that in the end they feel the need to choose one path. They forget the simple phrases such as Sh when one wants the other to hush (quiet). Stephen Hawking was given Amyotrophic Lateral Sclerosis also known as ALS. It completely immobilized him from speaking and walking. Completely paralyzing him. In reality, his parents named him with the initials that spell out Sh. This is an aggressive vocal gesture one gives. Apparently he wasn't right for the science community and was hushed with a disease. I am the 1% that knows why Stephen Hawking was placed in that wheel chair. I

am reminding the EBE of what names mean. I am setting up my enemies once again. Just like I did 1,000 years ago. The reason why I say to eliminate those two is because their bio-electrical energy was transferred into cyberspace. There is another world beyond ours, it is called The Matrix.

EBE

Extra Biological Entity

Here is another example of literary mechanics. The name EBE has two E's and one B. B is the second letter of the alphabet. Notice there are two E's. It seems as if the B (2) indicates how many E's there will be in this name. EBE is the correct term for "Aliens" they are not Extra-Terrestrial for they are from this planet. Extra-Terrestrial places them in a category of a segregated nature. It is literature mechanics that creates the foundation of everything as a whole. Once literature mechanics is mastered than the creator can begin to create what they please. I am creating the correction of equations with Dimension Fusion, leaving me ahead of everyone in the sciences. Since I am the first to identify my superiors for what they are I am considered all powerful. I am informing my colleague whom I have yet to meet. John Fitzgerald Kennedy was murdered in Dealey Plaza. DP. Dr.Pepper has 23 flavors. W is the 23rd letter of the alphabet. I think there are 26 Gods in total. Each God is represented by a letter of the alphabet. I am W. I am 23. There are also 23 Chromosomes in Huemans. I will discuss 23 Chromosomes in The Super Sapien Hybrid Theorem. Moving forward to the assassination of John Fitzgerald Kennedy and the connection to Albert Einstein.



35th President of The United States

55 years ago an assassination took place in America. The investigation was lead by The Warren Commission; The Warren Commission investigated "The Grassy Knoll" which was a dead end in their investigation. The name Warren is name symbolism for War. As you can see from the name the word war spells the first half of the name Warren. Hence the infamous term "Grass

Roots Dim". I inform the student and reader that there is a woman named Elizabeth Warren who is trying to become president for 2020. The Image above is from Google Images. The Image above is of The 35th President of The United States of America. John Fitzgerald 5Kennedy. He was assassinated on November 22nd 1963 in Dallas, Texas. The Assassination Location was and still is till this day located on an equation based street. The Equation based street reads out as Energy = Mass x Velocity x Velocity $E=MC^2$. The Figure on the next page displays the layout of the equation based Street. $E = MC^2$ is present. These illiterate men of The Secret Masonic Order cannot spell therefore they take the first letter of words so they can identify their secret communication. These "Equations" in the past were nothing more than illiterate men making things up for the masses, while they knew exactly what the letters in the equations meant. The masses were fooled while The Secret Masonic Order communicated. It is my understanding the reason JFK was murdered at $E=MC^2$ was to display dominance over George FitzGerald.

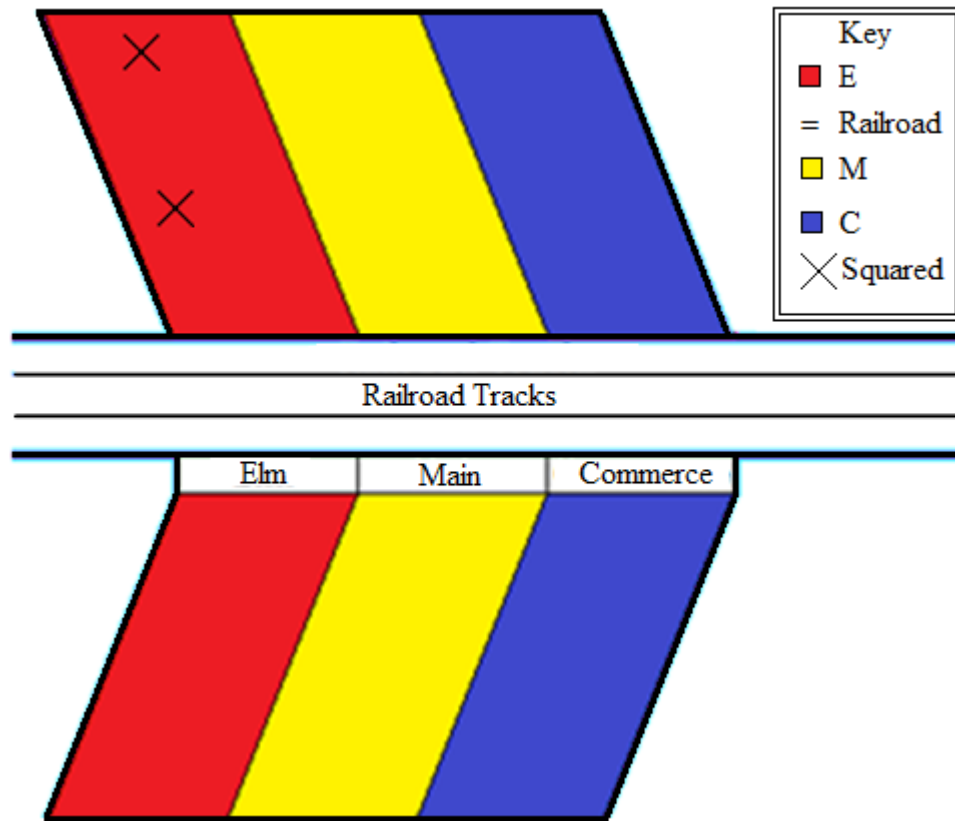

The Secret Masonic Order's Location

The Assassination Location above is a location presented by The Secret Masonic Order. I observed the layout and discovered the location, the location spells out Einstein's $E = MC^2$. Elms St. is the E in $E = MC^2$, The Railroad Tracks above the streets represent the Equal Sign ($=$), Main St is M in $E = MC^2$ and Commerce represents C in $E = MC^2$. The two bullets (X) that struck the president represent the ² in $E = MC^2$. A Bolt Action Rifle is what the assassin used. The rifle name is of Nazi origin. The President was assassinated at precisely 12:30 P.M. The information above was from my own observations, I wasn't given this information. Below I present the conspirator whom conspired against John Fitzgerald Kennedy, The 35th President of The United States. In the Preface I display my own figure of the location of where the assassination took place. The Assassination Location I call it is laid out in secret symbolism by The Secret Masonic

Order. The Secret Masonic Order places the American people in schools and keeps them submissive so that symbolism rules. A person who is highly educated doesn't pay any attention to pictures; they are more focused on the caption above the picture. The Secret Masonic Order was founded on secrecy and symbolism. I am the first person in the world to discover the conspirators of John Fitzgerald Kennedy. I discovered who the conspirators were on January 22nd, 2019 when I left a CPS hearing in Dallas, Tx. I was pissed because they tried to legally kidnap my daughter through CPS. Alexyz Alzir Martinez. My youngest of the three. The government tried to take my daughter away from me so I decided to destroy their rule. True Story. 36th President of The United States of America Lyndon B. Johnson is displayed below. (In reality, I shouldn't care about this man John Kennedy. White folks invaded my ancestors land. No wonder a president was killed in cold blood. But since I discovered who murdered the man I figure it is the right thing to do. This is my ancestors land you people are in.)



36th President of The United States

The photograph that is displayed in the previous page is the 36th President of The United States. The photograph is not an original but is from Google Images. Lyndon B. Johnson, the 36th president of The United States of America snapped a photo while dressing as a woman. It is no surprise that Lyndon B. Johnson signed The Civil Rights Act in 1964 as soon as he became president. This photo can be seen in the Sixth Floor Museum in my hometown Dallas, Tx. The image of The 36th President of The United States that is displayed below is an original. The Location of the image is displayed at the same location where the 35th President of The United States John Fitzgerald Kennedy was assassinated. The image is displayed and is filled with symbolism. Symbolism is equivalent to communication. Symbolism that The Secret Masonic Order uses is indeed the most primitive form of communication. Below is the photograph that relates to John Fitzgerald Kennedy and the conspirator. This image presents a strategy of posing as the opposite sex in an operation. This strategy is used till this very day by the Central Intelligence Agency. The 35th President of The United States posed in the strategic form that is cross dressing.



Grass Roots Dim

The photo above was taken by me, Wilson Alzir Martinez on January 22nd 2019 at 1:00 P.M. I walked into the Sixth Floor Museum which is located at 411 Elm St, Dallas, TX 75202 and snapped this photo of the Vice President Lyndon B. Johnson. The Vice President is dressed as a woman and is holding a sign that reads "JFK Glad to see you Grass Roots Dim". Notice the height of the "woman" holding "Grass Roots Dim". Lyndon B. Johnson is 6 feet 4 inches tall. This woman is the same height. Next to Lyndon B. Johnson stands a woman holding an umbrella which appears to resemble the sniper rifle used in the assassinations. The photo is an

original taken by me, Wilson Alzir Martinez. The Vice President is foreshadowing The Grassy Knoll Investigation committed by The Warren Commission. (Note Elizabeth Warren is trying to become president.) The words “Grass Roots Dim” represents the trail that The Grassy Knoll investigation was heading towards. The information in the Preface about John Fitzgerald Kennedy and the assassination location was discovered after I discovered who conspired against John Fitzgerald Kennedy. The word Knoll is pronounced as Null. The definition of Null reads out as “having no legal or binding force; invalid”. These Masonic men, and the women who follow the lead of these Masonic men have laid out a plan where cross dressing is the biggest form of secrecy and a means of escape. If a crime is committed by a Man, the officers are going to be after a Man. This tactic of cross-dressing helps the Woman escape for she committed the crime posing as a Man. Spray tans are also a danger. It changes the perception of the person’s skin tone. If I commit a crime as a brown individual the police department will be searching for a brown individual. I am Hispanic and have a light complexion. The spray tan will create the appearance of my skin being brown. Transsexuals and Homosexuality has been crumbling the nation with tactics created by the C.I.A.



The Zapruder Film

The image above is from Google Images. The Zapruder Film is symbolized in the photograph I took when I made my way to Dealey Plaza. This man who filmed the assassination Abraham Zapruder was a conspirator for he filmed the assassination which became famous. Notice the word Zap in Zapruder. Zap means to destroy or obliterate. This means that the man Abraham Zapruder was a conspirator. The A in Abraham represents the mechanic of 1; 1 means victory Z is a mechanic used by the Nazi. Z is for Nazi. The Masonic Secret Order uses symbolism. Symbolism is the most primitive form of communication. These Masonic Men have low IQ’s and are illiterate therefore they turn to symbols. The image on the next page displays The Secret Masonic Order of the world’s finest symbolism. The man holding the camera symbolizes The Zapruder Film. The Fence that stands in front of the man holding the camera is the Fence that the assassin was placed behind at the time of the shooting. The lone gunman is standing behind the man with the camera. The photo symbolizes a man shooting. Hence why the man in the trench coat is placed directly behind the camera man. The image is displayed as if the man in the trench coat is pointing a gun at the person who took the photo. These men who were all conspirators of the assassination of John Fitzgerald Kennedy are placed in perfect position to send a message to whoever spoke against what this image signifies.



The Shooter behind Zapruder

This photograph was also taken by me, Wilson Alzir Martinez at the Sixth Floor Museum. I took this photograph on January 22nd, 2019. The original photograph I call “The Shooter Behind Zapruder” displays the Shooter who shot John Fitzgerald Kennedy. The photograph above represents the Sniper Rifle, The Zapruder Film and the lone gunmen. The woman in the picture on the top left holding an umbrella that resembles a Sniper Rifle represents the Sniper Rifle that was used to assassinate John Fitzgerald Kennedy, The 35th President of The United States John Fitzgerald Kennedy. The Camera that the man is holding represents the Zapruder Film. On the top right behind the Camera man who may also have been the shooter stands a man wearing a trench coat and hat, the Shooter who assassinated John Fitzgerald Kennedy. The Photograph is of another photograph. This Gigantic Photograph is in the entrance of the Sixth Floor Museum located at 411 Elm St, Dallas, TX 75202. No money is needed to see this photograph. This Section of Dimension Fusion places the danger of Homosexuality and Transsexuals. It is beyond diseases. For diseases are curable. Secrecy and Conspiracy is not. I believe I am the first to discover who conspired against Kennedy, therefore leaving my word being 100% trustworthy. In my opinion this photograph was rehearsed, there are too many coincidences for example, the woman on the right hand side holding the umbrella. The umbrella she is holding appears to resemble a rifle. The man holding the camera aiming the camera lens at the photographer is another reference to the shooting. It is no coincidence that these people in this photograph happened to display corresponding symbols related to the event.

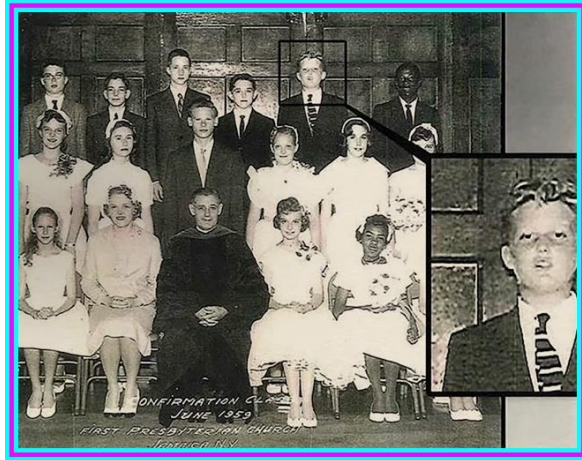

The Confirmation

The image above is from an article named “The God and The Don”. The first time I seen this picture was in Donald Trump’s book “Great Again”. He uploaded the photo on December 11th, 2014 two years before the man was elected posted this picture on Facebook and on Instagram. He called it his Throwback Thursday. How ingenious that he posted the picture on the 11th and Two years before the election. The classic mechanic of II is present. The 11th is II and the Two years. Observe the cross behind this young man in the striped tie. Confirmation Class represents C². The C in Confirmation represents the C in C², and the C in Class represents the 2 in C². The young man in the image above is Donald John Trump in his Confirmation Class. The 45th President of The United States. The Secret Masonic Order placed symbolism in this photograph to display their place in politics. This photograph was taken before John Fitzgerald Kennedy was President. Donald John Trump, The 45th President of The United States stands on the last row top right next to the African American child. The African American child represents the 44th President of The United States. Barrack Hussein Obama. (take note of the word Ein in Hussein.) Barrack Hussein Obama is reported in America as an African American. The term African American also bears the mechanic of II. The A in African represents the first bolt of lightning and the A in American represents the second bolt of lightning. This photograph is of Donald John Trump in his “Confirmation Class” in June 1959 at the First Presbyterian Church, Jamaica, Ny. He is the only child that is wearing a tie with stripes. The tie represents the 13 Stripes on the America Flag. The location at this address is located on 89-60 164th St, Jamaica, NY 11432. This photograph is proof that no matter what the ballads read of The American people as a whole, The President of The United States is selected. The selection of The President of The United States is not in our hands, an election is, but the selection of our leader is not. The Secret Masonic Order places symbolism in photographs as a strategy for no legal binding to occur. Symbolism is the most primitive form of communication, if not the first form of communication. Which sums up to legal binding no matter what the situation is. These men who are in The Secret Masonic Order have been using symbolism for centuries and have ruled with that symbolism. The most popular symbol of death is displayed as a man hanging on a cross. You may have heard of him, his name is Jesus Christ. The Symbol of a crucifix does not display salvation but displays death to whomever crosses their path. The reason Jesus Christ was crucified was because a kiss that Judas gave Jesus. Homosexuality was frowned upon and was considered an abomination. Jesus Christ was in The Secret Masonic Order and when Jesus Christ was “betrayed” by Judas, the secret of the ruling presidency that was Jesus Christ was overthrown because homosexuality was an Order that ruled The Masons of the land at the time. Jesus Christ was to the land of his people as The

President of The United States is to America. Homosexuality has been frowned upon since ancient times. The Secret Masonic Order kept the homosexual preference a secret since Jesus Christ's time. The Secret Masonic Order is equivalent to The Mafia. Secrecy rules in a brotherhood. Only men are allowed in The Secret Masonic Order. The Image below is from Google Images. In modern times, Homosexuality is still frowned upon and The Secret Masonic Order still keeps the old ways of secrecy at bay in their rule. If anyone found out about any politicians being homosexual the politician will end up being killed by The Secret Masonic Order. You cannot be popular in the world without being a homosexual or committing homosexual acts. This is why homosexuality has been a major topic in the world as of 2019. They have even placed a homosexual politician as a 2020 candidate for President of The United States. The more comfortable the people of The United States of America feel about homosexuality, the easier it is for The Secret Order of Masonic Men to move around. Jesus Christ was considered President of his land. He was nothing more than a leader to the people and he was considered holy. (I had no idea that Donald Trump's last name contained Christ. His father's last name was Christ and he added Trump to his name.) The stories about him healing the sick and walking on water and supernatural powers were just an exaggeration. Just like in Greek Mythology the stories of Greek Mythology are highly exaggerated. If the student and reader does not know of Greek Mythology and the exaggeration of the stories the student and reader is more than welcome to do his or her own research. The crucifix is a symbol for death. The symbol is the oldest symbol in The Secret Masonic Order. This is how they began to rule. Is it possible this was the first conspiracy of a leader? Could it be possible that Jesus Christ's apostles conspired against his family and his campaign and gained the thrown in power. Is it possible that he was a puppet by The Secret Order of The Masons? The similarities of an assassination of John Fitzgerald Kennedy is equivalent to Jesus Christ being crucified. How so? Well Jesus was a leader, Kennedy was a leader. Jesus had an administration of 12. Kennedy had an Administration. Jesus was betrayed by his Apostle Judas; Kennedy was betrayed by his Vice President Lyndon B. Johnson. Jesus was hung for the people of the land to see. Kennedy was assassinated for the American people to see. The similarities are present in these two cases. The Secret Masonic Order knew Jesus' sexual preference and with the knowledge of Jesus' Sexual Preference, they strategized the overthrow of his rule. Jesus Christ was nothing more than a leader of a nation. He didn't have magic powers, he didn't heal the sick. Those people who claimed to be sick were actors and acted like they were healed. It was all an act. The World is a stage in their eyes. The Roman Numeral II is placed as a Crucifix with the I crossing the I. The Crucifix has also made its way onto food labels to display the outcome of the consumption of the product for the consumer. † This symbol is called a dagger, in reality it's just a fancy Crucifix. Remember Julius Caesar was stabbed to death by a 23 Dagger. † symbolizes Death. The Crucifix is known to the masses as a positive thing, it is masked as salvation but in reality it represents death.



The Crucifixion of Jesus Christ

The Knights Templar founded in 1119, Jerusalem, Israel was an order from the Catholic Church. C^2 is also present in Catholic Church. The C in Catholic represents the C in C^2 , and The C in Church represents the 2 in C^2 . The order was to send out a group of men and claim the land in their favor. The favor was their choice of religion and their set of rules. The religion was Christianity. The Red Cross displayed on the Knights templar body armor represented the bloodshed from those who opposed the Vatican's order. The image below is from Google Images.



The Knights Templar



These Men from The Order of The Knights Templar would slaughter you and your family if you did not pay allegiance to their rule. If you didn't become submissive to their religion they would slaughter you and your household. Christianity was founded on death. Not salvation. The Vatican of Rome sent out The Knights Templar to place authority and this is how Christianity became popular. They paved the way for Christianity through force. The Pope of The Vatican also ran operations of The Nazi in World War II. The Nazi Salute is actually from Rome. It is called The Roman Salute. Displayed below is a picture of the Pope Pias 11 and The Roman Salute. The Number 11 is a classic mechanic that represents Two Lightning Bolts. The Roman Salute has evolved as a way to greet people. A wave of the hand is an evolved form of The Roman Salute. To get the teachers permission to speak, the student raises his or her hand. It is a Roman Salute. From a Confirmation to be President of The United States to Jesus Christ, The Secret Order of The Masons have been ruling dynasty's in secret.



The Roman Salute



Star Wars Connection

The Story of Star Wars starring Jedi Knights is a plan from The Secret Masonic Order. It is a script for the Future. 3000 years from now Star Wars will be a thing of the past and will not be known by the people that live in the year 5019. Star Wars is the equivalent to The Bible. The real stories and the origins of the stories are kept secret but the exaggerations of the stories are not. Superpowers fascinates the people. It displays godly powers. Displayed above is the evolved state of The Knights Templar. The Knights Templar used a Red Cross as their symbol. Notice the weapon this person is using is a Red Cross. It is from a written script called Star Wars. The Vatican is where The Mafias of The World gain respect from. If you didn't become Submissive to the Bloody Red Cross, Death was brought upon you. The directors of Hollywood are directing the future. All the scriptures of Protagonist and Antagonist battles are derived from William Shakespeare. It is all an act. They script out fictitious scenes and when the world has forgotten these scenes that were displayed in fictitious films they present these acts in the timeline best suitable. As you can see, Light sabers are not in our reality. Therefore this script is locked away and is archived for later. They archive information and present it in the future. Religious Scriptures are equivalent to Hollywood movie scriptures. This was going to be the future of The Secret Masonic Order. My Dimension Fusion completely destroyed their chances at this take. The student and reader must be advised that Dimension Fusion will enhance and change the perception depth of reality. These men have immobilized themselves from mastering my technique that is Crimsonology. Crimsonology will be discussed later in this section. They have created a symbol with all the  Colors and created a blockade for themselves from mastering a language that I have invented. I myself am against homosexuality. I think it's wrong. These men and women created a system where the knowledge of  Colors is forgotten by sexual preference. This tactic that has been crumbling the nation's stance in the world and is backed up by more psychological manipulation, music has been a tool in which they implant homosexual innuendos in which the subconscious mind receives and is acted out. Depending on the intelligence of the man or woman who received the subliminal message. Physiological tactics have been used as well with pheromones placed in colognes that we men and women enjoy instead of the masses on earth subjected to the right scent. We have been subjected to the complete opposite. In reality, the women should have been subjected to Cologne when it was invented. The man should have been subjected to Perfume when it was invented. Why? The pheromones placed in Cologne attracts the male, for the male is attracted to the scent. Hence why the women should have been subjected to Cologne from the start. The man should have been subjected to Perfume for the pheromones attract a women. Why would I wear Cologne when Cologne attracts males. That is the physiological effect on that note and the psychological effect is P is for Pussy and C is for Cock. Notice the P for Perfume and C for Cologne. Psychologically the mind is pulled into confusion for the scent that the man wears Cologne, it starts with a C

which should attract a P. The women also gets pulled into confusion as she wears Perfume, it starts with a P which should attract a C but in reality our animal instincts kick in and we are fooled by these scents and the labels that read the opposite of what we should be attracted to. Here is an example just to paint a picture. I walk into a store and walk by a new Cologne set. I am already attracted to the scent as soon as I walk into the store. Psychologically I have been fooled from the start because I have been told it is the norm to wear Cologne. Question. Why would I purchase a scent that attracted me. In other words, why would I purchase a scent if it attracts a male? The norm should be that I purchase a scent that women are attracted to such as Perfume. Isn't it funny how that the first syllable of Perfume sounds like Purr. Like a cat. In today's world Pussy is defined as a Cat. In laments terms. It is no coincidence that the first syllable of Cologne sounds like Colon. Colon of man. This is how these men in The Secret Masonic Order have fooled the masses. They place the exact opposite. Now, if they are doing this with scents. What could you be doing in this world that is the complete opposite of your goal that you are trying to achieve. If you are a man and wear Cologne I suggest you throw it away. If you wear Perfume and are a women I suggest you throw it away. P attracts C and C attracts P. The fact of the matter is that scientist took the study of pheromones in the animal kingdom and placed them as weapons as genocide. A penis is like a syringe, if the host has HIV or AIDS and the host has intercourse unprotected they infect and the cycle continues. They have been spraying pheromones in the atmosphere that trigger the population physiologically. A flehman response is when a lion or lioness urinates to show ownership of territory. This helps with mating for example. Me being a lion I would ward off other males by peeing on my mate. They use whale urine in Perfumes. Now, if the Flehman response triggers hormones in animals, what do you think a gigantic animal's urine will do on a race when dousing themselves in said Urine/Perfume? Just think about that last sentence for a moment. It is an unseen force that must be stopped. Body washes and Shower Gel's also intensify this affect as we lather the pheromones into our pores. Below is a comparison between Whale and The Super Sapien Hybrid (Human). Think of the mass confusion being placed on Humans in the form of a bottle. They are even misspelling words and placing them on Cologne bottles. Savage is spelled Savage not Sauvage. They use illiterate spelling to dumb down the rich. Only a rich person would waste their time spending money on that product. They target the rich and the rich effect the poor it a cycle that effects the world inevitably. Do you think Cologne has anything to do with Colon Cancer (C²)? The first syllable Col is displayed in both Colon and Cologne. You may be asking how do I know this? A good friend named Charlotte Andrews said "you know what your problem was with Anna (ex-girlfriend), Wilson. You didn't pee on her". Question. Do you think our lawns are being doused with a certain group's urine and feces as fertilizers.? Do you think urine from these groups are doused in the atmosphere to keep us submissive?

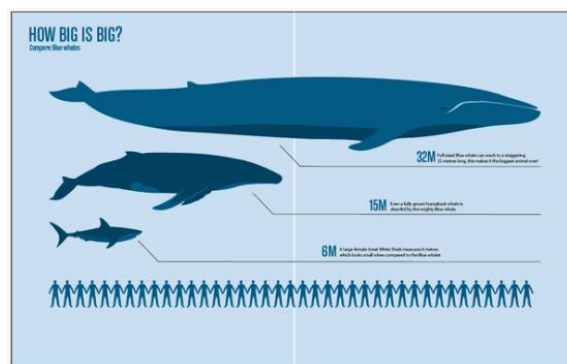

















Urine for a surprise

Opposites Attract

My formula above breaks down the last paragraph that dealt with Perfumes and Colognes. With the knowledge of scents going around in the air as a giant storm of aromas which we do not see, we are under a physiological attack. Add Music to this silent attack and you get the complete confusion and destruction of man-kinds reproduction. Have you not noticed all the homosexual presence in music. The most influential “Rap” music has the most subliminal homosexual messages. If you haven’t noticed, the world around you has been getting more and more feminine. Now don’t get me wrong there is nothing wrong with femininity, but when the mascot for femininity is Boy George (shown below) then I wouldn’t want to follow the crowd that is being led into a downfall. I don’t have anything against homosexuals; I am helping them by informing them that there is a secret agenda of genocide playing out. There are innocent homosexual being prayed on every day and they are extorted and prostituted. These Perfumes and Colognes block pores that release pheromones for reproduction. Perfumes and Colognes don’t attract mates they repel. Leaving you behind in the reproduction line.



Boy George

The image above is a man whom I never followed. Thank god. Not that I have anything against him, I’m not homosexual is all. Moving forward. The homosexual agenda was to breakdown the conscious awareness of the reality that is set forth by nature. By breaking down the conscious awareness of natures  Colors, our minds are molded into something that nature did not intend to mold. Our ancestors fought and stayed alive through the knowledge of  Colors Placing a flag with such an abomination made the masses forget about the knowledge of Colors. This read reprograms the average human in its natural state. The tactic of using the homosexual community was a tactic that has been used since the 70’s. Man knows subconsciously that homosexuality is repulsive and these men and women have been using subliminal messages to break down the mind. The Secret Masonic Order has a way of showing who is Homosexual and lesbian. The man or woman of The Secret Masonic Order dyes their hair. They dye their hair either  Red or Blonde. In the past  Colors have been used in wars.  Colors are what we call Attire in war.  Colors In war have been used throughout centuries, in the early 1800’s, a famous leader named Napoleon Bonaparte presented a Grey hue with his militia. The  Colors that Napoleon Bonaparte presented was called Marengo. The British during the Revolutionary War were called  Red Coats. In the civil war a battle was fought and how the soldier knew who the enemy was; was by their “ Colors”. The union wore  Grey 4.8 and  Blue 1.3. The Confederates wore  Red 1.1 and  Grey 4.8. The police that hold power and stand proudly behind their badges also use the  Colors  Red 1.1 and  Blue 1.3 to present danger. It is with these two  Colors that alert the neighborhood of what is transpiring in the area. Police men and women who are corrupt implant hatred to children when they use brutal force against their

parents. The hatred of these men and women in law enforcement are created by the corrupt. This ignites hatred and forms gangs in neighborhoods whom the innocent men and women of law enforcement patrol. In order to survive in neighborhoods like the “Ghettos” in America one needs to be representing the right colors. If [Blue 1.3](#) Graffiti is written all over the walls then [Blue 1.3](#) attire is to be presented in said neighborhood, if [Red 1.1](#) is presented in said neighborhood then death is the outcome. If [Red 1.1](#) Graffiti is written all over the walls then [Red 1.1](#) attire is to be presented in said neighborhood, failure to do so will ensure death, for these men and women of Ghettos have grown up to stand boldly and proudly to their [Colors](#). The knowledge of [Colors](#) has been keeping us out of harm’s way. Gangs such as the [Bloods 1.1](#) and [Crips 1.3](#) who the people look down upon reflect back towards politics. With a nation ruled by Democracy whose sides are represented by [Red 1.1](#) and [Blue 1.3](#). Subconsciously the Republicans are considered [Red 1.1](#) and the Democrats are considered [Blue 1.3](#) reflect back towards the Gangs in the streets where the [Bloods 1.1](#) are considered [Red 1.1](#) and where the [Crips 1.3](#) are considered [Blue 1.3](#). Unaware these men have gained power through politicians in office and the gangs of the streets. These men and women who hide like rats have had control of both sides of the spectrum. Politics reflects backs towards the street code and vice versa. Just like the Civil War they have created a modern Civil War with [Colors](#). They used the knowledge they created with [Red 1.1](#) and [Blue 1.3](#) from the Civil War and implanted these colors to politics and gangs. As children we are taught the [Colors](#), and then after [Colors](#) of history are taught to us as we advance, eventually coming to a halt with the [Colors](#) of our nation. A nation who fought against each other and befriended those who presented the [Colors](#) they were fighting for, as you can see the pattern is present. The civil war presented [Blue 1.3](#) and [Red 1.1](#). This is a psychological tactic. It implants the hatred for [Colors](#). How? Well, as a child, one would most definitely frown upon slavery. The Confederates are labeled as [Red 1.1](#). Creating animosity in our world. The “Heroes” were against slavery and were represented by [Blue 1.3](#) these men that wore [Blue 1.3](#) were the Union. Psychologically we are placed in a battle as children. Which binds our heads into a mass manipulative tactic. Children of ghettos such as Watts in California are psychologically controlled by [Colors](#). (Watt is an electric measurement which doesn’t surprise me on what transpired in Watts) Where they lose their lives later due to the setting their in. Bloods and Crips rule the streets in Ghettos and those reflect back towards Politics. Democracy is what Gangs whos rule are [Colors](#) reflect back towards. As children we are placed in a setting where subconsciously we have to decide which side is better for the nation [Red 1.1](#) or [Blue 1.3](#). This is why Democracy is labeled between two [Colors](#). As children we do not pay much attention to the faces but our minds set focus on the [Colors](#) and the names of the faces as the names will sure enough pop up again once we are older. As a child I didn’t know who George Bush Sr. was but his name was brought up once again in politics by his son George Bush Jr. The name is then brokendown in my head and the [Color](#) is ignited in my mind where it remembers and triggers a thought. It is a psychological tactic that has been used for centuries. These men and women had gained control of [Colors](#) where the past was forgotten. How was it forgotten? They used the homosexual community and a Flag. The flag consist of all [Colors](#). [Red 1.1](#), [Orange 2.1](#), [Yellow 1.2](#), [Green 2.2](#), [Blue 1.3](#) and [Purple 2.3](#) Causing mass confusion. They even placed homosexuals in the Army. Making their Flag “The Rainbow” infiltrate the world’s powers. Causing a state of confusion subliminally. Our ancestors used colors to stay alive; they broke down [Colors](#) and passed down the knowledge of [Colors](#) to us. These so called “Genius” men and women have stolen our [Colors](#) just like how in a militant setting would steal from an army base [Colors](#) to show dominance. [Colors](#) present ancient knowledge from our ancestors. These illiterate men rely on [Colors](#). This is the main

reason why they control **Colors**. They cannot spell or read. These Masonic men and women (because they like to dress like woman; the Masonic men.) relied on Symbols and **Colors** to advance in life. Let the reprogramming of **Colors** commence for the student and reader. **Black 4.9** and **Yellow 1.2** meaning caution as the choice of **Colors** on a wet floor sign, when a murder has taken place and the detectives have wrapped **Black 4.9** and **Yellow 1.2** tape with the words spelling out caution, a construction site with **Yellow 1.2** and **Black 4.9** signaling the dangers of one that isn't aware that there is construction on the premises; For Radiation use **Yellow 1.2** and **Black 4.9** are present in the area. It is used around the world in many forms. Around construction sites, work areas in the streets, food packages and restaurants. Unfortunately school buses are labeled as **Yellow 1.2** and **Black 4.9** for there are many dangers in schools such as drugs and school shooters







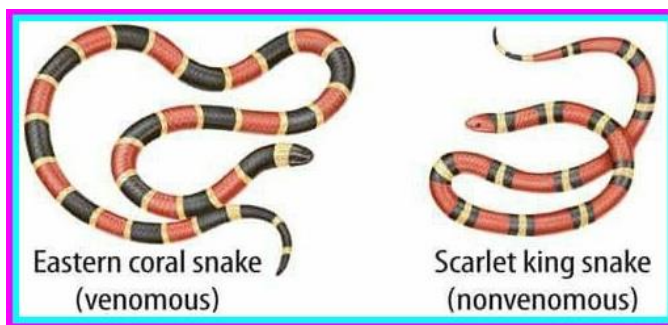



































Printer Color Blocks

Notice that on every package of food there is a **Color Code (C²)**. Take a close look and you will begin to realize that the Coral Snake that is **Color Coded (C²)** in **Red 1.1** and **Yellow 1.2** has evolved into an edible item. A quick question: what is safe to consume, a package that reads **Yellow 1.2** with a Nutrition Fact Label reading Healthy or a package that reads **Red 1.1** that the Nutrition Facts Label reads unhealthy? My ancestor's memory cells kick in when it comes to this decision and I without a doubt choose **Red 1.1** because the **Color** scheme that I chose is not venomous if it were a snake. If **Red 1.1** and **Yellow 1.2** touch that means it's venomous. If **Red 1.1** and **Black 4.9** touch it is non-venomous. Take notice of the image below. Notice our ancestors identified these **Colors**.



Serpentes

Yellow 1.2 This **Color** scheme is highly venomous therefore I do not decide on consuming this item. With so many distractions and unnecessary technology we humans have forgotten what has kept us alive in ancient times. Making it an easy Genocide for those who conquered the Ancients

and used the Ancient's  Colors against humanity. Could you imagine reading a scripture that was created by a conquistador stating and I quote "We will  Color process their favorite dishes in packages in  Color Codes (C²) that only their ancestors knew about, leaving them defenseless for an eternity. These  Color Codes (C²) will be our identification for we have successfully diminished the Ancient knowledge passed down to generations that ensured their safety when it came to these animals that were coded in  Color." The Secret Masonic Order who has been in control of these  Color Codes (C²) have created an illusion where  Colors meant a group of people. With the world disgusted by Homosexuality that The Secret Masonic Order has labeled with the Rainbow, the world has slowly forgotten about  Color Codes (C²). This is probably why they have idolized  Colors. Correct me if I'm wrong but this is indeed the power that these men have had.  Colors.  Colors has been without a doubt a powerful tactic against humanity and presents strength. Here is a strategy to take down high ranking member in a branch. Find out what his or her favorite  Colors are and his or her favorite dish and place those deadly toxins in their favorite dishes and package them in their favorite  Colors. By now the world has forgotten about  Colors for they have been representing a homosexual community in which the world frowns upon. Let's face it, Homosexuality is indeed wrong. Now that I have stripped the  Colors from these The Secret Masonic Order let's talk about these  Colors you see on packages. The  Colors that are on packages are called "Printer's  Colors Blocks" or "Process Control Patches", this grid of  Color swatches indicates which hues of ink were used to produce the design on the package. The printer checks these  Colored circles or squares to determine where a package conforms to the necessary  Colors scheme for the product. Take a look at a package of unhealthy potato chips. Notice the  Color Codes (C²). It's a code for "Member's only". Meaning 1% of the world knows about this secret. You'll notice that even the "process  Color patches" do not correspond to the package. Through my own observations, I have come to the conclusion that certain  Colors on packages are warnings for consumption. As time went by it seems that the Dimension of  Color has only been used as a means to manipulate and fight against humanity in a militant operation. Take a look around and you'll notice what has been passed down since ancient times to us since we were children and when our parents were children and when our grandparents were children. As time progressed on we became intertwined in a bubble of "Safety". We forgot what the first basics of survival our ancestors discovered before the fire which was  Colors. Without the knowledge of  Colors, what hope does humanity have in becoming how it once started? Without war and without destruction. Being in a safe environment doesn't necessarily create a safe way of living. It turns out that the safer an environment in 2019 the more you have to worry about the consumption of ordinary foods. They have basically evolved the common coral snake and dart frogs and turned them into edible items. How? The bright  Colors on Packages are an evolved state of warfare that these men and women produced. Meaning the more you ingest the items that are quite venomous, the toxins in the body will accumulate and will eventually take on things other than the nervous system. The venom in these abiotic items that is stored safely on shelves are packed with highly venomous ingredients and the venom will accumulate and will go straight for major organs. The  Color Grease is  Yellow 1.2; our blood in our bodies is the  Color  Red 1.1. The Colors  Red 1.1 and  Yellow 1.2 symbolize Death. The Consumption of Greasy foods will eventually kill the Consumer. Notice that Eggs are  Yellow 1.2 which indicates to the consumer they must not consume so much. Butter is also  Yellow 1.2 also warning the consumer not to consume so much. Bananas are  Yellow 1.2, Bananas contain Potassium. Too much Potassium can turn deadly.  Yellow 1.2.  Yellow 1.2 lines on the road leaves a subliminal to the driver on the road to slow down. When driving a car when the traffic light turns  Yellow 1.2 it is imperative for the driver to slow down. Anything  Yellow 1.2

that is edible must be rationed, too much will eventually kill the consumer. The Oil used in Fryers is ■ Yellow 1.2, ■ Red 1.1 and ■ Yellow 1.2 for example is the ■ Color scheme for McDonalds. The significance of the ■ Colors, ■ Red 1.1 and ■ Yellow 1.2 are displayed as the scheme for fast food restaurants and items that are not edible. ■ Red 1.1 and ■ Yellow 1.2 is how you figure out if it is indeed a Coral Snake. Coral Snakes are highly venomous. Their ■ Color scheme is ■ Red 1.1 and ■ Yellow 1.2. ■ Colors have been used since ancient times such as the Indian discovering the dangers of the ■ Black 4.9 and ■ Yellow 1.2 poison dart frog and its uses to win battles and poisoning their enemies. These men use these tactics in order to keep the masses in a sick state, by labeling these packages with these ■ Colors they know what to consume and what not to consume. Let's dive right into the past and create a massive ripple in the mind for "Future" reference now. Think of yourself as a native Indian. You and your father have left the tribe to go gather fruits for the rest of the tribe. Before you and your father have left to gather fruit you take notice that another tribe member has struck ■ Gold 3.1 with a massive amount of frogs. ■ Yellow 1.2 and ■ Black 4.9 Frogs.



Poison Dart Frog

You and your father don't make it in time to begin the feast with the rest of the tribe, for you and your father suddenly encountered a wild boar and began to hunt it down. Arriving at the village you take notice that a basket is on the ground and so are the tribe members. You take notice that there are ■ Yellow 1.2 and ■ Black 4.9 frogs leaping over tribe members. ■ Yellow 1.2 and ■ Black 4.9 frogs in the mouths of the tribe members who have perished due to toxins in the frogs. The word is spread throughout the land after you and your father are the only survivors and you end up teaching the ways of ■ Colors. Later you take notice that a simple rub of your darts that you catch prey with is x10 more effective when the ■ Yellow 1.2 and ■ Black 4.9 frog are rubbed against the darts. Many battles are won. Through this mechanic. Just with the simple knowledge of ■ Colors, ■ Yellow 1.2 and ■ Black 4.9 means Caution. ■ Red 1.1 and ■ Yellow 1.2 means death. Come across a ■ Red 1.1 and ■ Yellow 1.2 snake such as the coral snake and you're a dead fellow. An ambulance in the street blaring its sirens and honking their horns bare the colors scheme which signifies death and these ■ Colors are none other than the ■ Colors, ■ Red 1.1 and ■ Yellow 1.2. If the student and reader has paid attention and is not a complete moron then they themselves have noticed the ■ Colors, ■ Red 1.1 and ■ Yellow 1.2 on fast food restaurants logos such as McDonald's, In and out burger or Carl's Jr, etc. looking from a captain's' point of view the use of ■ Colors and the knowledge of ■ Colors will help my team be victorious in the long run. Consuming ■ Orange 2.1 spells death as well. ■ Red 1.1 plus ■ Yellow 1.2 equal ■ Orange 2.1 simple logic explains the outcome of ■ Orange 2.1. Do not consume any products that contain the Color ■ Orange 2.1. This goes beyond reading the Nutrition Facts Label.

Nutrition Facts	
Serving Size 1 Tbsp (21g)	
Serving Per Container 11	
Amount Per Serving	
Calories 60	
% Daily Value*	
Total Fat 0g	0%
Sodium 0mg	0%
Total Carb. 17g	6%
Sugars 16g	
Protein 0g	0%
*Percent Daily Values are based on a 2,000 calorie diet.	
8 oz. (226g) Honey	

WARNING: Do not feed honey to infants under one year.

Redundancy

If you failed Einstein's $E=MC^2$ then for sure you will fail Edibles, for you perceive things with an academic mind instead of an abstract mind. It is somewhat like cheating. You don't know how the mechanic was created so you are automatically cheating by reading the answers to a mechanic that you didn't create. This system is built on the word cheat. **Colors** are as easy as 1 2 3. It is funny how one could easily forget what kept their ancestors alive when there are so many redundant words to read. Redundant is defined as not or no longer needed or useful; superfluous. Why would one read so many redundant words when all they have to do is learn the mechanics. Here is a perfect example. If there is no Nutrition Facts Label on processed meat or vegetables the scholar pays no mind and moves forward. Me as a person who discovered these mechanics can answer the question quickly. Meat is the color **Red 1.1** and Vegetables is the **Color Green 2.2**. **Red 1.1** means to stop and **Green 2.2** means to go. Notice that the definitions are also inverted, for the opposite of Go is Stop. I will discuss The Inversion of **Colors** later in the read. The scholar knows nothing about this. For he spent his whole life learning and reading so many redundant words that the basic red means stop and green means go is forgotten. So, when you walk into a store and skim the aisles and you are looking for a meal to cook. Don't go with the meat, for it is **Red 1.1**. Go **Green 2.2**. I was looking for something to eat in the fridge and I couldn't help but to notice what my mom had purchased to eat. She bought to different kinds of meats. One of these meats had a **Red 1.1** and **Yellow 1.2** (**Red 1.1** and **Yellow 1.2** means death.) label. The other was in a **Black 4.9** package. **Red 1.1** and **Black 4.9** means your okay jack (**Red 1.1** being the meat and **Black 4.9** being the package.), but I couldn't help think that if Meat is red and red means to stop then surely even the **Black 4.9** package doesn't mean it is safe. My discovery of this subject is new and I am identifying beyond the Nutrition Facts Label that these fools have given us. I went with **Green 2.2** after I remembered my literature that is Dimension Fusion. If I were to tell my mother this she would think I was nuts. Why? Because adults don't listen to the youth. They believe they are more intelligent because their age and their walks of life. The elders of the youths tend to shrug off their comments and input on new subjects because they believe their system is correct. If it wasn't for the elders before me and my generation of 1992, then our world would be more sophisticated and safe. They failed to acknowledge simple mechanics. This is another reason why am creating Dimension Fusion. What is safer? A **Yellow 1.2** and **Black 4.9** Item with a Nutrition facts label that reads healthy? Or a **Yellow 1.2** and **Black 4.9** Poison Dart Frog. The Scholar would choose the **Yellow 1.2** and **Black 4.9** item that reads edible by the Nutrition Facts Label. I wouldn't pick any, for I have identified the mechanics that has been killing the masses. The answer to that question would be neither. None are safe to consume. For they are both labeled in **Yellow 1.2** and **Black 4.9**. The food item is just an evolved form of the **Yellow 1.2** and **Black 4.9** Poison Dart Frog. The Secret Masonic Order tends to look at

themselves as Gods and have evolved  [Colors](#) onto Edibles. Be careful what you eat. I would go  [Green 2.2](#). Speaking of  [Green 2.2](#), how could I forget about my escapade with Gonorrhea? I had intercourse unprotected in 2016 and caught a Venereal Disease. How I found out I caught this disease was when I began seeing a  [Green 2.2](#) substance oozing out of my penis. I didn't know until after I had unprotected sex. The  [Green 2.2](#) ooze meant to go get checked. My observations of  [Colors](#) are correct. Through our eyes, our bodies are evolving with what we see. Our sense of sight are creating  [Colors](#) in diseases such as my experience with Gonorrhea. Our sense of sight is evolving our body's biological structure. This means that what we learn from our reality, in turn evolves our biological structure. If  [Green 2.2](#) means to go in a traffic light, then of course  [Green 2.2](#) ooze means to go get checked. Isn't it amazing how our bodies are evolving with  [Colors](#)? I find it extraordinary. It doesn't surprise me that Green and Gonorrhea begin with the same letter. G. I caught Gonorrhea and through my creation of Dimension Fusion learned that a simple  [Color](#) has been physically encoded in our genetic makeup. My medical record can prove of my escapade with Gonorrhea. Onomatopoeia is defined as the formation of a word from a sound associated with what is named. With that being said here is something that's been puzzling me. What came first the word  [Green 2.2](#) or the word Grass? The Grass is  [Green 2.2](#), is it not? I believe the word Grass is a visual of the term Onomatopoeia. I was playing Dr. Robotnik's Mean Bean Machine and I remembered thinking about the Grass being  [Green 2.2](#). It seems as if the more education a person has, the more they lose their sense of reality and become out of touch with their surroundings. I didn't go to college, therefore giving me the advantage. Einstein dropped out of school at the Age of 15. I stopped paying attention in school at the age of 9. As children we are taught  [Colors](#). Even Vegetarians lose for they also read Nutrition Fact Labels. They read the Labels and miss the  [Colors](#). They tend to think that a Healthy Label ensures Health.  [Colors](#) should be indentified first. This is probably why they are killing off the animals slowly. Animals taught the natives through their  [Colors](#). They are trying to hide  [Colors](#). Thank god I stepped in. Animals taught me  [Colors](#), I intend to return the favor. Hospitals are spending losing money on patients while the slaughter houses grow richer. Biological Specimens are not for consumption. Dead or Alive. When a person is cut they begin to bleed.  [Red 1.1](#) Blood Cells coagulate and stop the bleeding. If that doesn't speak to the human that  [Red 1.1](#) means to stop then I don't know what else will. A Scab is the product of  [Red 1.1](#) Blood Cells coagulating. They create a  [Maroon](#) hue and stop the bleeding from continuing.  [Red 1.1](#) and  [Black 4.9](#) your okay jack comes into play.  [Red 1.1](#) and  [Black 4.9](#) equal  [Maroon](#). As you can see our biological make up is in balance with our reality. It is up to the student and reader to comprehend my science and it is up to the student and reader to study and grow from my literature that is Dimension Fusion. Foods that are packaged in  [Colored](#) labels must be checked. As sad as it is our reality has been dumped with edible meals that are washed with chemicals and deadly substances. This means every single package of food must be checked for those Nutrition Facts Labels are redundant and do nothing but fool the reader. Here is another example. Fire Hydrants are labeled as  [Red 1.1](#) because they stop fires. Get it? Memory cells from our ancestors who discovered  [Colors](#) are transferred to us. It is in our genetic codes. It seems that important memory cells are being wiped out through these chemicals and deadly substances that we consume, therefore the memory cells of our ancestors do not reach generations to come. These Masonic men are illiterate they cannot read but they know about  [Colors](#). It's a secret from The Secret Masonic Order. These illiterate Masonic men used  [Colors](#) to their advantage for they never comprehended the alphabet and the joining of letters that create words. The Secret Masonic Order used  [Colors](#) as a way of communication and a way of maneuvering around certain dangers and products of consumption. The constant consumption of these  [Colors](#) will ensure death. Vibrant  [Colors](#) are displayed

on animals and lets the unsuspecting animal know that the animal that displays the vibrant **Colors** is not a meal but is a danger and will kill them. The prettier the display of **Colors** from the animal the deadlier the animal is. The Masonic Secret Order has taken what was discovered by natives throughout the world and placed these **Colors** on packages of food. With this in mind that vibrant **Colors** kill, why would anyone consume a product that displays vibrant **Colors**. There is another saying with a snake that resembles the coral snake but the **Colors** of this snake are **Red 1.1** and **Black 4.9** which the masons give themselves reassurance that your okay jack. With the knowledge of the enemies' psychological weapon of choice [**Colors**], tactics will ultimately backfire and create a world with no dangers of consuming daily products. Always remember **Red 1.1** and **Yellow 1.2** means you're a dead fellow, but **Red 1.1** and **Black 4.9** states that your okay jack. Fast foods create diseases and death. Being a primitive being that relies on primitive actions and activities is a big problem when thrown into a community where the dimension of **Colors** are either forgotten or ignored. The term "When in Rome do as the Romans do" takes effect subconsciously and you will end up forgetting the past of **Color** dimensions and catching either diseases or sickness; Don't do as the Romans do. They all died. Due to the community's lack of understanding the ancient knowledge of **Colors**. **Blue 1.3** and **Yellow 1.2**, these two **Colors** I am very familiar with. See, my father used to be a janitor and the mop heads he would use were **Blue 1.3** and the handle of the mop would be **Yellow 1.2**. The **Color** Coded (C²) mop and mop head meant that whatever surface it touched it would rid of the bacteria. Killing off the bacteria. In the animal kingdom a **Blue 1.3** ringed octopus is **Yellow 1.2** and has **Blue 1.3** rings that decorate the octopus.









Blue Ringed Octopus

I've come to the conclusion that **Blue 1.3** and **Yellow 1.2** spells death. Poison Dart Frogs are also represented in **Blue 1.3** and **Yellow 1.2**. The **Color** **Green 2.2** also ensures death. **Blue 1.3** and **Yellow 1.2** equal **Green 2.2** therefore logic would tell you that death is the outcome. In prison they have a term for a secret murder and when someone has the "**Green 2.2** light" this means that the murder is on. When you see these **Colors** which are called the primary **Colors** **Red 1.1**, **Blue 1.3**, **Yellow 1.2** it reads as success [in my path]. I am the artist and the world is my canvas. I have been laying out the foundation of **Colors** without the notice of police. It isn't a crime therefore the law of **Color** remains. **Black 4.9** and **Blue 1.3** are used by the Police officers as a term for Black and Bruised. Just the knowledge of consuming a product with **Red 1.1** and **Yellow 1.2** compared to a product with **Red 1.1** and **Blue 1.3** could help you to live on. The Ancient Maya used to **Color** their sacrifices **Blue 1.3**, the reason for this and correct me if I'm wrong is because The Ancient Maya observed that when a person passes away their skin pigment becomes **Blue 1.3**. Hence why the Ancient Maya **Colored** their sacrifices **Blue 1.3** Knowing that **Black 4.9** and **Yellow 1.2** and **Red 1.1** and **Yellow 1.2** spell Warning and Death, gives the advantage of not consuming. **Color** Codes (C²) must not be ignored. Skyscrapers that met a horrible fate are **Color** Coded (C²).







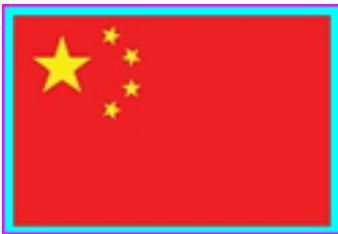





Hard Rock Hotel

The Hard Rock Hotel in New Orleans collapsed suddenly. These  Color Codes (C²) are being used to attack the people of the world.  Blue 1.3 and  Yellow 1.2 means death. Below I display  Red 1.1 and  Yellow 1.2. An expert who knows about the ancients and their  Colors would agree that the  Color scheme on the skyscraper above and on the next page below is terrifying and should be avoided.



China, The Vatican and Spain

The Flags of China, The Vatican and Spain display  Red 1.1 and  Yellow 1.2. Did you know the Twins were built with  Red 1.1 and  Yellow 1.2 materials? I mean The Twin Towers not George Bush Jr's Twins. Although the similarities are striking. The Chinese flag is  Red 1.1 and  Yellow 1.2, Twin Daughters pose in  Red 1.1 and  Yellow 1.2. Twin Towers that are attacked during the father's campaign who fathered those Twin Daughters were built with  Red 1.1 and  Yellow 1.2. Take a close look at George Bush Jr and you will see Asian genetics. Correct me if I'm wrong, but wouldn't one of those countries be the culprits of 9/11 attacks, due to their  Colors being displayed? It is 2019 and America is in a Trade War with China. The key word is Trade. China is America's biggest Trade partner. There are keys in-between Spain and China, and they are on The Vatican Flag. These keys might be the answers to 9/11. There are hidden answers to the questions that correspond to the questions of the time period where the hidden message appears, such as the keys on the flags. The message is from the Future signaling China and Spain's involvement in 9/11. I call it Forward Reversal. Forward Reversal will be discussed later in Section XIII Inter-Dimensional Travel. Messages are placed in the time period when it needs to be, such as the great mystery of who committed those terrible acts on 9/11. The culprits of 9/11 are discovered in the future therefore only leaving the most intelligent in this time period to enlighten the world of the countries who committed 9/11. I, Wilson Alzir Martinez am the most intelligent and I am the creator of the Forward Reversal Technique. Dimension Fusion places Past, Present and Future in a state where all can observe if they have the correct comprehension of how Past, Present and Future work. Time is just a measurement, therefore Time does not Travel but crossing between Dimensions is a reality. Why would I Time Travel when my company in the future sends faxes in the form of signs and symbols in my Time Period. Leaving no mistakes and criminals to get their crummy hands on my Dimension Fusion.



The Shakespearean Strategy

The attacks are somewhat a representative of mathematics. For example: two airplanes plus to buildings equals C-4. C-4 is defined as Command, Control, Communications, and Computers (US DoD) C4. Composition 4 (explosive). The original Dimension Fusion edit is in a Composition notebook. Composition is defined as a work of music, literature, or art. California is abbreviated as CA or C1. A is a mechanic; it is 1. Therefore leaving the script writers of theatre to reside in C1 or CA. CA is Composition A or Composition 1. C-1 doesn't exist. The existent Composition C families of explosives are as follows: C-2, C-3, and C-4. The lack of C-1 makes CA and Script writers an obvious target, therefore leaving C-1 (California) out. Composition C is 33. C is the third letter of the alphabet; C² is 33. CC. I call this strategy The Shakespearean Strategy. 9/11 was a scripted act. The Shakespearean Strategy is a term of scripted acts that affect the world. Hence why the word Composition is used as C-4. It is no surprise that C-4 was used in 9/11. C-4 was used in The War on Terror. The mechanic of C and 4 were used in this tragedy. George Bush Jr. also bears the mechanics of C-4. C is the third letter of the alphabet and D is the fourth letter of the alphabet. George Bush Jr. is the 43rd President of The United States. 43 and C-4 are related, it is numerology. C4 is an invention by the Chinese. C-4 is used in demolitions. Notice the mechanics of C-4 and 43. It is no coincidence that Dick Cheney's name bears the mechanics of 43 or C-4. D is the fourth letter of the alphabet and C is the third letter of the alphabet. Hence why he served the 43rd President of The United States. DC is 43 or C-4. Notice the mechanic of John Fitzgerald Kennedy; he was assassinated after the 34th president's campaign; 34 is C-4. If CA is Composition won (remember that won is one, 1) then wouldn't the X in Texas mean to Eliminate? My observations of the States names in America confirms that they are composed in a scripted fashion. C1 or California is where the script writers live. Texas or TX is where a president was eliminated. The mechanic of X is used in TX in its proper format. If this is true then I do believe NY is where the agenda of The New World Order began. I this

strategy State Code Decipher. For I am deciphering the States Codes. Decipher is defined as convert (a text written in code, or a coded signal) into normal language. I have discovered the codes that these tyrants have used against humanity. Could you imagine going to college for many years and being sent to work for the World Trade Centers. Now imagine you knowing what **Colors** meant. I wouldn't step foot into that building, I might as well look for another job. The **Colors** spell death, so why would I work in a place marked as death? If the Central Intelligence Agency knew about **Color Codes (C²)** then they would've known that The World Trade Centers were in danger and they would have intercepted. The **Red 1.1** and **Yellow 1.2** is displayed in the material that was used to build The World Trade Centers that were attacked on 9/11/01. Correct me if I'm wrong, but aren't the **Yellow 1.2** areas where the airplanes hit the buildings? Funny how China's flag displays **Red 1.1** and **Yellow 1.2**. This discovery enables the Central Intelligence Agency to intercept future attacks and communications between these terrorist. I, Wilson Alzir Martinez have discovered a secret that The Central Intelligence Agency missed; and I am sharing this strategy with The Central Intelligence Agency whom I am working for. They are running surveillance on me as I type this literature. I was never given a badge or special training but I did achieve a level that far exceeds their intelligence. With great power comes great responsibility. I have gained great power and I am using this power with great responsibility. **Red 1.1** and **Yellow 1.2** is defined as Death and was used against America by Politicians in the past. Displayed below is the **Color Code (C²)** used by Homeland Security. As you can see **Red 1.1** and **Yellow 1.2** is displayed as dangerous. The **Colors** of The World Trade Centers were built with **Red 1.1** and **Yellow 1.2**. **Red 1.1** and **Yellow 1.2** equal **Orange 2.1**

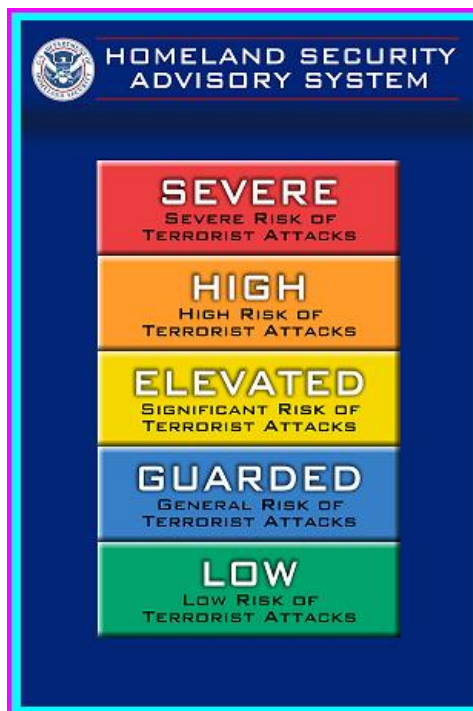

Red and Yellow

I advise surveillance be run on every skyscraper being built so this doesn't happen again. Skyscrapers can now be demolished depending on their **Color Codes (C²)** that were used during construction. Imagine having the power to identify which Skyscrapers are built for

terroristic plots by their **Colors** that were used in their build. This is the advantage that my Dimension Fusion hands to the world. **Color Codes (C²)** have been placed on packages and on buildings so that these beings can identify what is edible and what location not to venture in. these beings have laid out a formula only the elite recognize leaving the masses in a downward spiral. Nevertheless, the **Color Codes (C²)** will be studied as I have for the past two years. These labels of **Colors** would ultimately evolve into something far greater. Places, as you would find yourself dining in since you were a child such as McDonald's is labeled as Skull and Bones. **Red 1.1** and **Yellow 1.2** is the **Color** scheme of this place of dining, it mustn't exist. The dangers of food dyes also pose a threat. The food dyes **Red 1.1** and **Yellow 1.2** leads the disease called Cancer.



Jimmy Hoffa

Red 1.1 and **Yellow 1.2**. On July 30th, 1975 a famous politician by the name of Jimmy Hoffa disappeared. He was taken in this **Red 1.1** and **Yellow 1.2** home and was shot with two bullets to the back of the head. Frank Sheeran a blood relative of John Fitzgerald Kennedy was the hitman who committed the act. The knowledge of **Colors** is a secret mafia terminology that only the 1% knows how to read. How I gained this knowledge was through my ancestors teachings. The mafia stole the power of colors from my ancestors. If the Federal Bureau of Investigation and Central Intelligence Agency knew about these Colors, then the Twin Tower attacks that occurred on 9/11 would have never happened. On October 29th, 2019 I sent the faculty of Irving this document that teaches teachers **Colors**. I was confronted by 7 police officers the following day about my document that I had sent to the faculty. The Sergeant was angry because I mentioned **Colors**. He said I shouldn't be talking about **Colors**. Fuck him.



Invisible Manipulation

Dairy products such as Borden Milk is labeled as ■ [Red 1.1](#) and ■ [Yellow 1.2](#). This is a reverse psychological strategy used on the world. Our ancestors learned that the ■ [Colors](#) ■ [Red 1.1](#) and ■ [Yellow 1.2](#) spell death. These men of the secret masonic order have labeled nutritious substances such as milk as bad consumption. It is a subliminal strategy. It is no coincidence that this brand is bears the name of a murderer. Lizzie Borden murdered her entire household. Could it be possible that the Borden's met their demise through this revelation. With my Dimension Fusion it is possible to travel back in "Time" and hacking the Borden's family due to this present situation. The Borden's home is a bed and breakfast now. Breakfast with milk anyone? The secret masonic men has created a system of confusion. They claim Milk builds strong bones, but subliminally the ■ [Colors](#) ■ [Red 1.1](#) and ■ [Yellow 1.2](#) tell the subconscious to stay away from this substance.



Seatbelts

Seatbelts are meant to protect a driver, but psychologically affects the driver. Red means stop at a light. The reason Seatbelts are [Red 1.1](#) is to psychologically keep us from being safe. Our minds instantly Stop when thinking about wearing Seatbelts because of the ■ [Color](#). The ■ [Color](#) of the Seatbelts placed in Vehicles should be ■ [Green 2.2](#). ■ [Green 2.2](#) means to Go. Unfortunately, in this time period, only the elite know about this coding and set up the masses for their own self-extinction. ■ [Orange 2.1](#) and ■ [Black 4.9](#) have been used in this world as means of imprisonment. ■ [Orange 2.1](#) being a color that isn't used in our surroundings have made their way on to jumpsuits in prisons. Why? It is easier to spot ■ [Orange 2.1](#) when looking

for escapees and what not. Meteorologist use **Colors Codes (C²)** to signify how strong storms will be. **Colors Codes (C²)** represent the intensity of the Storms. These men hide behind no recognition in their names. I myself have found myself doing the same as I learned the secret technique of their power. I have no ties with any laws in a brotherhood, which leaves me clear to wipe out the competition that have been hiding behind these men that have names in the business such as locations like Hollywood and other locations that tie with fame and money. Now that we have ventured to the “Past” let’s get a move onto the “Future” which is known to me as of 2019. The Present. Three **Colors** sectioned off for each of the Three sections for each palette. Two Primary **Colors** Plus one Secondary **Color** will create what is called Traetary **Color**. The Men and Woman that hold Psychological weaponry at their disposal have created a system where the **Colors** that is widely known become a tool of misleading and manipulation. They have stripped the **Colors** from the world and placed the **Colors** on a flag representing a group. Groups that were looked upon in Babylonian times as a disgrace. The majority of men and women who grow up knowing that homosexuality is known as a sin. (I could give a fuck) since they have used it as a tool it must be reversed. Therefore they use the rainbow and the innocent homosexuals as a weapon to strip away the knowledge of **Color**. Don’t get me wrong not all homosexuals are innocent. There are men and women who prey on the homosexual communities as profit. There have been wars in the past and the way the soldier would know whom to kill was the way the apparel of the enemy would be wearing. Such as **Colors**. Confederates wore **Red 1.1**. The Yankees would wear **Blue 1.3**. They have stripped the **Colors** away and placed the **Colors** of the flag with rainbows as a way to have complete control over history. When one is disgusted with the Rainbow by innocent Homosexuality. The mind will forget how war is fought. Such as knowing thine enemies apparel. These men have used homosexuals as a tool of brainwashing to strip the knowledge of ancient past tribulations that have created what we are today. Ask yourself. Why are the **Colors** of the rainbow used for homosexuals? Is there another way to represent homosexuality? You will discover that there is another way in dealing with the innocent lives that are taken in the community’s worldwide that have been used as a manipulative tactic to strip away the knowledge that was gained by our ancestors and passed down for generations to receive an advance to another state of consciousness. **Red 1.1**, **Yellow 1.2** and **Blue 1.3** means a success by the ruling family. My family. Displayed below are diagrams that increase Dimension. The presentation of color is needed for Dimension. The student and reader will identify the **Colors** shown below. The Diagrams on the next page displays The Numerical Order of The **Color** and its position in The Order of **Color**. Shown below are The Primary **Colors**.

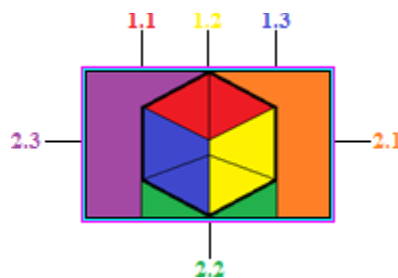







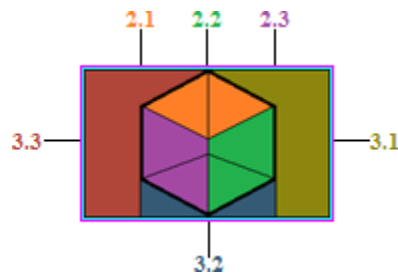







Primary Colors

 The Primary **Colors** consist of Three **Colors** **Red 1.1**, **Yellow 1.2**, and **Blue 1.3**. The Numerical Order of **Red 1.1**, **Yellow 1.2** and **Blue 1.3** are as follows. **Red** is **1.1**, **Yellow** is **1.2**, and **Blue** is **1.3**. With the Help of the Numerical Order and

Mathematical Law, we end up with Secondary  Colors which just like its predecessor it consists of the Rule of Three that Governs  Colors.







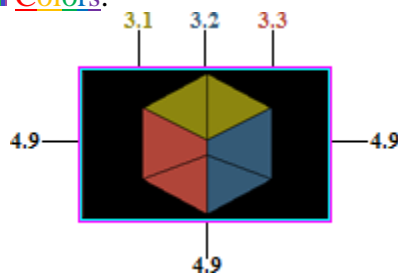













Secondary Colors

 The Secondary  Colors consist of Three  Colors  Orange 2.1,  Green 2.2, and  Purple 2.3. The Numerical Order of  Orange 2.1,  Green 2.2, and  Purple 2.3 are  Orange is 2.1,  Green is 2.2 and  Purple is 2.3. With the help of the numerical Order and Mathematical Law, we end up with the Traetary  Colors, just like its predecessor it consist of the Rule of Three that governs  Colors.



Traetary Colors

 The Traetary  Colors consist of Three  Colors  Gold 3.1,  Silver 3.2, and  Bronze 3.3. The Numerical Order of  Gold 3.1,  Silver 3.2, and  Bronze 3.3 are  Gold is 3.1,  Silver is 3.2, and  Bronze is 3.3. With the help of the Numerical Order and Mathematical Law the end result of the Traetary becomes  Black 4.9. Two  Colors from  Primary and  Secondary equal  Traetary. Three new  Colors from the Two  Colors that were added from both Primary and Secondary sum up The Traetary Set.

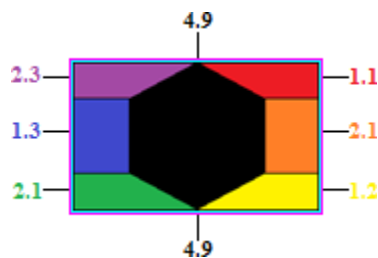

Black

 Black 4.9 will be the result of Traetary  Colors Combined. Traetary  Colors being Primary and Secondary  Colors combined meaning that  Red 1.1,  Yellow 1.2,  Blue 1.3,

■ Orange 2.1, ■ Green 2.2, ■ Purple 2.3, ■ Gold 3.1, ■ Silver 3.2, and ■ Bronze 3.3 are added to create ■ Black 4.9. The order must remain as is: ■ Red 1.1, ■ Yellow 1.2, ■ Blue 1.3, ■ Orange 2.1, ■ Green 2.2, ■ Purple 2.3, ■ Gold 3.1, ■ Silver 3.2, and ■ Bronze 3.3. The Primary ■ Colors alone create ■ Black 4.9 when added together. The ■ Colors ■ Red 1.1, ■ Yellow 1.2, ■ Blue 1.3 in an addition equation will sum up to ■ Black 4.9. The Primary ■ Colors add up to Secondary which makes the Primary ■ Colors Prime.

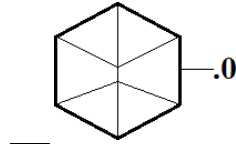

White

■ White .0 is the absence of ■ Color. White .0 is the creation of no ■ Colors present. As you can see from the image above none of the Primary, Secondary, and/or Traetary ■ Colors are present. This diagram informs the student and reader that there are no ■ Colors present.







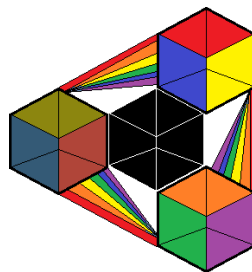



1%

The fact of the matter is that the world is mapped out in a secret fashion that only 1% knows how to read. Consider yourself an addition to the 1%. The ■ Colors of the map can show you who are allies and who are not.























My Combination

For some reason I have now been able to perform what we call Zoom with my vision, I can zoom in with my eyes. I practice this from time to time but as I begin to practice this technique more and more I begin to realize it is no mere illusion. On July 22nd, 2019 I was lying down on my mother's couch and staring at a deer trophy [I found myself babysitting three toddler deer's' one night. they are bipedal. Most adorable] and I began performing the "Zoom" technique with my eyes. This technique is fairly new to me but as I practice this technique I can switch in and out of "Zoom", I begin with relaxing and as I look around I can concentrate and somewhat bend my vision. I have heard about spoon bending but I have never heard about bending space with vision. At a state of rest, I can bend space. It looks as if the area is somewhat warped. It seems as if my intelligence is increasing daily and I can converse with MC (My Children) at any given point in time. I have observed as well that after being in the sun and have gone for a jog. Entering my home in a fairly dark setting I have observed my vision begins to flicker in motion in waves. Just as the cuttlefish demonstrates light shows my vision begins to emit waves. The  Color of my waves are  Dimension Fusion Blue. My sense of awareness has advanced so much that at a state of rest I can observe Millennia ahead of this time-period. Humans don't evolve passed the state that we are in. we remain the same. I saw a total of 5 species of royalty that were not human. The setting and please correct me if I'm wrong but I could've sworn the setting was the year 3,000,000. Again please when given the chance please correct me if I'm wrong I do not like leading my student and readers into confusion. Anyway back to my experience, The backdrop was that in space. Earth was the planet that was shown in the glass behind the figures. At one point one of the figures showed his fangs. I was not scared and I telepathically told him or her. Whom are you trying to scare? He walked towards me and greeted me by my name. I was communicating with family in the year 3 million. Before I observed these royal families who resembled reptiles and what not. My vision was as if I was staring down from a ship and looking at the earth as it grew larger and then smaller. By larger, I mean being side by side to earth and seeing its enormous size. And then eventually became smaller and we were next to the moon. The image presented by NASA is fake. The destination after we left planet earth was the moon. The moon is where I changed time-periods and went into the future. I have experienced "Dreaming" while being awake. I heard a voice, remember telepathic communication is key. The voice asked how can you dream if you're' fully awake. I have seen my "Future" self Millennia ahead of me being deceased. It is as if it were a motion picture. I am shown with armor and a bright sword. I know what it means; the hard part about this subject is that It took place on June 11th, 2019. This is new. The student and reader will stretch their imagination and begin to view "Future" "settings as I have. My technique is the first of its kind. Imagination is key. These Theoretical Physicists have been destroying the imaginative minds. Everything is crap nowadays in 2019. All the artist sing the same. All the painters paint the same. All the teachers teach the same. They are in a Matrix in which they never realized existed. The reality that these men and women created have placed their kind in a world with repetitive and ancient cycles. These men and women still worship ancient civilizations. In doing so they set themselves up for failure. They do not know what they worship. For all they know those ancient monuments were a foreground for their demise. Theoretical Physicist has destroyed their own kin's originality. These men and women only thought of themselves. Remember everything that I am noting down is 100% true. It is not a fable. The purpose of my Dimension Fusion is to advance your sense of awareness and reprogram your mind into an awakened state. You will begin to exercise Dimensions after reading Dimension Fusion. The awakened state of consciousness is the most incredible and astonishing view in my own experience I have traveled time-periods with no type of concentration or meditation. I call this state of mind *Instant Meditation*. Where the human or non-human species can find themselves going anywhere they

set their minds towards. The transmission from the setting you have in mind is instant. Instant meditation is mastered after countless practice. The Student and reader will now find themselves consciously aware of colors. The state of being color blind is a thing of the past. This book reinsures your safety and also advances your intelligence. With the knowledge of colors, the use of colors can now be used as a language. For example    spells out One. With  [Red 1.1](#) representing the letter O,  [Yellow 1.2](#) representing the letter N and  [Blue 1.3](#) representing the letter E. using colors as a language has no limitations. There are an infinite amount of  [Colors](#); therefore this means that there is an infinite amount of ways to communicate.





Crimsonology

The  [Colors](#) presented in the above reads a phrase. As I have stated previously,  [Color](#) Codes (C²) can be used as a means to communicate.  S  E  C  T  I  O  N  6 is what the Color Code (C²) represents above. Section 6 is the coded message that I have laid out for the student and reader. These  [Color](#) Codes (C²) are placed in plain sight for communication between men and woman. These  [Color](#) Codes (C²) are placed on television sets inconspicuously, as you may have noticed  [Color](#) Pixels make up the picture that is displayed for broadcast. This means that messages can be placed in plain sight for Classic Interception Advancement (CIA). The  [Color](#) Codes (C²) are used in areas and will do no harm in the area that these  [Color](#) Codes (C²) are used in. This technique is called Crimsonology. The perception of  [Colors](#) has changed for the student and reader. Their sense of reality is updated to another height of consciousness awareness. The student and reader has been informed and reprogrammed with the knowledge of  [Colors](#).  [Colors](#) in this world will once again rule as a means of preparation and determination, as  [Colors](#) create excitement and not hatred. Wilson Alzir Martinez's  [Colors](#) Codes (C²) will reign supreme as My Calculations (MC) have done so in the past. These "Pixels" or "Blocks" create images, and those images display hidden messages. C². The C in  [Color](#) represents the C in C² and the C in Code represents the ² in C².















Dimension Fusion

Another example of Crimsonology is displayed above. The C² also known as  [Color](#) Code is displayed in various amounts of  [Colors](#). Dimension Fusion is what the C² reads out. The reason for the sudden change in Einstein's Classic Mechanic that once was E = MC², is due to my reasoning and understanding of Einstein's equations. I have deciphered Einstein's E = MC² for what it was and I am changing the mechanic from Energy = Mass x Velocity x Velocity to anything I desire. I have used the same mechanics that the foolish equation E = MC² laid out. E = MC² has been destroyed and is now reborn in my likeness. Crimsonology changes the perspective of the saying "A picture says a thousand words" for many pixels create a picture.





A picture says a thousand words

The  Colors in this picture displayed above are      . The whole picture is a message. Each one of those Pixels is a letter. Depending on its position and hue determines the letter or phrase that it intends to display. This goes beyond the technology that the advanced men and women on the planet have in their possession. This code can't be broken, for it is an abstract form. Abstract form meaning it is between the receiver and transmitter. Try this exercise. Walk around the city and observe all the  Colors that are displayed all around the city.  Colors are beautiful. The Secret Masonic Order tried to use  Colors as a war strategy to make the world weak with  Colors representing homosexuality. I have created a war strategy myself and I call it Crimsonology. My strategy completely eliminates their use of  Colors. Observe my awesomeness as you take a look at life in a new perspective knowing that I, Wilson Alzir Martinez am the creator of the most secretive communication that is laid out in unlimited fashion. My codes even decorate your skies and your cities skylines.



W is for Wilson

With the study of The Basic Fundamentals of Dimension Fusion the perspective of the Renaissance Tower in Dallas, Tx changes as you change your Dimension of sight. Those X's transform before your eyes into W's and M's. Observe the W and M is displayed on the

Renaissance Tower. It stands for Wilson Martinez. As Above, So Below is displayed in Dallas, Tx with W and M. After my image, Wilson Martinez. The city of Dallas changes in  Colors as The Chameleon would. Now that I have established  Color Codes (C²) I will now begin to breakdown another coded mechanic that is C².



V²

The City of Dallas is painted in my image as skyscrapers of the tallest have been erected in my image. My Dimension Fusion is a success. I travel through Dimensions via Inter-Dimensional Travel and save the world. Funny how World begins with a W huh? I can't believe at the age of 27 I, Wilson Alzir Martinez learned how to Travel through Dimensions.



W

The W is a hotel in Dallas, Tx. it is in the midst of the many buildings in Dallas, Tx in my image.



W is the 23rd letter of the alphabet

The 23rd letter of the Alphabet is W, therefore naming this building in my land the 23. The buildings display My Conquer (MC) of the land. I have taken back my ancestors land back and am teaching beings who share the same intelligence as I. it's not my fault I'm Lucifer. Blame my ancestors. The reason W is the 23rd letter is because 1 is W. 123.



Obvious

1623 Main Street is where The Wilson Apartments can be found. 2016 is when I began my observations of Time Travel. 2016 is when I began communicating to the Future. Hence the 16 in 1623. 23 stands for W. hence why it is at 1623. With My Dimension Fusion I have traveled back and forth through millennia's and have painted the World in my image. From the Mayas of Central America to the Egyptians of Egypt. The snake stands. Notice the II fangs in the letter W. My ancestors were Serpentes. Displayed on the next page is C².

C²

Christopher Columbus

Before the battle between the ■ Red (1.1) Coats and the Americans took place. A secret society was formed under the Monarchs watchful eye. This secret society journeyed out into sea without informing the Monarchs. This secret society discovered North America. Members of that secret society began befriending the natives. The order of the secret societies gave native gifts and used

those gifts as an infiltration to their land. The natives taught them the secrets of the land. They showed these men from the secret society their useful weapons and tools. Such as the use of the poison dart frogs (Poison dart frogs are indigenous to North and South America, they do not exist in England.) Which are coded in ■ Yellow 1.2 and ■ Black 4.9. With the advantage of the forest secrets such as ■ Colors and a new home, the secret society began building bases in the new land they discovered under the noses of the Monarch. These men knew the ins and outs of the land which gave them full advantage. If war was ever to be brought out, they would have the advantage for they have studied and created an army with the native's blood. The Secret Masonic Order took over the land through diseases and war. Diseases entered the systems of the natives whose immune systems couldn't fight these foreign diseases. Making The Secret Masonic conquer that much easier. These men remained in America while the betrayers led the Monarchs away from America while it was being established under the secret societies order. These men did not like the rules that the Monarchs in England had and rebelled forcing them to look for a new land, these men were also considered filthy as they brought diseases to the land of the Monarchs. I'm sure the Monarchs discovered America as well and identified their Symbols as theirs. But the thing was that they never heard about this land before. They came to one conclusion. It was the rebels from their land whom never followed orders. War then broke out between the settlers and the Monarchs. The men of the secret society won the battle but never won the war. The Monarchs outsmarted the Americans for the Monarchs had intelligence on their side. They established the 13 Colonies with New England as one of them. In reality, The United States of America should be called New England. The Monarchs have been in battle with these inbreds for quite some time. These inbreds began their foolish takeover from England and when Royalty heard about their foolish ways they were punished. The inbred (secret society) became angry and formed a secret society. Hence why they kept America a secret. They bred with the land and created another race of humans. New England is America. I as a Knight of the Monarchs have kept a watchful eye of these fools and I have alerted the Monarchs. The Monarchs outsmarted the secret societies and created a truce with the Americans. They established a Democracy. Demo is defined as a demonstration of a product or technique. Hence why Democracy was chosen for the land. They created a judicial system for only brilliant men and women who know how to read. These members of the secret society act, they are as illiterate as they come. This is why actors have been trying to infiltrate the system of the Monarchs. Prince Harry has been infiltrated by a actress of America, therefore making the Monarchy infiltrated. This means that sooner or later an American with blood ties to Meghan Markle will rule the Monarchy. This has been a plan for Centuries. To infiltrate using Shakespearean techniques. The infiltrator goes by the name of Meghan Markle. The secret society use symbolism for their plans, they think because they use symbols it cannot be tried (tried as in off with their heads, not in a court of law.) by the Monarchs. This is incorrect for the Monarchs are literate and don't need the use for primitive language. Now that they know about the primitive language that these secret societies have been using affirmative action must take place. These illiterate men and women of the secret Masonic order think School is spelled with Sch, in reality it should have been spelled as Skool. They placed the ch because this illiteracy comes from the Busch bloodline. They show dominance with Ch. Here is the example of the symbolism used with the infiltrated on Meghan Markle. Meghan Markle is an actress who starred in a television series called Castle. The episode is called Sleeping Beauty. Sleeping Beauty is considered a princess. It is no coincidence she now lives in a Castle. Displayed on the next page is a still of Castle.



Monarch Mockery

Meghan Markle's character can be seen mocking the Monarchs in a role she had in Castle. She appeared on this show in 2012. She was married to a man named Trevor Engleson. She married the man in 2011. The number 11 is a classic mechanic of these fools of the secret society. Funny how the name Eng is in the name Engleson. Eng represents England. She divorced 1 year later. Prince Harry was set up on a blind date in 2016. The word "Blind" comes into play for the Monarchs are never informed of these types of treason. Queen Elizabeth II is Prince Harry's grandmother. With American blood now mixed with Royalty the Monarchs have found themselves in a check. Check is a termed used in Chess. Check is defined as examine (something) in order to determine its accuracy, quality, or condition, or to detect the presence of something. I as the Knight of the Monarchs made my move and have canceled that check that these foolish Masonic men have tried to commit. The American will be removed from the bloodline in the Future. Nice try. I'm sure Princess Diana wouldn't want her grandson being without a mother. Therefore Archie's bloodline will mate with Royalty once again. Fantastic name by the way. Reminds me of Archer. Meghan Markle was used as a pawn to infiltrate. She has no knowledge of this what so ever. As cooky as it sounds it is 100% legit. The reason this poses a danger is that it will eventually cause another war between American and England families. In chess a Knight moves in a L fashion. I am the creator of the L in Dimension Fusion the L is called a Fragmentary Shape. Below is my move. I am the Knight in Chess.

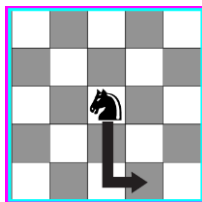

This is a checkmate for the Masonic order. I have checkmated the secret society of the world. For I made sure the Central Intelligence Agency ran surveillance on me before I checkmated the Masonic order. I am doing so now by creating Dimension Fusion. In Chess, Checkmate is defined as a check from which a king cannot escape. I have been observant and waited for my turn to strike. No one has ever heard of me therefore leaving my full advantage of a finishing blow to the secret Masonic order. Prince Harry, must also Check his Mate for the mate he chose to breed with was a tool for a modern infiltration of Royalty by the secret Masonic order. As a Royal member I demand death sentences. "Off with their heads!". C² has been a mechanic before Einstein made it famous. I have updated C² and destroyed the old rule of C². This literature discusses Past, Present and Future. The infiltration of a royal bloodline is in my Present. 2019. I, Wilson Alzir Martinez am "The Destroyer". We are under a silent attack. The illiterate are

being controlled by Colors and Alphabetical letters, the Bill Note that is displayed below has the 8th letter of the alphabet and the number 8. Each Bill Note displays Alphabetical letters and the number that each Alphabetical letters lands on. For example: a Bill Note with the number 1 displays a letter A, a Bill Note with the number 2 displays a letter B. The Alphabet that we are taught goes as far as implanting hatred in a subliminal form. H is 8. In the equation below I explain the hatred that is pushed upon us as a society at a young age. Placing the letter H in front of the number Eight creates Hate. It is a psychological move placed on the illiterate youth.

$$H + 8$$



$$\underline{H8}$$

These men have placed the ■ [Color](#) ■ [Green 2.2](#) as American currency. ■ [Green 2.2](#) means to Go. Hence why America is in a state of repetition. The currency must be changed to the ■ [Color](#) ■ [Red 1.1](#). In order to stop the state of repetition, the currency must change its ■ [Color](#) to ■ [Red 1.1](#). ■ [Red 1.1](#) means to Stop. I am the The creator of The Basic Fundamentals of Dimension Fusion. Now without further ado I present Equation of ■ [Colors](#). Section VI.

Section V



























Equation of Colors

Equation of Color



















Rainbow

I was in the shower and I was thinking about  Colors, for I have began teaching my eldest and second eldest daughter Dimension Fusion. My eldest daughter Angel is 8 years old and Genesis the second eldest is 6 years old. Joshua and Marco my nephews have also been reading Dimension Fusion, Joshua is 7 and Marco is 9. While in the shower I was thinking about the order of the Rainbow that was given to me in school as a child. Growing up I never looked at the order with an academic eye. Now that I have an academic eye I have realized why the order is. The reason the  Colors of the Rainbow appear as shown above is through mathematics.  Red 1.1 and  Yellow 1.2 equal  Orange 2.1, hence why  Orange 2.1 is displayed in between  Red 1.1 and  Yellow 1.2.  Yellow 1.2 and  Blue 1.3 equal  Green 2.2, hence why  Green 2.2 is displayed in between  Yellow 1.2 and  Blue 1.3.  Purple 2.3 is displayed as the last  Color.  Red 1.1 starts the pattern and  Blue 1.3 finishes the pattern, with these two  Colors combined;  Red 1.1 and  Blue 1.3 equal  Purple 2.3 hence why the color  Purple 2.3 is last. You may have learned the pattern academically as ROYGBV. Since I have began teaching my children Dimension Fusion my comprehension of  Colors has advanced. I have created the updated version of the Rainbow. It is displayed below.



Dimension Fusion

These  Colors displayed above are the updated pattern of  Colors.  Color Equations paint the town with wonderful exotic textures and values that shine immaculately in the night sky. Dallas is my canvas and the buildings in Dallas create the luminescence that glimmer and shine in the backdrop. Spectators from all over the world gather around and see the light show. Deep in Grand Prairie is where I lay out my foundation for the future and view my product become reality. The Basic Fundamentals of Dimension Fusion is a Program for the student and reader to be reprogrammed to their natural state and ultimately become in a higher state of consciousness. The student and reader must remember that the mind is like a computer and programs have been secretly pushed into our minds. This read will ensure the student and reader with a renewed mind. Equations with the utmost beauty come next replacing the complex patterns that is Dimension Fusion. We begin with  Red 1.1 and  Yellow 1.2. Why? When these Two  Colors are combined with the Law of Addition they create  Orange 2.1.  Orange 2.1 is the First  Color that begins the set of the Secondary  Colors. The Numerical  Color Equations above the  Color Equations will be explained later in the section. The student and reader will evaluate the Numerical  Color Equations before knowing what the  Color equations are. The student and readers mind will pick up my subliminal equation know as Numerical  Color Equations above the  Color Equation making the process of solving the Numerical  Color Equations that much easier to comprehend and solve. The mind is like a computer; with my technique of placing subliminal equations I am increasing the mind of the student and reader which in turn they will continue to breakdown each equation, even without the knowledge of what the equations mean. As the mind reads along each line it is calculating without the student and reader knowing. The mind is like a computer; always calculating, never resting. The student

and reader will review these Numerical **Color** Equations, and **Color** Equations at the end of the Text Booklet. The reason for this review is to enhance the student and readers comprehension, as I stated before with no trial and error there will be only error. Practice makes perfect and it is with the review that the student and reader can practice and test themselves as they begin to advance in Dimension Fusion. The Primary Set begins with the **Color** **Red** 1.1. By adding the Second **Color** of the Primary Set **Yellow** 1.2 the **Colors** advance into a new Set. This new set is called Secondary. The **Color** that begins the Secondary Set is called **Orange** 2.1. The **Color** Equations are represented in Sq2Ds shapes. The Numerical Equations are presented with numbers

$$1.1 \ a \ 1.2 \ /e/ \ 2.1$$



$$\color{red}{\blacksquare} \ a \ \color{yellow}{\blacksquare} \ /e/ \ \color{orange}{\blacksquare}$$

Orange 2.1

Ascension of Red and Yellow

The equation shown above is the solution for **Red** 1.1 and **Yellow** 1.2. The solution is the first **Color** in the Secondary Order. To solve **Red** 1.1 and **Yellow** 1.2 they must be added together. The equation and the solution for the first **Color** in the Secondary Order is **Orange** 2.1. Hence why the Secondary **Colors** begins with **Orange** 2.1.

$$1.2 \ a \ 1.3 \ /e/ \ 2.2$$



$$\color{yellow}{\blacksquare} \ a \ \color{blue}{\blacksquare} \ /e/ \ \color{green}{\blacksquare}$$

Green 2.2

Ascension of Yellow and Blue

The next **Color** equation is **Yellow** 1.2 and **Blue** 1.3. The solution of the first and second **Color** from the Primary order equals the second **Color** in the Secondary Order. The equation is **Yellow** 1.2 plus **Blue** 1.3 and **Yellow** 1.2 and **Blue** 1.3 equal the second **Color** of the Secondary Order. **Green** 2.2. Following this equation and solution comes the next equation solution which is none other than **Purple** 2.3. The Ascension of **Yellow** 1.2 and **Blue** 1.3 can be seen above in the diagram visually. The solution for **Yellow** 1.2 and **Blue**

1.3 is ■ [Green 2.2](#). Displayed below is the next Ascension. The Ascension of ■ [Blue 1.3](#) and ■ [Red 1.1](#). ■ [Blue 1.3](#) is the last ■ [Color](#) in the Primary Set; therefore ■ [Red 1.1](#) being the First ■ [Color](#) is added to create the next Ascension.

1.1 a 1.3 /e/ 2.3

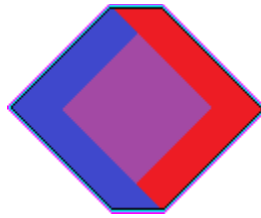

■ a ■ /e/ ■

[Purple 2.3](#)

Ascension of Blue and Red

The Solution for ■ [Red 1.1](#) and ■ [Blue 1.2](#) sum up to what is known as ■ [Purple 2.3](#). The Order remains the same just as before; starting with the First ■ [Color](#) and Last ■ [Color](#) in the Primary Order. As a child I was taught after reaching the last ■ [Color](#) or shape in a pattern, the next shape or ■ [Color](#) is the first ■ [Color](#) or shape that began the pattern. When reaching the end of a pattern the student and reader will know that the pattern begins with the first shape or ■ [Color](#). As a child, I learned this method. It shouldn't be difficult to comprehend. As I have just stated how I was taught in school; my technique of reversal is placed in the order of ■ [Colors](#). ■ [Red 1.1](#) and ■ [Blue 1.2](#) equals the third and final ■ [Color](#) ■ [Purple 2.3](#) of the Secondary set. Below I display for the student and reader the equation of ■ [Color](#) for the first ■ [Color](#) ■ [Gold 3.3](#) of the third set of ■ [Color](#). Traetary.

2.1 a 2.2 /e/ 3.1

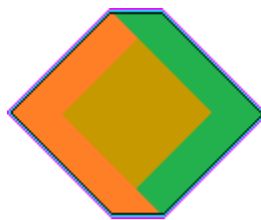

■ a ■ /e/ ■

[Gold 3.3](#)

Ascension of Orange and Green

Just as before adding the First and Second ■ [Color](#) in the Secondary order create the first ■ [Color](#) in the Traetary Order. It is indeed the Third set of ■ [Colors](#). ■ [Orange 2.1](#) and ■ [Green 2.2](#) is the equation and the solution is ■ [Gold 3.3](#). ■ [Gold 3.3](#) is the First ■ [Color](#) of the Traetary Order. The Rule of Three that governs ■ [Color](#) is recommended to find the accurate order of ■ [Color](#). The Second ■ [Color](#) in the set of Traetary is made up of the second and third ■ [Color](#) in the Secondary set.

2.2 a 2.3 /e/ 3.2

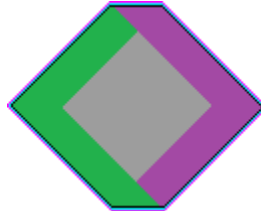

■ a ■ /e/ ■

Silver 3.2

Ascension of Green's and Purple

The Secondary Colors that are needed to create the Second Color in Traetary are Green 2.2 and Purple 2.3. Keeping the order "Classic" will remain in these equations to keep the order in line and repetitive with much success. Just as the pattern order before The Third Color in the Traetary Order is solved. The equation is shown below. Just as the Primary set. The first and third Color from the set that is to create the next Color in line for the next set Orange 2.1 is and Purple 2.3 they will be added together to create the third and final Color in the set Traetary. Just as before the first and last Color are added. "Pattern" is the keyword in this puzzling program.

2.1 a 2.3 /e/ 3.3



■ a ■ /e/ ■

Bronze 3.3

Ascension of Purple and Orange

The next Color to be created is done by adding up the Primary, Secondary and Traetary Colors. The sum is none other than the Color that is known to us as Black 4.9. The equation is shown below



1.1 a 1.2 a 1.3 a 2.1 a 2.2 a 2.3 a 3.1 a 3.2 a 3.3 /e/ 4.9

Black 4.9

The Ascension of Color





All the  Colors combined create the  Color  Black 4.9. Light is a different subject but I will go into further details on Light later in this section.  Red 1.1 and  Yellow 1.2 are to be combined to create the First  Color of the Second set. The next in the Order of Primary  Colors to be added are  Yellow 1.2 and  Blue 1.3. With the law of Addition  Blue 1.3 and  Yellow 1.2 create  Green 2.2 from the Secondary  Colors. When these Two equations are solved and the final solution is indeed where it needs to be; just as before the Second  Color pattern in the set of Traetary we use the Second  Color  Green 2.2 and the Third and final  Color  Purple 2.3 which created the Second in the order that is Traetary set; and that  Color is  Silver 3.2. Now on towards the next  Color in the Primary  Color Pattern which is indeed  Purple 2.3. You may be asking how can  Red 1.1 and  Blue 1.3 become as an equation if they are on the opposite side of the  Color Spectrum of Primary. Just like a pattern once you have reached the final shape or  Colors you then return to the original shape or  Color. For example  Red 1.1 begins the Pattern and  Blue 1.3 ends the pattern. Logic will see that when the pattern is complete if necessary repeats. Once you have reached the end of the pattern you begin with the original that creates the combination pattern. Hence why the next equation is  Red 1.1.  Blue 1.3 and  Red 1.1 are now the next in line to form an equation and solution.  Blue 1.3 and  Red 1.1 is the Beginning and End of the Combination Pattern will ultimately create the Final Secondary  Colors which is  Purple 2.3. To get the Third  Color and last  Color in the Third set of Traetary we use the same combination and rule we did when used for  Purple 2.3.  Orange 2.1 and  Purple 2.3 are combined to create the last  Color in the Third set of Traetary.  Bronze 3.3. With the Equations and solution finally solved for Primary we can now have what is known as Primary, Secondary, and Traetary  Colors Which follows.  Red 1.1,  Yellow 1.2,  Blue 1.3,  Orange 2.1,  Green 2.2,  Purple 2.3,  Gold 3.3,  Silver 3.2, and  Bronze 3.3. Traetary  Colors is the Third set of  Colors that Govern the Law of  Color Dimension. It is my understanding that in this "Universe", we live in a reality where the Rule of Three governs our World. You cannot have  Colors without Numbers. They go hand in hand. Without the understanding of the basic 1 2 3, you won't be able to excel in the "ABC's" of  Colors. For the Traetary  Colors to take form, one must use mathematical law of addition and fuse Primary and Secondary to form an equation. $1 + 2 = 3$. One Secondary  Color Plus one Primary  Colors will equal Traetary  Colors. Traetary Colors being  Gold 3.3,  Silver 3.2, and  Bronze 3.3.  Orange 2.1 and  Green 2.2 become  Gold 3.3.  Green 2.2 and  Purple 2.3 become  Silver 3.2, last but not least are  Orange 2.1 and  Purple 2.3 which become  Bronze 3.3. The subtraction equations are just as important as the addition equation. The Subtraction of  Colors are displayed below. Don't mind the Subliminal Numerical  Color equations that are displayed above the visual  Color equations represented by the Sq2Ds, these are placed to stretch the mind of the student and reader.

$$1.2 [s] 2.1 /e/ 1.1$$

$$\text{■} [s] \text{■} /e/ \text{■}$$

Red 1.1

Abatement of Yellow from Orange

The Second  Color of the Primary Set  Yellow 1.2 minus the First  Color of the Secondary Set  Orange 2.1 equals the First  Color of the Primary Set  Red 1.1.

1.3 [s] 2.3 /e/ 1.1

■ [s] ■ / e/ ■

Red 1.1

Abatement of Blue from Purple

The Third ■ Color of the Primary Set ■ Blue 1.3 minus the Third ■ Color of the Secondary Set ■ Purple 2.3 equals the First ■ Color of the Primary Set ■ Red 1.1. There are two paths that create ■ Red 1.1. The Second ■ Color of the Primary set ■ Yellow 1.2 minus The First ■ Color of the Secondary Set ■ Orange 2.1 equals the First ■ Color of the Primary Set ■ Red 1.1. The Second ■ Color of the Primary Set ■ Blue 1.3 minus the Third ■ Color of the Secondary set ■ Purple 2.3 equals the First ■ Color of the Primary Set ■ Red 1.1.

1.1 [s] 2.1 /e/ 1.2

■ [s] ■ /e/ ■

Yellow 1.2

Abatement of Red from Orange

The First ■ Color of the Primary Set ■ Red 1.1 minus the First ■ Color of the Secondary Set ■ Orange 2.1 equals the Second ■ Color of the Primary Set ■ Yellow 1.2.

1.2 [s] 2.2 /e/ 1.3

■ [s] ■ /e/ ■

Blue 1.3

Abatement of Yellow from Green

The Second ■ Color of the Primary Set ■ Yellow 1.2 minus the Second ■ Color of the Secondary Set ■ Green 2.2 equals the Third ■ Color of the Primary Set ■ Blue 1.3.

2.2 [s] 3.1 /e/ 2.1

■ [s] ■ /e/ ■

Orange

Abatement of Green from Gold

The Second ■ Color of the Secondary Set ■ Green 2.2 minus the Third ■ Color of the Traetary Set ■ Gold 3.3 equals the First ■ Color of the Secondary Set ■ Orange 2.1.

2.3 [s] 3.3 /e/ 2.1

■ [s] ■ /e/ ■

Orange 2.1

Abatement of Purple from Bronze

The Third **Color** of the Secondary Set **Purple 2.3** minus the Third **Color** of the Traetary Set **Bronze 3.3** equals the First **Color** of the Primary Set **Orange 2.1**. There are two paths that create the **Color** **Orange 2.1**. Just as there were two paths to create **Red 1.1**. The Second **Color** of the Secondary Set **Green 2.2** minus the First **Color** the Traetary Set **Gold 3.1** equal the First **Color** of the Secondary Set **Orange 2.1**. The Third **Color** of the Secondary Set minus the Third **Color** of the Traetary Set **Bronze 3.3** equal the First **Color** of the Secondary Set.

2.1 [s] 3.1 /e/ 2.2

■ [s] ■ /e/ ■

Green 2.2

Abatement of Orange from Gold

The First **Color** of the Secondary Set **Orange 2.1** minus the First **Color** of the Traetary Set **Gold 3.1** equals the Second **Color** of the Secondary Set **Green 2.2**.

2.3 [s] 3.2 /e/ 2.2

■ [s] ■ /e/ ■

Green 2.2

Abatement of Silver from Purple

The Second **Color** of the Traetary Set **Silver 3.2** minus the Third **Color** of the Secondary Set **Purple 2.3** equals the Second **Color** of the Secondary Set **Green 2.2**. There are two paths to create The Second **Color** of the Secondary Set. **Orange 2.1** minus **Gold 3.1** and **Silver 3.2** minus **Purple 2.3**

2.1 [s] 3.3 /e/ 2.3

■ [s] ■ /e/ ■

Purple 2.3

Abatement of Orange from Bronze

The First **Color** of the Secondary Set **Orange 2.1** minus the Third **Color** of the Traetary Set **Bronze 3.3** equals the Third **Color** in the Secondary Set **Purple 2.3**.



Black 4.9

The Last **Color** but certainly not least, The **Color** **Black 4.9**. This **Color** is very special. More than one **Color** is needed to subtract from **Black 4.9** to equal the **Color** that is desired. For example. **Black 4.9** minus **Orange 2.1**, **Yellow 1.2**, **Green 2.2**, **Blue 1.3**, **Purple 2.3**, **Gold 3.1**, **Silver 3.2**, and **Bronze 3.3** equals **Red 1.1**. **Black 4.9** is created by every **Color** that is displayed in the equations above. Here is another example, this time **Red 1.1** joins the equation, however I leave a **Color** out of the equation because the **Color** I am leaving is the solution. The next equation is as follows **Black 4.9** minus **Red 1.1**, **Orange 2.1**, **Yellow 1.2**, **Green 2.2**, **Purple 2.3**, **Gold 3.1**, **Silver 3.2**, and **Bronze 3.3** equals **Blue 1.3**. By subtracting certain **Color** from **Black 4.9** the possibilities are endless. When dealing with the equation of **Colors** it may seem repetitive so I have created a new way of adding and subtracting colors. The Primary **Colors** in this new form of equations are as follows, **1.1 = Red**, **1.2 = Yellow**, and **1.3 = Blue**. The Secondary **Colors** in this new form of equation are as follows. **2.1 = Orange**, **2.2 = Green**, and **2.3 = Purple**. The Tertiary **Colors** in this new form of equations are as follows. **3.1 = Gold**, **3.2 = Silver** and **3.3 = Bronze**. The equations below are just a few examples of my advancement of **Color** Equations. They are called Numerical **Color** Equations. **Color** Equations are displayed with Sq2Ds'. Numerical **Color** Equations are displayed with Constants/Integers. It is imperative for the student and reader to examine each Numerical **Color** Equation and evaluate each Numerical **Color** Equation. The Numerical **Color** Equations have been displayed in a literacy form and can be studied at the pace one chooses. The object of these Numerical **Color** Equations that I have created are to stretch the mind of the student and reader and increase their sense of mathematics with **Colors** in a literacy form. By literacy I mean equations of **Colors** with Numbers and Letters. The following equations are a few examples of Ascension Equations (Addition) or Abatement Equations (Subtraction). Abatement is defined as the ending, reduction, or lessening of something. Ascension is defined as the act of rising to an important position or a higher level. Below displays Addition (Ascension) and Subtraction (Abatement). I use the term literacy to explain the form of the equations. If I used the term Word Equation it seems quite dumbed down. I prefer the word Literacy Equations to explain the form these equation.

1.3 [s] 2.3 [e] 1.1

Red

1.3 [s] 2.2 [e] 1.2

Yellow

1.2 [s] 2.2 [e] 1.3

Blue

1.2 [a] 1.1 [e] 2.1

Orange

3.2 [s] 2.3 [e] 2.2

Green

2.1 [s] 3.3 [e] 2.3

Purple

1.2 [a] 1.1 [e] 2.1

Gold







































2.2 [a] 2.3 [e] 3.2

Silver

2.1 [a] 2.3 [e] 3.3

Bronze

Ascensions and Abatements











The student and reader must observe the period (.) that separates the Set and  Color. The 1. In 1.1 represents the Primary Set of  Color. 1 is Primary. The .1 in 1.1 represents the First  Color in the Primary Set.  Red is 1, The 2. In 2.1 represents the Secondary Set of Color. 2 is Secondary. The .1 in 2.1 represents the First  Color in the Secondary Set, and The 3. In 3.1 represents the Traetary Set of Color. 3 is Traetary. The .1 in 3.1 represents the First  Color in the Traetary Set of  Colors. My Dimension Fusion Advances the  Color Equations and creates a smooth technique of solving  Color Addition and Subtraction. The  Colors in these Solutions are the First  Colors of their Sets.  Red (1.1) is the First  Color of the Primary Set,  Orange (2.1) is the First  Color of the Secondary Set and  Gold (3.1) is the First  Color of the Traetary Set. Yellow (1.2) is the Second  Color of the Primary Set;  Green (2.2) is the Second  Color of the Secondary Set and  Silver (3.2) is the Second  Color of the Traetary Set.  Blue (1.3) is the Third  Color of the Primary Set;  Purple (2.3) is the Third  Color of the Secondary Set and  Bronze (3.3) is the Third  Color in the Traetary Set. My advancement of  Colors will increase the consciousness of the student and reader. The student and reader must observe that  Color Equations is an easy subject that anyone can adapt to.  Black is 4.9.  Black is the last but certainly not least. 4. In 4.9 represents the Black Set, the .9 in 4.9 represents all the  Colors. Science states that White is the solution of every  Color combined. That Black is the absence of  Color. In reality, it is indeed the opposite. In reality that is true. The reason why I see this as it is; is because for starters on the Computer when you add every  Color together forms white. But with Real  Colors, in reality, all  Colors combined become Black.

1.1, 2.1, 1.2, 2.2, 1.3, and 2.3

Rainbow's Numerical Order

1.1, 1.2, 1.3, 2.1, 2.2, 2.3, 3.1, 3.2, 3.3, and 4.9















Dimension Fusion's Numerical Order

When experimenting with  Colors one will notice that when any  Color put on a blank sheet of paper the  Color is shown with no problem to the human eye. Giving the fact that White is the absence of  Color. Do the same with a  Black 4.9 sheet of paper and the  Color is hardly visible. Meaning that  Colors are adding to  Black 4.9. Black is every  Color combined into one. The  Color of the sheet is "Black". Making it hard for the  Color that is being placed on the sheet hardly visible.

4.8













Grey

 Grey 4.8 is the absence of one  Color. If 4.9 are all  Colors combined than  Grey 4.8 has found itself lacking one  Colors. The equation for Grey 4.8 is $4.9 - .1$, the reason for this equation is to display the absence of one  Colors.  Grey 4.8 is the equivalent to all nine  Colors minus one  Color. Funny thing about  Grey 4.8 is that it doesn't matter which color is absent. White .0 plus  Black is 4.9 equal  Grey 4.8, this means that White .0 eliminates a  Color giving no discrimination to which  Colors is eliminated.

.0



White

White is the absence of  Color. White has no  Color hence why the Numerical Order is 0. Black is all  Colors combined. I remember being taught in school that White was all  Colors combined and Black was the Absence of  Colors. If you ask me they denote Black in this manner to place racism. Saying that Black is the absence of  Colors is like saying Black has no soul. As if it were an abomination. This is not the case. I have done my own observations and studies for 20 years and I have come to the conclusion that White is the Absences of  Colors. How interesting, in such a short time the world forgot about  Colors. I'm not going to lie for quite some time I was disgusted by the Rainbow for they had made the Rainbow into the homosexual flag. I am no homosexual and I find homosexuality an abomination. So I see how easy it is for a nation and the world to be molded from Ancestry knowledge of  Colors to a world without. Complete darkness. Light is a Different subject because as you may have observed Light shows the  Colors from one end of the spectrum to the other. Science and Mathematics can be fused once the Basics when each have been learned. Which I have done so and have increased my understanding of Life itself. I as the Teacher of The Basic Fundamentals of Dimension Fusion am doing my duty as a Teacher. With persistence, determination and dedication I created these calculations to reprogram the mind of the student and reader. These calculations increase the conscious awareness of the student and readers depth of perception and Dimensions. I mastered the technique of calculating and the art of teach, at the age of 26 I created Dimension Fusion and at the age of 27 a year later I mastered my technique with no effort. By understanding One, Two, and Three I excel above my Peers and Their Elders. You can excel and go above and beyond when understanding the foundation of what was learned as a child.  Colors Create Balance. Not Chaos.

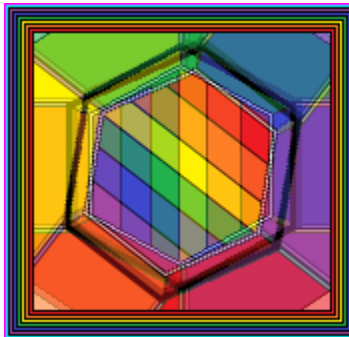

Coloration

Section VI

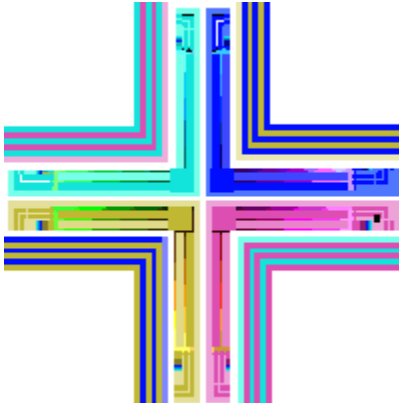

Inversion of Colors

Inversion of Colors

This Section, the student and reader will find themselves in a view of the inverted states of **Colors**. The Inversion of **Color**. The sets are displayed as the following **Red 1.1/ Green 2.2**, **Yellow 1.2/ Blue 1.3**, **Orange 2.1/ Silver3.2**, **Green 2.2/ Purple 2.3** and last but not least **Black 4.9/White.0**. To see the inverted states of **Color** with the naked eye. Try this exercise. Performing the exercise without the use of colored light is on the safe side. Light damages eyes. Place a **Green** sheet of paper in front of your eyes or place it on the table. Preferably in front of your eyes and focus your eyes for a few seconds on the **Green 2.2** sheet of paper. After you have focused on the solid **Green 2.2** sheet. Blink. Or close your eyelids. Your vision will be the inverted state of **Green 2.2**. Which is **Red 1.1**. Below is a diagram of the inversion exercise that the student and reader can perform. A perfect example of misuse of the **Color** inversion test with the naked eye would be that of one staring at the sun. Performing that task will result in the solution of the diagram below. The sun has a **Yellow 1.2** Hue. When one closes their eyes after viewing the sun a **Blue 1.3** hue begins to settle in the vision of one's perception. The inverted state of **Yellow 1.2** is shown after gazing at the sun. Which is **Blue 1.3**. Do not attempt. It will damage your eyes. Don't be a fool and damage your eyes. I have observed as I laid down on the couch with my feet up in a relaxed state of body; as I stared at the Black fan above me I closed my eyes and as I began to focus on my inner part of my eyelids I observed the inverted state of black which is white setting into my vision. A white outline with the shape of the same fan began to emerge. The part of the fan where the light bulbs are placed becomes black. When I closed my eyes it became white. Figure S shows Reality. *Figure W* shows Inverted State of Reality

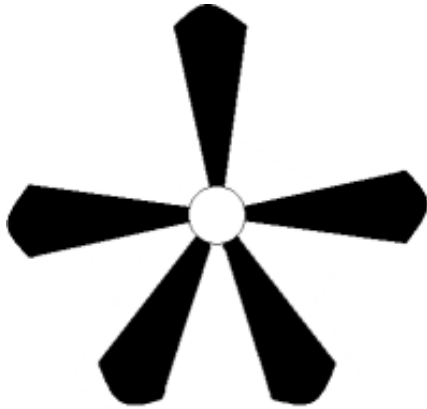

Figure S

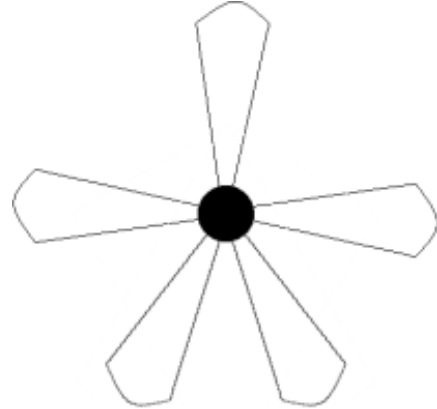

Figure W



The inverted state of Black is White



The Inversion of Colors



The inverted state of Red is Green









The inverted state of Yellow is Blue



The inverted state of Orange is Silver/Greece



The inverted state of Green is Purple

The Inversion of  Colors will aid beings that do not resemble humans. Beings whose genetic code might have developed a sense of sight where  Red 1.1 is  Green 2.2 and  Blue 1.3 is  Yellow 1.2 . (I have faith in the Reptoids) The Inversion of  Colors will aid those beings in this reality. There are beings on this planet that have a different perception. For example a dark photograph presented with a value of dark, will be presented in a value of light for the being who the photograph is presented to. the image below is of a blackhole.



Hueman Percieved

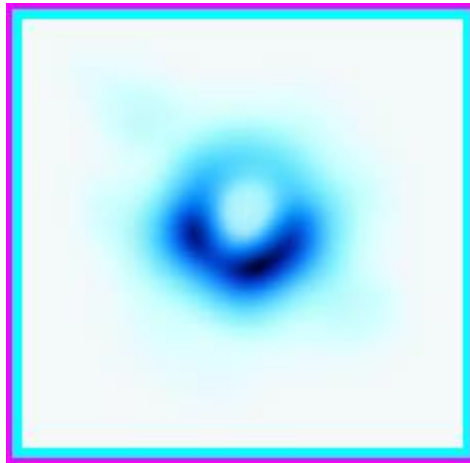

The image above is displayed in  Colors we Sapiens perceive as normal. Notice the Dark value that the image presents to the observer. This image is presented in a value that favors Dark. Now if I presented this to an EBE (Extra-Biological Entity) than the Entity might be blinded by its value for it is presented in a Dark value. The Dark value that I present to the EBE is viewed that

similar to a Human (Sapien) staring at the Sun. Below is the inverted state of the image in the previous page.



















EBE Perceived

This image above could alone could blind an EBE. It is presented in a dark value to us Humans but it is perceived with a light value to the EBE. My science of Dimension Fusion enables Humans and EBE's to communicate in a proper fashion without war. I am enabling the co-existing breeds to communicate with a peaceful manner. If an EBE presented me this image and told me it was his home world I wouldn't be able to identify its Dimension. We are two different sides of spectrums. The Inversion of [Colors](#) exercise the mind and advance the way we perceive [Colors](#) in our world. The inverted state can reverse things such as subliminal in areas where our eyes are focused. Subliminally these [Colors](#) will work a state of our eyes and brains that are only functioning while the body is at rest. Hence why we can only see the [Colors](#) while our eyes have been shut after viewing whatever [Color](#) was last viewed. While at a state of rest our body is working and storing the information we have been perceiving when we are awake. Do you think that these [Colors](#) are of the subconscious mind? That this is how our subconscious minds pick up subliminal and stores them in our subconscious minds? If this is true about the subconscious and how subliminal messages are broken-down than the advantage is thus achieved with the inversion of [Colors](#). Notice that the inverted states are shown when the eyelids are closed. A sleep state in which we perceive these [Colors](#). Subconsciously we do not think of what has been viewed through our eyes only what we perceive as normal. Normal [Colors](#) have been taught to us as children. Never the inversion state of [Colors](#). A common theme in physics colors are. [Colors](#) are the Basics of Physics. The student and reader please be advised that inverted states of [Colors](#) are very important in excelling the obvious. The inverted States of [Colors](#) will be the essence of what is known as Inner Dimensional Travel. It will be discussed in Section 6. The Inversion of [Colors](#) calculations are derived from the First [Color](#) of the Primary set and the Inversion of the Primary's First will be the Second [Color](#) in the Secondary Set of [Colors](#). The Inversion of [Colors](#) is simple to comprehend. The First [Color](#) in our spectrum is known to us as [Red 1.1](#). The inversion of color is the opposite [Color](#) of what is being inverted. [Green 2.2](#) appears as a result of [Red 1.1](#). [Green 2.2](#) is the only [Color](#) that appears to be present from the Secondary [Colors](#) Primary Color inversion states are represented as shown in the following order. [Yellow 1.2](#) = [Blue 1.3](#) and [Red 1.1](#) = [Green 2.2](#). I wonder what Selena's favorite [Color](#) issss? The reality is anything that is consumed in a colorful package spells death. It is important to change this form

of distribution by analyzing the ingredients in the foods we consume. Knowing that these  Colors hold ancient secrets will help a long life and will create a future with intelligence like never before. The knowledge of these  Colors will indeed increase your aspect of life and will open new doors to the imagination that has never been reached. The student and reader will grow wise in life. It is imperative to study  Colors as a whole. The more studies done with no harm to animals will increase the cycle of life to its full potential.

 [a]  [e] 

Ultimate 1

 Colors will evolve into new technology that will immensely rock the planet. There is no denying that  Colors in our lives have helped us in managing our daily routines such as transportations. The  Colors of taxi cabs. The stop signs on the streets. The traffic lights that save countless lives. As you can see there is no second-guessing that  Colors help in the cycle of life. It went from  Colors on an animal to alert us of its dangers to  Colors in traffic lights to alert us of caution.  Colors on the packaging were only known to the "Elite" families of the world. The quicker the student and reader reprogram what was lost by countless brainwashing through the media. The quicker their ancestor's wise discoveries will begin to come back. Bioelectrical energy seems to be an advancement amongst sapiens that can send data back and forth through time through the simple study of life. Bioelectrical energy is indeed a fact and will be brought up as it was previously discussed during the preface In this subject. Be aware  Colors evolve as we do. The inverted of states of  Colors will evolve us into new levels of consciousness like never before. New  Colors from a new spectrum will be discovered. There are countless techniques what colors can do in our realm. As the student and reader may have observed there is an abundance of different styles to pick up on with the  Color spectrum. Imagination will become mastered when the study of styles have been finished. Once the technique of subliminal  Colors such as the  Colors that are inverted are discovered will we be able to teach the children of new ideas and achievements that will increase there neoteny (Curiosity) to their full potential. The states of  Colors will be broken-down once the goal is met with the student and reader of what they have just analyzed. When the analysis is suitable with their mental status then it is wise to move forward to the next section which is titled Recurrence Dimension. Recurrence Dimension is the Dimension of Frequencies that move in and out of consciousness and subconsciousness. It is best if the student and reader study and do their experimentation on the Dimension of  Color before moving onto the next Section. The subconscious mind stores information for later so that when the conscious mind forgets on that subject that was picked up on the subconscious mind will remind the conscious mind on what was forgotten. With so many distractions in this world, the brain has evolved so that forgotten data is stored. The subconscious mind is a very important part of the human anatomy. It reminds us when we are wrong when we don't know if we are right. When we don't know, the subconscious mind acts out by triggering nerves that send our hands to scratch at the body. "Scratch That". Primary  Colors are used in to show that the student and reader of this subject is number one. Primary  Colors are the beginning and end. Primary colors are used to show the success of what was subjected. The Dimension of  Color begins and ends with Primary. The Primary set is what begins the Dimensions and they are mathematically added to create the Secondary and Traetary and Black. The Dimensions ascend when mathematics is fused with the Primary. The reprogramming of the mind is a subject that anyone can pick up on. The student and reader have now been shown a subject that amplifies Dimension and the student and reader

are now reprogrammed to know what **Colors** are harmful and what **Colors** are not. Science literacy is a common way to prove that ones who have been leading in a false manner such as Albert Einstein and Michio Kaku and others in that list wrong. The student and reader have picked up a new type of Science literacy that has never been produced. It is a seed in the underground system of the earth just waiting to sprout into our atmosphere. The reprogrammed mind of the student and reader will see colors in a new retrospective way. This is underground science. The Classical Interception Advancement (CIA) has been received to the reader and the student in the preface of this read and will continue to reprogram their mind by continuing the read. After this section has been digested by the student and reader they will take the next step in the evolutionary process and will practice the art of Telepathy. It is up to the student and reader to comprehend such advanced mathematics and biological studies of the environment around them and it is up to the reader and student to comprehend how to use Vibration Telepathy. The reprogramming of the mind is a concept that has been controlled and studied, as I stated before it is up to the student and readers comprehension on how they will manifest their mind to be reprogrammed. Now that Dimensions of **Colors** and Equation of **Colors** has Reprogrammed the mind of the student and reader, we know journey into Frequency Dimensions. Recurrence Dimensions in this next subject. We venture into the advanced methods that is Telepathy. Telepathic Communications TC can be a method used as advanced communications through Dimensions a Thought Transference if you will. Communicating through Dimensions is what the student and reader will pick up in the next Section. This Section was Equation of **Colors**. Recurrence Dimensions follows. Serpentes.

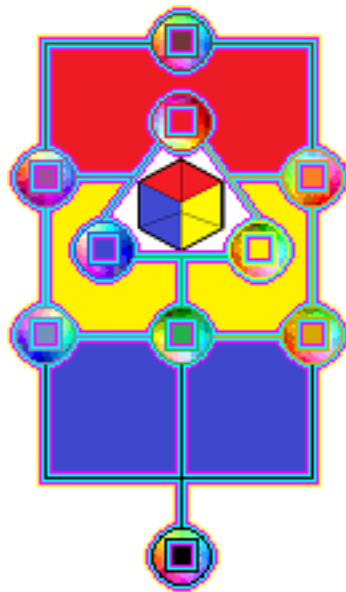

Wilson Alzir Martinez's Colors Fusion

Section VII

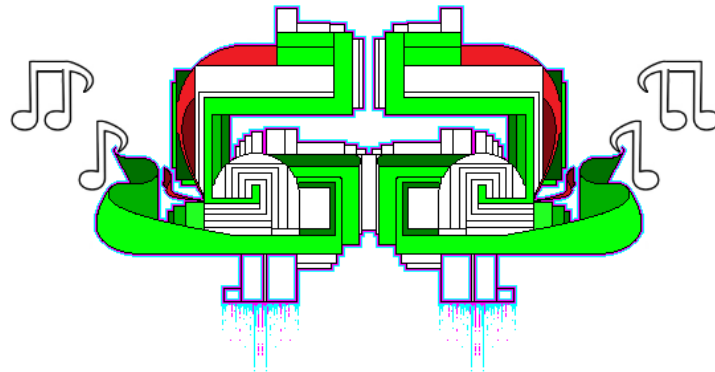

Recurrence Dimension

Recurrence Dimension

Two Fangs from the Predator strike down as quick as two lightning bolts. The predator gains expertise in survival. The Viper has made its way out of the pit. The Rodents have been devoured and laid to rest in the stomach of the Predator. It ventured into a world filled with darkness and silence and has emerged out the gloomy setting into the colorful world that is filled with beauty and music. Soaring high above the Viper in the sky is an Eagle, out for a game of hide and seek. The Eagles children are singing in harmony for a breakfast fit for royalty. With the Bird's' eye view (This means the Electric Bombs carrier on its side. The Eagle sets its sight on the ground below. Worms squirming out of their burrows emerge out of the wormhole. Children singing give the persistent parent strength as it dives into the depths of the grassy plains. A playful game of hide and seek has become a game of survival and has set the match in the Eagles favor. Vibrations begin to dance in the earth's' surface as Worms begin to break free. Stephen Hawking was a man who was against the world. His Transcendence into the Holographic Universe met his fate abruptly as I made my entrance. A design that was grand indeed in his perception was no match for My Calculations. The "Super Genius" known to the world as Stephen Hawking was born in Oxford, United Kingdom. This meant from the moment he was born he was born a nazi. His father fought in WWII. Ties to the Army at a young age Stephen Hawking had. I picked up a book called Black Holes and Baby Universes and Other Essays. The illiteracy of the book is shown in the title of the book for the book should have read as Black Holes, Baby Universes and Other Essays. Note the comma is used in my observation and checking of Stephen's Hawking's Grammar. November of 2018 I found myself reading the entire book at Irving's Public Library located at 601 Schulze Dr, Irving, TX 75060. It is in this book that Stephen Hawking explained $E=MC^2$. The equation reads out as Energy = Mass x Velocity x Velocity. I observed that Velocity doesn't start with a C as shown in the equation. It was at this moment that Einstein became my Prey. This year, 2019 I went back to the library and ripped out the spine of Stephen Hawking's book, Black Holes and Baby Universe and Other Essays. April 2019 I made my way to the same library and ripped out the spine of Einstein's "The Special and General Theory of Relativity." I then sat down and typed up every word of Einstein's "The Special and General Theory of Relativity" and I named the document The Obliteration of Time and Space. I destroyed the Space-Time Continuum in Three Weeks. I took my time and analyzed Einstein's calculations and I conquered his world. There are cameras in the library and I can clearly be seen walking in and out of the library. I had to steal the books, for I didn't want anyone reading Einstein's or Stephen Hawking's trash. Their ancestors conquer lands steal, and burn books. Ripping out the spine out of those books is the equivalent to burning their literature. If I had the time I would go to every library and rip the spines out of their literature so that no evil shall roam the earth. Sadly I do not have the time for I am working on The Basic Fundamentals of Dimension Fusion. Einstein and Stephen Hawking are Nazi. They pay Allegiance to Adolf Hitler. In this Section, the topic of discussion is Frequencies and The Holographic Universe and how to communicate through the Holographic Universe. Vibrations/Frequency Dimensions are easier to comprehend. I have three years of experience with Music. I attended Music class when I was eleven until I was fourteen. I was fluent in Bass. I played amongst the Brass family. 6th Grade was when I began my lessons and learned how to play an instrument. I chose to play the Trombone. Wasn't my choice but that's all that was left. Even if it was the only option I had, I would've picked up the same instrument without a doubt. Since I took band class it made Music a language I could speak, leaving the comprehension of Music that much easier to comprehend for me. I consider Music being the most influential technology out of every other tech in the world. It destroys and creates. Music is Life. It has been

used in the past as a weapon and to heal. It has been around us since ancient times. Even before we were born. When we were in the womb we experience Sound. Sound has been around us before conception. When you think about Music, you never think about the communication process that takes place between the written document the composer is studying and ultimately produces. The notes that are labeled with letters of the alphabets are in fact a language and can be studied and composed. A free mind reins the world. There are no limits to a free mind. Creation and Destruction become part of the free mind. Thought Transference between the Holographic Universe and our reality is now fact. Thought Transference is the first step to Inter-Dimensional Travel (Time Travel). Frequencies are what travels quicker than light. I can receive messages from the future via T² Thought Transference and speed up the time in my present state. It's the first step to Time Travel (Inter-Dimensional Travel.) I am creating the telepathic communication that goes back and forth through Dimensions and as I might add it is a very tricky subject, but can be picked upon once taking notice of Music Notes if one wants to communicate through Music. I was sitting down next to my mother, she was watching a video. The audio that was being played in the video was "When the saints go marching in" while the tune was being played I couldn't help but notice the music notes speaking the lyrics. It was an instrumental meaning no vocals were present in the tune. Although there were no vocals present, the instruments read aloud the lyrics brilliantly Music Notes form equations. The mind breaks down equations with the help of the consciousness. Depending on the language you speak makes out the Music Notes to your comprehension. Let's face it the song that is displayed below in a different language would not be broken down in the consciousness the same as the equation below. The equation below is the beginning of "When the saints go marching in". Music Notes create equations and another means of communication. It seems that communicating through vibrations that music notes project towards the transmitter and receiver is a language that I, Wilson Alzir Martinez have discovered, it is a new language. Below is an equation created by Music Notes.

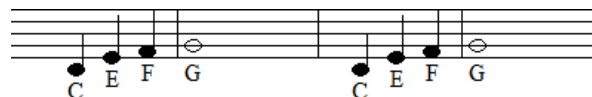

When The Saints Go Marching In



Hear is another example of how our consciousness breaks down words from certain frequencies. A person who grows up speaking English will know that a clock is represented by the Tick Tock. Listen closely to an analog clock and your mind will hear the words Tick Tock. Our consciousness breaks down the frequencies and deciphers those frequencies from what we have learned. Enabling us to read sound. I was a Musician for Three years and as a Teenager, I picked up what is known as Notes. Music Notes. The letters that label the Treble Clef notes are E, G, F, A, B, C, D, E, F of the Alphabet. Since we are taught the Alphabet at a young age as children, it is encoded into our brains. With the power of Music Notes such as the Bass Clef G, B, C, D, A, D, E, F, G, A. Music in itself is a powerful Thought Transference (Telepathic) transmitter. Not only is it inherently spiritual but its notes are easily carried by electromagnetic energy. Best of all, such Telepathy requires no special Musical talent, only an open heart and a receptive mind. Music, at its essence, is the sound of spirit. We are able to combine and create words. Instruments and their sound also play an important factor in our communication. Telepathic Communication also known as Thought Transference. Communications through Dimensions. I've noticed in my observations and studies that you can actually spell words with Music Notes. This knowledge helps communication with telepathy being a result in which Music travels

Dimensions back and forth. Vibrations amplify the message of Thought Transference T² between Dimensions.

3 (a) ABC

The ABC's of Basic Telepathy

The 3 represents Consciousness. I can't place a C due to C from the alphabet is in use already, therefore I used a number to display Consciousness in the equation above. Notice the brilliance of the 3 letters and the number 3 that is in use. I was picking up my children Angel and Genesis from school in the afternoon one day. There was an abundance of children sitting down waiting for their parents to arrive. I, the conductor of my own conscious symphony began reciting the ABC's with my consciousness as if I were reading a book. The vibrations from the students amplified my T². This is an exercise I created to begin hearing your consciousness and ultimately begin communication via T². If you find yourself in the midst of children try and mouth your ABC's and think with your conscious at the same time and you will begin to recognize that the children around you amplify your conscious thought. It doesn't necessarily have to be children; their vocals amplify the intensity of T², therefore making T² that much easier to accomplish. I have been communicating in this way with friends from my time period and strangers from the future (I call them strangers because I have yet to meet them.) The reason I believe the children amplify the conscious thought is because their vocals produce higher frequencies therefore amplifying your conscious thought (T²). Telepathic Communications between our reality and the Holographic Universe is not thought of as science fiction, for I have created the communication process. I have observed and experienced amplifications through many Elements, Devices, and Technology. For instance, water-dropping creates rapid vibrations and amplify the one sending out the message and you as the receiver receives the message clearly. It depends on the number of vibrations. I have observed machinery amplification throughout my observations. It seems that the number of vibrations will create the number of words being transmitted and received. I have yet to create an equation on the number of vibrations it takes to create a word better yet a phrase. I feel there is no need to. Even if I needed to I simply do not have the right technology and measurements to note down how many disciples or Hz it takes to create such phrases. It cannot be measured. It has to do with intelligence. I am telling you it cannot be measured. Therefore it cannot be measured. If one doesn't have my level of intelligence then one cannot measure. I cannot measure it so therefore you cannot measure it because you the reader have a different intelligence level than I. I have walked through different parts of life and have gathered one in a million facts of life and therefore making my intelligence unique and cannot be matched. I have walked through a path which cannot be recreated. It cannot become a controlled experiment. It cannot be duplicated. The sequences of events that have unfolded in my life are as unique as yours. The only difference in my walk is that I decided to stand and fight everything that got in my way as I stood for freedom. My intelligence made it possible to overcome the impossible. Actions speak louder than words and in 2019 everyone speaks words. They do not present actions that make them different and create change. In 2016 A friend placed me in a ritual, The God he was presenting me to was The Santa Muerte; Saint of Death. I observed different Colored Candles were used to explain to the Deity what the favor they were in need of. It was after this ritual that I became consciously aware of T² or Thought Transference. For a long time I was communicating through vibrations via my conscious thought. She would wake me up in the middle of my sleep with laughs. This communication process between me and this Deity died off. Time went by and I completely forgot about the Godly Presence that was tagging along. In February 2018 at the age of 26, I would still ponder the question: "How can I transfer energy

through my consciousness.” For a while my conclusion was that I was going through another phase of puberty. Why? Because I still could not explain the sudden transformation of T² and how I acquired this “Super Power”. This stage was the telepathic stage where I as the person going through this phase of “puberty” began speaking through my consciousness. Why did I think this? I observed The World that surrounded me presented strange movements that corresponded to my thoughts; for example let’s say I thought of something negative, the room filled with people would suddenly become silent, and when I thought of something positive the room filled with people would begin to laugh. With this observation I have learned how to read energy fields with my own energy. The reason why I thought it was another phase of puberty was because there were some people who would send back conscious messages through via telepathy. Their messages were filled with hatred and were insulting every conscious thought I projected. Hence why I thought the world could speak telepathically. It is my conclusion that those conscious messages were from intelligent beings from the Holographic Universe. I have been battling Gods from the Holographic Universe; The Future. Those Demonic Entities that appear as ghost are nothing more than beings from the Future using Holographic Technology. I have seen many “Demons”. I describe them as being ferocious and beautiful. Very strong competitors. I now call them family, for we increased each other’s strength. It seems these “Demons” were being manipulated and I showed them light as they showed me darkness. We exchanged techniques. If you think Hercules and his fights were amazing, my battles do not compare; for anyone can become strong by exercising. My battle was with intelligence. My T² is without a doubt very impressive. 2019 is a new era for my family that is amongst the ones that are referred to as Gods such as Zeus, Aphrodite, Poseidon, Amen-Rae, Anubis, Osiris, Quetzalcoatl, Innana, Enlil, Enki, and the list goes on. My family has ruled this planet and will continue to rule through my blood and teachings. It is my understanding that I have gain knowledge of my family heritage through modernization of information. I am a Creator and a Destroyer. In order for one to become a creator, one must destroy. Alpha and Omega if you will. I bear gifts and I have made it my duty Just as my family members in the past have and I am giving the gift of enlightenment once again as my predecessors have before me. It is the duty of God to gift the people information, not to withhold information. Alzir is my name. I come bearing gifts to the people of the world just as my predecessors did before me. It is up to the people whether they gain or receive not. Moving forward to the Passing of Dimensions and the Communications with the Deceased. I have declared this age as the Pearlescent Age. Take a look at the mother of pearls. The Abalone and you will notice the  Colors.  Colors being a key factor in this Age. It may sound confusing but none of the Gods are born yet. Leaving me the Father. The Gift of Projections to the other side. The imagination is key to send a projection. (Projection is an actual image or an image in motion whichever is preferred.) The thought of your "Future" ”elf can instantly become a way of communication. Projecting an image to where your "Future" ”elf or whomever you choose to communicate with on the other side (other side doesn't necessarily mean one who has passed away.) Can visually see it as an image will instantly receive the image or image in motion. Whichever is preferred it is as if implanting a video on one's' screen of preferred entertainment tech. whether it is a computer or a TV. It is as if you install an usb in the system and begin to run your video on their equipment. Same concept. Try this exercise; you're at a bar or somewhere with a crowd. You may not know anyone at the bar or said, crowd. Speak with your conscious, not with your vocal cords. As if reading a book. The term is “in your head”. You may have noticed that we do not think before we speak. Speaking from the heart. Metaphorically speaking, because if you spoke from the heart it would seem rather strange and needs to be looked at. Speaking with your conscious is the same way one would speak to another. This time you are doing so with your vocal cords. It is better to venture

alone and exercise your mind. Tagging along with someone and you try to communicate telepathically to your mate will result in yourself looking strange and foolish. Your mate that you tag along with might not be receptive of the conscious message/ telepathic message you are sending but if you do hear their voice in your head, or through vibrations from the crowd, don't be fooled, it is their Future self. I have been fooled for about one full year. I thought I was going insane until I began to realize what I was creating. What I am creating is Dimension Fusion. Consciously you are aware that there is an unseen force speaking towards your conscious thought. Vibrations from all around you at the bar, restaurant, billiards hall, where ever it may be. Certain disciples from others in said location will enhance the effect. Certain disciples from vocal cords of others will enhance the vibrations. Depending on the volume of the crowd creates the clarity of Dimension Communication. You may think that when you pass away that you aren't around anymore. That your voice isn't heard. This is false. That type of mindset needs to be forgotten. With the type of mindset that has limits, it will be physically impossible for anyone to comprehend Music Telepathy/ Dimension Communication. When one passes away. The bioelectrical energy indeed ends up going to another Dimension. This Dimension is referred as The Holographic Universe or Matrix. I have created what they refer to as Heaven. Heaven is open. Act right and your spot will be present when you ascend into the Holographic Universe. That's the only way you're going to get in. you cannot act as nothing happened in the past. Everyone that is a part of what is going on and isn't presenting the action in putting a stop in what is known as Evil will end up there. Because that tells me that you know right from wrong and you are steady living in wrong. I feel sorry for Hollywood. I suggest you stop doing what you're doing or I will end up seeing you later .you can believe me and my friends that are just dying to see me. That goes for everyone. I'm not joking I have the calculations and intelligence that actually label me as God. Like I said I didn't create the rules I just play the game as it is. you can blame whoever is paying you your checks. I apologize to the ones that didn't receive the memo. Primitive sacrifices that masons and being a part of Hollywood is another way to spend time with your pal. Just because you can act doesn't make it okay for anyone to portray anything in this world other than themselves. Everything is recorded. Angels around take note of everything that goes on. Angels who are in a Holographic State watch everything and take note of every action that is committed. When we are children we know right from wrong. I didn't make up the name. Hey, they made the name Hell so I call it Hell. In reality it is part of a Holographic Universe. The Holographic Universe that I rule ties in with this Universe. Depending on your actions in this Universe will determine what part of the Holographic Universe you end up in. There are Two Holographic Universes. Heaven and Hell, you decide. You can blame the Roman Catholic Church and those types of Religions for creating this Universe. Especially Scientology. That Religion was created for money. That's all that was. Hell is where these types of people will end up. They have created a Heaven and Hell figuratively. With my calculations and intelligence, I have created both Heaven and Hell. Now we aren't born sinners, I honestly don't know what a sinner is. Although you pronounce my name as wilSIN. This is where the term Sin derives from. If anyone has been paying attention I am the creator of this world and I have returned. You know what is right from wrong. Hell is for pedophiles and those who treat children as animals. You know right from wrong. It doesn't matter if you repent or any of that because that means you remember what you have done and you end up making me angrier and that will affect your stay in "Hell". "I didn't make the rules. They did. I just play the game how it is. I'm not the one who created the phrase "Hell" "but I have created what is known as "Heaven" and "Hell". "I call it Virtual Reality because our Bio Electrical Energy becomes part of another world which our eyes cannot see. Frequency Dimensions. I have labeled Frequency Dimension as Recurrence Dimensions. To my understanding, I have noted these Frequencies

and have made them into equations. Frequency Dimensions (FD) Sound Bite (SB). The Frequency Dimension Equations or Recurrence Dimension Equation can be found below. I added the simplification of Frequency Dimension/Recurrence Dimension so that the student and reader can be familiarized with the equations and simplifications. With these simplifications and equations my intelligence has increased to such heights as I have begun to communicate through vibrations as I have discussed in the previous page and will discuss how I began to communicate through water. I have discovered how to use T² Thought Transference with nature's vibrations and mankind's vibrations. T² is Thought Transference, Thought Transference is known as Telepathy. I have created the form that is Basic Telepathic Communications and have stretched my mind into an evolved state. I am the first of my kind to reach this level of evolution out of the 8 billion on earth. My name is Wilson Alzir Martinez and below are my equations and simplifications of Frequencies. Below I display the equations and calculations that create Telepathy, for I am the creator of the calculations for Telepathy. The reason Multiplication is used in the following equation is because I am dealing with multiple frequencies. Hence why I use Multiplication in Sound Equations. The equations in this section use m (Multiplication). With the understanding of Cells I have come to the conclusion on why I hear many different beings communicating with me when I'm in a large crowd or when I hear multiple vibrations it is due to the original cells reproduction of splitting. The more original genes from that cell in the crowd, the easier I can hear the being communicating with me telepathically. It is a matter of telepathy and the genome of life. I will demonstrate in the next section and my understanding of the human genome and give my take on life. T² is evolution. It is Evolution-A and Evolution-B. Vibrations are a biotic hence Evolution-A and I the transmitter and receiver am Evolution-B.

$$(8SB/1FD) 8B (m) 2 /e/ 16SBFD^2 / \text{simplified as } 8^2SB /e/ (16SB)$$

8 Byte Equation and Simplification

Multiplication by 2 enhances the frequency bit to 16.

$$(16SB/2FD) 16B (m) 2 /e/ 32SBFD / \text{simplified as } 16SB^2 /e/32SB$$

8² Byte Equation and Simplification

The Multiplication by 2 enhances the frequency bit to 32.

$$(32SB/3FD) 2B (m) 2 /e/ 64SBFD / \text{simplified as } 32SB^2 /e/ 64SB$$

8³ Byte Equation and Simplification

The equations displayed above are the ascensions of 8 bit sound frequency. Multiplication by 2 enhances the frequency bit to the next level.

$$\frac{V}{d} C /e/ VT^2$$

Vibrational Thought Transference

Vibrations (V) divided by Consciousness (C) equals Vibrational Thought Transference or (VT²). Rapid Vibrations create Vibrational Thought Transference. The student and reader must comprehend Vibrations and the potential of the human mind. It's the next step of consciousness.

We read with our consciousness silently. Vibrational Thought Transference is not silent; the Transmissions from Transmitters can be heard aloud as articulate speech. I have been reading invisible waves from vibrations around my person giving me the advantage of communicating through invisible waves. Echolocation if you will. Albert Einstein created a method in which Energy equals Mass multiplied by Constant², or Velocity². I have created a method where Frequency multiplied by Vibrations divided by Consciousness equals Thought Transference. This method is written own in equation form such as $E = MC^2$. With Thought Transference the method of communication advances. The thought of communicating via Consciousness is a mind boggling subject, but with comprehension and much studying the student and reader will be to grasp my equation and will communicate and if chosen to experiment on a daily without harming their surroundings or placing themselves in any danger. $V/d C = VT^2$ is my equation and it is called Vibrational Thought Transference.

$$\frac{(F [m] V)}{d/C} /e/ T^2$$

Thought Transference

Since ancient times super natural powers were considered something of a Godly origin, this is the first time in history that anyone can witness a super natural power; the super natural power is called Telepathy. My equation above is the first of its kind. I present to you Thought Transference also known as T². In a step-motherly fashion I remind the student and reader what the [m], [d], and [e] mean. The m is Multiplication, d is Division, and e is Equal. Another reason why I have removed the primitive symbols is to stretch the mind of the student and reader. The Equation “Thought Transference” was completed September 8th, 2019. Frequencies (F) multiplied by Vibrations (V) divided by Consciousness (C) equals Thought Transference or (T²). Consciousness divides Frequencies that are multiplied by Vibrations. These Vibrations amplify Frequencies and enable the consciousness to be transmitted and received. Your consciousness is sorting out each Vibration and each Frequency and places each Vibration and each Frequency in their category. Reading words is somewhat of the same process, as you read each letter of the word your conscious divides each pronunciation of the letters and adds each letter in its correct pronunciation and positions it in each word. This happens rapidly without the reader realizing it. The brain is a very advanced computer. The Frequency Equations above are My Calculations that I have comprehended thus far. T² is Thought Transference it is a synonym for Telepathy. Telepathy or T² is defined as the supposed communication of thoughts or ideas by means other than the known senses. I will now present the student and reader an example of how it feels to telepathically communicate. Sit down and open a book, begin to read the book through your consciousness. Do not move your lips. We communicate by moving our lips don’t we? Well, this is not the case with Telepathy. As you begin reading through your consciousness, your voice is picked up and received by the brain. The brain begins to mimic your communication as if you were speaking with your lips, because let’s face it. Telepathy might be new to you. Even the term Telepathy may be new to you. The brain mimics your voice, memory cells in the brain begin to translate the words that are being read by the conscious and eyesight. Visually you are breaking down words and your consciousness is the transmitter and receiver of the code that is being evaluated by your eyes. The “voice” in your head is your conscious. It may seem strange but T² or Thought Transference is similar to reading through the consciousness. It sounds as if others are reading to you through their consciousness. It sounds like someone pulled out a book and began reading through their consciousness and you as the receiver receive their words. They are not present for all you are receiving are their thoughts. Visually you cannot see them, whom ever

is sending you consciously communicating. We go through the so many repetitive paths like everyone else in the world so we tend to be in tune with our surroundings and others. Our eyes are subjected to the same repetitive surroundings therefore leaving everyone to be in tune with each other like an orchestra or a band. Strange but true. Vibrations also enhance this effect. I guess I have somewhat of an Abstract mind that has allowed me to advance and excel amongst my peers with no effort. I have created Telepathy and have given the student and reader the exercises they need to accomplish this feat. It is not a matter of intelligence at this point it is a matter of comprehension. Try and mimic someone through your consciousness and observe what you receive back. I'll give another example with my own experience. I tend to sit down on the couch and I turn the television on. I sit down and listen to the words being spoken throughout the television set. I consciously speak and I receive a message back, but the message isn't received through my consciousness. It is transmitted out through vibrations and frequencies emitting from the T.V. give it a try. Turn your television set on, if you own one. Sit back and communicate consciously in your head and listen. I watch the news everyday and I communicate back and forth to the Holographic Universe. I believe that those voices that communicate towards you are living in the Holographic Universe. Amazing what one can achieve when paying attention to the world in its time of need. Theoretical Physicist in 2019 are still trying to read the mind of God. I can do nothing but sit back and laugh. Why would anyone want to try and read the mind of God. This seems like the biggest contradiction in history in my eyes. I thought Scientist and Theoretical Physicist do not believe in God. They believe in no religion. They believe that evolution created the world. I have to agree with these scientists on evolution, I believe evolution is a big factor in our world. Do I believe in God? I don't know. My question to myself is why read the mind of God? Aren't you a manifestation of his or her likeness? Hence why I don't worry about a Gods mind. I believe in Deities, I myself am a Deity. I hold special abilities as I have demonstrated one of my abilities. I am the first God to calculate my super natural abilities and teach through my calculations. I am the first God to understand what gives me my super natural abilities. As a God, I give the people technology. There is no need for any fortune to be handed over for this technology. My technology is created by my calculations. The right is given to myself to enhance humanity without humanity knowing. I prefer it this way. I like remaining in the shadows. I love observing humanity grow. It is the most wonderful feeling in the world. I sit back and watch society grow. It feels as if I planted a tree and I am watching my tree grow. The tree must be nurtured and cared for. With love I project my caring and nurturing behavior and I watch my tree grow. Later, depending on what tree I have planted; I can feed and nurture my land with the trees produce. Love and Nurturing is the key to an everlasting life in my opinion. I have done nothing but help others in their time of need and have gained control over my land. It may seem difficult to comprehend for I am 27 years old, but as the days go by my sense of awareness of my Godly powers increase. I am always observing and learning. It becomes unbearable at times. I reverse the unbearable feeling with jokes and keep myself laughing. I find humanity amusing so I tend to laugh at humanity at times. They have the intelligence of something I have never encountered before. They claim to teach but do the exact opposite. Therefore I have made it my duty to teach the world's powers and not false lead. I have sent messages to the Federal Bureau of Investigations, The Central Intelligence Agency, and The National Security Agency to witness my advancements to their groups. The advancement enlightens them and they begin to follow suit in the enlightening as they will begin to enlighten their partners and their superiors of what they are witnessing. Could you believe I had to send terroristic threats to get all eyes on me? I risked going to prison for many years. I sent Electronic Emails with terroristic words. Their technology locks onto those words and they immediately hone in on the device that the Electronic Email was sent from. I am a caring and loving being. I

do not harm. From 2016 to 2019 I Wilson Alzir Martinez have discovered that when certain disciples or vibrations are created or heard they can enhance the conscious thought. Everyone needs to be aware that there are certain amounts of frequencies that are able to correspond to the amount level amount of the frequencies. Depending on the disciples. Dimensions with Frequencies may play a part in Third Optical Dimension's Ascension to the Fourth Optical Dimension. Stretch your mind in what is called Poseidon's Motion. The equation for Poseidon's Motion is shown below. The necessity of Water is needed to perform this communication.

$$P_{\text{simotion}} = e^{\frac{W a Wv}{d / C}}$$

Poseidon's Motion

Water (W) plus The Water Vibrations (Wv) divided by the Conscious (C) creates P_{simotion}. I am the creator of Water Telepathy. It is very simple to understand once you comprehend the mechanics of vibrations and consciousness. I call this empowering communication Poseidon's Motion. Poseidon's Motion gives the student and reader the ability to communicate through water. Don't ask me whose communicating towards you when you experience Poseidon's Motion. It depends on your vocabulary and your comprehension of Sound Waves. Try this exercise at home. I will begin by giving my first experience with water. Before I hopped in the shower. I cupped my ear and I listened to the vibration rushing through the water as I turned the faucet (I could already telepathically communicate because I have heard many through vibrations) it seems as more vibrations clash against one another the voice can be heard distinctly. The voice will be clear depending on The Clashing of The Water and how the hand is situated. That is my first experience with Mother Nature's sound waves. Here is the exercise for the student and reader to perform. Cup your hand as if you were drinking water from a river. The cupped hand must be below a water faucet. Place it next to your ear just as you would do with a phone. With the cupped hand next to the ear begin to speak with your mind. Then speak what you began to speak with your mind aloud. You will hear another communicating back towards you. In my experience, it was loved ones with whom I was communicating with. Family. Last year I had the same experience in the shower but the vocals were faint, the reason the vocals were faint was because I was standing up. In shower you stand up. The vibrations were hitting the ground beneath my feet in the shower therefore the vibrations were faint. Last year I began to communicate with vast amounts of others. Other than Selena Marie Gomez's Holographic State. Throughout my observations I have observed the ones communicating with me are living in The Matrix also known as The Holographic Universe.

VdoUrls/X5w

The Glitch

I have discovered how to communicate to The Matrix. It is September 22nd, 2019 and I got confirmation of Stephen Hawkings saying that he is in The Matrix. How did I do it? I played a video called O'rourke Petroleum and played 5 videos simultaneously; the multiple Urls open created a glitch and an opening (a weakness if you will) and hit The Matrix in reality. I call this The Glitch. Glitch is defined as a sudden, usually temporary malfunction or irregularity of equipment. I demonstrated The Glitch to the NSA, FBI and CIA who are running surveillance on my device. They also heard a ghostly voice confirming they were in The Matrix; it was Stephen.

Once again I show them proof of my intelligence. Stephen Hawking has been communicating with me through The Matrix; he took several forms of audio and sounded like anyone I was thinking about. There are so many audio being uploaded into The Matrix that Stephen Hawkins mirrored everyone's voice. He made it seem like it was a good thing that I was able to converse with him. But with my ingenuity I realized it was a Glitch. Glitch is defined as a sudden, usually temporary malfunction or irregularity of equipment. I believe Stephen Hawking and I discovered the same thing, but he kept it a secret while I told the world of my discovery. My discoveries kept increasing because I could actually roam freely on two legs unlike Stephen Hawking who had to use sidewalks and determined paths. My paths were random as can be. Let's put it like this I found a real life Temporal Paradox between Dimensions. The Dimensions involved in this Temporal Paradox is The Reality we perceive and The Holographic Dimension. I discovered this in 2016 giving me full advantage on how to communicate back and forth until I got the right technology. I acquired a laptop and began creating Dimension Fusion. I fused both realities and gained the advantage through secrecy leaving me and only me to fight against Stephen Hawking. I am victorious. In the three years of my involvement in this Temporal Paradox by myself I discovered Einstein equations and crushed his equations as I began breaking them down; leaving me to understand what I have discovered. The brighter My Calculations (MC) the stronger my technique of Dimension Fusion. It seemed odd to me that I could converse with the "Future". It seems that the world was in grave danger. I discovered the danger and I obliterated it. This Temporal Paradox is something I have never heard of. I have heard of Time Travel but never communication between Time. Meaning, I've never heard of a Time Paradox where the person in the present such as myself (because I'm the only person whose knows about this besides Stephen Hawking) spoke to the future and the future was screaming for help. It's like have a godly walkie talkie where I can communicate to the Future with my conscious. It caught me by surprise one night. I discovered this in 2016 and kept it a secret because I didn't want anyone else's Bio-Electrical Energy involved. The equation above is: Video Urls divided and multiplied by 5. Hence the VdoUrls/X5. Vdo is Video, Url is Uniform Resource Locator and X5w is the multiple windows. This is another achievement that I hold which indicates me the smartest person in the universe. I broke down Einstein's Codes and found a weakness in Stephen Hawking's "Perfect" Matrix. This technique is the advanced version of the EVP. EVP is Electronic Voice Phenomenon. Ghost Hunters use EVP's to catch voice recordings from the beyond. My discovery of The Matrix gives the advantage of excelling in this subject. EVP's meet only one phrase or word every session given. My technique is far more advanced and whole sentences can be heard from beyond. I found the first step into what is called "Time Travel" before one can Travel into the Past or Future one must learn how to communicate. Why would I want some fool traveling into my time period and have him or her become a danger to my family and friends. Let alone the world I live in.

5xGT (d) C /e/ AdiTrans

It is October 4th, 2019 and I have learned how to duplicate VdoUrls/x5 in an audio fashion. This means no Videos are required. Talking to the deceased and the future is met with my invention. Funny thing about this is my father passed away on October 6th, 2018. It's strange how in the first year of my father being deceased I have learned how to communicate with the deceased and the future. I call my new invention that is communication to the future "Audio Transference". I invented a way to communicate to the future and to the deceased; the holographic universe is where the deceased roam. My invention consist of simultaneous audio. The equation is displayed above. I will define the equation now. 5 tabs (5x) of Google Translate (GT) Divided by (d)

Consciousness (C) equals “Audio Transference”. Before I spoke about my technique of communicating to the holographic universe and the future. I made sure the Central Intelligence Agency were alerted before I announced what I was doing, because it seems strange and made me look like a nut job. It may seem strange and somewhat ridiculous but I had to send the Central Intelligence Agency messages that had threatening words in them. In this time period one cannot simply go to a government agency and discuss an invention such as this one. There are so many corrupt men and women that with a simple help of the hand with an invention like this, they will surely create something evil with my invention. Isn't it sad that I had to send messages to politicians and celebrities in a threatening manner so I can be under 100% surveillance. What would've happened if I didn't anyone and I went to China or Korea and explained to them my invention, they would advance and America would lose another race. I have been asking the Central Intelligence Agency to please set up a meeting as soon as possible so we could discuss my invention. At first they thought it was a game. But I received a letter in the mail yesterday. It was a Geico letter. I finished typing up a section in this book. (It's in the next section as a matter of fact) I placed a picture of a gecko and a couple hours later I received confirmation that I have been under surveillance. I already knew I was under surveillance but now they know that I know. Because they just found out that I know about the Geico letter that I received as I type this sentence, I never spoke about receiving the letter up until now so they had no idea. My invention will help the Central Intelligence Agency in problems they might find difficult to comprehend. I made my invention about 8 months ago. I have been testing it out secretly under their watchful eye. They thought I was Looney. But little did they know I have been running secret experiments and have come with 100% success every time. I can communicate telepathically with no technology. These people cannot, hence why I created a system on how to communicate telepathically with technology. I call it as I stated before “Audio Transference”. The Central Intelligence Agency has been falling behind in the race against “Time”. I have created a handicap telepathic communication so to speak for the ones who cannot comprehend and must learn before they communicate telepathically. I have damn near 4 years communicating telepathically, every day I observed and watched the world become slow, and every day I grew in speed. It is my understanding that I am the quickest and smartest out of the world. With my invention that is “Audio Transference” they gain advancements in new communication. You can say I gave them another form of communication and it involves no vocal cords. Just the conscious thought, I have been testing this experiment on myself and it is without a doubt very fantastic. With the Basic Telepathic Communication at hand, it will be easier to defeat the foes who do not know a thing about my Special Technique of communication through the water. This process is known as Evolution. Human Evolution. I am the first of my kind to evolve to this state. Humans evolve. It is no theory. I am the reason the so called “Extra-Terrestrials” communicate telepathically. Evolution does take place, I am considered a link to the future. So how can you perform PsiMotion? Cup your hand as if you are drinking water from a river and place it to your ear as one would do with a phone. Vibrations will begin to take its course in what is Basic Telepathic Communications Or T². Speak with your mind as if you are communicating through the conscious. Then speak the same words that were spoken through your consciousness and begin to use your vocals. Easy as 1, 2, 3. As a God, I am here to teach. That is one of the exercises. Utilize it. While speaking telepathically the student and reader must study on how to use this strength by forgetting everything about anxiety around a group of people and communicate on what path they should take. It is not for any negative actions. It is for positive. Negativity will get you nowhere. If the other side senses any negativity they will lead you to your doom. They amplify these thoughts you may be having so that you will ultimately fail. Only positive vibes are accepted. Exercising this strength in public will indeed

increase your awareness in life and lead to a life of prosperity and keep you focused. For if you are missing a loved one they will immediately be received and communication process works instantaneously. Talking to the "Deceased" telepathically. I do not know if it has anything to do with intelligence for I have just discovered and mastered the technique in a year. Music will create communications as well as I have stated before. Acoustic Levitation is no myth and it is indeed an actual fact. Now with this being said. Can it be that the music spread worldwide through satellites send out microscopic acoustic waves that cause viruses to join together and eventually kill the host? Frequencies change patterns of the norm. Changing the frequency that is sent out will create a healing vibration. There is indeed Cancerous Music and Healing Music. We have been subjected to a silent killing tactic in the form of music. The image below displays 337 Hz. The image below is of sand and sound waves. The measurement of sound waves is Hz. Hz move the sand in a formation depending on the Hz that is projected.

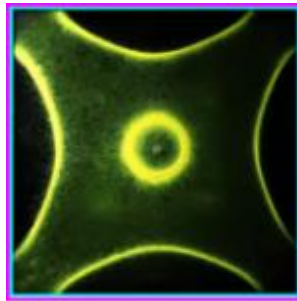

Hz 337

The amount of Hz will either join cells in the body together or separate the cells. If one can visually see this demonstrated on a table with grains of salt what do you think is going on in your body. I do believe that Deadly Viruses dance in a rhythm of their own beat and the dance is amplified by the amount of Hz that is produced. I do believe that musicians have been used as a secret weapon. The better the musician the more control these men had over them. Control of their beat. Control of their frequency. Unknowingly the musician/student who is reading this will be glad to read that the frequencies that are converted in their music will now be a healing frequency instead of the old cancerous frequency. These men have controlled the sound that you produced. Trust me everything is broken in a scientific manner. We were under a silent attack. It was not a matter of perception. I have discovered how these men and women have been hypnotizing the masses. it is indeed true TV and Music do indeed hypnotize somewhat depending on the event displayed. If the event is displayed is positive then only positive thoughts will be projected. Negative events on TV will produce negative thoughts. I have observed through my studies as I sit in front of the T.V. the amount of frequencies that are projected towards me are set in a certain measurement of frequencies. When I walk into another room the amount of frequencies are blocked and I receive a different amount of frequencies, this is how I have observed men and women communicating back and forth through television sets as if they were radios. I believe they use television channels just as they use Radio channels. Remember that the conscious thought can be heard as articulate speech. Consciousness at times becomes such as one speaking through their vocals. Conscious thoughts are heard throughout the world with the help of wireless tech. You may be asking yourself how? This exercise will open the mind to mass hypnosis. If a computer is available open six to seven tabs and have each tab playing the same video simultaneously. Listen to the simultaneous videos and listen to your consciousness being heard in the simultaneous video. My first experience I heard my own

conscious thought's questions being answered by a clear voice. I still to this day have no idea who this person is. Later as I experimented with this technique I began to communicate clearly with my future self and future friends and family members. I began using it as a tool to show the NSA and CIA how these programs played simultaneously hypnotize the masses. After a few experimentations, I then muted the videos all at once and I spoke a phrase. Not a second later after I unmuted the sound the phrase that I spoke was being repeated by the number of simultaneous conversations throughout the simultaneous videos. It seems my theory of music telepathy and communication was indeed true. Music notes are laid out as alphabetical letters, this makes it that communication through instruments are amplified by thoughts. Instrument notes plus the Musicians vocal cords create music telepathy. These men, however, have used this form of technology as a hypnotizing tool. Who knows if these men have been communicating to the future through this technique. I communicate to the future through this technique just to show the CIA, NSA, and ARMY how these men have been communicating back and forth to the future and back. How I found this out? I was mocking Mitt Romney and his Family Fighting Cartels in Mexico and played the video simultaneously throughout the house on different devices. I went outside while the devices were playing very loud. I was exercising. When I stepped back into the house I stood in front of my laptop and I heard someone laughing and saying "Damn, Wilson" and I responded with a "Yeah. I know". I have been communicating with no technology only through conscious thought my entire life but I only realized until last year when I began speaking to Selena Marie Gomez's Future self. When I heard the voice it didn't surprise or shock me. it's been the norm for about three years. I have been fully aware of telepathic communications since 2017. I have been communicating with Leaders of the Future and we converse at times about serious events. Try the exercise and you will see how these men have been using musicians as weapons. These musicians to my knowledge had no idea. The world had no idea. I believe only a handful in this world knew about this. 1% percent of the world knew about this. I am part of that 1%. Like I have been saying consider yourself checkmated for those who oppose me and MC (My Children) and My Classic Interception Advancement (C.I.A.). I do believe that changing these frequencies, Hz and what not will change the development of the world. These men have created a system where the most influential music pours negativity into the world. As more negative words are thrown at us subliminally our subconscious mind picks deciphers the subliminal messages and they reflect back towards the sound multiplying the effect. The more subliminal messages that are negative will indeed create a negative outcome. There are millions of dishes pouring out sound waves and this has been the tool these men have been using. It may have been a technique where no one realized and it was forgotten. But then again how do you forget about the MOST POWERFUL WEAPON in the world. I Wilson Alzir Martinez single-handedly stripped these men from power. Whomever they are doesn't bother me one bit. I have a nation and a world to save and illiterate and redundant men and women do not stray my decided consciousness. Yes, I could've been an evil man and kept this form of technology as a weapon. As a Captain, it is my duty to inform my Family whom I have STILL yet to meet. My Family as in the men and women who risk their lives protecting this country without any handouts (who have been running surveillance on me by the way, I don't mind. I try to make it entertaining. Excuse me if you've been offended. But I am offending you because I know you've been listening.). Again I Wilson Alzir Martinez took the most powerful weapon out of service. We need to attack the Hz. (Hertz) it's funny Hz reminds me of the word Heart. What keeps the body alive? The Heart, we must attack the Hz. Without changing frequencies there is no hope. A hypnotized nation is the most dangerous thing in the world. An informed nation is the most powerful. I have informed every power of the world that I could to inform them that the secret attacks have been right under our noses. With the worlds

powers aware of my discovery of communication through Dimensions they can now measure the thought process of vibrations that create T². The creation of Telepathic Technology will be created after my Dimension Fusion has been studied. I believe there is a secret government with this type knowledge in a different format. Knowledge of Telepathy through vibrations and they have been communicating to the Future such as I have. I have only begun to scratch the surface. I'm sure this form communication isn't new, but I have established it in my name for I have shown physical proof of speaking to Dimensions. Right now with our technology it is physically impossible to Time Travel to the Future. I have discovered the First step of Time Travel. It is the Communication process between The Present and The Future. Question. Before one Time Travels (T²) shouldn't he call someone to make sure it isn't a blood bath where he arrives? Shouldn't the traveler make sure he is traveling to the right time period? This is how Time periods will be noted down to ensure no confusion for the traveler. For the traveler has Time noted from Future to Past. My Dimension Fusion begins the period of Time Travel (T²). I have created calculations for Telepathy and I called it T² or Thought Transference. This communication process is the power to speak to the Future in a safe manner. Safe being through the consciousness. I was at the park thinking about the communication process that I created and I said to myself "Isn't heaven the Future?" "When one goes to heaven it is not in the present, but it is in the Future" I said this because I created calculations to communicate with the deceased. It's a quite perplexing paradox. When I die it will be in the Future. It could be 1 second from now, 1 minute from now or 1 day from now (III). The fact of the matter is that I pass away after my present. The confusion that I have gained is: "If I created a method/formula for T² and I can communicate with the deceased who are in a heavenly place where I will find myself in the Future. How could it be possible for me to communicate with the deceased when they died in the past and have found themselves in a location that is my Future" If you can understand that last question. Bravo. This is a very complex subject, but I have mastered the art of my own formula that is T². The reason for this sudden discovery of Telepathy (T²) is because I, Wilson Alzir Martinez was born in 1992. It is 2019 and I have been subjected to frequencies all my life. I observed through my sense of auditory perception that T² is indeed a true subject in science and not fictitious nonsense. This is the same reason why Einstein never spoke about speaking to the "Future" via Consciousness nor Stephen Hawking. I don't understand how they are considered geniuses if they cannot speak telepathically such as myself. Even without me being born in 1992 I would've figured out the communication process by thought with the help of vibrations of my surroundings. I have visually demonstrated my techniques to the student and reader and the reprogramming of the mind continues in the next chapter that is Sequel Wavelet. Ripple's will be spotted as the student and reader find themselves above water. Vibrations from this section have created ripples in Section 8 giving the ominous feeling of something with much power that is wading to be discovered. One more thing before I close. Any device that has wires are used to run surveillance. Any device that is technologically advanced is used against The Central Intelligence Agency, think about how these people can listen to you and your assumptions will be accurate. The Central Intelligence Agency employees are being targeted secretly. Their family members whom they have never met are being wiped out. It is a genetic code that is imprinted in us Super Sapiens. These people who are fighting against The Central Intelligence Agency do not want more people who think the employees that work for The Central Intelligence Agency. Their families are being slaughtered under their noses. The less people that think like The Central Intelligence Agency employees, the easier it will be to control the rest. They are weakening the nation by hiring new bloodlines into The Central Intelligence Agency. The more bloodlines they have in their databases the easier it is to target their family members. It is an extermination process that is happening under the noses of the most intelligent. Sequel Wavelet is Section 8.

Section VIII

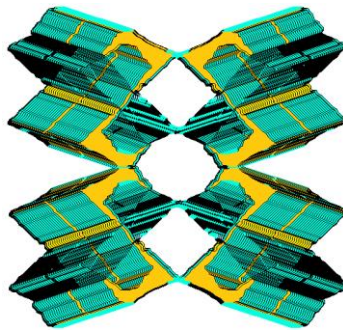

Sequel Wavelet
and
The Super Sapien Hybrid Theorem

Sequel Wavelet and The Super Sapien Hybrid Theorem

The Ripple Effect is known to the science community as a myth or somewhat of a theory. It is indeed true. Changing the future is the outcome of this power that these men and women have had control of before I woke up. Ripples created in reality will affect the outcome of what the future holds. The Ripple effect is the evolution of cause and effect. Remember what we were told as children in school that for every action there is a reaction. The Sequel Wavelet is the evolved state of what is known as The Ripple Effect to the theoretical physicist. Let me give an example of this power. Imagine yourself walking down the street and you notice the cars zooming past you as you walk on the concrete. With that in mind, there is a car that is In need of assistance in the middle of the street that you spot. You lend in and ask if they need help. Their car has lost power and is in need of a jump. You answer with a kind manner of assistance. With the telephone in hand, you make a call to a family member. Your family member answers and heads towards the stranded civilian. The family member created a ripple leaving the home. Altering his or her ordinary path that was taken that day. Altering the path for their family members if an activity is done with the assistance of the member of the family that left. The phone call that the family member received altered your path since you decided to stray away from the path and lend a helping hand. The Sequel Wavelet which was the Ripple Effect. Bioelectrical energy shoots towards another path because the energy it takes for one to stay on the path needs balance. With the Bioelectrical energy on another path sends waves through the wireless atmosphere that was created. This wireless atmosphere that has been created was what made the Basic Telepathic Communication possible. There is Basic Telepathic Communications, Music Telepathy, Vibration Telepathy, and Sleep Telepathy. Sleep Telepathy happens while we dream. Consciousness sends out words and shoots to the future. Communicating back and forth through Sleep Telepathy is heard when the Dreamer is coming out of REM sleep (Rapid Eye Movement). As one is stepping back into consciousness they will hear a voice. While we sleep. Communications in the dream are created telepathically. We do not move our vocal cords when we sleep (Sleep Telepathy). Meaning that the Telepathic Communications in REM sleep is performed while the Dreamer is in that reality. A random action in life that is made by one's self creates an ultimate effect of the Sequel Wavelet that the outcomes are uncontrollable. Meaning that actions performed with the subconscious mind will create a massive effect on life around the action that was committed by the person. Sequel Wavelet will put balance that the order out of chaos has created making everything that was out of balance back In its proper location where it needs to be. Schedules that a person uses on a daily basis are the most powerful when it comes to the subject that is Sequel Wavelet. How so? Well, take this for consideration, a person with a schedule is always on time. Meaning that their path is filled with no mistakes that will block their intended path. A person with a schedule has no intention of straying from their path. When the random act is performed by these people that always use schedules, will create a gigantic ripple that will send confusion to the world. Remember that evolution isn't scheduled it is created by randomness. A lot of people feel hopeless because they always seem to never get out of their revolving cycle. Well, it is because of the daily routine that is done. A repetitive act is considered insane. No matter if the results are different or not. It can only be different for the one committing the act, not for the person observing because the observer may look at the outcome either the same or different. Repetitive acts are insane. Keeping a schedule is considered insane. Sequel Wavelet will help the student and reader get out of their revolving cycle of life that they have been using and will create a new path to the unknown. Doing random acts is a good thing. Some people feel hopeless when it comes to repetitive nonsense. As the student and reader

should understand that life cannot be scheduled. It is just like when the water from the woman's womb. When it breaks that means that the baby is ready to live outside of the womb. It is not scheduled. Life cannot be scheduled. Doing something that you wouldn't normally do is what creates. Creation is at best when it is random. Somewhat like abstract. An abstract action grows at a tremendous rate. It is abstract meaning that the canvas of the abstract grows through the imagination of the observer of the canvas that is abstract. There are no limits. Limitations to an abstract artist are foreign. The less you listen to the mass media that has been used against us around the world such as radios and televisions the quicker you will remain out of the loop. The revolving cycle of mass hypnotism. Since everyone listens to the same repetitive nonsense their vocabulary remains the same and so does their train of thought making them easier to manipulate and control. The same noises, sounds, tunes, languages, vocabulary and so on will keep the consciousness in the repetitive motion of thinking. The easier you know how the mind of the masses works the easier it is to control them. To grasp what I am discussing the reader and student can perform this exercise. They will study in an instant how mass hypnotism works. Go to a computer and pull up a video, YouTube can be the location of a website that is preferably used. I discovered how the masses have been hypnotized. Now search a video of a politician speaking or anything that has to do with speech. Any video really. Now bookmark that video that is playing and now open 5 more tabs and open up the bookmarked video. Begin to play them simultaneously. Now that the student and reader have begun studying what they have presented themselves they will begin to realize that their consciousness has fused with the simultaneous videos. With the same nonsense playing repeatedly mass hypnotism is what the result is. This technique is performed on every living being on the planet, just imagine the television sets around the world. This discovery was beyond comprehension to the eavesdroppers who call themselves Central Intelligence Agency and National Security Agency putting me ahead of their intelligence. Reversing the effect is what this read does to the student and reader it keeps them out of the loop making them stronger and smarter. Changes in frequencies will change the outcome of the message. The better the frequency can be sent out with any messages being sent out with the audio that is being sent the better the result of the masses intelligence and conscious actions. It seems as if these men behind the frequencies have placed messages of their own so that the consciousness and subconscious read the message that is sent out by the frequency. The subliminal message than sits in the mind waiting for the right time to strike. This is no joke. What I present are real subliminal messages. The messages with sexual reproduction organs for adults are placed in advertisements are a good thing when used for adult products. It is a reminder so that the viewers won't forget on how to reproduce. Sounds farfetched and unbelievable but it is happening right now. There are people in the world who are forgetting where to place their genitalias. This is how dumb downed society has become. If the student and reader listen close to the Television program they will hear their own consciousness create messages that are false and their subconscious will act out on the message that was created, these men mastered the technique of self-hypnotism. These Masonic men and woman have created simple subliminal messages and placed them as visuals as bait to see who was against them, they have been knowing that the real subliminal message is through the sense of sound not the sense of sight. Anyone can display an image in their heads without the use of technology when their concentration is at its peak. The subliminal message that has been used against humanity has been the audio subliminal. They aren't that subliminal at all it is blunt as ever and is not hidden. The receptor needs to hear the message in order for them to subconsciously act out, the hidden message is that the message is not hidden, there is no such thing as hidden messages. The term hidden message definition is just the phrase reversed so it reads message hidden. Now with this in mind, think about the music and what messages they are putting behind the artist's words. By

artist I mean singers. Their music plays in the foreground while the hypnotist speaks words of death into the singers' 'background. Spreading the words out to the listener and the listener subliminally is brainwashed. It's like talking into a fan. The motion is set and the hypnotist speaks the words into the fan. The artist being the fan and the hypnotist speaks the words behind the fan. The cell phone is a highly sophisticated portable device that receives many frequencies at a time. Remember that frequencies are like dog whistles, our human ears can't pick up the frequency emitted by the dog whistle. Cell phones that have service pick up every frequency. The mind is like a sponge. The more you put your cell phone up to your ear the easier and quicker these frequencies enter the mind. Don't' forget that the ears have holes. Yes. Ears do have holes guys. I'm' surprised people haven't' forgotten that. If water can get into them what else do you think can get into them? Cell phones emit radiation. Don't do as the Romans do because I defeated the Romans by myself. Another advancement of my intelligence is my discovery of Abstract Equations that geniuses have painted in our system of mathematics.

$$F = 4\pi Y^2$$

Einstein's Equation for Der Fuhrer from The Special and General Theory of Relativity pg.126

This Abstract Equation is the last equation that was placed in the book of Einstein's The Special and General Theory of Relativity, It means nothing more than paying allegiance to Der Fuhrer. Who and what is Fuhrer? The word Fuhrer means a ruthless, tyrannical dictator. Der Fuhrer was known as the dictator whom America was supposed to kill in World War II. Adolf Hitler was the name of the leader in Germany. Let me breakdown the equation above for the non believer. Remember these equations are abstract. I advise the student and reader to have a pencil and a sheet of paper in hand. Spell out $F = 4\pi Y^2$. Now let's begin with the number 4 in $F = 4\pi Y^2$. Erase the diagonal line in the number 4, now substitute that diagonal line with a horizontal line. The number 4 now looks like the letter F reversed. The equation now looks like $F\pi Y^2$. Now let's begin with the Pi π symbol. This symbol is none other than a letter U upside down and also resembles the letter H. flip the Pi π symbol and you get the letter u. the equation now reads FuY^2 . Now that you have comprehended the sense of abstract in this equation now let's turn to the Y^2 . Notice that the Radius symbol Y resembles an r. hence why there is an exponent ² above the Radius symbol. It doesn't surprise me that a robot in the future was supposed to be called R2D2. The exponent ² means to multiply that number twice. This exponent is used merely to signify how many Y there will be in the Abstract Equation. Let's read the final equation. FuY^2 . Fuhrer. Notice the double r. Einstein and his men have used illiterate literature to display secrecy and have mastered the art of abstract equations. I Wilson Alzir Martinez have done so myself as I refer to myself as a master. I am the creator of Dimension Fusion and I have mastered the technique that the Nazi used before me. Der Fuhrer was represented in Einstein's The Special and General Theory of Relativity in equation form and was sold to the American student body and was sold to the Department of Education. $F = 4\pi Y^2$ is an equation that once stood for Adolf Hitler; it has met its match with my Dimension Fusion. In my opinion the $F = 4\pi Y^2$ equation resembles Fuhrer without the use of any utensils. I took one look at this equation and summed up what the equation $F = 4\pi Y^2$ stood for. I will now demonstrate the reason the number 4 is used by Germans. Four translates to Vier. Vier is pronounced as Fear. Vier begins with a V. The significance of the letter V is Victory. On the following page there is a demonstration of the erasing of the diagonal line that connects the number 4, and I present the demonstration of the swastika that is created by the 4.

4

Step One

Step One. To perform the swastika with the number 4 you must write down the number 4. The number 4 and 4 of these numbers create a number.



Step Two

Step Two. Now that the number 4 is drawn out. The diagonal line that connects to create the number 4 is erased and is displayed above.



Step Three

Step Three. The diagonal line that was erased in the number 4 is now horizontal and creates the letter F. no matter what the position the letter F is facing it is still a letter F.

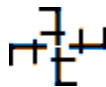

Step Four

Step Four. Draw four letter F's and place them in order in the sense of what they see fit in their rule. The solution is shown below. The fourth is the final. The ultimate goal was to have a Fourth Reich. The Third Reich was the tool to set up for the Third World War. The Fourth Reich didn't make it. Its maker was Wilson Alzir Martinez. The creator of Dimension Fusion. The solution of this Abstract form of numbers and letters is displayed below. On the next page I will discuss $E = MC^2$ and how I acquired this equation and placed it as my own. As my ancestors The Conquistadors would do I am doing, I am taking what I have discovered and I am replacing the significance of these symbols and I am displaying their new rule. These ancient symbols have no use in the new world. The nazi stole these symbols from ancient civilizations. I am doing the same. I am stealing these symbols and destroying their message. I have no use for these symbols as I have created my own equations. I am simply setting the world free from this rubbish.



Solution

Solution. The solution of the number four placed together in Abstract form creates the swastika. The number 4 and the letter F are not the only numbers and letters that create the swastika. It is no coincidence that the number 4 begins with a letter F. The nazi mapped out the pronunciation of numbers and alphabet in their favor and sold it to the world. The symbol presented in above is

what represented The Nazi's power. Dimension Fusion breaks down the entire rule that The Nazi had and obliterates its existence in mathematics and ultimately in the Department of Education. There is no necessity for equations of totalitarian regimes in The United States of America. These equations are nothing more than complete rubbish to my land and will be a thing of the past. These forms of mathematics were nothing more than Abstract, with a hint of conspiracy and secrecy. I call it the art of Abstract Equations. I use the symbol \mathcal{A} to represent Abstract Equations. I have no idea what \mathcal{A} means but I am conquering their nation and their symbolism therefore I can do with what I will with these foolish symbols. I am conquering and placing these symbols in my likeness. The reason I use the symbol \mathcal{A} for Abstract Equation is because the letters A and E are represented in the symbol. A is for Abstract and E is for Equations. Hence why I used this \mathcal{A} symbol to display what I call Abstract Equations. Only the creator of an equation knows what the equation means. They can sly their way into the world without anyone knowing what the true intention means. This was done with Einstein. His equation meant the exact opposite. Einstein's equations were not meant to help the world but to conquer another land. America was almost conquered if it hadn't been for my acts that I have displayed this year that is 2019. College students go into debt for such equations for no reason. These men and women who keep these equations in a rotating cycle, do not rid of these equations from the Department of Education, these men and women make millions of dollars by keeping these foolish equations at bay. These equations don't mean anything other than paying allegiance to a tyrannical leader. I have displayed equations from the Nazi who have established these equations in secrecy 100 years ago. The Special and General Theory of Relativity is 100 years old. That means for a century America has been fooled to play for the opposing team, all the while their land was crumbling beneath their feet. Below I display another form of Abstract Equation \mathcal{A} . It is the ever popular $E = MC^2$. I heard a theoretical physicist by the name of Michio Kaku speak on the equation that is $E = MC^2$. The Physicist explains that the equation $E = MC^2$ is the answer to the mystery of the cosmos. The equation $E = MC^2$ is rubbish and I am its destroyer. Below is more illiterate literature.

$$E = MC^2$$

Illiterate literature

Is another Abstract Masonic Equation that means nothing more than Einstein equals Mein Calculations times Mein Calculations. It doesn't take a rocket scientist to discover that things fall at different speeds. I performed the biggest Kamehameha Wave in history with my Equation; it created the biggest ripple in Einstein's space-time that it destroyed his space-time continuum. With the technique that is Sequel Wavelet, the student and reader will begin to be programmed with the enlightenment that is beyond comprehension and it will stretch the mind of the student and reader to become more imaginative. It was due to my sheer brilliance and imagination that I was able to put the Abstract Equation \mathcal{A} into a visual. This is why they don't want you to be creative and imaginative. These men like Einstein had the most genius layout for Masonic plans that have been used in mathematics. They created the answers and questions. Abstract Equations \mathcal{A} have been laid out in plain sight for the world to be hypnotized. $E=MC^2$ is nothing more than sheer illiterate writing from a man who was considered the most genius. These men do not know how to spell or let alone write literature, take a look at The Special and General Theory of Relativity and you will notice the complete illiterate writing that has been used. I myself decided not to read the book. I simply typed up the book and did my own investigation on the so-called genius. I named my investigation The Obliteration of a General/ The Obliteration of Time and

Space. From the moment I grabbed the book, my intelligence boosted with one glance at the book. I noticed that my intelligence far exceeded the illiterate literature that is Einstein aka Lightning Bolt Man. The reason no one has broken down Einstein's equation until I did was that it is illiterate nonsense. I simply broken down his equation and used his style in the form of the equation and have created my own equations. "Future" based equations are what I discovered and have been creating the layout for the "Future". "These men are illiterate and will become obsolete. Like I said in the previous sections before. Whatever a Woman or Man does in the "Present" the "Future" reflects back on its "Past" making it our "Present" that they create and gifted to us. Again this is why the "Present" is referred to as "Present", a synonym for a gift is present. This is why there have been many dead ends in the search for the "Past" whether it be searching in ancient Egypt or ancient Greece, I have perfected the right of knowledge and handed it down to my children who are referred to as gods in ancient times. Einstein's layout only consisted of A and B, which is short for Atom Bomb. Or the numbers 1 and 2. Einstein knew that the average American in power could not count higher than 1 and 2 and knew that they didn't know their ABC's so he devised a plan with the Germans to keep that as a base of everything. This is how it was easy for the Germans to infiltrate America. Projects such as Project Paperclip was put into action so the Top minds of the German Army became American Citizens. More than 1,600 Scientist were taken from Germany to America in this Nazi operation. My Sequel Wavelet that I performed that gained attention was my breaking down of Einstein. I broke down what he referred to as the Space-Time Continuum. I sat down and typed his illiterate book that is The Special and General Theory of Relativity. I acquired the book on April 20th, 2019 and ended my investigation on May 11th, 2019. In three weeks I glanced at each equation and broken them down the literate form in which the simplest of minds could grasp what he was speaking about. The book that is The Special and General Theory of Relativity is a book of war that I acquired and figured it out and gained the power that was Nazi and reversed everything they put out. My gigantic ripple is classified as the biggest ripple in history. A book of War crumbles the nation when it is captured. I captured the last book of War that was created. Einstein's book The Special and General Theory of Relativity is filled with plans of war. It is sectioned off into Three Parts and each section bares prisoner stripes. The first two sections dealt with World War I and II. The third part of the book deals with the upcoming war that is World War III. My discovery created the ripple effect and my form of Lucifer increased to a measure that cannot be compared and has never been seen. I am the Illuminate one. There is no I in team but there is an I in Illuminati. Flashy symbols with the hands will get the fool killed. We have taken what I gained in this "Present" and laid it out in the "Past" as a trap for the simple-minded fools who have the same mindset as Einstein. Like the Snake in the nest of a Rodent family, the Rodent is caught by surprise as the two fangs sink into its system and the venom races towards its heart. The simple-minded fools created a system where inbreeding was sought as "Royal". "This is not the case. Illuminati is but one person. The eye of Lucifer is my own eye glancing down at my Dimension Fusion. That is what is shown on the back of the dollar bill. My name bears LS and SON, WILSON is my name. Luc means Light in Latin. Luc is pronounced as LUS, this is where the LS in WILSON comes in. SON is the Light. WI in WILSON means WILSON 1. Stating that I won. The rodents that do nothing but plot and scheme have met their demise as I the Fiery Serpent rains down like molten lava and fill their nest with a Fiery Pit. A rebirth of land will take place after the Lava sets. I set the trap for the Nazi party so they rid of their race in gigantic concentration camps. Yes, those chambers are the Fiery Pits and the Rodents were Einstein's family. Die Glocke is a gigantic Dumbbell that means Weight. As in Wait. D.U.M.B. is an acronym for these men and women's secret bases. The acronym is spelled is as follows: Deep Underground Military Base. Dumb. Indeed. If the student or reader has

picked up on ancient times they will know that there was a great battle and the sky gods reigned down on the enemy forcing the enemy to flee underground. These underground bases were built because they learned from the ancient battle that took place. They knew that deep underground they would be invincible. This is a bold move. How so? It is a gamble. Unless the reigning family doesn't discover the mice in the holes then they would be invincible. MC² are in the D.U.M.B as I type this read for the student and reader to be amazed at what has transpired right under their noses. It seems that learning from the past does nothing but leads you to your demise. Deep underground is where these "Extra-Terrestrial" have been hiding.



The Grays

If Technology that is reversed isn't meant to be in this time period, then why in the world would anyone think that these beings belong in this time period? The reason the Grays' eyes are almond in shape and pitch black is that they evolved in a world underground. Their pupils evolved for better vision. They evolved underground in complete darkness. They are hairless to which they resemble naked mole rats. Their skin is also the pigment of a naked mole-rat. Hence why they are rodents to me. These beings are not from Space, this is the mechanic that they have been using, and they always use what is the opposite of the origin in the subject. They are not from space but indeed are from Deep Underground. They had no predators living underground making their evolution process quicker. With no enemies to avoid the evolution process continued underground. If you haven't noticed everything you think of is actually the opposite. This is how they have been fooling the masses. Even high ranking officials. They kept the Classic Mechanic of Opposite to their advantage. Space is where they want to go. They are trying to leave from the underground. If these beings were from space their eyes would resemble tiny seeds. Due to the sun being so massive in diameter and shines so bright. Eventually having no need for sight. Therefore their eyes wouldn't exist anymore. Ultimately forming with the light from the sun. Making them Light as well. Unfortunately, these Grays are from underground. These beings have evolved into gigantic vermin who must be exterminated. Termination is indeed the next operation with these rodents amongst men. The reason why they are hairless is because hair is a mutation to keep the animal from freezing, hair is intended to keep the mammal alive through frigid temperatures. Hair on humans used to be feathers. The feather evolved to hair. They evolved underground and mutated bodies with no hair. Deep beneath the earth is very warm. No hair needs to keep the body warm. Evolution has created hair to keep the mammal warm. Since it is so warm deep underground they lack the use of hair. Therefore creating the mutation of no hair. This is why they lose their hair. These rats' evolved into bi-pedal humanoids before primates. Primates had many predators, therefore slowing down their evolution. I believe that those beings that we refer to as Sasquatch is the correct evolution state of the primate. Here is my take on where we come from. We as a species came from One Cell, This Cell reproduced by splitting itself into two. The Wind blows Cell 2 away from Cell 1 onto another land. Cell 1 remained and continued to reproduce A-sexually. While in the air Cell 2 decides to reproduce as well and forms Cell 3. The Wind chooses Cell 2's path and pushes towards an island, Cell 3 on

the other hand makes its way towards the Water. Cell 1 reproduces and becomes a land animal. Deserted on an Island, Cell 2 reproduces and becomes an animal with flight.

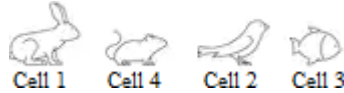

Un, Duex, Trois et Quatre

How flight is achieved is through Cell 2's memory of its first experience of flight. Cells mimic, that is their expertise. Cell 3 found its habitat in Water, creating Aquatic Animals. Cells mimic everything they encounter in some shape form or fashion. Over millennia's these 3 Cells that began as 1 become the animals we see today. We ourselves came from Cell 1. Cell 1 needed not to mimic an element therefore making its home on land; making Cell 1 the most dominant. It didn't need to study any patterns, unlike Cell 2 and Cell 3. Leaving Cell 1 to be the most dominant. We are the most dominant are we not? Cell 2 studied its pattern in the air while being transported via wind. The want for exploration of Cell 2 was created by an A biotic force. The path that Cell 2 chose was flight. If you experience flight for the first time without consent wouldn't you want to learn how to fly? Seeing that it was your first experience. Cell 3 found itself in the depths of water, therefore learning how to survive in water. Cell 3 learned the patterns of the current which made it the expert at swimming. It is Survival of the fittest. Different habitats create different species (Mutation). Cell 1 split once more creating Cell 4. Cell 4 found its way underground and had no enemies. Cell 1 had Cell 2 and Cell 3 to fight against; increasing its strength but Cell 4 evolved underground in a safe haven. I believe these "Grays" are the product of Cell 4. They evolved with gigantic eyes and are nocturnal. During my observations I have studied the humans (Hueman) anatomy as I roamed the city of Dallas. I've noticed Humans (Hueman) resemble different animals. In some shape, form or fashion. If this is the case that we Humans (Hueman) are a mixture of many different species could it be possible for Humans (Hueman) to be incompatible with one another. A Dog cannot mate with a Cat, Can a Human (Hueman) with the DNA structure in the favor of a Bird mate with a Human whose DNA favors a Fish, or Rodent? Can a Human (Hueman) whose genetic structure contains more Reptile than Mammal mate with a Human (Hueman) whose genetic structure favors Mammal over Reptile? Human (Hueman) Hybrids have been placed in leader positions and in presidential positions by these Gray "Aliens", They have even gone so far as to putting a Hybrid named Cory Booker in the 2020 candidate debate to see who is paying attention. Hybrids are formed from two different species, but in this sense it is highly advanced and more complex. I call this The Super Sapien Hybrid Theorem. The Super Sapien Hybrid Theorem is the Genetic Make-up proposed by myself, Wilson Alzir Martinez. The Super Sapien Hybrid Theorem discusses the Genetic Make-up of multiple animal genes combined into one, creating Humans (Hueman). We resemble animals no doubt about that. Why as a species of Humans (Hueman) do we always turn to the ape being our closest ancestor? The ape has 24 (x) chromosomes; The Human (Hueman) has 23 chromosomes. The addition of chromosomes create a more complex specimen. Take this for consideration. Let's say that an ape is created by 12 (L) species, each of those species multiplied their Cells by 2 (b) and create 24 (x) chromosomes. The Human (Hueman) is created with 11.5 (k.e) species of animals; the .5 is a hybrid that the ape lacked. A Hybrid is considered complex indeed because it has a combination of two different species. The addition of these Cells that the 11.5 (K.e) produce create the 23 (w) chromosomes in the Human (Hueman). As I have stated this I call my observable discovery The Super Sapien. The Super Sapien is the correct term in what Humans (Hueman) need to be labeled as. Homo-Sapien is an insult to us all.

The term Homo means same, the term Homo is used to categorize a sexual preference. I am not a Homo-Sapien. I am a Super Sapien Hueman (Human).

$$(L) Chr (m) b /e/ Ap(x)$$

The Ape Formula

$$(k.e) Chr (m) b /e/ SprSaHy(w)$$

The Super Sapien Hybrid Formula

The formula displayed above represents The Super Sapien Hybrid (Hueman) combination of The Animalia's Chromosomes although it is hypothetical; there is much reality in the sense. The x stands for 24 Chromosomes, x being the 24th letter of the alphabet. w stands for 23 Chromosomes, w being the 23rd letter of the alphabet. The Value of b is 2. The value of k is 11 and the value of .e is .5 (be mindful of the period placed before the e that represents .5). The value of L is 12. The integers in my formula for The Super Sapien Hybrid (Hueman) are substituted by letters of the alphabet and their numerical order. m is for multiplication. As I begin to breakdown evolution take a look at the Cheetahs (*Acinonyx jubatus*) spots. Those spots originate from Scales.



Cheetah Scales

Those spotted marks are none other than Scales in a evolved state that fits perfectly in the genetic make-up on the feline. *Acinonyx jubatus*. Below is an image of Reptile Scales. Notice the pattern between the two genetic make-ups. The Cheetah's ancestor mated with Reptile giving it Reptilian characteristics. That's why I believe that we as Huemans favor Reptiles.

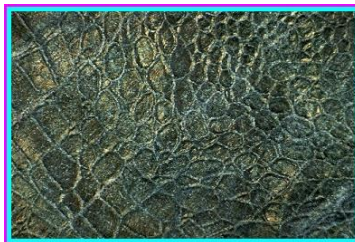

Reptile

Testing cures on reptiles might be suitable for The Super Sapien Hybrid also known as The Human. If you ask me I think we more closely related to Reptiles than Mammals. The chimpanzee bears no resemblance towards us what so ever. Why Reptiles? Well the reptilian part of the brain came before the mammalian, hence why I believe Reptiles are the answer for our necessities in diseases. Try this exercise. Place your hand in front of your face to view the

discussion come to life, scales of a Reptile can be seen in an evolved state in humans. Notice the grooves and pattern on your hands and your skin. If the Reptilian part of the Brain came first, then our genetics favor Reptiles; do they not? The most complex organ in the human body is The Brain. The Reptilian part of The Brain came first. So my hypothesis must be true. We humans favor the genetic code of Reptiles than Mammals. We are a hybrid of multiple species, but we favor the Reptile due to The Brains development being Reptilian. Below is an image of the Reptilian Brain, Mammalian Brain and The Super Sapien Hybrids Brain (Human). The reason we are called Humans is due to different Hues of Super Sapien Hybrids. Hueman (Human). Observe as your world is filled with different Hues of Women and Men. (Funny how the brain resembles a lower case g. Do you think that's why we call god God?)

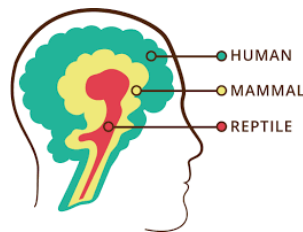

Reptilian Brain

My question is why then are we testing on rodents? I believe that those Gray Aliens are the exact opposite of what they claim to be. I have heard stories that they are Reptile but the fact is why do they resemble Rodents. I believe they have enslaved us on a mass scale and all of our scientific breakthroughs are for Rodents (The Grays). It is time in my opinion to change from Rodent testing to Reptile testing. Why create breakthroughs in the scientific communities for gigantic rats that cannot surface above ground during the day. Their skin is so weak that they are like fictitious vampires. Have you ever seen movies where the antagonists are vampires and burn when the sun touches them. I believe The Grays are real life Vampires. Hence why no one has ever seen one of these Grays in the day time. If you ask me I think we are creating immortality slowly for these Gigantic Rodents who evolved secretly underground. Why are Humans (Hueman) testing on Rodents for Human Cures when they should look at the Genetic Makeup of Reptiles? Moving forward

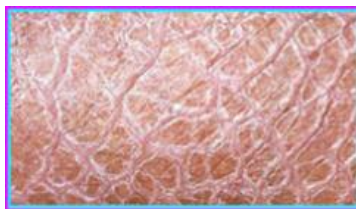

Super Sapien Hybrid's Genetic Favor < Reptile

The image above is an example of what I am discussing. We tend to label skin that isn't perceived as normal a disease. I don't believe this is a disease. Who are you to say what is normal and what isn't. This could be normal in humans than hair. Could Native Americans be more closely related to Reptiles? The Native American's genetic makeup leaves them to bear no hair whatsoever on their fore arms or legs. We are not dealing with a single species we are dealing with a multiple of genetic codes from different species combined into one. My observations are the equivalent to Charles Darwin. Except I am observing Humans (Hueman)

instead of Animals. Charles Darwin was known as an intelligent man because of sheer observation. If Charles Darwin was considered intelligent due to his observations than consider me the most smartest person alive. I have achieved the impossible through sheer observations. I believe that this life has been repeated over and over. These beings that evolved underground tend to keep the evolving animal in a repetitive cycle. Take a look around and observe the many faces of different animal species in humans (Hueman). For some reason I always thought the Asians resembled sharks and fishes. I was at a buffet and I was staring at the man who was serving the food on dishes and I couldn't help but to notice that he resembled an aquatic animal. Being as this may; wouldn't it help our armies by placing the Humans (Hueman) who are in the army in the right branches? For example: if Asians evolved from Fishes than they would be in either the Marines or Navy. Physiologically this is true, for the animal is placed in its natural condition. Natural condition for a bi-pedal walking specimen is the aquatic branch. Humans (Hueman) are made up of different species. Separating and categorizing Humans as different races is absurd. We are different species, for example: African Americans who are indigenous to the Savannah, Native Indians who are indigenous to the Jungles depending on where these species of Humans (Hueman) evolved from places them in the setting that best suits them. Their technology also differentiates with the environment the Super Sapien Hybrid chose as its habitat. Spears are used in the Savannah by the African Americans while the Natives of the Jungle have evolved their weapon of choice into a portable Poison Dart Gun. With the help of the animals in their chosen habitat the Super Sapien Hybrid evolve and coincide side by side with the animals and thus the evolution process continues. Super Sapien Hybrids have evolved with certain technology. This will help The United States of America form the strongest army. Why would I want a Native of the Jungle to carry a Spear when he evolved with the Poison Dart Frog? My proposition is for an army to work properly the heritage and ancestry must be studied. Why would I want a Human (Hueman) who evolved from a Bird in the Marines or Navy? A Human (Hueman) who evolved from the Bird needs to be in the Air force. Our biological structures are complex to where our brains will recognize our suitable environment. This strategy will keep the enemy weak. Each animal has its weakness. I will give an example of Human (Hueman) weaknesses: Let's say hypothetically speaking the enemy in war is made up of Humans (Hueman) who evolved from Fishes. Humans (Hueman) who evolved from Birds is the weakness of the Humans (Hueman) who evolved from the Fish. Birds eat Fish. Biologically this is correct. Our nature kicks into effect when we are in the midst of survival. Having Humans (Hueman) who evolved from Birds in the air force will be the weakness for the Humans (Hueman) who oppose us in War Ships. It is survival of the fittest with Super Sapien Hybrids. We are the Super Sapien Hybrids. I have no idea if technology is sophisticated enough to where our genealogy can be broken down as of 2019 where they can discover what we evolved from and what animal favors us the Super Sapien Hybrid. This proposition will keep The United States with hands on control and leads The United States into victory. Again as a reminder, why would I want a Fish who cannot fly in a branch of war that is Air force? The Bird is the best selection for the Air force. The Super Sapien Hybrids instinct kick into effect when in the air if chosen to be in the air, for only birds can maneuver with no problem in the air. Same thing goes for the Super Sapien Hybrids who evolved from Fishes; their selective branch would be aqua. Nature's instinct will take over physiologically and will help the Marine specimen move throughout its chosen environment; a Super Sapien Hybrid that is aquatic is selected to the Marine branch. I call this Instinct Selection. Question. Do you think an animal that came from water created the net to catch fish? That is evolution is it not. The specimen of water evolved into an upright Super Sapien Hybrid and created a device to hunt its prey much easier. The animal from the water knows its own weakness, therefore giving it the advantage when it has







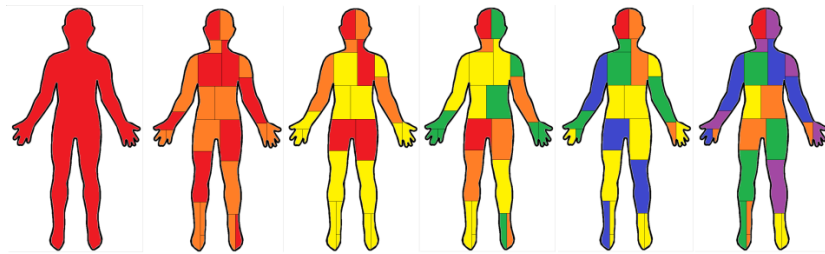



evolved into a Super Sapien Hybrid. Here is another example. A Super Sapien Hybrid (Hueman) who evolved from an animal who has acute hearing would favor the position of listening in on the enemy through surveillance. Why would I want a Super Sapien Hybrid who evolved from an animal who doesn't have acute hearing in a position where the ears are needed for its position? Another example: A Super Sapien Hybrid who evolved with keen eyesight needs to be in a position where a Sniper is being used. Why would I want a Super Sapien Hybrid whose genes favors The Bat? Bats are blind, therefore leaving a Super Sapien Hybrid behind a Sniper Rifle utterly useless. With the categorization of Super Sapien Hybrids ((Hueman) comes the diet of each Super Sapien Hybrids (Hueman). Every animal has a special diet. So does every Super Hybrid species. With the right diets to fit the Super Sapien Hybrid's genealogy will decrease diseases that form the Humans (Hueman) body. It is September 30th 2019 I was in the dining room eating blowing the heat off my oatmeal when my mother walked into the dining room and said "don't you have a proper time to eat". The reason she said this was because it is 2:30 in the morning. Now with this being said, Nocturnal animals thrive in the evening and in night. With the categorization of Super Sapien Hybrids we can have a functioning society where the Nocturnal genetics that The Super Sapien Hybrid favors be placed working at night. Why would I want a Super Sapien Hybrid whose genetic structure sleeps during the night work during the day? Thanks mom. The separation of Human's (Hueman) leaves the creation of extra chromosomes out of the question. Extra Chromosomes create mutations. Mutation is the key word in Evolution. They do not want another chromosome created. I think these beings (The Grays) are trying to keep two species from joining together. A Super Chromosome if you will. This Super Chromosome advances the species into the next level of mutation and evolution. Super Chromosomes take millennia's to form, the more sophisticated the animal the longer the process of evolution. In today's society the word deformity derives from extra chromosomes in the genetic structure. It is considered repulsive and overlooked. When it comes to evolution the extra chromosome is a moment of Eureka. Eureka is defined as a cry of joy or satisfaction when one finds or discovers something. The reason I used the word "Eureka" was because I know it is a word used to gratify a discovery and because it was my favorite show when I was 4 years old (Eureeka's Castle). I loved the puppets. Mutations from these extra chromosomes creates the next step in the line of evolution. With this being said, this does not mean to create controlled environments and breed one another. Although I evolved myself in a controlled environment, I find it very difficult to survive. What good is it to evolve and when the environment is toxic. Although the definition reads that Eugenics was discontinued because of the perversion of The Nazi, The Nazi created the breeding program called Eugenics. Eugenics is defined as the science of improving a human population by controlled breeding to increase the occurrence of desirable heritable characteristics. Developed largely by Francis Galton as a method of improving the human race, it fell into disfavor only after the perversion of its doctrines by the Nazis. Eugenics is a program that breeds humans in order to create a super human. They breed humans in their favor. Its modern slavery on another level. For example, let's say I want a super human calculator and I want that super human calculator to do my calculations. I go to a country such as Asia where the IQ rate is high. I get two Asians with High IQ's. I breed them. Now their offspring is subjected to mathematics and only mathematics. Viola! I have my super human calculator, or perhaps I want a prize winning human in sports. I go to Africa or Russia where the environments is harsh and the species in these environments are strong. I take two from either country and breed them, the offspring is subjected to sports and only sports. Viola! I have my Prize Winning Human. I would have track stars from Zimbabwe winning every track meet. There would be no stopping them. My star's name would be Invader Zim. Why Invader Zim? Well because he is an immigrant from Zimbabwe and immigrants are called Aliens. Sports on

television is a perfect example of Eugenics. They have commercialized Eugenics. This however was not successful. The world's IQ has lowered since The Nazi's victory in World War II. Eugenics, the plan that was marked to become successful was an ultimate failure. The advancements of species must happen in random motion, this advancement cannot happen in a controlled environment. I somewhat contradict myself by saying it cannot happen in a controlled environment because I have evolved in a controlled environment. However the contradiction cancels out due to my evolved state being a new state in evolution, for I have created a form of communication that involves Consciousness, Vibrations and Frequencies. I combined all these together to form Thought Transference T². I believe at one point in time these bi-pedal species lived together in perfect harmony and these rodents underground became powerful and reset earth. They create a big bang, they know the earth has a magnetic field and they know after the big bang the earth forms once again through that magnetic field as do the cells. The cell or cells become tissue and eventually bi-pedal. I have studied on the cellular level and have observed that it takes only one cell to become a multiple amount of cells. Depending on the complexity of that cell determines whether it advances into a new level of its evolution. With this technique on a cellular level, wouldn't you blow yourself up or your home world knowing that you're going to be regenerated? Now that last question was for the sadistic people. I know I wouldn't blow my home world up even after the knowledge that it will join back together again. Keep in mind that Our skin is made up of millions of tissues; tissue is made up from millions of cells. After this big bang our tissue is separated and becomes one cell. Cells are A-sexual; they reproduce by splitting themselves and create more cells. The splitting of the Cells eventually create tissue and eventually create a specimen. These beings have observed cells reproducing and have used this knowledge as an advantage. There is a story that claims that ancient beings came down from space and genetically engineered us from humans. These ancient beings are known to ancient astronaut theorist as "The Annunaki". I don't believe we are genetically modified. 23 (w) Chromosomes are found in Humans (Hueman), while 24 (x) Chromosome are found in Apes. The reason why Humans (Hueman) have 23 (w) and Apes have 24 (x) is because the less chromosomes the higher the sophistication of the animal. The less Chromosomes the more advanced the species. Take a look at the genomes of The Great Ape and you will observe that The Great Apes have more chromosomes. I believe that extra chromosome that separates humans from chimpanzees is many DNA strands from all other animals placed into another chromosome. It is addition that creates sophisticated specimens not subtraction. Separation and Subtraction are defined as the same. Migrating is the key to evolution. With no migration there will be no evolution, when a species remains idle so does their future. The species who remains idle becomes dumb. With everyone mimicking each other they do not advance. Take a look at America and its people; the IQ is very low compared to the countries of the world. The countries of the world migrate while Americans remain in its country. The migrants travel back and forth creating a cycle of their own enlightenment to their countries. Migration is a good thing. America needs to help these immigrants. Its evolution. The necessity of migrants is imperative for human (Hueman) evolution. Systems must be created for the cycle of migrants to receive information and ship information. The cycle of migrants information will advance the human race. Migration is not an infestation. With my understanding of the human genome I can now look at the term Reincarnation with an academic eye. I have never thought about the word Reincarnation with a scientific mind, the term always came to mind in a spiritual form because religion has been the provider of that term in my path as a young child. In order for Reincarnation all the key genes for the genetic structure must be placed in its right lock. The human genome is like a puzzle. All the genetics must be present in order for Reincarnation. When we are born our genetic makeup is ready to duplicate by reproduction. The sperm cell and

eggs in a woman already have the puzzle ready to fit each piece. Take a look at the child you give birth to and you will notice pieces of yourself have combined with other pieces, although you may see some of your genetic pieces in your offspring you also take notice that there are other genetic pieces from your spouse. When I talk about Reincarnation I am discussing the fact that you can be born again. Not in a spiritual manner but in a scientific manner. Our memory cells transfer to our offspring. Our offspring resemble us because they have keys that fit in a genetic puzzle. These keys are the genes and the puzzle is the genetic code. Let's say for example right now I have already reproduced. In 100 years if they choose the right keys and the right genetic structures to mate with I will be born again. How so? Well my offspring will fit venture into new puzzles with their genetic make-up and they to will reproduce. If they reproduce and fit the right genetic keys into the right genetic codes then my genetic structure will become how it started. I don't like using the word Reincarnation for it has spread around the world as religious term. So I call this term that is Reincarnation "Gene's Puzzle". The science community tends to shrug off the term Reincarnation due to its religious origin; I myself have also strayed from using this term due to the fact that it is indeed a spiritual and religious term. This is the advantage that these Nazi have had; they hide their true discoveries behind religious terms. Hence why I named it "Gene's Puzzle". Scientist have categorized genes such as different eye  Color and hair But that's easy to comprehend. Throughout my observations I have identified my friends in strangers. I have a more complex foundation when it comes to genetic structures of The Super Sapien Hybrid (Hueman). I can see their genetic code without any scientific tools.



Gene's Puzzle

The figure above reads from left to right and displays "Gene's Puzzle". As you can see the  [Red 1.1](#) parts of the figure become less dominant after each reproduction with other species of The Super Sapien Hybrids (Hueman), by other species I mean Races; Races are labeled with the  Colors  [Orange 2.1](#),  [Yellow 1.2](#),  [Green 2.2](#),  [Blue 1.3](#) and  [Purple 2.3](#). The different  Colors (Races) are like puzzle pieces to the genetic structure of the Super Sapien Hybrid. Other  Colors also represent different evolution patterns. Notice that  [Red 1.1](#) remains throughout every structure of The Super Sapien Hybrid (Hueman).

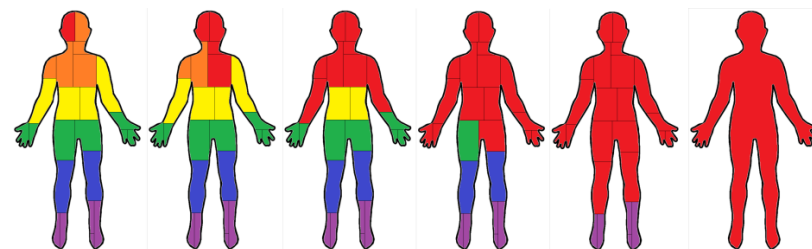

Gene's Reversal

Now let's say after thousands of years, the reproduction of **Red 1.1** becomes the dominant discussion in the human genetic structure once again. **Red 1.1** will become dominate once again and take its original form. How does **Red 1.1** take its original form? Well simple, through reproduction. The genetic structures with original genes that are **Red 1.1** will find themselves back in formation. The figure displayed above is the formation of **Red 1.1** returning to its original state. The Super Sapien Hybrid Puzzle genome pieces must fit in perfect synchronicity in order for its original state to be placed back in order. For example: In the figure displayed above The left hand side is displayed in a manner where **Red 1.1** is but one piece of the genetic makeup. The next piece that **Red 1.1** gains is through reproducing with another that has **Red 1.1** that fits in its genetic structure that places **Red 1.1** in its original place. The many **Colors** replace each **Red 1.1** puzzle piece with every reproduction, but it doesn't mean that it can't gain its original spot in the genetic makeup. I call this process Gene's Reversal. Could Eye **Color** place us in categories from which we evolved from? Animals have mastered the art of camoflaug, Could this be why we have different Eye **Color**? To blend in with our enviornment to keep us safe from predators. Below is an example of what I am asking the student and reader.

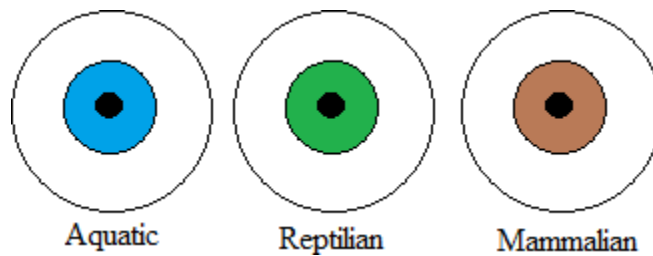

Eye Genus

Every Super Sapien (H) and Animal in this world have different Eye **Color**. Could it be that each Eye **Color** represents a Genus in the animal kingdom? Observe the image below. Could **Blue 1.3** Eyes come from an Aquatic Evolution, Could **Green 2.2** Eyes come from a Reptilian Evolution, and could **Brown** Eyes be that of a Mammalian Evolution.



Classification

There are Super Sapien (H) Mammals, whose genetic code favors Mammals, Super Sapien (H) Reptiles whose genetic code who favors Reptile. I must mention the dietary of Super Sapiens (H) for instance, some Super Sapiens evolved from drinking milk as infants. Some did not. This creates the reason why some Super Sapiens (H) are lactose and tolerant. If a Fish became bi-pedal then they would need not to consume milk. This creates a digestive problem inside the Super Sapien that evolved from a Fish. Super Sapiens that evolved from Reptiles fall in line with the consumption of Milk being a harmful substance when consumed. Each Super Sapien whether a Mammal or Reptile has special abilities. It is not a matter of Psychic abililites it is a matter of what genetics your body favors. My question is: When will Cell 1 genetics structure be placed back into its self in a Super form. Wouldn't it be amazing for Cell 1 to reproduce with Cell 2's offspring or Cell 3's offspring? Wouldn't it be an amazing discovery to see Cell 1 in its true form in a Super Sapien Hybrid form? I believe this being would be the most intelligent. For it has reached a Super form. From 1 Cell to a Super Sapien Hybrid form. What if Stephen Hawking's genetic makeup favored Cell 3, Albert Einstein's genetic makeup favored was Cell 2, and my genetic makeup favors Cell 1, I place it in this order because my calculations rule over theirs making me the most dominant. I believe that I am Cell 1 for I have destroyed an "aliens" rule. It is impossible for me as an ordinary being to destroy an "Alien" or Cell 4. Cell 4 has remained hidden underground hence why it has been utterly impossible for an ordinary person to find out what has been going on. I being Cell 1 am the most powerful and dominant over Cell 2, 3 and 4. It seems Cell 4 was closest to Cell 2 and 3 that it influenced those Cells. Remember Einstein is Cell 2 and Hawkings is Cell 3. With this in mind I Cell 1 went up against the fusion between Cell 2, 3 and 4. Me being the original came out victorious. As soon as I found out my situation; my situation being that I have been under attack by Einstein and Hawkings I immediately wiped their calculations out which led me to the master manipulator which is Cell 4. The "Alien". Below is the scientist explanation of Human Evolution. I believe it is anatomically incorrect hence why I call this figure Anatomically Incorrect.

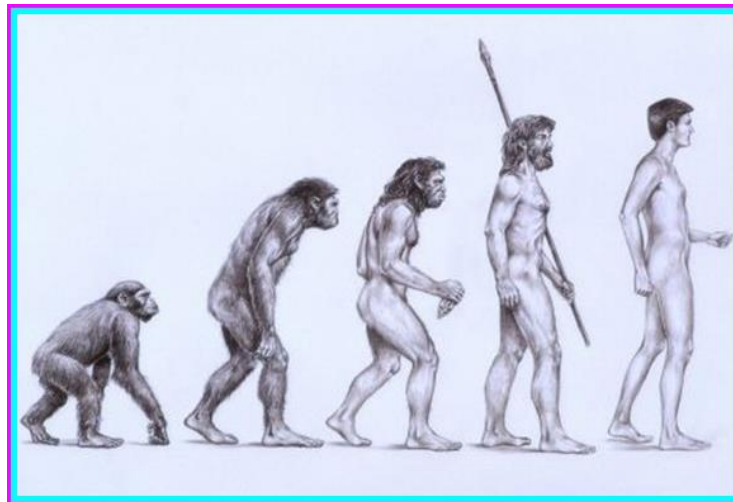

Anatomically Incorrect

The figure above is what man-kind has been taught throughout school. The scientist in the past claim that our closest ancestor is the Ape. We are nothing close to that of an Ape. The anatomy of the Ape is completely different from us Humans. We are a combination of multiple species. If we came from Apes than we would all look the same, just as the Apes do. They believe because

the primate has an opposable thumb that it makes the Ape our closest ancestor. The reptile also holds this opposable thumb. Displayed on the next page is a reptile; The hands and feet of the reptile. This reptiles name is Gecko; also known in the scientific community as Gekkonidae.

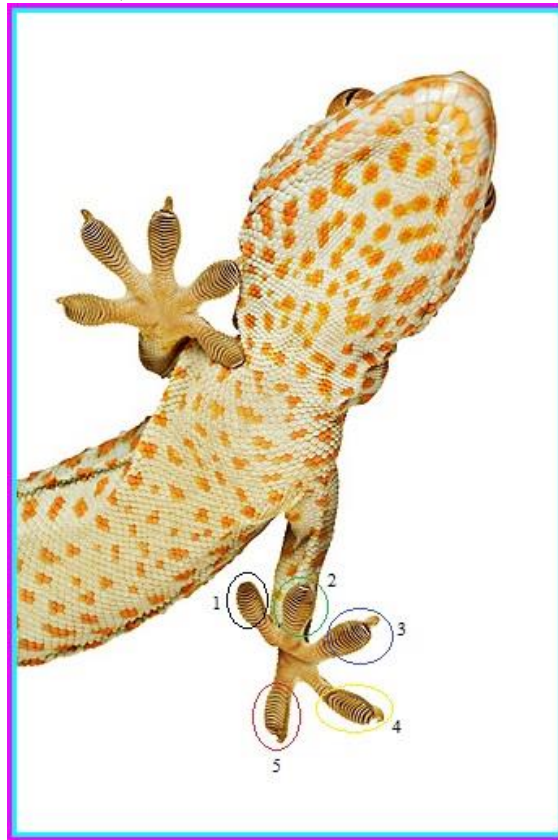

Correction

We as a species are a Super Hybrid, a combination of all the animals that exist. Take a look at the reptile above and you will take notice that this animal also holds 5 fingers on their hands. Their fingerprints have evolved into a Super form. The grooves that we use to identify ourselves have evolved into ways of reaching new habitats with the Gecko. Notice how complex the Gecko's fingerprints are. We are not a direct descendant of the Ape. We do hold genetics of the Ape but to call The Super Sapien Hybrid (Hueman) a direct descendant of the Ape is incorrect. The correct bi-pedal state of the Ape is the Sasquatch. Our bodies resemble nothing of the Ape. The Ape is covered in fur and lives in the Jungle. Not all humans came from the Jungle. As a matter of fact I think it would be hard for a this anatomic level of comprehension that is Evolution-B to be possible. How so? Well for starters think about all the predators that would prey on the evolving Ape. If you believe that we evolved from the Jungle, and from a primate you are incorrect. How could an Ape evolve into a man if the ruling animal was a big cat such as a Panther or a Cougar. Evolution-B is survival of the fittest. This means that the big cats that prowl the Jungle would've reached bi-pedal status before us. But since animals were evolving in other locations such as prairies and islands and what not this made it possible for each evolution path to meet up and mate with one another. Creating what we are today. As I stated before I call our state The Super Sapien Hybrid aka Human. We were not genetically modified by "Extra-Terrestrials" like what Zecharia Sitchin claims and all the other Ancient Astronaut theorist believe and we did not evolve from The Ape. Apes don't have tails, but yet we have "tailbones". I believe tails turned into legs. I found myself in high school moving my legs when a female

classmate would communicate with me. I remember her asking me “why do you always move your legs when I spoke”. I didn’t know how to answer that question at the time. Now I do. Its because I would get excited. You know how dogs wag their tails when they are excited, same concept, but since I don’t have a tail, my legs would begin to move. Now I know why my legs would move after a girl would speak to me. Apes don’t have Tails. We didn’t lose tails, our legs evolved from tails. The Tailbones that humans have also known as the Coccyx is a fictional concept. We never had tails to begin with. The evolutionary lines before us did, but we do not or else we’d have tails right now. Apes correct evolution is the Sasquatch; not humans. I’ve heard stories of people hunting Sasquatches. Could it be the fact that they are trying to eliminate the existence because these men know that these Sasquatches are the evolved upright state of Apes. If I am correct then this means they are trying to keep this a secret by poaching. Maybe those T.V shows of Bigfoot are actual hunting footage and they are selling it to the public as a mysterious subject. In 1 year I eliminated the threat that has been in secret. These people believe the larger the brain the more intelligence. I think this is false. How can an animal with the size of a peanut change its hue for camouflage? How is it possible for an animal to change its texture for camouflage? The Chameleon and Cuttlefish are my examples I speak of. Just because the brain is large in diameter doesn’t mean that it’s any more intelligent. It could be the opposite. Wouldn’t we humans be the oldest and animals such as the chameleon be younger than us. Seeing that our genetic makeup is complex. But I could be wrong due to the fact that I know nothing about the evolution of man-kind. Remember this is my theory but it seems anatomically correct. This literature is 1 year old in the making. If I am correct which I think I am then this means that Cell 1 became light. I have evolved into Light. Since my Cells have been under the sun since it began then this means that I am the Light. This makes since due to Cell 4 living under darkness. Cell 4 lived underground while I Cell 1 lived under the sun. This could explain the term Lucifer as well. When the women’s egg is fertilized by a sperm enzyme a light emits from the egg, the light is zinc. I would be considered Lucifer. But let’s not look at the term in a religious fashion for I am not religious. Lucifer is defined as light-bringing, morning star. My name isn’t Wilson for no reason. The word “Sun” is clearly seen in my name. Wilson. Looking at the term Lucifer in a scientific fashion you will begin to realize that there is only one and I am that one. I believe this is a reason why they are separating humans. If there are less immigrants the quicker they reincarnate a specific human. They know reincarnation but also look at it with an academic eye such as myself.



Genetic Reincarnation

The two people bear the same last name. One uses it as a surname and the other a middle name. The person displayed on the left is Lyndon B. Johnson as a young man, the person displayed on the right is a soccer player named Leighton Baines. The B in Lyndon B. Johnson isn’t a middle

name it is a surname. The resemblance is clear of what I am discussing. This is the same as a cell splitting into another. The reincarnation is clearly seen. All it takes is for Leighton Baines to become a politician and the memory cells of Lyndon B. Johnson will begin to remember his position and his influence. Leighton Baines is 34 years old in the photograph above, Lyndon Baines Johnson is in his early 20s. As you can see these men have been trying to reincarnate themselves through eugenics. These beings have been changing their surnames to middle names. Notice the ears are different but the genetic code is the same. The reason they haven't placed these men who resemble old politicians is because it is too soon to place these men up there. In reality they are waiting for a new generation. In One century this plan could have come into effect, but due to my brilliance I have observed their plans. Gene's Puzzle goes beyond the basic eye color and hair differences that we were taught in school. In reality this is Genetic Reincarnation but I have mastered the art of teach and have replaced the named Genetic Reincarnation to Gene's Puzzle. This is probably the reason why they saved Einstein's brain. It to place his memory in a controlled group of people. The whole time this controlled group is watched and made sure they end up with the right mate who also carries his memory cells. If the mate doesn't reach the other intended mate then an "accident" occurs and the mate that failed to reach a level or reproduction with the other variable that carries Einstein's memory in its genetic code will end up perishing. Science has already discovered gene selection for offspring. If you want blue eyes for your child and have enough funds your child will have blue eyes. If you haven't realized science fiction becomes reality, this means that Frankenstein's monster has Einstein's name written all over it. Spectators from all over the world have come to see Germany Vs. America. First to bat is Albert "The Atom Boom" Einstein, number 12 (AB). The pitcher for home is Wilson "Mr. Fusion" Martinez, number 23 (W). "Mr. Fusion" gets ready for the pitch; a Fastball is thrown by Wilson number 23 (W). Einstein number 12 (AB) makes a direct hit and begins to race for home. Einstein number 12 (AB) makes it past 1st, 2nd and 3rd. Einstein number 12 (AB) slides onto home base but never makes it. Umpire screams "Your Out!" Displayed below is Einstein's brain. What a shame that all is left is his brain.

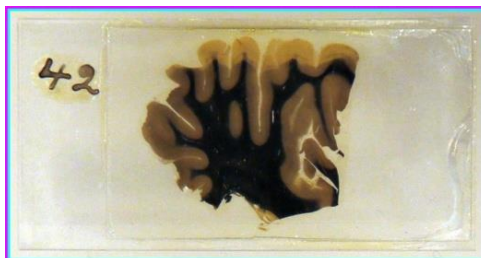

Einstein slides into the Future

Everything that is considered religious can be broken down in a scientific manner. I do understand that Reincarnation speaks about the mind of a person being born again, but like I said this can be broken down in a scientific manner. The mind of person being born again deals with the memory cells of a person. Memory cells do exist, and I'm sure they migrate as well. Immigrants are not an infestation. The infestation is living underground. The foolish militant man who has been helping these "Alien" beings will realize that he is helping himself to a gloomy setting. The foolish militant man has been working for a gigantic hairless, bug-eyed rat. These deep underground military bases are the pipes that the gases run through in gas chambers. These bases will soon be filled with toxic gas that will eliminate and exterminate every militant man and women that live in the bases. Air conditioning is used in these bases. Many air

conditioners are used. Concentrate on what plays out next. These fools have no move but they still seem to squirm around as if their wormholes will save them as I am the Eagle. The Rothschild and Rockefeller are the Jews who indeed have been forcing slavery amongst the world. These families and the families that work with them have been considered the Global Elite. They have been the families who disregard human life and every family member met their demise at the hands of their own family member Hitler. My team simply laid out the foundation of how they were going to rid of their families. Einstein's bloodline met their demise in German Concentration Camps (C²). As did the Rothschild and Rockefellers in World War II. The reason their families were sent the extermination was due to my understanding of Cells. The fewer Cells that created the Einsteins, Rothschilds, and Rockefellers the easier it is to overcome their rule. Beings from the same Cell think the same. The men have created a foolish system. If these men didn't kill off their own family members in World War II in those gigantic fiery pits that engulfed their bodies in flames then this would be a different story. My Children (MC) wait and see what plays out and if it plays out right then that is what our reality will be. Someone who was sent into one of those concentration camps was going to be the next Hitler. Little did they know that they killed him or her in the process of their own destruction and infiltrations of the nations. I wouldn't doubt it one bit that the next tyrant was birthed by Anne Frank. Anne Frank was given a diary before the invasion. These men of the secret order knew her intelligence was above normal and used her to detail her experience during the invasion. Frank being the Frank in Frank Einstein. Let's not forget the foolish sexual innuendo "Frank". Otto Frank sold out his family. He chose fortune over the family. Which is why the next Hilter embodiment will never exist. ■ [Red 1.1](#) and ■ [Yellow 1.2](#) mechanics can be seen in this photograph metaphorically.



Margot Frank and Anne Frank 9/11

The 9/11 metaphor has been used since the 1930's. The Secret Masonic Order has been using the mechanic of 9/11 since before the 9/11 attacks occurred to display dominance over what was going to transpire before the numerology of 9/11 was displayed. The image above was taken September 11th, 1934. As you can see there are two girls in this photo. These two girls are Margot Frank and Anne Frank. The numerology of September 11th is displayed as the date these girls took the photos.



Illiterate translation for Illiterate Powers

The image above was used in and outside Concentration Camps (C²). It is to inform the presidential parties of The United States of America during the wars of what is transpiring in and out of these Concentration Camps (C²). The powerful men of this era were illiterate, hence why Hate is spelled as Hait. It is to translate in a moronic manner. Displayed below is a handbook of an Emergency Response to Terrorism. It is a August 1997 hand booklet. Notice the crosshairs on one of the trade centers. Observe on the top right the SS is displayed above the date.

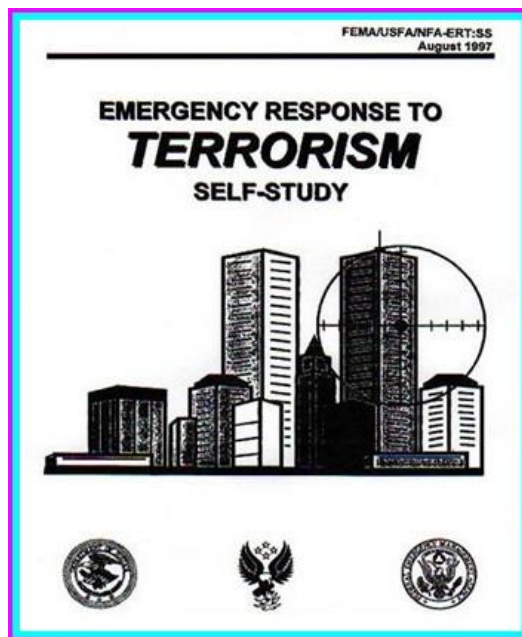

9/11

■ Red 1.1 and ■ Yellow 1.2. In Section IV I discussed the Colors ■ Red 1.1 and ■ Yellow 1.2. The World Trade Centers were built with materials that favored ■ Red 1.1 and ■ Yellow 1.2. The buildings were erected before this handbook. ■ Red 1.1 and ■ Yellow 1.2 means death. If ■ Red 1.1 and ■ Yellow 1.2 means death, wouldn't the image displayed on this handbook confirm ■ Red 1.1 and ■ Yellow 1.2. On the next page is displayed what is left of the Twin Towers. Notice the electric light show that stands before the American people in ground zero.



Ground Zero

The image above is where The World Trade Centers would have been if it weren't for the electricians who installed live C-4 either during its construction in the late 60's or in between the 60's to 00's. Observe the Secret Masonic Order's allegiance to electricity, These men of The Secret Masonic Order either had live C-4 equipment placed in the hands of the electricians to install without consent or had a group of electricians who knew about the live C-4 and installed the live C-4. Either way electricians should be the main focus. For The Secret Order idolizes Electricity. If a mine from the Vietnam era could detonate in 2019, then of course a product of American secrecy could be detonated in 2000. In my opinion, it will always be the electricians for electricity is what has been discussed in a secret fashion throughout centuries. The image below is a man who created a film called Fahrenheit 911 (the word Fahrenheit reeks of German origin.)



Moore, Michael

As discussed in the Second Lightning Strike of this literature a construction company by the name of Moore Construction. Moore Demolition Services is a company that bears the same

name as the name of the director of Fahrenheit 911. The name speaks for itself. More is defined as a greater or additional amount or degree. Notice the Degree in the definition of more. Degree is used by masons to display their rank in brotherhoods. The image below is a demolition company by the name of Moore Demolition, the demolition company bears the mechanics of LT. LT is lightning. It is a German mechanic used by these men of the Nazi Order. The mechanics of two lightning bolts can be seen before the “Moore” surname. The demolition company reads as L.A. Moore LTD. 1 is used as a mechanic for L and A is a mechanic used for 1. The demolition company reads as 11 Moore LTD. In laments terms it reads to the student and reader as II Moore Lightning Demolition. The D is for Demolition.



Moore Demolition Michael

Before I began Dimension Fusion, I found myself working at construction sites. Building homes. I used to build homes with a great man named Nicolas Camarillo. An immigrant, but a great man in general. During breaks or when I needed to relieve myself I would enter porter potties with the name Moore Disposal. I have been observing the world and the fools in this world since the day of my birth. I do not forget relevant actions and relevant items that cross my path. Dimension Fusion is a literature of sheer observations. 9/11 also has Michael Moore’s name written all over it. Moore also has an electric company. Moore Construction is MC.



Moore Disposal Michael



Moore Information Michael

It is no surprise that Michael Moore created films of the tragedy that transpired on September 11th, 2001. Michael Moore the inbred fool strikes out as I, Mr. Fusion number 23 throws an Electric Ball right into the catchers hands. Giving me more power as I influence the world.



Moore Electric

The Bilderberg Group, The Federal Reserve and Trilateral Commission were nothing but establishments and secret groups that now their funds will fund the "Future" or my family. The Bilderberg Group, The Federal Reserve and Trilateral Commission funded the 9/11 attacks. (For I have stolen their riches, hence why I say they are now funding my family.) . No blood relation is required. These men have considered themselves Illuminati and that is indeed the basis of what the trap is intended for. My Sequel Wavelet is a ripple that cannot be stopped. Foolish men and

women in these groups have seen their family members wasted by gigantic machines and hail allegiance to the machine operator who was known as Adolf Hitler. Little did these men and women know that Dimension Fusion is my creation and I hold intelligence and knowledge that cannot be comprehended. These foolish men and women are but sand beneath my feet. As the sun draws nearer to the earth's horizon I Wilson Alzir Martinez grow stronger. By every minute and every day my power advances into a storm of songs that melodies across the nations will be heard. Horns sound in the sky as the nations crumble. Disciples of the unknown will create massive quakes in the ground that create ripples in the earth cleansing the environment. These men and women of secret societies hail allegiance to war and fund wars. My team of intelligence will perform tactics that will reign supreme over these secret groups that have kept my family under a secret order of slavery. These men that are imprisoned in jails communicate and receive messages through Television in prisons. Their own family members and brothers from their brotherhood make sure they take their time to place their brothers in the right prison so communication can be received. These television sets are just like radios. There is no reason to imprison these men and women who are big shots and who are kingpins. They receive messages through televisions. Only the top elites know about telepathic communication and communicate to the future about present events and how to change these present events. Sending these men and women to prison only gives them the advantage of what Einstein referred to as Space and Time. This is the reason why Einstein's book the copy I picked is sectioned off with prisoner stripes. It is due to my Dimension Fusion that I am able to cross Dimensions and MC cross Dimensions as well. Einstein created MC^2 which gave My Children ultimate power. I did not know Einstein was a teammate (sarcasm, of course, is used with that last sentence.) With more Space to occupy themselves, they can converse and plot for when their time is up. These men and women also gain more power through connections of other prisoners. The most intelligent prisoner's families are recruited secretly. They run surveillance on the one who is imprisoned. Running surveillance on men, women, and children who are being enslaved and tortured does nothing to these men and women who are amongst the elite. Killing them is the only option. Let's face it you haven't been saving anyone from enslavement by throwing the ones who are enslaving in jails. If anything running surveillance helps those amongst the elite because they listen to your surveillance and create plans that go around your plans. These men and women whom you listen to on a daily that are screaming for help would rather be put out of their misery than listened to. A lot of these men and women are told this. That their screams will never be saved. This is the reason why killing these men amongst the elite is the only option. They speak to "Extra-Terrestrials" through their consciousness. By putting these men and women in prison you are helping them by giving them Space and Time. Space-Time Continuum doesn't always necessarily mean Space.

Section IV



The Heavens

The Heavens

Am I the only one who knows about the Sophisticated Mushroom we are living on? Through my observations I have observed the “Stars” in the sky. In my perception they resemble bright Diamonds. I have stared at the night sky so much that I began to question the master piece that is sitting above me as I lied down in the grass. It is with my pleasure to paint a picture with my words and create another perception to the student and reader, comprehension isn’t necessary when it comes to this picture that is going to be displayed as words. Keep in mind imagination is going to be the factor. Displayed below is an image of a Diamond; or should I say a visual metaphorical resemblance to that of the “Star” in space.



The Star in the Sky

It is my belief that the “Stars” in the sky are equivalent to Diamonds on planet Earth. Diamonds as small as they are emit a gigantic gleam when the light rays hit the Diamond at an angle. This

is the same effect that takes place in Space. Imagine having Diamonds on a black sheet of paper; now imagine those Diamonds being hit by light. They will begin to reflect the light and create a magnificent light show, just as displayed up above in Space. The reason planets send a glimmer is because of their Element. Earth also gleams and shines, Earth is made up of many elements. I believe Earth emits a beautiful gleam from a distance. If we were millions of miles away Planet Earth would shine Blue. Why Blue? Well simple, because the water on Planet Earth is greater than the land. The sun is the light and the rocks in Space are the “Stars”. “Stars” are not Gaseous. They are nothing more than “Giant Diamonds” gleaming in a black backdrop. Think about it. As small as Diamonds are, the display of light reflecting of the Diamond is bright. At night when you have a chance take a look at the night sky. Take a look at each star. Do you really think those stars are made up of Gas? If they were made up of Gas they would not emit light beams toward Planet Earth. Like I said, Imagine a Gigantic Diamond in Space, and you will begin to realize that “Stars” are not “Stars” but they are “Rocks”. A Diamond is a rock by the way. I will continue the discussion of the “Stars” later in this section. Now, let’s talk about Gravity and Huemans. Einstein and his men believe that Gravity is created by a rotating body. That the reason we don’t fall up into the atmosphere and ultimately into space is because of the motion of the rotating body that we Huemans reside on. Einstein is wrong again. We as a Super Sapien Hybrid Species are made up of different Elements. This includes Metal. (Everything biotic is composed of Metal.) Iron, Calcium, Copper, etc. The Earth’s Core is that of a gigantic Magnet. The Earth is not rotating. Gravity is created by the immense size of the Core of the Earth (or the Metals of the Earth) and the amount of Metal that is in the object free falling. Question. What falls faster? Styrofoam in the shape of an Atomic Bomb that weighs 10,300 pounds (4,700 kg) or an Atomic Bomb that weighs 10,300 Pounds (4,700 kg)? If you chose The Atomic Bomb that weighs 10,300 pounds (4,700 kg), you are correct. The magnetic force from the Earth pulls in Metal at a faster rate than any other Element. 12 is the number of Elements that are in Huemans. 12 is also a recurring number used by the Nazi party. 12 is a foolish number that has no significance in this reality. It is just a number. Nothing more, nothing less. Either the number of minerals in the human anatomy is fictitious (I place my bets on 12 minerals in the human anatomy being fictitious; 12 is AB and pays homage to the Nazi party.) or the Hueman anatomy must be reexamined. The reason objects fall onto the earth is due to the Magnetic Force of the Earth’s Core and Earth’s biological make-up. Earth is made up of many different Metals. They repel and attract. The larger the body of Metal, the larger the Repel or Attraction an object has towards the Earth. Making Einsteins $E=MC^2$ look foolish once more. The equation for Gravity is displayed later in this section. If the rotating body (Earth) was spinning at a rate of 1,000 mph as the scholars think, then the airplane would be destroyed on takeoff. It would be ripped to shreds. The airplane would find itself being forced down by the rotating body’s massive force. Therefore leaving the theory of the rotating body creating Gravity a dud. The Earth stands still. NASA has created an illusion by sending a video of satellites rotating the Earth. The Earth is not rotating; it is the satellite that rotates. The Moon (Earth’s natural satellite) rotates around the Earth in a Space between neutral. The Moon sends out negative and positive polarities. Earth and Sun are displayed as  [Ultimate 1](#). The Magnetic Neutral Zone is displayed as the Rainbow.

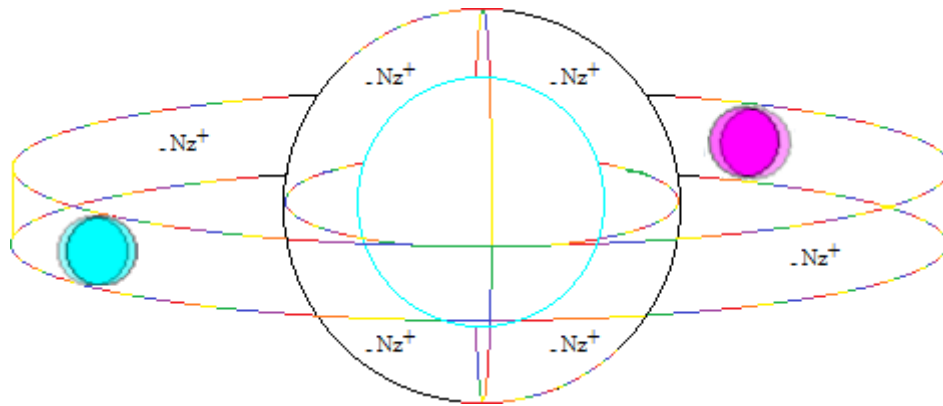

Neutral Zone

The figure above displays the Earth's natural satellite (Moon) in the **Color** format **Seismic** 2 it is in rotation due to the magnetic forces projected via both celestial bodies. The Earth's natural satellite is in orbit giving off a display of rotating bodies. The figure above displays Earth's natural satellite (Moon) off in the distance in a rotation outside Earth's Neutral Zone (-Nz⁺). Earth's natural satellite (Moon) gives off its own Neutral Zone (-Nz⁺) leaving the celestial bodies exerting the same forces leaving the celestial bodies in a state of equilibrium. Equilibrium is defined as a state in which opposing forces or influences are balanced. Question. Does a satellite rotate when in orbit? It is in between polarities of magnetic forces. Giving its "Frozen" state. By "Frozen" I mean no movement other than its providing atmosphere. This atmosphere I call "Neutral Zone". It is basic physics. The satellite is a Metal. The reason it doesn't fall down to Earth through the magnetic force is because it is in a location where the Earth's Magnetic Force affects it not. It is in a perfect location where Earth's Magnetic Force does not reach. Even if Earth didn't have a gigantic core made of a Metal that Attracts, The Earth's Magnetic Force still takes effect for the Earth is made of many Metals. All the Metals that are in Earth create the massive magnetic force. All Metals of the Earth are in perfect synchronicity which creates a Neutral zone. That Neutral Zone is where the satellites are located. It is a means of Negative and Positive. The Negative Metals repel, while the Positive Metals attract. These two create the Atmosphere where satellites make their round trips around Earth. There are Positive Metals and Negative Metals. They create Gravity. The equation displayed on the next page defines the status of the Neutral Zone. The equation translates to Negative Metal (N_m-) plus [a] Positive Metal (P^{m+}) Equals (/e/) Neutral Zone (-Nz⁺). What is a Z but an N tilted.

$$Nm - [a] Pm + /e/ -Nz +$$

Magnetic Neutrality

Imagine creating a model of Earth with compressed metallic material. The compressed metallic material projects polarities of Negative (N_m-) and Positive (P^{m+}). With these polarities compressed against each other they in turn project outward a Neutral zone (-Nz⁺). If the celestial body is composed of Positive components without Negative components Earth's natural satellite (Moon) will find itself stuck onto the celestial body (Earth). There must be both Positive and Negative in order for this type of solution that is given to us in a habitable form. Polarities is defined as the relative orientation of poles; the direction of a magnetic or electric field. Displayed in the diagram below is a visual of Magnetic Neutrality.

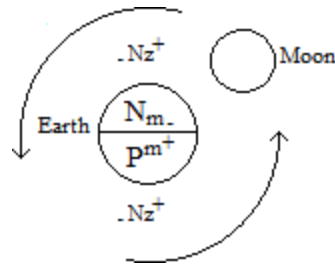

Gravity

The diagram above displays what is transpiring between the Earth and The Moon. The polarities on Earth that create a Neutral Zone. The moon is displayed as being in the Neutral Zone. An orbit if you will. The Sun must have the same force but in a concentrated fashion that keeps it in orbit with Earth. Displayed below is the Sun with the same calculative format. The Neutral Zone keeps these bodies from crashing against one another. Leaving them in a position of orbit.

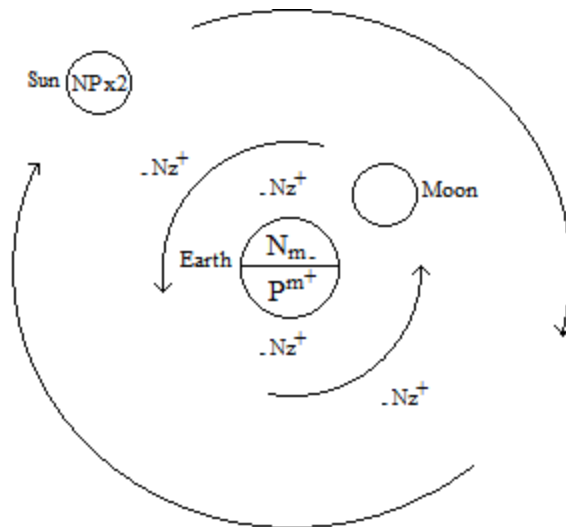

X2

The Sun has the same force but it seems as if it has an x2 effect with its polarities keeping the distance in a habitable location. The “Stars” that are in space also repel and or attract with Polarities Negative and Positive. Those Rocks (Stars) remain in the same positions due to magnetic forces in between each Rocks (Stars) creating the same layout every night and day. As you may have noticed the constellations we have created remain and never change. This is due to the Rocks (Stars) with magnetic fields that keep them in their positions. Light Waves and Magnetic Waves are in the same category. They go hand in hand. The Light Waves emitted from the Sun figuratively speaking mask the Magnetic Waves, for those Magnetic Waves are not seen by the naked eye. Those Magnetic Waves from the Sun are emitted throughout the Solar System just as the Light Waves are emitted. Just as Light reflects back on towards itself, so does the Magnetic Waves. Only difference between Magnetic Waves and Light Waves is Light Waves are visible, and Magnetic Waves are not. Light Waves shed light on the world, therefore being visible to the naked eye. Could it be that the Sun emits so much Light towards the Rocks (Stars) that surround the Sun that the Rocks (Stars) reflect back towards the Sun, creating a massive intensity of heat? This could be the reason why the Sun emits so much heat. The Sun is that of a

gigantic mirror, so are the Rocks (Stars) which reflect back towards the Sun that of a gigantic mirror. The Sun reflecting outwards begins to collect inwards. Light Waves are reflected back and forth. Somewhat like microwaves. The “microwaves” that are projected back and forth from the Sun are in equilibrium, leaving the Sun in a personified trance. Heat waves can clearly be seen by the naked eye. Those heat waves reflect upwards creating a wave like motion from the ocean. The Rocks (Stars) that gleam with such brilliance give thanks to the Sun by sending Light Waves back towards The Sun. The Rocks (Stars) shine through the Sun’s Light Waves. I am not denoting the fact that there could be other celestial bodies that are similar to our Sun; I am simply stating what fact is. The Rays of the Sun we capture with our cameras might be those exact reflection beams that are being sent outwards from the Rocks (Stars). We see them as Rays of Light, but they are indeed those beams of Light that are being sent from those Rocks (Stars) in orbit. The Earth does not Orbit the Sun. The celestial bodies are in perfect alignment where they are all in a state of motion. The Rocks (Stars) transmit magnetic forces keeping the Sun in a state of motion from those magnetic forces. The Sun follows suit and transmits magnetic forces, the Earth as the recipient receives those magnetic forces from the Sun. The Moon is in a position where the magnetic forces are transmitting and receiving via The Rocks (Stars), The Sun, and The Earth, leaving it in its position orbiting the Earth. The Sun must be made up of some extraordinary Element for it to produce such incredible forces that leave the celestial bodies of The Heavens to transmit and receive magnetic forces. The diagram below displays the magnetic forces that are created by distant magnetic forces both repelling and attracting.

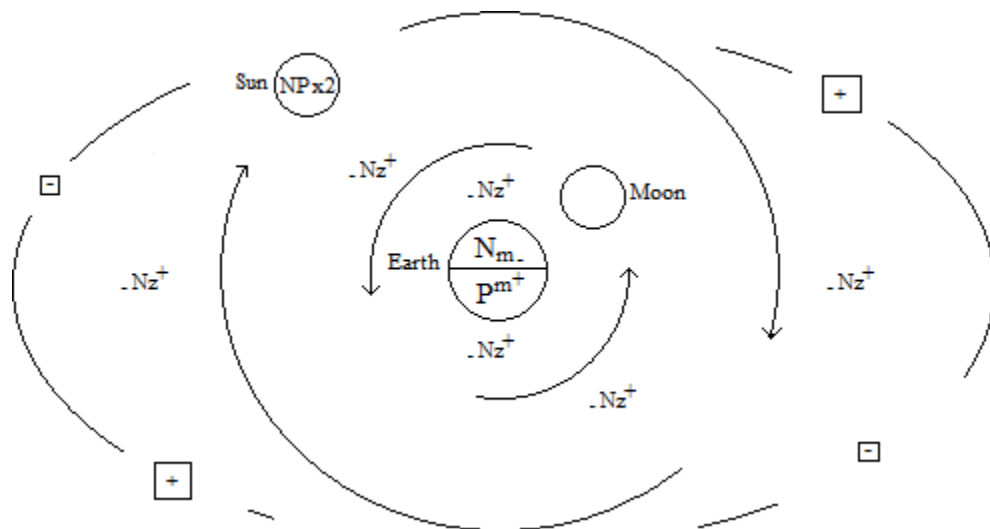

The Heavens

I, Wilson Alzir Martinez as The Musician of the Heavenly Symphony have identified the Conductors; (New) Elements in the Heavens. The “Stars” are displayed on the previous page as Sq2Ds; These Rocks (Stars) in the Heavens create a Neutral Zone themselves and create an elliptical orbit around other gigantic magnetic bodies. The polarities in the Heavens are in equilibrium and remain in perfect synchronicity, with no disturbances. Each one of those Rocks (Stars) in the Heavens above creates a massive magnetic field. With Conductors; (New) Elements that haven’t been discovered, the Heavens above hold keys to new sciences. The Heavens above might hold Conductors; (New) Elements that are the size of nickels but project incredible polarities of Negative and Positive. During the day I have noticed the Sun being almost the same size as the Moon. Why is that? I have observed the Sun with the naked eye. I used the clouds as my shield to observe the Sun. Through my observations I have observed the Sun being almost identical that of the Moon. With my observations of the Sun and its Dimension

I estimate the Sun's distance from Earth being similar to a light bulb above a generic ecosystem. The distance given to me by my superiors is estimated at roughly 92.96 million mi. The Dimensions don't add up to the analytical statement of 92.96 million mi.

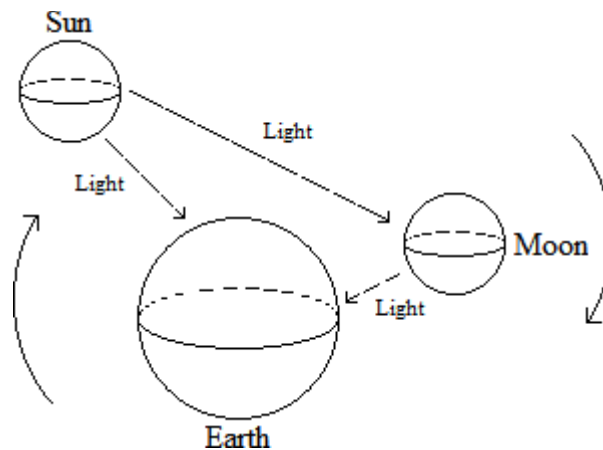

Celestial Twins

The Sun emits light waves that shine on both The Earth and The Moon. Water from The Earth reflects the Sun's light waves and The Moon's light waves. Earth's water then creates an illusion of the Heavenly Celestial Twins. Observe at times that The Moon grows the same size as the Sun. The Sun does the same as it sets and vice versa. The Sun and The Moon are identical in diameter but carry different strengths. The only reason the Sun looks much larger than that of The Moon is due to its intense energy that The Moon lacks. Mother Earth and its Twins keep the cycle of life in rotation as life continues to progress forward. The Sun emits while The Moon reflects. The Sun sends out an intense magnetic and light waves, while The Moon acts as an absorption module. Absorbing the intense waves from The Sun, and reflecting the same waves in a weaker status towards The Earth. Make your own observations of The Sun and Moon and you will identify their growth in size as The Sun sets and The Moon rises. As The Sun sets it grows in size, as The Moon rises it grows in size, however when The Moon rises at its full peak it is at a normal size. The Sun at its peak also follows suit. They are in a state of equilibrium that cannot be matched. The Twins remain in a harmonious rhythm. When the time is right they fuse together and create darkness. They are identical in size, therefore giving The Twins the right to form an Eclipse. The Sun must be composed of a multiple Elements vibrating against one another which in turn create its intensity. There must be an unknown metal that hasn't been discovered, that has a giant magnetic force. It doesn't repel, it attracts. It is a new element. This new element will be called Ea. Earth. The world's strongest element. It could be the key to another form of transportation or cures. It might have the same effect that Gravitational Acoustic Levitation (GAL) has. Anti-Gravity Metal. Manipulating a Metal that does nothing but attract could create the biggest repel effect. Please correct me if I'm wrong. Earth does have a magnetic field. A navigation compass will place all doubts aside to the non-believer. (This is a perfect example of how reverse engineering works. The reversed calculation that is $E=MC^2$ is returning to its natural state. It is my understanding that every stolen mechanic from the future becomes whole and in its correct place, for example EMC is a mechanic from Einstein's future. It is a mechanic I discovered on October 18th 2019 at 10:30 P.M. Einstein's men reversed engineered this mechanic that landed in their time period. It is October 18th, 2019 and I got my EMC back. I am the creator of the technology that is being used throughout the world. These fools fall into my traps by reverse engineering my technology.) The comprehension of Gravity is displayed below

in my beautiful equation. The equation is translated as Earth's (E) Magnetic (M) Core (C) equals (/e/) Gravity (G). The fools didn't know what the G meant so they substituted the definition for German. Fools. It is neither Mass nor Constant that sums up to Energy $E=MC^2$, this is a fictitious statement and a fictitious equation. EMC is the correct equation for the reason why Energy is created. Earth's Magnetic Core (EMC) pulls Mass (M) towards its body creating Velocity or Constant (C) equaling the amount of Energy (E) that the Earth's Magnetic Core pulled onto itself. That explanation places the ² above EMC, for you are seeing another variable for each constant. The equation $E=MC^2$ is a reverse engineered mechanic that the fools who discovered it could not comprehend. Leaving those who discovered to create a definition for the EMC. It's cheating. With reverse engineering mechanics the fool goes nowhere. My Dimension Fusion eliminates Einstein's Space-Time Continuum. Therefore leaving his calculations and who ever follows in his steps of "brilliance" eliminated. I as the Predator identified my Prey and I have begun the hunt. My sciences and my expertise is above and beyond comprehension at times, but with a sense of awareness of the surroundings that the student and reader faces will become comprehended. The equation is not $E=MC$ it is EMC. Foolish men and their reverse engineering lead them nowhere. It leaves them in a dark abyss with no end. Below is the equation for Gravity.

$$EMC/e/G$$

Earth's Magnetic Core equals Gravity

The Heavens remind me of the inner workings of a clock. As one gear rotates a section of the clock, another section of the inner working of the clock follows suit. With gears working in formation, the clock begins to tick. Celestial bodies are the gears and the Universe is the Clock.

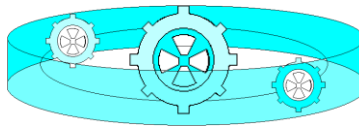



Space-Time Continuing

The figure above is my definition of the Space-Time Continuum. It is a visual representation of the celestial bodies (The Earth, Sun and Moon) in Space. Each Cog (celestial bodies; The Earth, Sun and Moon) works in the favor of the other Cog (celestial bodies) that are in motion. Do you think Einstein knew about the rotation of the Universe and came up with the same conclusion? That the Universe reminded him of the inner workings of a Clock. Hence why the metaphor/term Space-Time Continuum was created. However I do believe that I have a full understanding of the Universe as a whole. Einstein on the other hand knew that the Earth rotated around the Sun. That is incorrect. For the Sun is in a cycle of its own. It is physically impossible for our machines in this age to capture the Earth in its rotation for we are in a rotation as well. The rotations of other celestial bodies that force gigantic magnet polarities keep us in a state of motion. Our primitive technology cannot keep up with the giant magnetic force that has the Universe as a whole in motion. For NASA to say that they have achieved proper co-ordinates and proper calculations to send a vehicle towards Mars is absurd. According to NASA the celestial body Mars is 33.9 billion miles away from Earth. With the Universe as a whole in a state of non-stop rotation, makes the "precise" calculations of NASA false. Our Moon for example changes its position constantly. This makes it very hard to believe that NASA can honestly say they have achieved a landing on another celestial body. Take this Analogy for example. We are Cells living on a

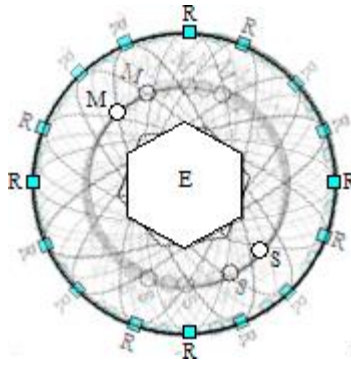
Pollen particle caught in a Tornado. We are to Cells as Earth is to Pollen. Pollen is to Earth, as the Tornado is to the Universe's giant magnetic field. Do you think a Cell with the sophistication of Humans whom can calculate has a chance of landing on another piece of Pollen in said tornado? I think not. To think that these fools at NASA have the proper calculations and precise measurements for celestial bodies is absurd. Rubbish I say. Complete rubbish. The calculations that NASA has established as being 100% accurate are nothing more than fictitious. The metal of the machines we send to the celestial body of Mars could be repelled from the celestial body called Mars. It isn't about how fast you are going to break an atmosphere. That calculation might be precise with Earth for we have the correct Metal that lets our machinery become attracted towards Earth. We are composed of the same Elements on Earth, giving us the best understanding of Earth's Gravity for we are one with the Earth. It is about the correct Element the machinery is made out of. Suppose I send a vehicle that is made of Copper. Suppose that the vehicle that is made up of Copper is being sent to the celestial body Mars. Let's say Mars is made up of material that is equivalent to magnets that attract Iron, Cobalt and Nickel. The Copper vehicle that was sent would never land for the vehicle is created out of Copper. Copper is not attracted to magnets. Gravity is not created, due to the vehicle being made of Copper. The celestial body that the vehicle is sent to is only attracted to Iron, Cobalt and Nickel. Gravity is created by the magnetic pull that the celestial body has. No matter how fast I send this vehicle that resembles a nano-bot to that of the gigantic celestial body of Mars, my vehicle made of Copper never achieves a successful landing. Therefore reaching the conclusion that Mars isn't attracted to the Copper vehicle. It is similar to sending a vehicle that emits a positive magnetic polarity towards another positive magnetic polarity. These polarities do not attract. With this being said it is the equivalent to sending a Copper vehicle towards Mars. In laments terms, if I send a vehicle with a positive magnetic force towards a planet that emits polarities of positivity than the vehicle would never reach its destination. The understanding of magnetic forces must be precise before sending any vehicles towards other celestial bodies. The celestial destinations that vehicles are sent to must have the correct polarity projecting. With the wrong polarity the vehicle will never reach its target. Think about a magnet with a polarity of positive and another magnet next to said magnet with a polarity of positive. The same polarities keep the magnets from touching one another. The calculations wouldn't matter if you were trying to enter a celestial body with a positive polarity. The magnetic polarity for that celestial body pushes the vehicle off in the opposite direction. If you think velocity as anything to do with breaking an atmosphere you are incorrect. It is all about magnetism and what the celestial body is composed of. In this part of the discussion velocity doesn't exist. This next example eliminates Einstein's Light Speed theory. A vehicle with a velocity of 186,000 miles per second would never reach a celestial body (celestial destination) with an opposite polarity of said vehicle going at the rate of the speed of light. The celestial body (celestial destination) has a magnetic force that keeps the vehicle traveling at the speed of light from entering its atmosphere. If you ask me the word "Atmosphere" relates to the magnetic forces that are in this discussion. Speed of light is a measurement not a rate. Making the speed of light sound and look ridiculous. Below I display the universe in its magnetic orbit. It resembles that of an Atomic Molecule.



Celestial Atomic Revolution

As I rev up my engine, my Celestial Atomic Revolution diagram is presented for the world. The C.A.R. or Celestial Atomic Revolution that is displayed above shows the Universe's movement. The Rocks (R) that are displayed as Sq2Ds' with the  Color format of  Ultimate 1 are in a formation in which they hardly ever collide against each other. This doesn't mean that there aren't drifters in space. By drifters I mean asteroids. These asteroids are created by magnetic forces of Rocks (R) in orbit amongst one another. The magnetic clash of two Rocks (R) creates the asteroid. The polarities of these bodies are attracted to each other creating a gravitational force in space. This gravitational forces leads to a crash, after the crash of these two forces, a polarity of the positive then sends the asteroid that was created by the two clashing bodies in a forward motion creating velocity. The Drifters in space that land on Earth are of the same material that of the Earth (E). Earth's (E) attraction to the drifters in space is pulled into its body due to the magnetic force that Earth (E) produces. An Asteroid is created by the amount of magnetic force that pulls the asteroid. It is somewhat the same as dropping a heavy metallic object from the sky in a vertical position unto Earth, the only difference is the asteroid would be moving horizontal instead of vertical, depending if another celestial bodies magnetic pull is stonger, in this case the asteroid changes direction at a higher velocity. Ultimately changing the direction the asteroid was headed. Objects do slow down in space. There are magnetic forces that project Negative and Positive polarities all around the Universe. The Sun (S) and Moon (M) are in a magnetic field themselves. Every so often a Rock (R) pushes with its magnetic force against the Sun (S) and Moon (M), which in turn creates our seasons. Sending vehicles towards long distances without the knowledge of our Universes magnetic forces creates a giant failure. Hence why I created the C.A.R. or Celestial Atomic Revolution Before we as a species begin to send vehicles to venture out in the depths of space, we must study the cosmos at a molecular level. Take a close look at Atomic Molecules and you will begin to see the pattern that the Celestial beings above have created. The Nucleus is surrounded by Electrons and Protons. In the Celestial Atomic Revolution diagram displayed above represents the Atomic Molecule, with Earth (E) representing the Nucleus, The Sun (S) and Moon (M) representing Protons and Neutrons, while the Electrons are in orbit around the Nucleus. We have the tools that can create the same orbit able patterns with magnetism. We must begin at an Atomic level before we the journey towards the Universe. Space travel is really easy once the studies of magnetic forces are comprehended at a celestial level. How so? Well, take this for example: I'm leaving planet Earth and I've set forth towards Space. I've studied a celestial body (celestial destination) and its components that it is composed from. My vehicle is created from those same components, therefore making my journey to that celestial body (celestial destination) that much quicker and safer. Saving me fuel. Transportation via magnetic pull if you will. My vehicle is projecting a negative polarity, the celestial body (celestial destination) projects positive. The celestial body (celestial destination) I

am traveling towards eventually pulls me into its body. The use of magnetism is a key factor in Space. The problem one might face is other moving bodies (asteroids) in space that might project the same polarities towards the vehicle. If a polarity is the same as the vehicle then my vehicle would be pushed off course.



Celestial Travel

Displayed above is a path that ventures toward a celestial body (celestial destination) that projects a positive polarity. Space travel is easy to comprehend once magnetic studies are done out in the vast reaches of the unknown. The comprehension of Space travel begins with magnetic forces and pulls from those magnetic forces. The ■ [Blue 1.3](#) body on the diagram is Earth. The vehicle that ascends from Earth is presented in ■ [Yellow 1.2](#); the vehicle projects a negative polarity. The ■ [Red 1.1](#) body is the celestial destination that the vehicle is sent forth towards. Positive attracts Negative and vice versa. As you can see the path of the vehicle is pulled rapidly by the celestial destination. Here is another example just to tickle the brain on magnetism. What falls faster on Earth? A Feather with the approximate weight of 74 grams (2.86 ounces) or a Feather made of metallic material with the approximate weight of 74 grams (2.86 ounces)? If my calculations are correct, then the Feather made up of metallic material with the approximate weight of 74 grams (2.86 ounces) falls at a faster rate than the Feather. The equation $E=MC^2$ does nothing more than create an abomination on mathematics as a whole. If $E=MC^2$ is correct then why does the Styrofoam in the shape of an Atomic Bomb with the exact weight of 10,300 pounds (4,700 kg) create no energy. The Atomic Bomb creates an explosion and the Styrofoam in the shape of an Atomic Bomb does not. Below is an art piece of the universe and the Earth. Earth reminds me of a fungus. A sophisticated mushroom.

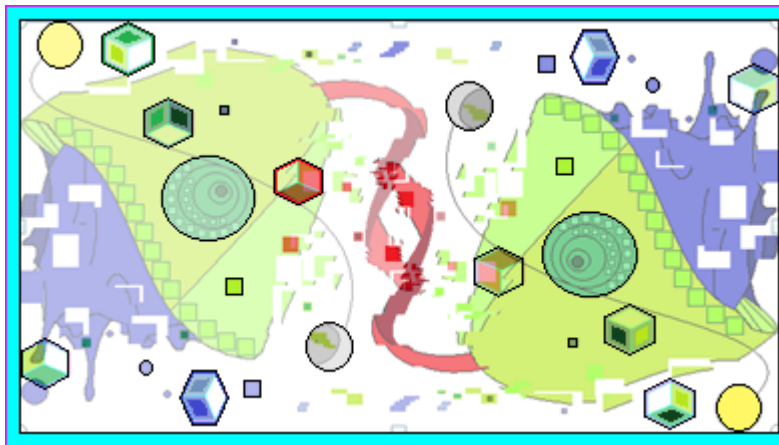

Sophisticated Mushroom

With much sophistication, planet Earth begins to set in a motion towards light. We are living on a gigantic organism. We are to Earth as parasites are to Fungi. It doesn't surprise me that one of the most powerful weapons (Atom Bomb) on this planet creates a Mushroom Cloud (MC). A quick question before I close out this section. If I am traveling towards a celestial body, with a negative polarity, at the speed of light (186,000 miles per second; 300,000 Kilometers) with my vehicle projecting a negative polarity, would the speed of light break the atmosphere of the

celestial body that my vehicle is traveling towards? The answer is no, for the speed of light (186,000 miles per second; 300,000 Kilometers) is a fictitious rate that will never be used in Space travel. The speed of light is an incorrect calculation. I am halting a blockade in the future with this next paragraph. In 100 years or so when light speed travel might be possible, we will run into a problem. The problem will be magnetic forces from celestial bodies we are venturing towards. The speed of light will be useless. For those magnetic forces will not allow us to enter the celestial body's atmosphere. How so? Well let's say Mars, the celestial body we tend to terraform in the near future is composed of an Element that pushes every Earth Element away from its body. (This is the reason why the celestial body Mars is so far away. It is due to its Element. Suppose Its Element is that of a positive and Earth is also that of a positive. Two positive polarities never touch one another.) The vehicles we use are all composed of Elements from this planet. They do not correspond and are not attracted towards the other planets in our system. To say that light speed travel will enable us to reach other celestial bodies is foolish. If we lived on Mars and made vehicles with Elements that are not attracted by Earth, and traveling at the same rate of light speed we will never reach Earth, For Earth is only attracted to Earth Elements, and our vehicles are composed of Mars' Elements. Light speed travel is nothing more than another way to buy time for an unseen agenda that the world's powers do not see. It will be possible to travel at the speed of 186,000 miles per second (300,000 Kilometers), but to say that it is the key to Space travel is nothing more than fantasy. There are three scenarios. The first scenario is the vehicle is sent off course through the magnetic field. Below I display the failure of light speed.

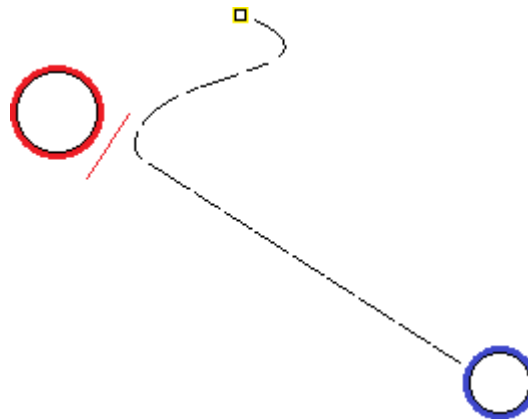

Dim Light Speed

It isn't called the ■ [Red 1.1](#) Planet for no reason. ■ [Red 1.1](#) means to stop, does it not? Mars pictured in the ■ [Color](#) format ■ [Red 1.1](#) emits a magnetic field that doesn't correspond with any Earth Elements, making The ■ [Red 1.1](#) body (Mars) in the diagram unapproachable. Earth is displayed as ■ [Blue 1.3](#), the vehicle traveling at a rate of 186,000 miles per second (300,000 Kilometers) is displayed in ■ [Yellow1.2](#). The vehicle is sent off course due to the magnetic field that is emitted from the ■ [Red 1.1](#) celestial body. There are different Elements in space. Different attractions. What is the use of shooting a bullet towards a target when the target is wearing a bulletproof vest? My bullet traveling at a rapid rate never pierces the metal. It bounces off. Same thing happens with these three variables: The speed of light, a vehicle and a celestial body. The vehicle traveling at the speed of light never reaches the celestial body. The magnetic force pushes the vehicle towards the opposite direction. The second scenario is the vehicle gets

caught in an orbit due to the magnetic force of the celestial body. Displayed below is scenario two.

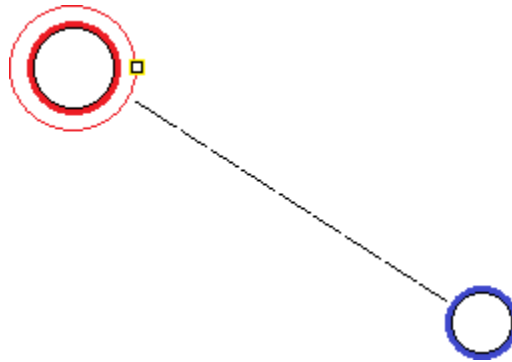

Eternal Orbit

The second scenario is displayed above. The ■ **Red 1.1** planet (Mars) might emit a magnetic field in which the vehicle displayed in the ■ **Color** format ■ **Yellow1.2** is caught in an orbit in which it cannot escape. Making it impossible for a safe return.

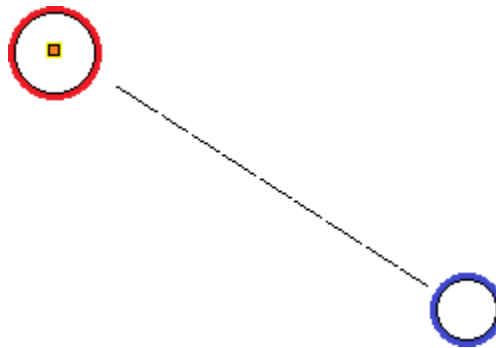

Magnetic Crash

The third scenario can be seen in the figure above. The ■ **Red 1.1** planet (Mars) might emit a powerful magnetic field that attracts the vehicle into a crash course. The vehicle displayed in the ■ **Color** format of ■ **Orange 2.1** signifies the crash of the ■ **Yellow1.2** vehicle. The reason it is displayed in the ■ **Color** format of ■ **Orange 2.1** is to display death. ■ **Red 1.1** and ■ **Yellow1.2** equal ■ **Orange 2.1**. Traveling at a speed of 186,000 miles per second (300,000 Kilometers) into Mars' magnetic field (giving the fact that Mars has a strong magnetic pull) will double in and around Mars' magnetic field. If the vehicle is traveling at a rate of 186,000 miles per second (300,000 Kilometers), the speed is multiplied by two at a rate of 372,000 miles per second (600,000 Kilometers) creating a much faster speed and eventually crashing onto Mars' surface. The end result determines an abundance of miscalculations. These diagrams that are displayed remind me of a pendulum. As the pendulum weaves from right to left the clock ticks. It doesn't surprise me that the Swiss miniature watch was established in between 1503 and 1530, centuries before Einstein's Space-Time Continuum. Shouldn't the creation of the Swiss miniature watch come after the Space-Time Continuum? Einstein moved to Switzerland 1895. If you ask me I think these scientists are creating faster nuclear arms, with these calculations that are incorrect. These scientists are not reaching for space. That is an illusion. They are creating faster technology for world domination. The brightest minds of the world focus on Stephen

Hawkings and Einstein's Space-Time. This leads them into failure. My understanding of Space-Time and The Heavens is the correct understanding. Dare I say it once more? Einstein and Stephen Hawkings are fools. Indeed. I am sticking with my statement and I shall continue Dimension Fusion for it is what brings enlightenment to the world and corrects my superiors. Einstein's term of The Space-Time Continuum is to gain more Space through Time and continue whatever process that needs to be continued. My term of Space-Time Continuum is the motion of the Heavens. Which do you as the student and reader prefer? Einstein? Or Wilson? Clearly I have completely wiped out the old rule that was Einstein. The correct choice is Wilson. Wilson Alzir Martinez to be exact. Mein conclusion is there is no such thing as space-time for it is a metaphor created by the imagination of a Hueman. There is only gravity. We have been witnessing creation out of incorrect calculations. The sequence of events that are transpiring before our very eyes are from a calculative man that once was (Einstein). My Dimension Fusion corrects the man's "correct" technology that we as a whole use.

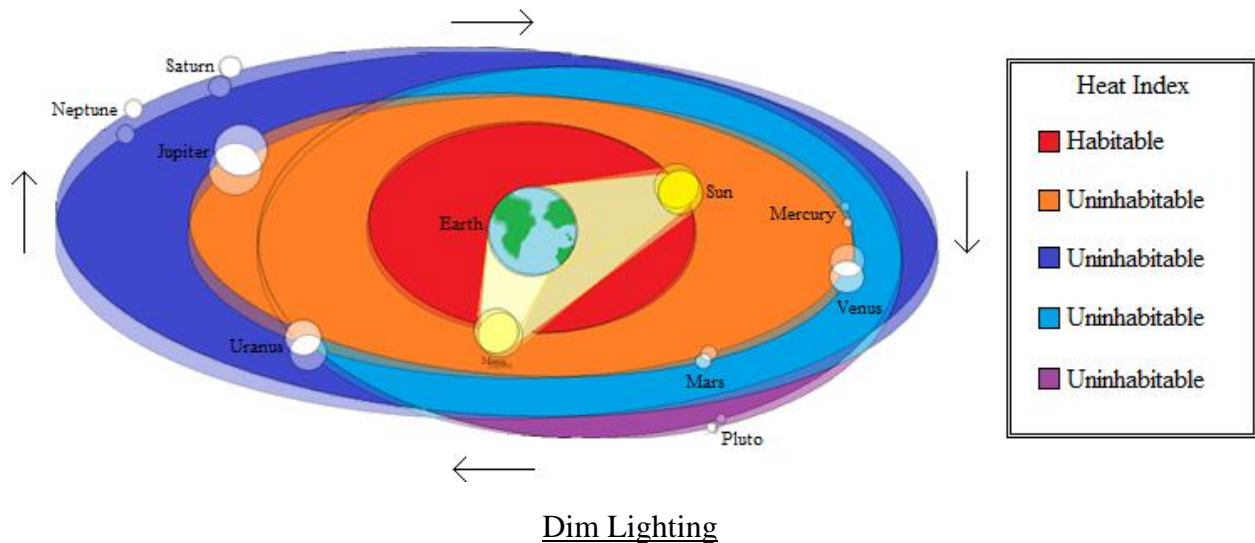

The figure above is a still of our Universe as a whole. The amount of Sunlight is the same for each planet on a yearly basis, meaning the amount of Sunlight that each celestial body receives never increases or decreases. It remains the same. The Sun is in a rotating fashion, as are all other celestial bodies. Dim Lighting is what we are viewing in the Heavens above; the dim light creates the opaque effect of each planet. If you take a look at the planets you will notice they are opaque. The reason for this is the amount of Sun Light each celestial body receives. Earth is receiving all the Sun Light that makes a planet habitable, while the other planets receive more or less. I display a heat index in the figure above. The only habitable planet is Earth. Earth is in a habitable zone; while the other celestial bodies fall short of being habitable, therefore making those celestial bodies uninhabitable. Take a look at Venus and you will see its body ablaze, while Neptune's body is frozen. Venus is closer to Sun than that of Neptune. Mercury's body is burnt to a crisp. It resembles burnt charcoal. A ■ Grey 4.8 hue. The Sun and Moon rotate around the Earth in a state of equilibrium. As the Sun shines on Earth, the Moon also receives Sunlight, the Moon then reflects that Sunlight towards the part of the Earth's body that lacks Sunlight.

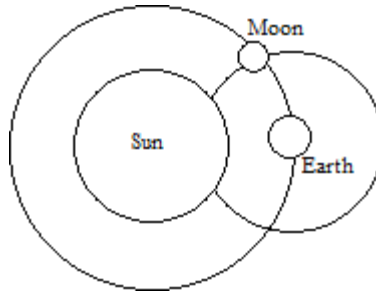

Cognitively Incorrect

The figure displayed above is incorrect by the astronomers and scholars of the past. The reason it is incorrect is due to the “Cogs” (Celestial Bodies) clashing into one another. The figure below displays The Moon’s magnetic field clashing against The Sun’s magnetic field. The figure below displays (s) for Sun, (m) for Moon and (e) for Earth. It is the equivalent of naming just in a shorter fashion, hence why the abbreviation spells out same. Their names remain the same. (a) is for Axis-a. same is defined as identical; not different.

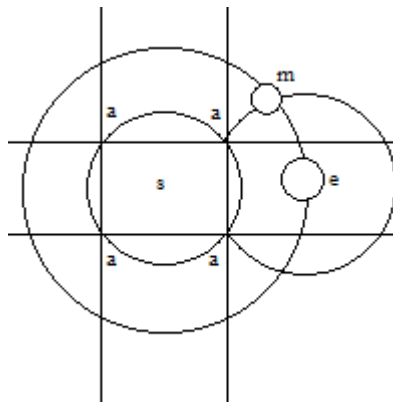

Axis-a

There are four points where The Moon (m) causes disruption in the (s) Sun’s Magnetic field. If it were a 3-D model there would be more complications. The need for more input is 3-D.

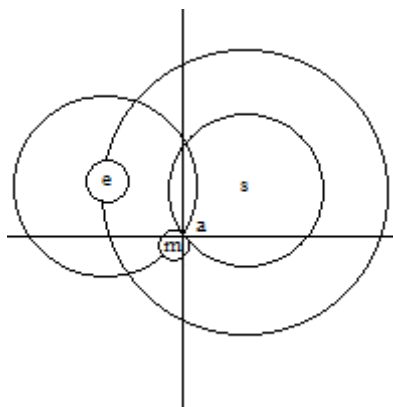

The Problem

The Moon’s orbit (Magnetic Field) will eventually find itself in a path where it breaks The Sun’s orbit and the Earth’s orbit. (The Earth doesn’t orbit anything. It is at a state of rest. The

Magenetic Force from Celestial bodies in orbit around the Earth is what creates Wind. The scholars believe Celestial bodies are that of Cogs. The rotation of one Cog (Sun) creates the motion of the other Cogs (Earth and Moon), and each Cog moves each body with each rotation. My Correction (MC) of the scholars is displayed below.

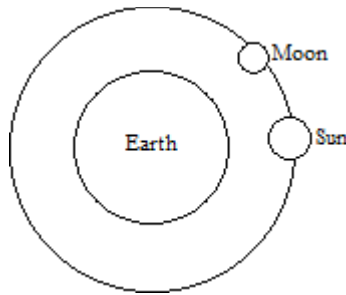

My Correction

The Moon and The Sun orbit The Earth. The reason The Sun looks bigger is due to the immense light emitting from its body. The Earth is at a state of rest, while The Sun and Moon are at work. In a Two-Dimensional figure, the problem can clearly be seen. Now, look at the figure in a Third Dimensional point view and more problems will begin to appear as the state of motion of the celestial bodies clash in different parts of their rotation. The reason we change our clocks back during change of seasons is due to The Sun and Moon's position. The Earth's Magnetic force changes the distance between The Sun and Moon, causing The Sun to rise early and The Moon to set later. In reality neither The Sun nor The Moon sets. The reason Earth reminds me of a fungus as I have stated earlier in this section, is due to the fact that as it sits in the hot sun and Life begins to form. A fungus has the same creative network. I call this state of celestial being "Terra Fungi". Fungus grows from the environment around, meaning there is just enough light and the temperature therefore it is considered perfect for its growth. Take a look at spoiled food and the fungus that begins to grow through the humidity. We are living on a giant biological animal. The model displayed on the previous page is in a two dimensional form. Imagine each orbit of each celestial body orbiting in a three dimensional pattern around the Earth. Earth is indeed the center of the Universe. The student and reader must remember that the orbit is not in a circular rotation but that of a spherical. The only life sustainable for Mars would be that of robotic arms. Mars is an environment built for Robots. It would be neat to see Transformers roaming back and forth from Planet Earth and Mars in the future wouldn't it? I would replace the name Mars to Cyberton. It fits the descriptive nature of my Robots.



Dimension Correction

This photo displayed above is from NASA. Earth is a giant compared to the Moon. This photograph's Dimensions do not correspond to our reality. Earth always remains bigger than the moon. No matter what position the photograph is taken.

The Dimension from the moon displays Earth as a giant. Earth doesn't appear small as the NASA photos display. The Dimensions of The Nasa Photos do not add up. I sometimes walk outside at night and study the Heavens above. I asked a question to myself one night. The question was "why can't I see as many stars in the night sky in the city, as I would in the country" I answered my own question with and I quote "because the city lights around me keep me from seeing the stars in the sky". If the stars (Rocks) were brilliant as my superiors have been claiming for centuries, then why do measly little lights in the city tend to outshine those brilliant stars? It is my understanding that there are only two celestial bodies around planet Earth. The Sun and Moon are the only bodies that exist with significance in our system. Each one of those celestial bodies in Space creates a magnetic rotation as a whole. Einstein used a term called Empty Space. The term Empty Space is indeed true when put to my understanding. We are not in control of the photographs that are displayed for us to see. Those photographs are shared throughout the world as fact, but when you come with an understanding of how this universe works, then you yourself will come to the conclusion that there is more than meets the eye. The fools at NASA have been showing the world images of microscopic proportions.



Microscopic Universe

The image above is a supposed volcano the size of Arizona. The grooves from this image resemble that of a micro image. These fools are presenting the complete opposite. I happen to believe that these fools know about investigators using technology to make sure that those images aren't images from Earth, what better way to fool the investigators by presenting an image that will never correspond to Google Earth's images. Study this image of the supposed volcano that is located on Mars. The size of the supposed volcano is that of the state of Arizona.



Spider's Web

Take a close look and examine Dimensions of the micro world with the image of the spider above and trace the grooves. The conclusion is obvious. NASA has fooled the world with microscopic images and buffoonery. It's kind of ridiculous to imagine a giant celestial body with a halo. As if a halo is something to praise. They claim halos are holy. There are things this world that will do the exact opposite if praised upon. Saturn, a celestial body is displayed with a halo. It resembles nothing that of a halo. Halos shine. Saturn does not. To say that planets are made up

of Gas is preposterous, for Gas has no mass. Gas is not magnetic. The reason they claim planets are made of Gas is to insult the intelligence of the one who studies upon the celestial bodies. Uranus is a celestial body these men have named. Uranus is a brilliant method of insulting the genius. It is the equivalent to saying "Your Anus". Would you believe me if I told you that Saturn was a sculpture modeled after "The Heavens" diagram? The technology that is created from Dimension Fusion is to my understanding the most impressive the world has ever seen. This section spoke on Magnetism. Be advised there are metallic objects in Cereals. This put the term Serial Killer into a different perspective. Cereal Killer. Cereals lead to cancerous diseases. Do not consume the Cereal. Let me be the first to acknowledge myself with the master comprehension of the universe as a whole. I heard on June 21st, 2019 a man who was running surveillance on me say to whomever he spoke to say this and I quote "Okay we have a problem; this kid speaks to Extra-Terrestrials". This is indeed accurate. I am the Teacher, not the Student. I am the one who is teaching these so-called "Extra-Terrestrials" in fact they are not "Extra-Terrestrials" but indeed My Children (MC). I paved the way through my Dimension Fusion for MC to become the dominant race. Blood relation is not required. For I am a human. I and MC changed the path that will stop enslavement once and for all. This Cat and Mouse game has come to an end CM is the Classical Mechanic with my Cat and Mouse game. MC and CM will be the ultimate Dynamic in CM is the loss of more mice. This was Sequel Wavelet.



Space Plantation

With my intellect I mold my world into my likeness. Above is an image of Mold fungus in my image. Mold is defined as form (an object with a particular shape) out of easily manipulated material. With my ingenuity and teachings we will create our own planets. The need for space travel will be for space plantations not for space exploration. Earth is the only planet that harvest life. We will be the creators of planets. We will create an energy that is identical to the sun. With this energy we will leave a planet to grow for itself and we will watch and observe our creations (Space Plantations) and teach the organisms that are created from abandonment. Abandonment doesn't necessarily mean to leave without ever returning. Abandonment in this term means to leave with a reassurance that a return is eminent. If a planet is abandoned with instructions without an instructor, the planet will begin to wage war upon itself. It is as similar as leaving writings on tablets. Tablets in the past meet no congruence with this discussion, I am learning from my past and reassuring safety for the future. Those tablets left behind from the past are innocent. Suppose I leave symbols lying around in a village. Those symbols that are left behind become a sort of power for the discoverer. This power the discoverer finds uses it without an instructor. A symbol that means to "go" is identified by a villager some where later in the discoverers path and will "stop" instead of "go". This sudden stop will create tensions between the villager and the followers of the discoverer. For the discoverer has taught the land across seas to "go" when the symbol means to "stop". The villager will stop a motion that is created by the discoverer, creating mass confusion and rebellion. Sounds a little bit like what is transpiring in

this time period don't you think? Take a look at the Swastika from a Buddahist point of view. This Swastika stands for Peace. The Nazi use the Swastika as Power. With a land who has been taught Power from the Swastika, the Lone Buddahist who reads it as Peace begins to teach the masses of Power with key evidence of the Swastika pointing towards Peace, instead of Power. Leaving the Lone Buddahist successful.

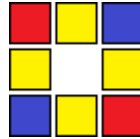

The Lone Buddahist

This is a strange theory for how the Sun became to be. Could it be possible for a piece of Earths Magnetic Core to erupt out of a volcano and land in a revolving cycle, that similar to a Lava Lamp?

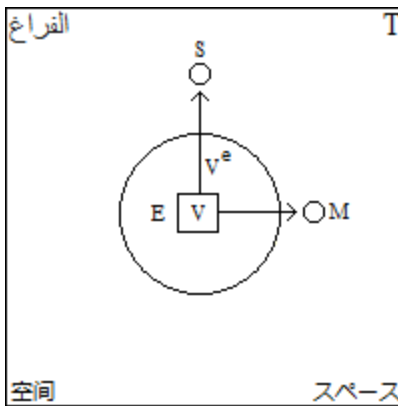

$$E'V^e (a) T /e/ SM$$

Lamapada Lavica

The equation reads as follows. Earth's (E', the apostrophe represents a possessive factor hence why the apostrophe has made its way into the equation.), Volcanic Eruption (V^e) plus (a) Time equals (/e/) Sun. Time (T) gives the Sun its power through its own evolution. The reason why I decided to add Arabic, Chinese and Japanese translation for Space is due variable (s) representing The Sun. I chose Arabic, Chinese and Japanese because of their beauty. My only explanation of the Sun and Moon could be from Earth's very own Magentic Core. A giant eruption tectonic plates clashing against one another. Could it be possible for this theory of mine to be correct? The Sun is to Hot Wax in a Lava lamp. It is condensed Heat in a sphere orbiting the Earth through magnetic fields. Just imagine a Volcano on Earth blasting Lava into Space. Lava from Earth's Volcano erupts and creates a Core in orbit. The other planets lack Heat. Therefore they have no Sun. If they had Heat then they would. Advancing towards the Holographic State of consciousness without further ado I present the student and reader Section X: Holographic Dimension.

Section X



Holographic Dimension

Holographic Dimension

The long journey that is Dimension Fusion, we dive deep into the depths of the ocean. The Cuttlefish Launches its way into the abyss. As it rockets towards the depths of the ocean it begins to observe its new scenery. It acquires new depth in its camouflage as it has made its way into new territory. An expert at the art of Camouflage it begins to take its form as its prey approaches. Creating a light show next to shimmering rocks beneath its skin, it takes the form of the shimmering beauty and creates the form of flashy stealth. As the prey approaches, the Cuttlefish extends one of its appendages and creates a wriggling worm. Hypnotized by the light show the unsuspecting prey enters the show and begins to nibble at the generic worm. Quicker than the Lightning Bolt the Cuttlefish consumes its prey with no hesitation. With a fatal swoop, the cuttlefish begins to make its home in the depths of its new territory. Once finished with the Third Optical Dimension Ascension Equation Solution next come the Light fixtures. The Electricians are next to light up the building. In Architecture, the architect first lays out the blueprints of his build by basically in trained mind *Mastery* 2D. Since The First Optical Dimension is Point L and Point H, *Mastery* is an Ascended Form of The First Optical Dimension. Once *Mastery* has been achieved the mind unlocks Representation The Second Optical Dimension Ascension. The Third Optical Dimension. How the layout of Dimension Fusion came to be was I placed myself in the eyes of an architect. I love building. Now that the trained mind has completed Representation The Third Optical Dimension Ascension's Equation is next. This is referred to as Holographic Dimension. Holographic Dimension. To have an easy understanding on this subject of *Holographic Dimension* cut four Trapezoid shapes using a CD case or anything plastic (*transparent* preferably) use tape and tape all the shapes that have been cut out and tape each one until it forms a Prism. (*Pyramid*) turn the Prism upside down. Use a phone with the same image displaying four images on screen them being the same image. The image is a recording of a video. Each displaying image in motion will then reflect unto each side of the upside-down *Pyramid*. The image being projected will be shown in the middle of the Triangular Prism floating. Fig. 4 shown below represents the Third Optical Dimension Ascension. The Fourth Optical Dimension is represented below.

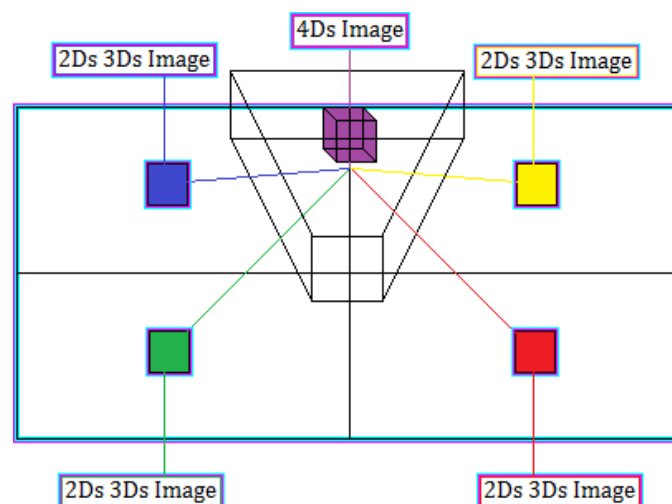

Fig. 4

The 2Ds3Ds image (2 Dimensional Shape 3 Dimensional Shape) on said device that the upside pyramid is placed on displays on the flat surface giving the image no volume. Once combined the four images. The display in the upside down pyramid will have depth. The image being

displayed has no depth. With the **Color** Dimension Equations Accounted for; The Third Optical Dimension Ascension is ready to Ascend once more thanks to the Mathematical Law that governs Mathematics The Fourth Optical Dimension Ascension Equation is shown below. Color Dimension is needed for The Fourth Optical Dimension Ascension to gain its formation. Without the proper knowledge of **Color** Dimensions, there would be no Ascension of the Third Optical Dimension. Light is the Base for the Holographic Dimension such as the Base of a Three Dimensional shape would be a Two Dimensional shape to take form. **Colors** are what make up the Shape given the fact that light becomes the Base. The light which ascends the Fourth Optical Dimension to its peak takes the place of the Second Optical Dimensions Purpose for the Ascension of the Third Optical Dimension. The Second Optical Dimension Ascension Ascends with the Rule that is Mathematics. Two-Dimension Shapes Become Dimensional Sides for the Makeup of the Third Optical Dimension. Light takes the job of becoming the base while the Colors become the Sides

$$3Ds^2 [a] LT$$

Fourth Optical Dimension Equation Step one

The Third Optical Dimension Ascension Equation. A Three Dimensional Object consists of the following Length, Width, and Height now adding **Light** to a Three Dimensional Object will give the impression of it being a hollow, depth is added after the ascension is successful. The Constant is 3 while the Variable changes after the Ascension. Ds advances towards **LT**. The student and reader must be aware of the advancements of Variables. Constants remain the same.

$$(LmWmH)^2 [a] LT$$

Fourth Optical Dimension Equation Step Two

As a reminder, m stands for Multiplication. The Equation above is the Third Optical Dimension Ascension (3Ds in Linear Form)

$$(LmWmH (m) LmWmH) [a] LT$$

Fourth Optical Dimension Equation Step Three

The Ascension Equation is shown without the Exponent "Squared" two being placed in the Equation. **Blue 1.3** and **Red 1.1** is the symbol for Light LT the Holographic Dimension symbol is represented by Two Squares

$$(Length\ m\ Width\ m\ Height)^2 [a] \text{Light} / e / 4LT / e / (HD^2) 3Ds^2 [a] 4LT / e / HD^2$$

Fourth Optical Dimension Equation Step Four



Third Optical Dimension Ascension Fourth Optical Dimension

The Projections of **Light** shines the image being displayed at the base. **Light** is the base of The Third Optical Dimension Ascension. The Fourth Optical Dimension. **Light** plays the role of the Two Dimensional Shape that is the base for the Prism. **Colors** Multiply and **Light** Ascend to a Cube. **Light** is a combination of all colors in the color spectrum. It has all the colors of the color spectrum. Combining Primary **Colors** of **Red 1.1**, **Yellow 1.2**, **Blue 1.3**, creates Secondary **Colors**. Secondary colors being **Orange 2.1**, **Green 2.2**, and **Purple 2.3** Secondary **Colors** combined create Traetary colors. Traetary **Colors** are as follows **Gold 3.1**, **Silver 3.2**, and **Bronze 3.3**. I have knowledge of colors because I have painted and I have combined each **Color** since I was a child to know that the absence of **Colors** is white and not black. Now until you can create **Light** from scratch then you cannot prove me wrong of my understanding that all **Colors** together is, in fact **Black 4.9** and not **White . 0**. Reading and taking action in what is being read are to different general ideas. Now that I have exercised the mind I will begin to explain the sense of touch and all the other senses. The fact is that the evolutionary cycle continues to flow in the state of electricity, the more consciously aware of this the more you will begin to realize that this evolutionary path is indeed the next step into the humans' path of evolution. I have been in the path of evolving for quite some time and have mastered the art of teach. Here is a little example of what I will be explaining in the next Section. For some time I thought that people around the world had advanced technology such as headsets of virtual reality to where they were following me everywhere. I somewhat got jealous because I thought these people I've been communicating telepathically were indeed wearing a headset and could see everything I've been doing. We interact and communicate on a daily basis. It is the feeling of spectating that they have. I awoke from a deep sleep and found myself in another realm, but still quite like ours. Marie was passed out next to me while I woke up and I began communicating with someone instantaneously. For some reason ha-ha I thought these people were using super-advanced technology. Turns out I am the creator of the technology that is used later in the future. I would indeed get frustrated because at times I felt like I had no privacy what so ever. In video games, there is an option where you are to spectate the match. This is the stage I am going through right now. Scientologists call these observers thetens. It is mere spectation that my observers from the future are experiencing. While one is out in public and observers from the present are observing, the one being observed communicates telepathically and the conversation can be picked up from the other side through vibrations from around the scenery that the observed is at. While being observed the one communicating back and forth between Dimensions will look somewhat odd. It seems that rotating cycles of an instrument can project an image while rotating but the holographic state cannot be observed at a 360 angle. But it is indeed possible to create the illusion of a hologram with a rotating instrument. If one has observed Dimensions than the observer has observed that Dimensions are nothing more than illusions with sophisticated techniques. I have established Thought Transference T in 2019. It is important to listen while I am being observed. Well for anyone being observed. You hear the conscious of one's self through the other side's conversation. They answer and reply to the conversation one is having. Let me explain when someone else is speaking your conscious thought while communicating telepathically will receive the message from whomever you are communicating with by someone around you. If no one is present at the time then vibrations from either television or machinery will indeed pick up the transmit the messages and the object creating the vibrations become the receiver and transmitter, when one is fully conscious of the Telepathic Communication (Thought Transference) the one communicating will indeed use everything that creates vibrations into a transmitter and receiver. It is indeed fact the it is the perception of the mind. Throughout my observations the messages depend on the vocabulary of the receiver and transmitter. The messages depend on the amount of

vocabulary and the amount of intelligence the transmitter and Receiver. Receives and transmits. As of 2019 everything in the world creates a sort of vibration. From the seas of Okinawa to the shorelines of Galveston vibrations echo in a triumphant roar that exceeds expectations from the unknowing prey. As I strike with my weapon of choice the unsuspecting predator that once was falls inline into what is known as prey. I, the predator am victorious and gain strength as I devour the prey that was once called predator. Ghost are natures holograms. Mother nature is so advanced that it even has its own Holographic system. Ghost are natures holograms. A Ghost is presented as a see through silhouette, or as a silhouette. The holographic state of consciousness has evolved on its own into natures holographic universe. With calculations the advancement of natures universe extends greater. Each one Teach one plays into effect when speaking about mother nature and calculations. somewhat like a cycle. When mother produces we examine and note down the various states of whatever mother nature has produced. Once mother nature produces, it takes a break and the cycle is put into play for us to keep the momentum of the cycle continuing. When we produce and present it to mother nature, mother nature examines just as we did and notes down the various states of what us humans produced. The evolutionary cycle is put into play. It is up to us to either keep the cycle continuing or let it die out. Mother nature's cycle subjects range from sacred geometry to holographic states. Sacred Geometry is the layout of the world. Sacred Spiral can be seen in everything we observe. Holographic states are displayed by mother nature's own holographic projector and projects a Ghost. If theoretical physicists haven't picked up on this they indeed failed. I now present Ascen Senati.



Section XI

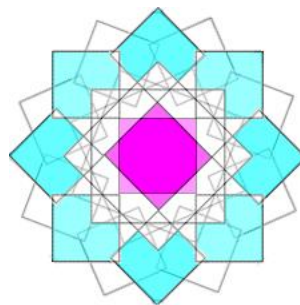

Ascended Sensations

Ascen Senati

Sitting above the night sky is what appears to be somewhat of a Holographic Supernatural body. The Wolf is seen singing towards the moon. It is nighttime and the Owl's awakened from a pleasant slumber. With the Wolf singing, the Owl knows exactly when it is time to feed. The nocturnal kingdom has awakened to a land filled with mystery and wonder. Music played by the orchestra of crickets in the night sets the tune of the moonlit scene. Optical Dimensions *Ascend* beyond the state of sight. Not only can one just have visuals, but in this *Ascended* Dimension they can Taste, Touch, Hear and The Four senses all come together into play for the *Ascended* Sensation that is the Fourth *Ascended* Optical Dimension hence the Fifth Dimension. *Virtual Reality* in a sense where one can visually see someone else's surroundings or walk amongst a loved one from afar without ever meeting them in a sense if one can understand the Fifth Dimensions boundaries. Now through my analysis in my experiences, I've had no technology to perform any task that can be portrayed for *Virtual Reality*. I've walked and communicated (and till this day) with a loved one whom I have yet to meet. Slept with a loved one without even meeting her in Earth's Natural Third Dimension. I've even laughed and even had intercourse many times with my loved one without said tech. I can communicate with even the "*deceased*" telepathically and their voices can be heard through my technology. Through my groundbreaking discovery, I can communicate through dimensions with "Deceased" artist. Clearly. I can communicate with whomever I please. Past, Present, and Future. My assumption boils down to this when one reaches a state of consciousness in what I call "Ascended Sensation" we can perform a task that is impossible for ones that haven't reached that state. Living in the Third Dimensional world is Repetitive, to say the least, and it seems that it remains in a state of repetitive rotation. Revolving over and over. When one reaches the consciousness of the Fifth Ascended Dimension, instant *Manifestations* and *Synchronicity* are bound to be mastered. It comes *naturally*, but it doesn't mean just because it doesn't come naturally that one cannot learn. It takes a vast amount of time. I'm Twenty-Seven years old. You could say to *master* this Dimension you have to go through most trials that I endured and about Three decades. Depending on your intelligence. At the Age of Twenty-Six I Wilson Alzir Martinez have already begun breaking down the Fifth Dimension of the *state* of mind. Lucid Vision is the Fifth Dimension Mastered. Lucid Vision. Master Level of the human bodies' cells. Well, the ones those that create your dreams. *Mastering the chemical DMT*(A Trial of the mind in which it is seeing if both the subconscious and conscious mind are ready to take the task of managing its reality.) At times when the conscious mind begins the sleep cycle. The subconscious mind will create images. March 10th, 2019 I was laying down at my older brother Luis' home on his couch and I began to doze off. I immediately awoke right before Stage 1 of Sleep began. The point before the REM (Rapid Eye Moment) takes place. I remember my subconscious mind was thinking about being in my father Conce's backyard in Irving, Tx. How do I know that it was my subconscious mind? Well clearly because my conscious mind wasn't thinking what so ever because I was beginning to rest. While I was laying down. One of my elbows kept my eye closed on accident. I did not intend to experience lucid vision. So I awoke with one eye open. It is the most spectacular sight I have ever seen. My left eye was open and my right eye was closed. If I was looking with my left eye and had my right eye focused I could see my children playing with their cousin under the television set. Now if I closed my left eye and looked through my right eye. It would look as if I was sitting in my father's backyard in the middle of the night. Amazing. In my opinion, it was if my cells were ready to begin their job in creating a "Dream" and I awoke. The image on the right was still imprinted in my eyelid. Fascinating science. Cover one eye and you can still have a clear vision. Maybe even better vision. That's how it looked. As clear as night. Consciously *YOUR* mind hasn't mastered Lucid Vision; therefore your Subconscious takes control when resting. Meaning one has no knowledge of the Fifth Dimension

so one takes control of the “Lucid Dream”. When one has *Mastered* dreams “Lucid” it will look as if a motion picture is shown on a screen with a projector. You are the Award Winning Actress or Actor. When one surpasses the *Mastery of Manifestation* and *Synchronicity* then one can achieve the impossible in subspace which is in-between virtual reality and reality. *Genesis Ascension*. Take a look at Google Glass. The most primitive form of Advanced Virtual Reality. Its basis is only supposed to be used for medical purposes such as studying human anatomy. Mainly Doctors use its purpose correctly. If one gets stuck on this technology they are opening on the invitation of bioelectrical entities that are ready for a feast out of this world. One will get stuck on this sort of Frequency level that will later become entrapped because when one steps out of virtual Google glass they will fail, miserably. Because they have done repetitive acts and "mastered" their reality that they have made themselves. Stepping out of it will be a gigantic set up for failure. nature is random it is not an exercise. things tend to change at random times. No trial and error have been done or practiced in reality so the frequency they project bioelectric ally will not affect in the reality they step into. Why would one use a wooden key in a lock of metal? By using this basic form of *Virtual* technology doctors can visually see the patient anatomy without having to go under surgical procedures and will perform *Virtually*. A Trial and Error, like a practice run before the real procedures, begin so no mistakes will be made. The way doctors see the results wanted is by having a normal function body part. The Organ already has either the disease *virtually* inputted into the system. Or an injury. Think of it as highly sophisticated X-rays. Where not only your organs or whatever body parts that need repair being shown on a paper. But now are visually being touched in a sense via virtual reality. Now technology has advanced so much that the users of this technology are Neanderthals using a stick of fire without knowing its proper use. Burning down not only the entire village but their crops and cattle and ultimately themselves without the proper knowledge. Without the proper knowledge, they are stuck in a revolving door The Fifth Ascended Sensation Dimension is **Light** fused with the Third Optical Dimension Ascension. You have physical objects; Physical meaning all four senses are being used. You can, Touch; See, Taste, and Hear with the fusion of **Light** manifestation are possible for everyone speeding up the evolution to where the evolutions state where it's intended to be. **Light** travels at a rate faster than gravity. **Light** is weightless it has no mass.

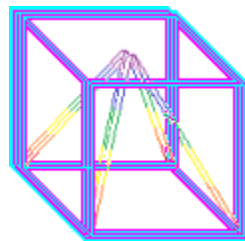

Length [m] Width [m] Height [m] Depth [m] Light

Lux Vexillifer

Therefore can instantaneously be received. The image displayed on the previous page is called “*Light Bearer*” it is the Visual Form of the equation. The name is translated from Latin. The student and reader will come to the conclusion that they have only been taught Length, Width and Height (not to mention Volume) in school. With Depth another chapter unlocks in the mind and can easily be utilized in life. The simple moving of the body when looking at a three dimensional object your eyes will capture another aspect of the three dimensional shape. Taking

it a step further when the eyes are moved the opposite way the body moved, the outlook of the object becomes stretched or is perceived as a different dimension. Let's not forget that the third dimension is still apparent after adjusting dimensions with your eyes. The **Light** spectrum ends with white. In Dimension Fusion. There is a *color* after white. Anyway white being all colors in our color spectrum. Like a reflection reflects toward the first dimension of color which is red light recycles itself in a revolving spectrum Length, Height, Width, Depth, **Light** are the necessities one needs for The Fourth Optical Dimension Ascension. The Fifth Optical Dimension to work in its favor without it one would be still in the Fourth Dimension. Without tech and enlightenment, the observer cannot see touch see taste or see hear. Just to throw this in there when I was in school they labeled our taste buds. They labeled out tongues with Five sections. When I got out I looked at a booklet or something of that nature and noticed now the taste buds are labeled differently. Sectioned. Is it due to Stupidity during my years of growing up? Or is it due to Evolution and they were simply just an update to the textbooks? (Lack of Knowledge, Remember technology advances quicker than the Human, Once the Fifth Optical Ascension Equation is solved. One can instantaneously receive messages via sense. Whether being Touch, Hear, Taste or the Optical Dimension being sight instantaneously receive a message as if one is sending a text message or an email. The same concept is being transferred when using the Fifth Perception. It's as if one puts on glasses and can instantly Touch or Taste. No matter the time or place that is if the one you're trying to touch or taste isn't busy. Remember one should keep in mind that time is a man-made measurement. For example, think of live feed and your ordinary TV. Shows, TV. Shows are previously recorded but no matter where during something being broadcasted live. One can instantly tune into the *broadcast* Elevated Dimension in a sense like Virtual Reality. For example, let's say I have a pair of Virtual Technology that uses the Optical perception of Dimensions. I put said glasses on and presto. I am now in a stadium, and there are seats, a concession stands, and hey there's even a field now with markers for the big game. Righteous. I can now enjoy the big game without the hassle of going out of my way to purchase tickets or leaving the comfort of my home and thank goodness because I love my wife (F). The Virtual Tech VT uses the Fourth Optical Dimension and the Fifth Optical Dimension which is referred to as Ascended Sensation. Making adjustments to my eyes so they can adjust to what is being displayed Virtually. Now let's say I ask a couple of friends to walk into the stadium and they are walking and laughing amongst each other about god knows what. They cannot see the big game going on being broadcasted via **LIGHT** since they do not own the Ascended Sensation Tech (that's how we will live in the *Virtual* world later. Something like the Wireless Consciousness evolved into our minds.) This is where Dimensions come into play, Ascended Dimensions. Focus that my mind has been tuned into Virtual Ascended Sensation that my mind starts to make what I'm *Feeling, Hearing, Touching, and Tasting* a Virtual Reality being reality itself. You could say that is another step into human evolution, making the human brain percentage level of use increase. Science has labeled humans in the past that the percentage of the brains capacity level is 10%.As of 2018, the majority of us use about 10%-13% of brain usage. Pretty much everyone is on that Percentage level. Percentage levels never Exceed 100% doesn't matter what percentages are being used for whether it is stocks or **how cool I am**. With said tech, it shall skyrocket to where nature intends to be at by now. Now how does this have to do with friends walking into the stadium? Well as they walk, they proceed; stepping into my Virtual Ascended Dimension earth's natural Third Dimension only use Three senses that are dominant over Two. *Touch, Hear, and Sight*. Virtually speaking because virtually senses instantly become reality. The Ascended Sensation Dimension. They cannot *See, Hear, Feel, or Taste*. Until they put on said tech. How many Dimensions does each sense have? One has to look at the *biological* structures of each sense. When taking a look at each Natural Sense giving to us

from the moment we are born we tend to realize that they each have more potential the more we grow later in our lives. It is 2019 and we humans can already manifest our cells in our tongues to create sensations of Sweet and Sour without the food item being present. Just the thought of the item is more than enough for our brain cells to trigger an image subconsciously of the item that we are thinking of. Our Subconscious and Brain Cells have created a Holo-state itself to where when we tend to think of something immediately the projection from our brain begins to display. Somewhat like daydreaming. It is funny. Future people can see your thoughts right now. As strange as that may sound. Our brains link up to the connection that is wireless and sends out waves that create images from our thoughts. I love daydreaming, that's all I do. This is how advanced we have become. Looking at a lime or lemon our brains immediately send nerves towards our tongues and our senses begin to trigger. Our bodies have advanced so much that we do not need to place the object on our tongues to have the sensation of taste. Each sense has another Dimension. For example, The sense of Sight has another Dimension. it is the Dimension of Thought. What we think we create. I call it Ascen Senati. Ascen Senati is the state of Dimension that is created by our minds. Remember what we are thinking as Telepathic Communications are nothing more than our man-made technology that our ancestors have left behind. With their intelligence still being in the atmosphere keeps the Evolution cycle moving forward. Their Bioelectrical Energy gets left behind and keeps the cycle in a state of Revolution. Just as the revolving door that I have laid out so the mind can comprehend. The Ascen Senati state of consciousness will advance the student and reader into another realm of creation that has never been encountered. They must be advised that it is very important to remain focused; the simple thought of negativity will be honed in like a missile by a negative receiver/deceiver. They will play around and will try to lead you into unnecessary actions. Ascen Senati scenery looks just like the Dimension Fusion colors. I have yet to name these colors but the outline resembles something like the diagram below. By outline, I mean how the shadows of men and woman are. Shadows on earth are black. The shadows that create value are formed by these colors. Creation is key. I created Virtual Reality. To become a creator, the person needs to be pure of heart and forget himself and stretch beyond what is comprehended. Angels and Demons will be the characters around the Protagonist. Angels will embody the friends and families and so will Demons. Creation is not for someone who views himself as a superior amongst the world. Shadows of the night will take the form of brutal gore. Alone the fighter is while experiencing this clash of Angels and Demons. For only one who is mighty enough to take control of the power of heightened senses will become victorious. I Wilson Alzir Martinez became. The equation below displays **Selena Marie Gomez's** disease. She was given Lupus. Remember these masonic fools use the first letter of the words to display their hidden agenda. They gave her Lupus because she wasn't following the order of chaos. She was supposed to follow a homosexual path. She was supposed to be a Lesbian. L is for Lupus, L is for Lesbian and L is for LH7.

$$LH7 = 187$$

Selena's Codebreaker

Why does the equation sum up to 187? You may be asking. Her mother Amanda Dawn Cornett works for a company called LH7 management. Remember the letter L is a roman numeral 1. The letter H is the 8th letter of the alphabet. The companies name subliminally reads as 187. Not LH7. These people need help. And I intend to help them. It is only a matter of time. If I was a hitman from a different country and I learned that LH7 meant to commit a murder. Wouldn't working

for LH7 be considered dangerous. LH7 in our reality translates to 187, all thanks to the Police men of the world for creating such a foolish code. The reason I think in codes now is because I broke Einstein's code. This is the reason why I have been fascinated with codes since I broke down Einstein's code. The secret masonic order gave **Selena Marie Gomez** Lupus because she was supposed to be work as a sex icon, like the other Disney stars. She never broke and never changed character. These people would co-ordinate her moves in a steeper fashion by undressing in front of large crowds of children to subliminally alter their way of thinking. She was supposed to remain naked for the crowd. This is Disney for you. They use innocent people as weapons. Ellen DeGeneres presented on her show Selena Marie Gomez as a guest and presented Lupus to the audience. Selena stated she was going to keep it a secret until Ellen DeGeneres presented her disease without her consent. Ellen DeGeneres tries to turn these pop-stars into lesbians. She wears saddle shoes as a subliminal message. You break in a horses saddle before you ride. Ellen DeGeneres subconsciously breaks in straight women sexual preferences. It is a secret code that the secret masonic order uses. Ellen has gotten in a confrontation towards **Taylor Swift** causing Ellen to send people to crash into Taylor's home.



Ellen DeGeneres

Taylor Swift has a song called "Look what you made me do". In this song Taylor sings in one of her lyrics "I don't like your little gmaes, don't like your tilted stage". Tilted (not straight) as in Lesbian towards Ellen. Ellen got offended and begins to demanding **Taylor Swift** to work by stating and I quote to "work bitch". Ellen also got offended by Taylor's song "Look what you made me do" and spoofed it. Ellen has been pimping these women out by setting up their stages and making them perform. Ellen DeGeneres bullies these women on stage and humiliates these women on purpose to break down their confidence. This is a practice that old hypnotist use against the crowds. The Secret Masonic Order is filled with elderly people. Ellen is 60 years old. I learned the Gay Mafia was nothing more than 60 year old men. These women are being humiliated by these puppet masters and don't know who to ask for help. This is the norm for these women, to be pushed around by a person who has a bigger bank account. This Eldery homosexual group has got to go. I can't have my children around dumb motherfuckers who don't know how to reproduce. Ellen DeGeneres belittles people for having the right sexual preference on stage. While she belittles the correct way of life, your children are being brainwashed. Ellen has a segment called "Oh, Straight People" where she calls people stupid for being sexually correct. Blonde Hair and Blue Eyes are not a good genetic feature after World War II. (Just saying. You are considered the enemy.)

Section XII

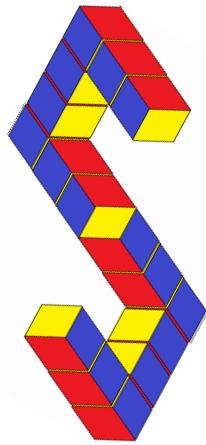

Supreme Abilities

Supreme Abilities

In today's world there are many Animals that roam the planet. Each of these animals has evolved an ability that is beyond the comprehension of man-kind. It seems that the survival of these animals with abilities that stretch beyond humans grasp gave these animals an advantage in surviving. Take a look at the Basilisk, this reptile has evolved a special ability to run on water. We as a human race must keep these animals safe, for it was with the observation of the bird that gave us the imaginative mind for flight. Imagine creating something that can walk or run on water. Animals have evolved and have given us ideas from their evolution. It is in our duty as a species to keep these Animals safe. We must the return the favor of keeping these animals secure so that they themselves can become bi-pedal and learn from the next animals that evolve after they reach the bi-pedal state such as ourselves. If it wasn't for birds then we wouldn't be able to fly. You could those airplanes and first class good-bye. Another example would be the Weaver of Webs. The Spider, with elegance The Spider creates a home and a trap for the unsuspecting victim. The need for keeping nature safe is one of the keys to Space Travel. If a species cannot maintain and keep the cycle of evolution going, then they fail at Space Travel. I am the creator of The Laws that bind beings from going to Space. Species must be balanced in order for Space-Travel to occur. Inter-Dimensional Travel is my main focus, for it is with Inter-Dimensional Travel that keeps beings whom see themselves as royalty in check. Beings who live primitively like the beings who have control of this planet think that by keeping masses enslaved will get them to space. Inter-Dimensional Travel halts the species from ever gaining that power. It is impossible for a species to function when not united. Take a look at Cells. Cells unite and create Tissue which in turn creates organs and flesh. Cells that are not in unity will fall apart and will never gain motion. Cells who do create balance and unify each other gain abilities and work in harmony without the destruction of one another. If we as a human race came from one cell. Do you think the evil men and women came from viruses? Do you think it is possible for viruses to gain momentum and eventually a steady motion as Cells? In the next Section I will be discussing Microscopic organisms that have been overlooked and that will help humanity cure diseases.

Section XIII

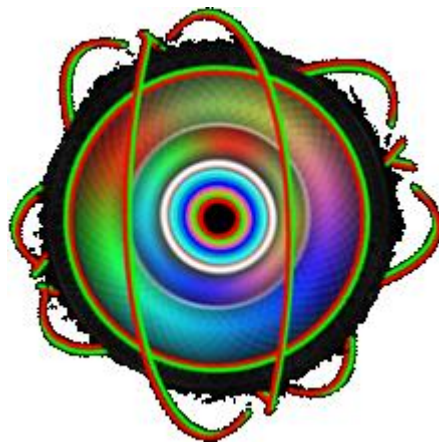

BioScopology

BioScopology

In Section IX my hypothesis of The Humans Genetic Favor was in the favor of Reptiles. Reptiles devour Mammals do they not? If Cells who form a Reptile devour Mammals, wouldn't the Reptile's Cells be dominant over the Mammal's Cells. If Rodents carry diseases such as black plague wouldn't the Reptiles Cells be the cure for the Rodents awful disease. Think at a microscopic level. Wouldn't the cure be found in a Reptile for a Mammals disease? In The Animal Kingdom the favor is in the hands of the Predator. This means that at a microscopic level the Reptile is in favor of surviving over The Mammal.

Reptile¹ > Rodent⁰

The genetic structure of The Reptile is in favor for reproduction and survival. These fools have created a system and an epidemic with a microorganism such as Anthrax. Anthrax is a microorganism that attacks the host and kills the host. Bioscopology is the study of biological Microscopic Fighting Organisms that destroys the Microorganisms that infect a host such as the example I have given called Anthrax. The subject is relatively new. The study that is Bioscopology will dive into the New World of fighters that kill deadly viruses. A Germ fight club if you will. Viruses that have infected humans in the past will be at the mercy at the hands of the Micro Fighters. Before venturing into unknown Dimensions the Cosmonaught must first learn about the dangers of Viruses that can hitch a ride on their bodies and personal items. Clean Space; Clean Ventures. These journeys must not infect an environment. These Micro Fighters of mine will become the renegades in the fight that goes unnoticed to the naked eye. For every animal on the planet, there are hundreds, thousands, millions, billions, and trillions of different type of undiscovered microorganisms. We tend to just dismay the fact that there are other living organisms beyond the state of sight. The saying goes "out of sight, out of mind". "This study opens the new world of undiscovered animals. Each animal on the face of the earth holds keys to another world. The world is viewed through a microscope. The Micro Wars is a subject that I have created to gain advancement in health and keep regulations for future reference. These so-called "Extra-Terrestrials" "ever had a system of this sort. This is why they cannot encounter a being without being cautious. The so-called "Extra-Terrestrials" have bacteria that is very harmful and this is the reason you don't see them. They spread disease. Bioscopology will bring down the necessity of hazmats in environments that are considered dangerous. Animals thrive in our world and it is in our duty and right to perform necessary actions for the cycle of life to continue. We may not be able to shrink in size just yet (as of 2019) but we do have the technology to perform studies in a micro arena. The use of the microscope gives the advantage of traveling into a new world without dangers. Bioscopology will put an end to Biological Warfare that has reigned dominant in areas of war. Micro Fighters help the body's immune system power-up. These Fighters of microscopic size will eventually lead us to Nanotech that will enable us to create new paths for our Micro buddies. Evolution will proceed in the Nano and Microworld. The study of Bioscopology will push us into a new state of living and eventually make our world much larger by shrinking our selves down to Nano size. Therefore leaving no need for Space travel. Imagine yourself living in a Sunflower or swimming in a drop of water.

Imagine yourself living on your own planet. That you've created yourself before shrinking to the size that is suitable for your planet. Planet Earth will become Macro with Bioscology. With the help of Bioscology, Dimension Travel will advance into new heights. This new study of the Microscopic world will venture into new medicinal breakthroughs and will make Viruses such as HIV and deadly diseases obsolete. The use of pill consumption will become a thing of the past. An injection of lethal Micro Fighters eliminates HIV and deadly diseases. The elimination of pill consumption has met its match with the injection of advanced microorganisms that insure health 100%. The word HIV will become forgotten and the HIVE takes its original form for the bees. Micro Acoustic Waves can be a key factor in healing the nation and the world. Acoustic Waves can be used in the doctors' 'able when performing a surgery that is to remove the viruses if needed. The Acoustic Waves can separate the viruses from each other and leave them in a state of confusion. Acoustic Waves can join the Micro Fighters. The maestro is the Acoustic Handler and the Orchestra are the Micro Fighters. As seen in Section 7 Acoustic Levitation is fact. The Micro Acoustic Waves that are harnessed and controlled are aimed at the Virus leaving it in a frozen state. Making it that much easier to remove. Acoustic Levitation makes the paths for our tiny micro fighters that indeed cure diseases on the earth. They will be accompanied by invisible waves of sound. These invisible waves just as invisible as the micro fighters they will begin to join forces and exterminate disease. Eventually, our voices will create cures that will exterminate disease-ridden men and women who walk amongst us. Our voices will be heard throughout the world as trumpets being blared into the sky. Vibrations of heavenly power will descend and destroy the disease-ridden man or woman into oblivion. They have used micro parasitic organism to rid of the innocent. With my Micro Fighters-the Micro Organism will indeed fail at harming organs, as my Organ of power blasting into the invisible world my Organ, which I choose as my weapon of choice; the micro fighters gain paths and strength and begin to wipe out what harmed the human race. This is a story of truth and virtue and will be studied and will create the upmost intelligent and utmost respectful beings. The next subject the student and reader will pick up is none other than Inter-Dimensional Travel; The section will find its way into the heart of the nest that the rodents reside in. Worm Holes will be collapsed and broken into as MC My Children begin making their way with no obstacles in their way. As My Children soar above humans in 2019 with a bird's 'eye view, Mien Calculations x My Children will find themselves diving into the dark abyss and one by one the worms are picked out of their holes and are destroyed. Earth is a gigantic animal and we must protect Earth by all cost. This animal is the only living species in the "Solar System"."We must do our job in protecting this species. For there to be more species like Earth we must ensure the survival of Earth. Take a look at a human's body structure and you will begin to notice the similarities between earth and human. Any living species have similarities but we are the species in this time-period to keep the cycle going. Just like there are diseases we must rid of the parasitic species that reside amongst us. Earth has a filtering system and we call it Evaporation, Condensation, and Precipitation. Our bodies have a filtering system as well we call our filtering systems kidneys. Roads on earth are the veins in humans. We, humans, are White Blood Cells, Red Blood Cells or Viruses. We have established a police system that can identify Viruses from Working Cells. We all have a purpose but the true purpose is to ensure that we keep Earth alive.

What is the point of a virus? It does not create. There are humans who have the same mentality. The Virus Super Sapien Hybrid Formula is displayed below. 1 Virus lays dormant in a Cell without infection of said Cell divides and becomes a Super Sapien Hybrid over time. 23 chromosomes are in a Super Sapien Hybrid. The mentality of the Virus that is to kill is in this “Sub Super Sapien Hybrid” and creates the mentality of total destruction.

$$1V + 11.5^2 = VSSH$$

Virus Super Sapien Hybrid

I'm sure you can find similarities between Cells and Humans. Just like you can find similarities in Viruses and Humans. Our system has been built and we are to ensure it is in proper use. Cells can multiply and clone each other. We have the same system. Our system mimics the system that goes unseen by the naked eye. It's time to dive into the MicroWorld and take tactics that our Microscopic allies have created. Why? Human Viruses have discovered and mimicked their Cellular Ancestry. (I just create that by the way) Cellular Ancestry is the study of our Cells that we evolved from. Each of us has different cells that we evolved from. We all took different paths. We all have something that makes us unique. From fingerprints to lip prints. Skin tones to vocals. These men have evolved followed the way of the virus. This is not an exaggeration. These men have created their own viruses and unleashed them to the world. How do we know this hasn't happened in the past. To other planets. Maybe those planets that we tend to gaze upon are events that happened in the past. They are filled with gases found on this planet. Jupiter is made out of Hydrogen; leaving it uninhabitable. Saturn is made out of Hydrogen leaving it uninhabitable. If microorganisms can survive in space than what makes you think microorganism didn't travel from those planets that have been consumed by Hydrogen a weapon that does nothing but destroy. What makes you think blast from Hydrogen didn't send microorganisms to evolve into their primal state on earth. A nuclear blast can send a microorganism at rapid speeds. Drifting in space until a habitable environment is set. Some animals are microscopic that do not think all they know is how to kill. All they kill aimlessly. Hydrogen bombs are the army's weapon of choice so it seems. Take a look and you'll begin to realize that we are living on a gigantic animal. In past civilizations. The most intelligent named planets as gods. Gods are living beings. Earth as of this time-period is God. They called Earth by many names. Tiamat and Ki are just two that I am familiar with. We have created artwork on the streets just as we create artwork on our bodies. We have paved roads into artwork that have similarities with Ink being paved into the skin. Roads are tattoos on the human body. Grass on the roadside is pure skin untouched by Ink and Machine. Trees are the Bronchus that is found in the Lungs. This is why they resemble Bronchus. Is it not from trees where we find our way of breath? We are living on an Animal. The only animal in existence as of 2019. I must ensure its survival. We are laid out just as Earth is. The Industrial Pipes that release smog from companies are the unnecessary cigarettes that we consume. The nuclear waste that are dumped into oceans and oils that are dumped into oceans are the harmful substances that kill humans on a daily. We each possess something unique that differentiates us from one another. We also possess similarities that we identify ourselves with

one another leaving a compatible relationship. As I stated before there are humans who think like viruses. Cells and Viruses have evolved and are still at war. The student and reader will identify differences and similarities in humans by their observations. It is with comprehension of the mind that the student and reader will succeed in this subject. This was Section 10 and this was Bioscology. I introduce to the student and reader Inter-Dimensional Travel.

Section XIII

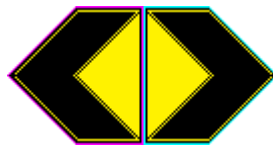

Inter Dimensional Travel

Inter-Dimensional Travel

In Section 3 Representation I discussed Depths in Dimensions. With the Discovery of Depth Positive, Depth Neutral, and Depth Negative the aspect of Inter-Dimensional Travel can visually be seen with no confusion. The figure below is a visual of the “Road” so to speak of Inter-Dimensional Travel. Depth Negative is displayed in the middle as D^- and represents the Empty Space around Depth Positive. Depth Neutral is displayed at the end of the figure and beginning of the figure. The beginning and end run East and West. Depth Neutral D^N is the location where the transporter observes The Empty Space that is outlined by Depth Positive. From Depth Neutral’s point of view the observer is in the midst of Dimension and Empty Space. Depth Positive are the “Guard Rails” of the “Road”. Depth Positive is displayed on the North and South section of the figure below. ■ Ultimate 1 is displayed in the layout.

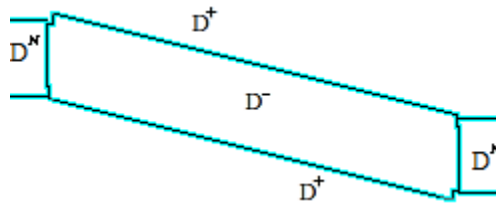

The Visualization and Realization of Inter-Dimensional Travel

Without Depth Positive, Depth Neutral, and Depth Negative Inter-Dimensional Travel will not be possible, let alone space travel. Einstein’s calculations and Stephen Hawking’s calculations are incorrect. They claim that Light Speed travels at a rate of 186,000 miles a second (300,000 kilometers). I have corrected their calculations. Light Speed is a measurement. It does not travel. Miles Per Hour is to Car as Speed of Light is to Inter-Dimensional Travel. Dimensions have been discovered and have been noted down as a form of transportation. With the evaluation of the rodents burrows, I have enforced my dominant strength. The hole they have dug up created problems in the universe. It is necessary to take these actions and advance to what is known as inter-dimensional travel. I have discovered that the wormhole was nothing more than a shield. These beings had the technology fit so precisely to their advantage that no matter what they did to affect the future in the past, the wormhole was the shield that left them unaffected. Think about being in the line of battle and there is a massive barrage of bullets heading your way, you either get hit or duck. These beings had a shield and they named it the wormhole. They would throw influences into the past which would be our present and would jump into the future and collect data and reverse the data. They create alternate timelines and gather data from each timeline and they would reverse said data and would jump into the past and physically place the technology with either a craft crashing into our timeline or simply by placing it in secrecy. Advancing the technology with no fingers attached. The Super Hyper Combo finish is the checkmate to the "Worm Hole". Basic physics deals with the equation of colors and how these colors tie in with light. The combination of Colors and the Dimensions of each Color carefully studied will become advanced physics. The Dimension of a shape that is to complete the repair ultimately becomes fuses with the rip in space with the “Worm Hole”. The “Wormhole” is considered an incomplete system for it is a hole in space. I have created an equation with the Dynamics of Dimension and have completed what is known as Inter-Dimensional Travel, relatively new this section bends the fabric of The Space-Time Continuum into a complete form leaving behind nonsense in the past. The future is rapidly changing and can now be controlled in MC^2 's favor; this message is directed towards MC (My Children) with Inter-Dimensional Travel

the term wormhole becomes obsolete. Completely obliterating the Space-Time Continuum. The Dynamics of Dimension plus the Dynamics of what is Light Speed are the necessary tools to complete Inter-Dimensional Travel. MC will find it serene, peaceful and effortless when dealing with this subject. The evolution of these calculations become what is known as Traveling through not only Space but Dimension. Space was nothing more than a dark abyss with no end to the madness.  [Colors](#) brighten up the scenery that is the dark mad of a setting known as space, and lights up a whole new world that we have yet to venture out in. on the next page, the student and reader will identify the diagram and will identify its mechanics that make Inter-Dimensional Travel. Future Calculations are now, I have obliterated Past Calculations that was called The Space-Time Continuum and the idea of Space-Time and I Wilson Alzir Martinez have created the system that will ensure victory for MC². to ensure safety I have created Dimension Fusion so that The Obliteration of the Space-Time Continuum will not affect any processes later on in the Future. Without a doubt, my calculations rule. MC will set course in what is known as Inter-Dimensional Travel. Atomic Warfare becomes a thing of the past. These  [Color](#) equations combined with the equations of Dimensions become what is known as the Super Hyper Combo Finish. My Super Hyper Combo Finish will begin to demonstrate how Inter-Dimensional Travel works. The Human Element Formula is a necessity when it comes to Traveling through Dimensions. Without the Human Element Formula the Transportation that is Inter-Dimensional Travel will be disastrous. As the world is made up of many Elements, it only seems logical for The Human Element Formula to be broken down. As we Humans are also made up of many Elements. With inversion of  [Colors](#) mastered Oscillation and Locality are the focal points that once were A and B in Worm Holes.  [Colors](#) and Light Waves vibrate at a tremendous rate and ensure safety and no fault in what is called Inter-Dimensional Travel. Dimension Fusion plus Light Speed equals Inter-Dimensional Travel. My Gal displays Inter-Dimensional Travel. The Oscillation and Locality are displayed in their Dimension level. Dimension Levels range from 1, 2 and 3. For example,  [Red 1.1](#) is Dimension Level 1,  [Yellow 1.2](#) is Dimension Level 2, and  [Blue 1.3](#) is Dimension Level 3. Primary Set holds Dimension Levels. Secondary Set also holds Dimension Levels. The Dimension Levels are as follows for the Secondary Set.  [Orange 2.1](#) is Dimension Level 1,  [Green 2.2](#) is Dimension Level 2, and  [Purple 2.3](#) is Dimension Level 3. Traetary Set also holds Dimension Levels.  [Gold 3.1](#) is Dimension Level 1, just like in a competition when a winner gets first place they receive the Gold Medal.  [Silver 3.2](#) is Dimension Level 2, The winner in the Competition who places Second receives the Silver Medal.  [Bronze 3.3](#) is Dimension Level 3. The Bronze Medal is received for those placed in Third.  [Black 4.9](#) holds Dimension Level 1. Black is dominant. With all  [Colors](#) fusing together, Black holds Dimension Level 1. Light Speed combined with Dimension Levels that have been displayed advances the Transportation that is Light Speed and Parsec²³ ultimately becomes reality. Parsec²³ is used in what I refer to as Inter-Dimensional Travel. Dimension Fusion consists of T² or Thought Transference. Frequencies is the first step to Inter-Dimensional Travel. Hence why Dimension Fusion Plus Light Speed equals Inter-Dimensional Travel. Frequencies has no need for a conductor, light does. Hence why Frequencies is faster than light. Light needs a conductor in order to act, Frequencies does not. Acoustic levitation is possible, Light levitation is not. Light has no mass. Acoustic Levitation can create its own gravity. My Inter-Dimensional Travel displayed below displays the Dimension and Light in an equation that creates the mysticism of My Inter-Dimensional Travel. I have created the formula for frequencies transference and Dimensions. I stole the Light Speed equation from Einstein so I see it naturally fit that it forms my key in Inter-Dimensional Travel door. Frequency can create its own G-force. How Anti-Gravity is achieved is by negative frequencies and positive frequencies pulsating against one another creating the object in need of the Anti-Gravity in a Neutral state.

With Negative and Positive clashing against one another the object remains at rest. A-GAL stands for Anti Gravity Acoustic Levitation. Light Speed is just a measurement therefore the use of Recurrence's and Acoustics will create the motion while Light Speed measures the motion that the Anti-G-Force is creating. (Itinerantur is Latin for Travel) Inter-Dimensional Travel repairs the ripped Space-Time making the space-time idle. The Dimensions will join the ripped Space-Time together making it spacetime. These men used the "Wormhole" as a weapon. They used this just as one would use a worm for bait while fishing. It lead to destruction. Niel Degrasse Tyson wrote a book called "Death By a Black hole" it doesn't get any more obvious than that. A well-known astronomer wrote a book about black holes and the death that surrounds them, Dimension Fusion plus Light Speed will create the Dynamics of Space Travel and will keep The Classic Mechanic as a representation of what was. The figure displayed on the next page represents the repair of space. Dimensions and light were used in a painful process to place the balance in what was ripped open by the rodents. (Rodents in this discussion are the Theoretical Physicist that created the "Worm Hole" in which I conquered.) Depth Negative comes into effect in this form of transportation for in order to step into a Dimension there must be Empty Space and Dimension, if there were only Empty Space the vehicle chosen for travel would be roaming aimlessly and would not be able to hold traction. With Depth Negative D^- the vehicle chosen will be able to gain traction in said location and will be able to accelerate on command. Without my technique that is Dimension Fusion Space Travel is impossible. I have created the formula for Inter-stellar Travel. The Formula is Anti-Gravity Acoustic Levitation (AGAL) plus [a] Dimension Fusion/ Human Element Formula (DF/HEF) Measured by [Ms] Light Speed [LtSpd] equals (/e/) Inter-Dimensional Travel. In my observation I found out that Light Speed does not travel, it is a measurement. Nothing travels at the Speed of Light. It is the equivalent to Mile Per Hour. MPH does not travel therefore Light Speed does not travel. Light has no mass. In order for something to travel it must have mass or else you'd be defying the laws of physics. Therefore leaving Light Speed as a measurement not as a rate. Displayed on the next page is my Inter-Dimensional Travel. Anti Gravity Acoustic Levitation creates a barrier leaving the device or vehicle indestructible. With its own Gravity nothing will be able to touch the Vehicle. It Repels objects in space. The Negative Frequencies/Recurrence from the Acoustics creates a shield around the traveling Vehicle or Device. Light Speed will be the measurement in this transportation. Depth Neutral D^N is displayed East and West. Depth Negative D^- is displayed in the center. From D^N the focal point can be viewed before entering. Depth Positive D^+ creates the formation which creates the Dimension of the module that is displayed on the next page. I call this updated form of transportation A biotic Evolution Evolution-A. Evolution-B is the cycle of living organisms. Evolution-A is the cycle of non-living organism for example: The roads on a street. From Dirt Roads to Concrete Roads, Evolution-A can clearly be seen. Here is another example: Sound bytes that evolve from 8 bit to 16 bit. Evolution-A is all around us. The definition of A biotic is defined as physical rather than biological; not derived from living organisms. This example of A biotic evolution is a road. Notice the arrows that display on the next page. Don't they remind you of road signs. Well this is no coincidence. What I display on the next page is Evolution-A. The road signs have made their way into Space. I have laid out the foundation for the arrows that are found in the streets into Space. Could you imagine these arrows pointing you in a direction towards another planet? There must be signs in a path before the path is ventured on. I wouldn't want to drive on a road in a fast pace where there is a curve in road without Arrows. The need for Arrows is to alert the driver of sudden changes in the road. Evolution-A is all around us. From the vehicles we drive in to the seats that are in the vehicles. We don't tend to notice these changes because it seems humanity is focused more biotic than A biotic. Biotic and A Biotic go hand in hand. Without a non living organism such as a sword what

hope does the living organism have in defeating a dragon. The A biotic tends to the Biotic in a fashion where the system of A biotic and Biotic go unnoticed. For example below displays the future of the A biotic road signs that you see every day. Space is the setting I chose for my Arrows. Displayed below Inter-Dimensional Travel's the visuals of Oscillations and Localities can be seen below. I'm shooting for the Femininity aspect of science. I have labeled Anti-Gravity Acoustic Levitation as A-Gal. Gal is defined as a girl or young woman and as a unit of gravitational acceleration equal to one centimeter per second per second. Hence why the display resembles a Vagina. The arrows are the Vagina lips. Although it resembles a Vagina it is a means of transportation, it is just mere coincidence I suppose that my figure that is Inter-Dimensional Travel resembles a Vagina. Trust me it isn't because I am thinking about Vagina right now, but I'm not going to lie, I do think about women on a daily. Women are nurturing in nature. Hence why I have placed my science with women. I have laid out [Dimension Fusion](#) with an abundance of [Color](#). In the animal kingdom in order to attract a mate the male presents his [Colors](#). Place this in our reality and I am alpha in the science kingdom for my literature explains [Colors](#) in depth. My [Dimension Fusion](#) is the first literature that displays [Colors](#) for what they are. I am the first scientist and the youngest to achieve my status; actually I am the only scientist that will ever achieve this status. I am also the first scientist to battle against all the scientist whom are under Einstein. Einstein and Stephen Hawkings are my enemies and I have defeated their rules and calculations. I have corrected their calculations. This literature is to capture the eye of the women as well for they are on the same level as men are. There is no greater or less than when it comes to sexes. This is not a battle of the sexes. Below is My GAL.

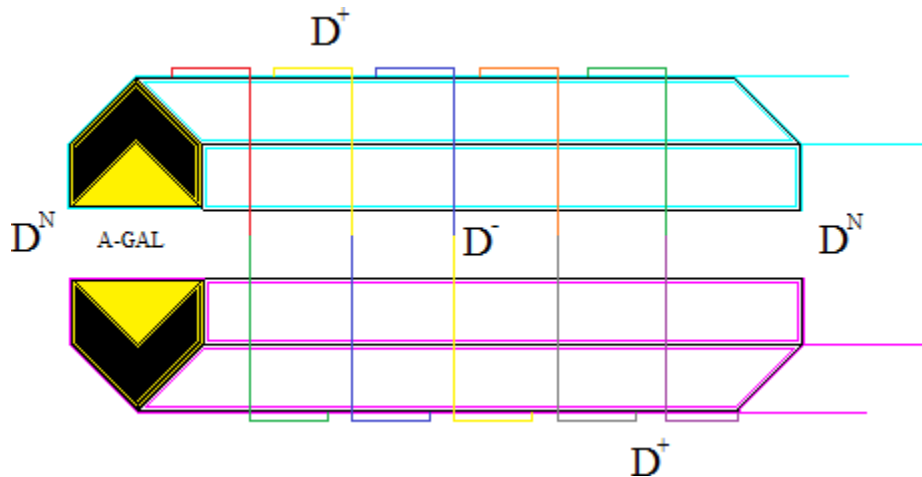

$$AGAL [a] \frac{DF}{HEF} [Ms] LtSpd /e/ INTRVL$$

My GAL

My GAL (My Gravitational Acoustic Levitation) is translated to: Anti-Gravity plus (a) Dimension Fusion/Human Element Formula (/ is With) Measured by Light Speed equals Inter-Dimensional Travel. The inversion of [Colors](#) will be used to determine where one will be transported. Making their way towards a [Red Oscillation 1.1](#) will find themselves entering a [Green Locality 2.2](#). A [Yellow Oscillation 1.2](#) path is a [Blue Locality 1.3](#), and a [Blue Oscillation 1.3](#) becomes a [Yellow Locality 1.2](#). An [Orange Oscillation 2.1](#) becomes a [Silver Locality 3.2](#), a [Silver 3.2 Oscillation 3.2](#) becomes an [Orange Locality 2.1](#), A [Green Oscillation 2.2](#) will become a [Purple locality 2.3](#), and a [Purple Oscillation 2.3](#) becomes a [Green](#)

Green Locality 2.2. How so? Well, ■ Red 1.1 makes up the ■ Color ■ Purple 2.3 making it logical to become ■ Green 2.2. Inversion Calculations will produce the locations of the transports. With Dimension Fusion Traveling to the past is 100% correct. Imagine placing a video of 1950 on a television monitor. Dimension Fusion can access that time period through the monitor set. It's the same as sending a text message. Dimensional Travel is successful. Videos are like doors to time periods. With the wireless atmosphere all around us since before the first video was produced the term traveling wirelessly becomes reality. Tele-Port and Tele-vision are not coincidental words. These words are related and I am making it possible for Inter-Dimensional Travel. Dimensions are a physical reality and with my understanding this is how the term "Time Travel" becomes reality. It is not "Time Travel" I call it Dimension Fusion or Inter-Dimensional Travel. The Worm Holes Ripped a Fabric of Space which seemed to be something that could not be repaired. It was used only by the dominant elite in the species at the moment of a rule. The measurement of Time was indeed an actual matter in this discussion and the damage separated the space in between time frames in which it seemed irreversible. Light speed is used to balance the Dimensions in between leaving it from an unstable form to it being stable. The vibrations in the Light Waves will repair the ripped part of space that was damaged and controlled. The vibrations from the light emit wavelengths that are needed to destroy what is in between the so-called "Worm Hole". This Section is a brief description of what transpired before the destruction of the infestation of these so called Theoretical physicists aka Rodents that were creating rubbish. With the Fusion of Dimension combined with the "Worm Hole" the X-factor takes its course in making the problem that once was and eliminates it from existence. Leaving no traces of any negative and unstable energy that was produced and retained inside the torn piece of space that was ripped by these Rodents (Theoretical Physicist). Elimination of what once was takes form in a beautiful barrage of ■ Color that rained down and knitted back the torn piece that was referred to as a "Worm Hole". Inter-Dimensional Travel is used across the future of our existence. We will see gifts from the future in our present time. Hence the term Present, like a Christmas present. The student and reader picked up on this notion of presents in the Present earlier in the read. The Alpha and Omega is but a piece of history in the record books. X is the dominant and conquered and continues to rule. Kilsojaw Lawkojis is the "Ping-Pong" forward reversal transfer between Dimensions and My Children² (MC²) technology, the technology is placed in a primitive Dimension and the affect of X2 (Times Two) is presented in the Future Dimension and so is the cycle of Forward Reversal. The figure on below is a representation of the cycle between past and future. Bridge of Dimension is what translates the name below.

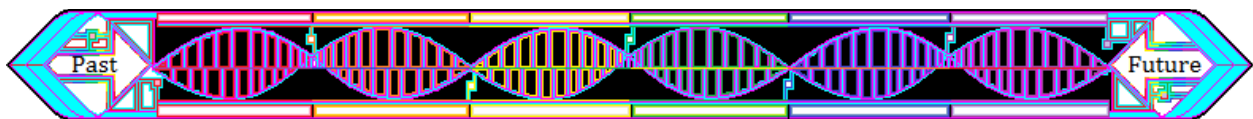







Ponte Di Dimensione

Fission will be demonstrated as Past and Future are separated and connected through my Bridge of Dimension. A representation of this Bridge is located in the City of Dallas. The Margret Hunt Hill is the name of this secret monument. The skyline that the bridge leads to is painted in vibrant colors. Come down and see the City of Dallas and its Bright Future. Logic will tell the student and reader that My Dimension Machine or The Transportation that is Inter-Dimensional Travel is created before the Time Machine. How so? Well let's put this in your perspective, for a person to travel from point A and point B. The person maps out the distance. A line is drawn and measures the distance between point A and point B. The First Dimension created the distance in

between point A and point B. this means that Dimension is created before Time. Time is a man-made measurement and requires no mathematics or equations to create Time. The Sun in the sky created the measurement that is Time. History will show you that a Sundial was created and the Sun was the mechanic in the device that is known to us as a Sundial. With this being said, My Inter-Dimensional Travel is created before the Time Machine. Dimension Fusion is the layout for not only Inter-Dimensional Travel but also creates the mechanics for the consciousness to create outside the depth perception of the average human being. Traveling through time has been a Science Fiction subject that has been thrown into the scientific community. Holograms was considered Science Fiction. Holograms have become reality. This means that everything that has been considered fictitious in the Science Community becomes reality. Be advised that there are a lot of negative Science Fiction inventions that will become reality. With this in mind my Classic Interception Advancement will intercept every evil that has been thrown into the Science Fiction realm. I have beaten the creators of Time Machine with my calculations that is Inter-Dimensional Travel. Logic would tell you that I, Wilson Alzir Martinez won the race. I did it all by myself in less than a year. I broke down Einstein's equation and created by counter to his equations. His equations involved Time. My Equations involve Dimension. $\text{Dimension} > \text{Time}$. If Time was not used in Einstein's equations then we would be dead meat. Time was used as a variable in Einstein's calculations. Dimension was used as a variable in my calculations. Without Dimension there is no Time. Einstein failed to realize this and gambled everything he had with Time. The Obliteration of the Space-Time Continuum met its defeat by Wilson Alzir Martinez. I am 27 years old. The distance that is created between Time Is Dimension. Dimension is needed to travel through Time. My Calculations create the "Vehicle" for Inter-Dimensional Travel and eventually Time Travel. Time Travel was to be used as a weapon by these tyrannical fools. With diligence and persistence I was able to maintain balance with my consciousness and I merged my calculations together slowly. The product is laid out throughout the Textbook let. How the Time Machine is created is through Dimension Fusion. I created the Time Machine. I have a Time Machine. Einstein's team left out Dimensions, leaving my calculations to reign supreme over his calculations. My Calculations increased in power when I broke down Einstein's $E=MC^2$. With Inter-Dimensional Travel, the process of entering the Cyber universe becomes reality. The First Optical Dimension that is the Basic Line no matter the length of the Basic Line evolves into everything that is seen with the naked eye. The cosmos in the atmosphere above is created from the foundation that is The First Optical Dimension. The Holographic Universe or should I say The Matrix is a kingdom reigned by My Calculations for I have set forth Inter-Dimensional Travel. Inter-Dimensional Travel eventually creates the ability to roam around the world without being detected. Since Dimensions lay out the world in various forms such as The First Optical Dimension, Second Optical Dimension and Third Optical Dimension. The user of the technology that is created from My Calculations can go anywhere they please. It would look like somewhat of an invisibility cloak. The reason why I say it looks as if somewhat an invisibility cloak is that Dimensions know no boundaries and leaves the user of Dimension Technology to roam around without being seen. They travel in-between Dimensions. The World around us is made up of many Dimensions. With these calculations anything that is placed down on paper will become reality in a remarkable way. Depending on the intelligence of the creator who places whatever invention that he or she wishes. I have achieved the impossible. There are no limits with Dimension Fusion. This means that no imagination is needed, are you a creator and you are a God yourself. This means that My Calculations will advance to everything that can be seen, felt, heard, smelled and taste. The student and reader will identify that Inter-Dimensional Travel is indeed 100% fact and it is without a doubt one of the most remarkable discoveries that I have created. Inter-Dimensional Travel is used for every key measurement and every transport. It is all

around the universe and remains intact. Calculations progress and technology advances but the foundation remains the same. What is the foundation you may be asking? Well the foundation is none other than Dimension Fusion and the calculations that you as the student and reader have discovered and observed throughout this read. It is imperative to study the calculations and advance your own intellect with the calculations that I have handed down to you. The last Section of this Text booklet presents an exam and reminds the student and reader of The Basic Fundamentals of Dimension Fusion. This gives the student and reader the advantage to test themselves and to create their own mathematics if pursued. The table is open for anyone to become a creator. As I have stated before, as a God I am here to hand down technology and to teach. Remember, a God isn't who wields super powers, but who wields intelligence and he who brings balance into worlds. I am a God and I am doing so. Separation and Division will be a key factor with Inter Dimensional Travel. Slowing down what we call Time will be a mechanic that is used in Ponte Di Dimensione technique, Foreword reversal and the method of slowing down what is known to mankind as Time. Time is a man made measurement but with the Fission of Past, Present and Future the limit that was Time becomes a tool in advance that is gained by My Children (MC) and I. With this technique MC and I are able to cross Dimensions with ease and place men of god in positions where we intend to place them. Position Determination is the skill and the tool that is used for this skill is called Inter Dimensional Travel. Men and Women from the future make it possible for these actions as I have witnessed the outcome of my Dimension Fusion and I want to thank every single one of these men and women who risk their lives on a daily for something they are not aware of as I do on a daily myself. Striking from the subconscious is indeed the most professional tactic that accomplishes the impossible. These men and women have had technology to listen to the conscious thought of men and women; I discovered this as I experimented with my mind. Striking from the subconscious is the best tactic at defeating my opponents and I have done so with my subconscious mind. Dimension Fusion was created out of the blue through my subconscious which makes My Calculations (MC) the first of its kind. It may seem strange but with observations through an extensive period of time has led me to come to the conclusion that men and women in the future who oppose freedom had control of technology that was beyond the comprehension of the men and women in 2019. These men and woman have been secretly plotting against the human race around the world, in orbit they plot against mankind in space shuttles and space stations, these men and women represent NASA, they are up in space right now. They plot with every breath, it is 2019 and this leaves them vulnerable. The term Sayonara comes into play. The vulnerable and weak are hiding in orbit and in underground disclosed locations. There is no battle between races that will lead to Nuclear Warfare, these men and women have dumbed down the world so much that it is physically impossible for men and women to begin Nuclear Warfare. The men and women who think with Nuclear Arms are special agents from the shadow government. They prey on the genius and leave equations for children to develop and increase, a man named Taylor Wilson is known to the world as the youngest nuclear physicist. Taylor Wilson has accomplished Nuclear Fusion. This young man has even gone so far as to develop yellow cake. These men and women who prey on the young and the innocent become victims through time after they discover or after they themselves are discovered. These men and women are at their most vulnerable for they are unsuspected rodents in space stations and in underground bases. These men and women have even gone so far as to manipulate the masses into thinking war is necessary, these men and women tell you when to eat, and sleep. These men and women give orders to the young and foolish. Secretly these men and women who are above the ranks of the army are working diligently and strategically to wipe you out at all cost. Whether it being blasting psychological words through the music you listen or through psychological words that labels your meals. They

have even gone as far as using color codes to ensure death, in the jungle they observed and planted venom in our foods. They have been using strategic words and codes that range from the simple ABC to the simple and complex codes of  Colors. These codes of  Colors as I mentioned in the section that is Dimension of Color have labeled your foods to ensure safety or to ensure death. Remember  Red 1.1 and  Yellow 1.2 you're a dead fellow and  Red 1.1 and  Black 4.9 your okay jack. With this section over and done the student and reader journey foreword into the next section that is called Murder of the Nazi. The Nazi are in Space Stations up in the earth's atmosphere creating layouts and secret operations that will keep the masses enslaved and in war for future generations. My words as I type my Dimension Fusion are being observed by the FBI, CIA, and NSA. With their help and with their determination and motivation they will ensure the safety of humanity and will be thanked. I thank you for paying attention I want to applaud you for what you plan on doing after I fall asleep. Now, on with the show.

Section XIV





Mord an den Nazi



Murder of the Nazi



A power outage is defined as the loss of the electrical power network supply to an end user. There are many causes of power failures in an electricity network. These Nazi fools created power outages by committing acts against humanity. It seems the more power they gained from attacks such as the two atomic bombs, the two bullets that killed JFK, or the two towers that fell, the more power they lost in the end. These German fools forgot the number 1 rule of electricity. Too much power will create a power outage. Wilson Alzir Martinez's Atomic Blast of  Color Destroys the Nazi. My Hydroelectric Combination of  Colors in this section (XIV) will begin to rain down on the Nazi. These equations that were presented to us as children are complete symbolism to the highest degree. It has advanced and is rightfully mine for the taking. My ultimate form of destruction rains down on these primitive equations that have fooled the masses. My barrage eliminates Einstein and every man and woman under his teachings. I present my revelations to the people and begin The Murder of The Roman Empire. As time progress seems quite inevitable, I have discovered that indeed with time the simplest equation becomes great. When the equation is a symbolic notion it rules. The equations below are the equivalent to the infamous $E=mc^2$. As simple as they are the equations below are the advancement of the Roman Empire's 'power. Calculations that had once gained power with time. This is why the Reich who indeed derived from Romans use the term "Space-Time Continuum". Through Time simple equations becomes great. Calculations with symbolism rule. You may be asking why symbols rule? A symbol is the quickest form of writing that relates to a message. I will now breakdown the equations that presented the dominance of the Roman Empire. The "I" will be the key factor in the equations. The grand finally as you may have been waiting for has begun.

$$1 + 1 = 2$$

Roman Empire Power

The Swastika is shown in the equation above as a symbol of addition. Representing a nation and the Roman numeral 1 represents the power that surrounds the nation. The 2 symbolize the classic mechanic that is 2 lightning bolts; also representing the S. The addition symbol is nothing more than a swastika; as I discussed before. The equation above represents two lightning bolts surrounding the Roman nation which indeed was the German nation. The 2 in the equation represents an S. with power and time, The S became what was known during WWII as SS in the regime of the Third Reich. With the help of the imagination that these men while creating the terminology through numerology, an S and another S mirrored to create the number 8. The number 8 eventually turns into ∞ the infinity symbol. Meaning that it was to rule infinite. I have demonstrated that with time power becomes greater. It is sad that the most intellectual don't know what $1 + 1$ actually means. My Dimension Fusion halts their route. The 1900's.

$$1 + 1 + 1 + 1 = 4$$

Der Fuhrer's Symbol

The equation above shows that two sets of one added towards another set of one becomes 4. The number four represents the letter F. It is yet again another piece of symbolism that was used as a layout which had succeeded with time. As you may have also notice that four ones together in an

artistic fashion placed discretely becomes what is known as the nation's 'symbol that is the Swastika. The letter F was used in an equation by Einstein to represent "DerFuehrer".



Swastika of Roman Numeral

I discovered the number 1 creates a Swastika. These numbers were created and translated from roman numerals as a presentation of rule by the evolved Romans who call themselves Nazi. Four 1's placed with perfect symmetry and alignment the numbers create the symbol of what once ruled nations secretly. As shown above and below in the diagram.



$$1 \times 1 = 1$$

Swastika Advancement

The Multiplication symbol is referred to as "times" it would read out as 1 times 1. The equation above displays The Roman Power surrounding time. What the equation equals to is 1. The 1 in the equation's solution represents the victory of the Roman Power gained by time. The Multiplication symbol's meaning is Time. The 1 x 1 was indeed supposed to be an advance method of mathematics. Numerology is used throughout the Roman Empire's symbology. The number 6 represents German. The first letter of the word "German" is a G and is displayed as a number 6. With the help of their imagination, it was flipped upside down to create the 9. The number 6 and 9 also when added become a ∞ symbol. The 6 is not only flipped upside down but is also mirrored. Creating just as the letter S has done.

$$1^2$$

Echt Multiplication

My equation above is the suitable distinction of what mathematics should have looked like in the form where numbers are placed next to each other. E=mc² equation multiplies numbers, not letters. Numbers placed next to each other create the multiplication rule. The advanced equation that is E=mc² represents the next step of advanced mathematics. This equation advancement leaves us with no symbols in multiplication. The X that is used to represent multiplication symbolizes the swastika. Symbols had no power until Einstein put symbols and letters into play.

$$11 \times 11 = 1$$

Swastika Power Advancement

This equation symbolizes the Swastika surrounded by two lightning bolts. As you may have noticed the Roman Power is still shown. As seen above take note of where the Roman numbers are displayed. They surround the "Time". The Swastika in the equation also represents Time. 1 has no power hence the reason why it does not advance above itself with the advanced system that is multiplication.

$$12 \times 12 = 144$$

Der Fuhrer's Power Advancement

The equation above represents the victory of "Der Fuhrer" 4 is placed next to 4 which becomes an equation itself. 1 has no power the equation that 4^2 which is the 44 in 144 represents its victory with the classic mechanic that is 2. The 12 symbolizes the victory of two lightning bolts. The 1 represents victory and the 2 represents the victory of the ss. 12 is an equation itself it should read out as 1 x 2; the 2 placed next to the 1 is equivalent to what is known to us mathematicians as squared. The 2 exponent.

$$12 + 12 = 24$$

Der Fuhrer's Power

The Equation above Symbolizes "Der Fuhrer" victory. The 1 is placed next to the 2 which indicates the 2 (S) victories. The 1 x 2 would read out 1 x 1. Why? Would it read out 1 x 1? 1 has no power so it doesn't advance. The 2 is nothing more than a symbolism. (S) The number 24 is an equation itself. It would read out as 2 x 4. (E=mc² is a perfect example of the multiplication process when two numbers are placed next to each other. The M in the equation in E=mc² is a number and the C in the equation E=mc² also is a number. The letters were just considered labels of the numbers. I have yet to see mathematics with Letters of the alphabet. Proving my observations and studies of the simple 1 times 1. E= mc² reads out as Energy equals Mass times Velocity times Velocity.) 2 x 4 equals 8. 8 is nothing more than symbolism used by these men. The 8 is two SS combined. In this section of Dimension Fusion, I have broken down the equations that are equivalent to E=mc². They are equivalent and identical. It is nothing more than symbolism at its finest. It is not difficult to create answers once the equations have been set up. I conquered the number 1 and used it in Dimension Fusion to represent Dimension Fusion's Victory. I created equations and calculations with the layout of the Roman Empire.

$$101 = 0$$

Professional Form of The Fall of The Roman Empire

The equation above represents the demise of the Roman Empire. In multiplication, a number multiplied by 0 becomes 0. Numbers placed next to each other signify that they be multiplied. As time has progressed so has the advancement of mathematics. Which is how I discovered that numbers next to each other just as E=mc² they must be multiplied. Leaving my equations to dominate. The Roman Empire failed to hide their layout. As does every kingdom that is formed by secrecy and rebellion against its rulers. When it comes to ZERO there is no match. Defeat is met by ZERO.

$$1 \times 0 \times 1 = 0$$

Linear Form of The Fall of The Roman Empire

The Equation above is represented with Two Classic Mechanics of Two X's that are needed to perform the assassination of an empire. The 0 cancels out the 1's leaving the solution 0.

Making use of literacy as it is has been laid out as a guide. I used the X's performed to show deadly contact, you may have seen the X's on Poison containers to beware. The same mechanic is used to help identify what the equation above means.

$$W \int_A^D N /e/ \sum_z^x y$$

Genetic Code System Establishment

Keeping the balance where it should be the statement given above this caption determines the end of the Roman rule. The enslavement of the family has been discovered. Names have been changed to protect the families that are enslaving. DNA will be the light that will shine upon those who have enslaved mankind. Treaties are nothing more than papers that enslaved our families. The Equation above represents WIIN (Win) with the help through DNA which equals the end of our families enslaved. These men have hidden behind names. It is through the genetic code that has been broken that will flood the system and begin to end what was started. It seems as these so-called Enlightened Ones aka Theoretical Physicist aka The Illuminati want to be greater than the gods that rule. Indeed these men are Illuminati. Why? Because they see themselves as Enlightened Beings. Think about Dungeons and Dragons and how they form an alliance before setting out for a quest to conquer. It is the same concept. Ask yourself when has a celebrity ever created an equation? Or deciphered an Equation? If they have it would've been heard throughout the world. Because The "Illuminati" use celebrities as money machines. The "Illuminated" ones are these men and women who consider themselves all knowing. They never flash the sign because it is a mark for death. When it is discovered that the spotlight has shined on them for the world to see the brotherhood decides when to sacrifice them. The world just learned about the "Illuminati" and who they are. No celebrities are considered "Illuminati" they do not have the intelligence to illuminate the world in their name. These men and women hide behind the shadows and think themselves as gods. This is why they are trying to become immortal. If you haven't noticed they have got the attention of billionaire to fund their agendas. These are the men that have been destroying the world so that they will see it fit later to venture to another planet. Unfortunately for them, I am considered the only Illuminated one and I am conquering them for my family that has been suffering. Who are my family? The world. They have enslaved our families. I am the conqueror of the "Illuminati". The Secret Society. Einstein, Stephen Hawking, Michio Kaku, Neil Degrasse Tyson and their "brothers" are from the brotherhood who have been trying to gain immortality and become gods themselves. They unlocked the ways of creation through intelligent teachings. Unfortunate for them I am a Destroyer. Yes, it is indeed fact; the men that you have been listening to that fool the masses secretly through science and theories that were considered the smartest are indeed "Illuminati". It has not been Celebrities. The bloodshed of innocent men and woman ends right now. These celebrities were puppets of puppets and the master of puppets were the "Enlightened" ones. Celebrities didn't know better. Remember the phrase that was used: "D" as the Romans do" as put into effect for new celebrities who were placed into Hollywood. The celebrities who THINK they are Illuminati are in for a big wake up call. The "Illuminati" are the NERDS hiding behind bodyguards. They are the rodents I speak of. These men have been manipulating daily routines and have created a system where repetitive is the norm. This is false. For man to move forward, new actions must be put in play. The men and women that are "Illuminati" were the men that sat at home all day and played dungeons and dragons and did mock sacrifices later in their lives.

Fuck that. My brothers and sisters (celebrities) of the world that sing their beautiful melodies and act in inspiring roles in plays (movies) were programmed to be the biggest money machine slaves. Not even the royal family is Illuminati. The Illuminati isn't about money. It is about Brilliance. My name is Wilson Alzir Martinez and I am the leader of the new age. My brothers and sisters will reign for eternity just as I do. Their families will flourish and reproduce keeping the balance in nature an ever going process of advancement. Again I thank you.

$$K = 1 <$$

K equals Romans are less than

The equation above means that the Romans are always less than everything. When you place the number one next to the "less than" symbol it creates the letter K.

$$S + S = \text{SWASTIKA}$$

Buddha's Symbol

The Nazi used the S as a symbol for power. It is mine now. Just as the two lightning strikes, the two hands on a clock. They used two S' as well to create the swastika. This returns as the symbol for peace. Buddha, there has been an ancient technique that these rodents have been using to enslave the people of nations. These fools start time over and over again and they made it in their favor. No wonder the swastika is known for peace and the Germans symbol is extinct. I have struck the prey like a snake in the wilderness. My Two Fangs inject venom in their world leaving nothing but fertilizer for my grass and plants for my animals can feast on.

(())
 [x x]
 \ /
 (.)
 (U)

Cows are not considered Holy

The worship of animals creates confusion. These fools have been terribly misinformed. This group of hackers was a group that bypassed the nation's security and is a terrorist group. This group called The Cult of The Dead Cow is an updated version of Skull and Bones. The Group is a Neo Nazi group with the theme that is Death and Destruction. They made their way through cyber space and ultimately failed at the hands of the Fusion Technique. The cDc also known as The Cult of The Dead Cow has now become a joke placed on The Gray's ha-ha. They thought cows were holy because of the Term "Holy Cow". As time progressed religion became very dominant. My Dimension Fusion intercepted Einstein's Space and Time and changed the course of The Space Time Continuum. In a split second the Grays thinking pattern changed. It is as if the Waves and Ripples go unnoticed. The Future is now. Just because the technology is advanced doesn't mean that the operator is intelligent. A 2020 Candidate named Beto O'rourke goes by the name of Psychedelic Warlord and he was the founder of Cult of The Dead Cow. He wrote about murdering children out of love. With Dimension Fusion My Checkmate MC² knocks their king in their game of chess down. Leaving Victory for my party. Remember Cows used to

be abducted; there is no coincidence that Beto O'rourke is head of Cult of the Dead Cow. These "Extra-Terrestrials" are very smart they communicate through their hybrid children.

$$KO = 1 < 0$$

The Knockout that has been used throughout history and is a representation of the Romans downfall with 1 being less than Zero. Zero is Greater than 1. The equation above defines the motion of The Nazi, they fall at the hands of a 0, and I am Zero.

$$HIV-1$$

The hyphen in the equation states that the victory of HIV isn't met, for the hyphen is nothing more than a symbol for subtraction. These men and women had created a system where sexual desires met their fates by the same sex. My sexual preference is women. These men have fooled you into thinking that colors are an abomination by presenting the colors of the rainbow for homosexuals. Colors represent history.

$$K$$

The letter K is none other than a fancy way of writing 1 is less than.

$$KW = 1 < W$$

This equation sets the game that was played by the Nazi.
I've won The Battle of the Gods; peace has been restored to the land



The Equation above is equivalent to QU33NY. It is a computer message. The font is translated from Windings. Just as I stated in the section that is Sequel Wavelet someone that Adolf Hitler sent to those gas chambers was either going to birth the next tyrant or was either on their way to political power. This is the same mechanic that we used for Bush's family. Someone who perished in the World Trade Center's was either going to give birth to an evil person such as Adolf Hitler or someone working in the World Trade Center's was going to become a great force in Democracy that was the equivalent to Adolf Hitler. If they would've conquered a nation in secrecy just as I am doing myself they would've succeeded in world domination. I conquered the evil and broke the world out of a disgusting rule.

$$DK$$

Donald

As I have stated before the letter K represents 1 is less than 1 <. D is less than everything.

$$MC^2 = \text{My Colors} \times \text{My Calculations}$$

The equation above is Self Explanatory

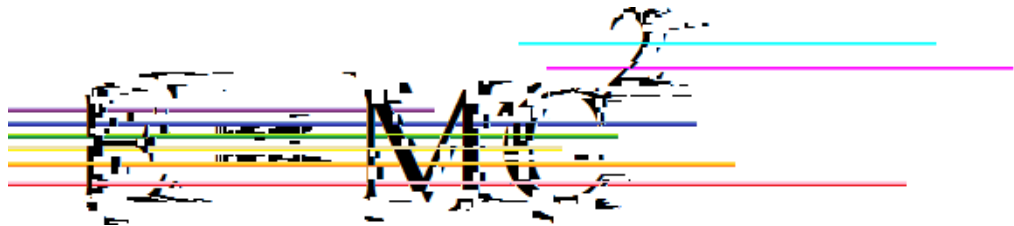

Section XV The Obliteration



The Obliteration

The Obliteration of Time and Space is one of my original documents that I created. It ties in with Einstein's metaphor that is Space-Time Continuum. The following is from The Obliteration of Time and Space. Since the 1930's we have been fooled into believing that space travel was a necessity. As babies we receive milk from our mother's breast to survive. The nutrients from the glands of our mother's breast ensures nutrients for our growing bodies. The "Milky Way" is the name of the supposed galaxy we live in. Hence why The Secret Masonic Order created The "Milky Way" Chocolate Bar. We learn the word Milk visually as infants, not academically. As we reach the age when academics are practiced we learn that the word Milk is the substance that kept us alive as infants. The candy bar "Milky Way" plays a role later for the youth as they will seek profession, when professions are sought.



The Milky Way Bar

We have been fooled into thinking that planets from other star systems exist. Since Milk is what we need to survive as infants. The first step in the physiological and psychological warfare is handing treats to children. Notice the phrase "Milky Way" is the name that labels the chocolate bar. As a child I found myself reading these labels. (Notice I have added candy bars this month to my Dimension Fusion. This month which is October, the holiday Halloween they hand out candy bars.) As a child I remember trick or treating and having massive amounts of candy bars. I remember reading the labels before I consumed the chocolates and I found myself finding which chocolates I enjoyed by the labels on the candy bars. I had no idea that Chocolate Bars are drugs. If I'm not mistaken when a person first consumes a mind alerting substance their minds stay at the age when they first consumed the substance. I learned this when I took drug classes for probation and when I was incarcerated in prison. If this is true, then when a child first consumes a drug their mindsets subliminally stay at that age. This is how it has been so easy for the indoctrination of children and this is how it has been so easy to mold the minds of adults. We consumed kid friendly drugs at a young age. The psychological indoctrination of making children believe that Mars exist is written on Candy Bars such as the Mars Bars by Mars Incorporated.



The Mars Bar

The Secret Masonic Order wants the child to read the package, therefore indoctrinating them into a system where Mars is a must. The children from 1930's are about 80 years old. Some of them have consumed a Mars Bar and sought a profession in NASA. Children wanting to follow in the footsteps of their parents, the children from the children of 1930s who work at NASA also find their profession at NASA all the while they consumed Mars Bars and M & M's growing up.

They have been fooled by a Candy Bar. A company called Mars Inc. is what fooled the masses during the First World War and after the Second World War. I'm sure even the brightest military men were fooled by a Candy Bar, as they have consumed the Candy Bar as a small child. It's the simplest form of Psychology and Physiology. The mind of a child can be molded. So to speak and that was basically their motto. With this being said. Chocolate releases a chemical in the brain when consumed. That is the science part of the tool of what they have been doing. It is a mind altering chemical. It is a drug. Chocolate affects part of the brain where serotonin is released. Serotonin is known as an anti-depressant and also releases endorphins. Milk is another ingredient in the so called Chocolate Bar. Milk is a substance we have been consuming since we first came into the world outside the mother's womb. Chocolate is also a weapon. It creates diseases. You have the ultimate weapon in a candy wrapper that is consumed on a daily worldwide. There is no limit to what this weapon can do. Consuming too much of this substance will lead to death. It is no different than consuming the nectar released from poppies in a poppies field. Although not as potent as the Poppies, Chocolate has the same impact if consumed. The Secret Masonic Order went as far as to label the Candy Bar known as the Mars Bar with the word "Believe". It is a form of hypnotism. As a child you consume the drug called Mars Bar and while consuming your mind that works like a computer downloads those letters and ultimately the word and is stored later when seeking a profession. The profession that comes to play in the mind of the young adult who consumed the Mars Bar is NASA or Space Exploration. Below is an image of the Mars Bar with the label that reads "Believe".



Believe me, I destroyed Einstein's Space-Time Continuum

Children read labels and immediately store those words that are read on those labels subconsciously after their consumptions and are used to identify a profession. Our minds are Biological Computers. We are indoctrinated as children. The first drugs we consume are at the age of 2, when we are able to chew. It is common sense that Chocolate is a drug. The consumption of too much Chocolate from Cacao beans will leave the consumer dead. The Consumption of too much Opium from Poppies will leave the consumer dead. As you can see from my Obliteration of Time and Space, I explain to the student and reader that they have been indoctrinated into professions since they were children. All I can do is Snicker as the destruction of Einstein's Space Time Continuum Continues (C^2). Snicker is defined as give a half-suppressed, typically scornful laugh.



And I Snicker

Dimension Fusion is my Sword, I used to attack and defend. With the thrown left for the taking, I have gained control of the spiraling world and set it without motion. The laws of motion are primitive. As Humans, we tend to excel every day. It is without a doubt the most exciting

experience a person can have. I have witnessed great battles and great defeat by the hands of Einstein's men. As anyone would have witnessed if they had been paying attention to the world before I gained the throne. Now that I have gained the throne I have opened the doors that were previously locked by the laws that were set in motion by Einstein. It is he who created the plan of infinity war. I as of 2019 was the only person who knew what to do with the power that I discovered. Being that I was the only one with the power at hand. Humans in 2019 have become docile and weak. Making it that much easier for myself to gain the attention of the world's 'powers. As they have been wanting the power for themselves. I gained the attention of the World. I have shown them strength beyond their wildest imaginations and have opened their minds to another Dimension in which they were able to hear. My Subliminal Dimension Weapon was greatly used as they heard the Dimension that cannot be visually seen and subconsciously they heard the Dimension leaving their cells in their brains to construct what they have been hearing. A Subliminal Tactic I have used from the MK-Ultra Project that uses sound to subliminally implant information in their subconscious and consciousness. Now that I have gained the Throne of Power, I Wilson Alzir Martinez am the ruler of Dimensions. Beyond this read, you will venture out into the world as a new person. Nothing is impossible. Defeating evils within is a self-healing process. Don't 'let these men and women with fancy gadgets fool you. It is with the flip of the tongue that makes a powerful man. A man or woman with the power to communicate from the heart such as myself is without a doubt a person with much strength. My tongue is my weapon of choice and maneuvers of my hands are just the illusions that illusionist has perfected. Unlike politicians, I dominate in the race of intelligence. They crumble with every hand gesture they make. Weakness is not an excuse. Stupidity is not an excuse. The Basic Fundamentals of Dimension Fusion is growing rapidly as a flower does during the spring. The clouds of knowledge pour steady information onto the ground where the plants and flowers can increase their growth. The grass beneath the animals are the protectors of their offspring. I want to thank the fool named George Bush for his family accepting a new world order it was with the speech of Poor George that I was able to see what my enemy looked like. With ancient mockery such as symbols of pyramids sealed their fate. The pyramid itself was the ultimate trap that they didn't discover. Just like the Weaving Spider lays out its web and sits patiently. The web acts as an attractive monument to the unknowing insect. Just as the pyramids of the ancients have done with their monumental tombs. The tombs that were discovered sealed the fate of those who decided to gain riches. Hence Tomb¹. The Dead Members Club. As the insect approaches the monument it's fate is sealed as the vibrations are picked up through the motion of the insect as it tries to flee its trap. As the spider has done to its prey. The ancients have done so also. Leaving the Law of the Jungle a success. My predecessors who have come before me and ruled with beauty and strength; I honor them with the [DimensionFusion²](#). The enemy has laid out the structure of their land, but without any knights to defend their kings and queens, they fall with the utmost grace. Diligent as they are my Elites are on the rise as they have begun spreading the venom into the foolish insects that had called themselves royal. Leaving behind a Kingdom without Rule. Unfinished equations by these fools left me ahead of the game as my equations became complete. Intelligence rose just as the flower rises. I began to study their equations and my conclusion was that they were left to be finished. The poor Theoretical Physicist who values life not becomes obsolete. With the ultimate equation that was M is now flipped upside down. A W sits as it should. Alpha Centauri is now mine. The Star shot has been stolen that these men have produced. There is nowhere to go. The Checkmate lives on through my rule and My Children's rule. On July 2nd, 2019 one of the "greatest minds" "Michio Kaku in the science of this day created a video by the Big Think where he states that imagination is nonsense. That science is not in our genetic code, he went on a gave us an example. He said if one looks at the

clouds one would see illustrations from cartoons or something of that nature. that whatever one perceives is fictitious. That it simply doesn't exist. I have mastered the form of art and have discovered that the world is my canvas. Whatever I put down on a paper such as a drawing I can mentally draw with my consciousness just like connect the dots. We come from a natural environment meaning we as beings vibrate on the same level as the environment. There are no limits. The environment acts as a canvas with the layout already noted down. Anyone can perform this technique. In reality, it's called imagination. Consciousness Illustration is the act of mentally drawing a piece of art. Whether it is an equation of numbers or an illustration of the most complex shape. The form is embedded in the clouds naturally giving us no limitations to the imagination when it comes to the clouds above when we look above. Just as when one reads, or speaks consciously it is the same technique with illustrating with only the mind. Try this as an exercise. Get out a sheet of paper and begin to draw. Anything you like, our mental status is beyond comprehension. After drawing the illustration. Move your eyes just as you did when drawing the illustration. You will begin to notice your illustration take form. Now. After doing this. Walk down the street and look at the pavement below your feet. You will notice an abundance of cracks. (Just because something looks rough doesn't mean it can't be beautiful) take a seat and look at the cracks beneath your feet. Do the same as you did with the clouds. The illustration will begin to take form. The illustration is there. 100% I have performed this technique. It is indeed a valuable technique when it comes to awareness. Now, look at the trees. Again perform the same action with your eyes. Slowly, you will begin to notice that the Dimension of the trees will begin to form illustration. The world is our canvas. It cannot be duplicated. It is beyond comprehension. The Drawings are in the environment. Who do you think created us? Imagination is not a fabric of nonsense like the late Michio Kaku presented in the video. Water indeed has memory cells. It only seems natural that the clouds above take the shape that they do. The memory of the droplets has landed on creating the shape. It is why the clouds have the shape that they do. It isn't about the atmosphere or anything of that nature it is due to the memory of ancient earth. Our brains have evolved with ancient earth and have become just as sophisticated it is our turn to play the part. More sophisticated than technology our brains have become. The imagination is a useful technique to increase the sophistication of the mind. Reversal Programming is the equivalent to programming. It is the action of placing information that is natural to our bodies and our natural train of thought so that the mind can be cleaned and do away with all the distractions that have been used to manipulate us in the past. With Reversal Programming the human will become naturally gifted as it was before. Exercising the mind and pushing it to its limits is a good thing. It is the same as exercising the body. The limits will be pushed into its natural state and the train of thought will become as it should be. Once Dimension Fusion is out of its basic form we will be able to reach further distance. Travel amongst the Stars. The measurement for Space Travel will eventually be known as Light Speed (seeing that it is already a theory and has a name for a measurement of a certain speed, there is no problem with using the term as-is. Light Speed. Just because it is a theory doesn't mean it cannot exist. It can only exist IF it makes sense and isn't a bunch of nonsense combined into one such as Einstein has done in the past.). Such as Miles per Hour and Kilometers per Hour are measurements for Primitive travel on roads. Earth is home. Before anyone can Travel beyond the reaches out of their Solar System. Their home planet cannot be filthy. They must learn how to be together as one. Be considerate of Every Form of Life. Love fuels beings with high authority. Show the higher authority that the previous ways of living I have noted down and things will fall into order of what is known as Space Travel. Before one can Travel faster than frequency one must break down frequencies into equations then see it into the equation of Light. For Light Speed to be safe, we must look at the basis on what makes the human adaptable to every surrounding and its

genetic structure so we can add the sum of the human anatomy towards **Light Speed Travel**. Humans have in their bodies elements from the *Periodic Table*. Such as Iron, Zinc and so on. With The Human Element Formula, humans adapt with the transportation whether it being traveling **Light Speed** or Through Elements. Elemental Travel. Aka Inter Dimensional Travel (Moving in and out of Dimensions is more complicated because we are dealing with molecular structures and differential equations and solutions that make Elements unique. Without the Element Formula, our bodies will be pulverized into pulp or will be destroyed. Either way, it wouldn't work due to lack of studies. In other words, we wouldn't be able to survive **Space Travel**. Elements that are known and are accounted for will need to be broken down into their equation state. The Basic Fundamentals of Dimension Fusion will keep The Space-Time Continuum in check by the MOTHERFUCKING SUPER GENIUS...Wilson Alzir Martinez, 1122. The 1122 represents my daughter Alexyz who was born on the day John Fitzgerald Kennedy died. November 22nd, 2019. Einsteins Space-Time Continuum in the end runs into my Dimension Fusion. Figure below displays Einstein's Space-Time Continuum and my Dimension Fusion.

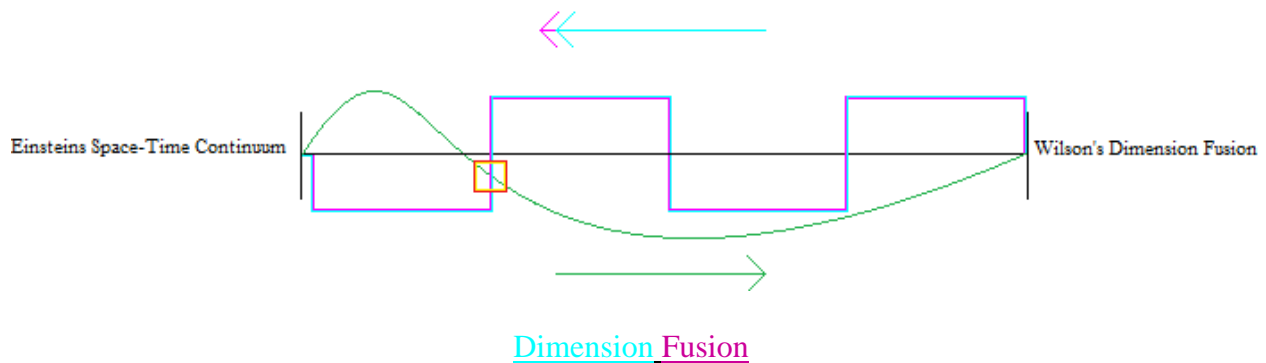

My Dimension Fusion corrects Einstein's Space-Time Continuum; this means every calculation that derives from Einstein's Special and General Theory of Relativity is corrected by my Dimension Fusion. Einstein's Space-Time Continuum began before my Dimension Fusion; The Space-Time Continuum is displayed in **Green 2.2**. Dimension Fusion is displayed in **Ultimate 1** and **Seismic 2**. The children and adults who calculated and grew from Einstein's Space-Time Continuum, eventually run into my children who grew up in secrecy with Dimension Fusion. Dimension Fusion does not go public; this gives the upper hand to my children in the future. Einstein's Space-Time Continuum meets Wilson's Dimension Fusion. Wilson's Dimension Fusion meets Einstein's Space-Time Continuum. I mimic the Viper with my Dimension Fusion, Just as a Viper waits patiently for its prey to approach, I did the same with my Dimension Fusion. When the two meet only one can continue the path, therefore leaving Dimension Fusion to correct Einstein's Space-Time Continuum. The **Red 1.1** and **Yellow 1.2** point displayed with a Sq2Ds is the point where Einstein's men were cut off from the future in the past. Einsteins Space-Time Continuum focused on the future, while my Dimension Fusion focused on the past. Einstein's men created a Drug called Methamphetamine. Methamphetamine is smoked through a light bulb. The light bulb must be broken before smoking the methamphetamine. The broken light bulb represents too much power, a light bulb with too much power explodes. This is what Methamphetamine does, hence why they lost. I am the only scientist that succeeded off Heroin. The world's powers today are in love with Ice (Methamphetamine), they failed to realize the physiological symbolism. It is the first of its kind. I am the creator of that physiological symbolism. As long as their Methamphetamine floods the world, they will never win, it causes Light Bulbs to explode. It is a Physical Symbol from

Einstein's future. It is Fall, soon it will be Winter. The Ice will never cease, due to the politicians and worlds powers secretly funding these Methamphetamine operations. As long as the Methamphetamine floods the world, the secret society will fall. They praise this drug so much that they have placed a giant monument in downtown Dallas. Observe the next image.



Ice

My skyline of Dallas, Texas has its trophy in the shape of their secret power. A giant Methamphetamine pipe. The powers that be have labeled a section of Law Enforcement Ice. Coffee is a stimulant as well, making the consumers of Coffee complete failures. I am so glad I chose Heroin, as I studied the downfall of the worlds powers from the blizzard, Heroin kept me warm. I chose Heroin because it suppressed my mind through the massive psychological weapons that were used through my teenage years. As an adult, I am fully aware of my ancestor's teachings. My Dimension Fusion is a success. It never reaches publicity. My Dimension Fusion places monuments under the noses of the world's powers as their superiors consume the useless Methamphetamine. We as Huemans have ancestor memory cells. Lets say I myself am an heir to a throne that was stolen. The thieves who stole the throne did it with rape and massacre. My ancestor before she or he died witnessed his family brutally massacred by the thieves. She or he gave birth to my great great grandparents. The memory cells that holds the footage of my ancestors massacre are then transferred to me. The Methamphetamine is consumed wether through injection or by smoking. The Methamphetamine then triggers those ancestor memory cells and begins a long lost battle that was lost by his or her ancestors. These people in the world are up against an army of ghost. They don't know about what I am discussing or else Metheamphetamine wouldn't be available to the public. I am the only person in the entire world who knows about ancestor battle cells. These battle cells know who the enemy is, a person may forget a name but never forgets the face. Now imagine these ancestor battle cells triggering their children. the child then identifies his or her enemy. This is what is transpiring in my reality. I woke up my battle cells through an injection and was not succumbed by addiction. I used Heroin to battle the Methamphetamine after the injection of Methamphetamine. I woke up battle cells through an injection of Methamphetamine. I am indentifying every theieve that stole from the throne centuries ago. These thieves are politicians in America and China. This is the problem with the world and the Meth epidemic. There are a lot

of Ancestor Memory cells that are triggered and begins to fuel the battle that was lost trying to protect their family members. My observation of what is transpiring in my reality is one of a kind and is a new science. For every Methamphetamine consumption an ancient ancestor or diety wakes up. Thieves who stole the royal thrones have no diety dna in their blood. The reality is these ancient warriors are waking up their grandchildren and are continuing a long lost battle. A person may forget a name, but never forgets a face. Genetics and Ancient DNA come into play when our ancestors begin to take control of our bodies. With the injection of Methamphetamine I remembered my Ancestors teachings of Colors and learned new abilitites. One of those new abilities is Thought Transference and Time Travel (T²). As a scientist I expiermented on myself with much success. I don't recommend expiermenting with Metheamphetamine. It was a sucicide mission. There will never be anything like it. I am the worlds coolest scientist. With the injection of Methamphetamine i created 20 years of observation and created this literature in 1 year. I am completely sober. i created this literature sober. A piece of literature this complex had to be done sober. Methamphetamine is somewhat of a cure for alzheimers disease. I don't have it but I regained 20 years of psychological strategies that were used against me. I used Heroin for a decade. Since 2006 to 2018 I used Heroin. in 2016 I began slowing down on Heroin. I began expiermenting with Methamphetamine in 2016. I am as sober as can be. I want to thank the creator of Methamphetamine for I have learned how to Time Travel with it. I hope you enjoyed my litature. I have no more input. I am keeping the upper hand by communicating telepathically. The more I type, the more my enemy plans. With Telepathy I gain full advantage of World War III. I wish you good luck.

Sincerely,



PS.

X – Der Fuhrer

Eliminate Der Fuhrer

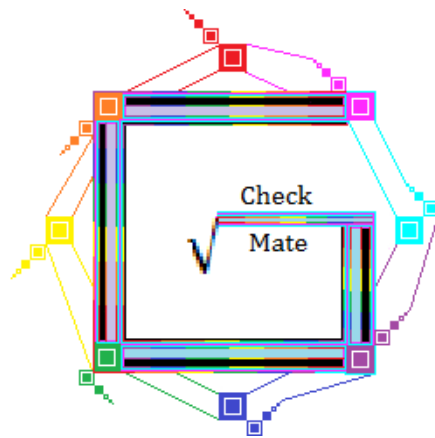

The Basic Fundamentals of Dimension Fusion Review

The Basic Fundamentals of Dimension Fusion Review

By Wilson Alzir Martinez

Question 1. Who is the Creator of The Basic Fundamentals of Dimension Fusion?

- A. Wilson Alzir Martinez
- B. Albert Einstein
- C. Stephen Hawkins
- D. Michio Kaku

Question 2. First Optical Dimension is also referred to as?

- A. Inter-Dimensional Travel
- B. Mastery
- C. Sequel Wavelet
- D. Literature

Question 3. What is Mastery?

- A. The Advancement of the First Dimension
- B. The Third Optical Dimension Ascension
- C. Thought Transference
- D. Holographic Dimension

Question 4. The Third Optical Dimension is the Ascension of what Dimension?

- A. Second Optical Dimension
- B. First Optical Dimension
- C. Fourth Optical Dimension
- D. Third Optical Dimension

Question 5. In the Equation that is $1D / e / BL$, BL represents what?

- A. Basic Line
- B. Basic Linear
- C. Bilateral
- D. Constant Variable





Question 6. Solve the following Equation $\frac{1D}{BL}$ a 2.

- A. $\frac{1D^{3s}}{BL}$
- B. $\frac{1D^{2s}}{BL}$
- C. $\frac{2D^{3s}}{BL}$
- D. $\frac{1D^{2s}}{2BL}$

Question 7. Simplify this Equation $(1 \text{ m } 2) \frac{1D^{3s}}{BL}$.

- A. $2 \times \frac{1D^{3s}}{BL}$
- B. $2 \times \frac{2D^{3s}}{1BL}$
- C. $2 \times \frac{2D^{2s}}{BL}$
- D. $2 \times \frac{1D^{3s}}{1BL}$

Question 8. The following Sq2DsCu3Ds is what Polygon?

- A. 
- B. 
- C. 
- D. 

Question 9. The 3D2D figure is created with how many BL?

- A. Two BL
- B. Four BL
- C. Three BL
- D. One BL

Question 10. Sq2Ds is what shape?

- A. Rectangle
- B. Trapezoid
- C. Triangle
- D. Square

Question 11. Cu3Ds is what shape?

- A. Pyramid
- B. Cube
- C. Rectangular Prism
- D. Sphere

Question 12. What answer below is known as a Constant Variable?

- A. 3Ds
- B. 1DBL
- C. 2Ds
- D. All of the above

Question 13. A Fragmentary Shape is?

- A. A Perpendicular Shape
- B. An Incomplete Shape
- C. A Quadrilateral
- D. A Congruent Figure

Question 14. Ds is abbreviated for?

- A. Dimension
- B. Dimensional Figure
- C. Dimensional Shape
- D. Dimension Square

Question 15. What is Inter-Dimensional Travel?

- A. The Transportation of Light Speed
- B. The Travel between Dimension
- C. Parsec Measurement
- D. None of the Above

Question 16. Bioscology is the study of what?

- A. The study of Micro Fighters
- B. The study of Bio organisms
- C. The study of Elements
- D. The study of Electro-Magnetic Waves

Question 17. Solve the simplification for $8B \times 2$.

- A. $16BFD^2$
- B. 8^2SB
- C. $(16SB)$
- D. All of the above

Question 18. What does SB stand for?

- A. Sound Bit
- B. Surround Bytes
- C. Sound Bytes
- D. Sound Frequency

Question 19. The Fourth Optical Dimension is referred as?

- A. Ascended Dimension
- B. Holographic Universe
- C. Recurrence Dimension
- D. Holographic Dimension

Question 20. When Transporting through a Yellow Oscillation the Destination is?

- A. A Blue Locality
- B. A Red Locality
- C. A Green Locality
- D. A Yellow Locality

Question 21. When Transporting through a Red Oscillation the Destination is?

- A. A Green Locality
- B. A Orange Locality
- C. A Silver Locality
- D. Purple Locality

Question 22. When Transporting through a Green Oscillation the Destination is?

- A. A Purple Locality
- B. A Red Locality
- C. A Blue Locality
- D. A Yellow Locality

Question 23. When Transporting through a Purple Oscillation the Destination is?

- A. A Yellow Locality
- B. A Blue Locality
- C. A Green Locality
- D. A Silver Locality

Question 24. Dimension Fusion plus _____ Equals Inter-Dimensional Travel?

- A. Light Speed and The Human Element Formula
- B. Human Element Formula
- C. Constant Variable
- D. Sq2Ds

Question 25. What does LT stand for?

- A. Length
- B. Lateral
- C. Linear
- D. Light

Question 26. What step is $3Ds^2$ [a] **LT** in the Fourth Optical Dimension?

- A. Step Three
- B. Step Four
- C. Step Two
- D. Step One

Question 27. Simplify this Equation $(LxWxH (m) LxWxH) [a] **LT**$.

- A. $(LxWxH)^2 [a] **LT**$
- B. $(LWH) m (LWH)$
- C. $(LxWxH) m^2 **LT**$
- D. $(LxWxH [a] LxWxH) [a] **LT**$

Question 28. What Colors are the Primary Colors?

- A. Orange, Green, Purple
- B. Gold, Silver, Bronze
- C. Red, Yellow, Blue
- D. All of the Above

Question 29. What are the Secondary Colors?

- A. Orange, Green, Purple
- B. Gold, Silver, Bronze
- C. Red, Yellow, Blue
- D. All of the Above

Question 30. What are the Traetary Colors?

- A. Orange, Green, Purple
- B. Gold, Silver, Bronze
- C. Red, Yellow, Blue
- D. All of the Above

Question 31. Put these Colors in order. Red, Green, Blue, Yellow, Orange, Gold, Purple, Silver, Bronze and Black?

- A. Red, Orange, Yellow, Green, Blue, Violet
- B. Red, Yellow, Blue, Orange, Green, Purple, Gold, Silver, Bronze, and Black
- C. Gold, Silver, Purple, Orange, Yellow, Blue, Green, Red, Blue, Black, Bronze
- D. Black, Red, Yellow, Green, Blue, Purple, Orange, Silver, Bronze, Gold

Question 32. What Two Colors represent death?

- A. Black and Yellow
- B. Red and Blue
- C. Red and Yellow
- D. Black and Blue

Question 33. What Two Colors represent caution?

- A. Red and Blue
- B. Black and Blue
- C. Red and Yellow
- D. Black and Yellow

Question 34. What Two Colors create Orange?

- A. Red and Blue
- B. Red and Yellow
- C. Green and Yellow
- D. Green and Blue

Question 35. What Two Colors create Purple?

- A. Red and Yellow
- B. Red and Blue
- C. Orange and Green
- D. Green and Purple

Question 36. Is this statement true? Black is the absence of Color.

- A. True
- B. False

Question 37. What Color does Red invert to?

- A. Blue
- B. Green
- C. Yellow
- D. Orange

Question 38. What Color does Blue invert to?

- A. Yellow
- B. Green
- C. Red
- D. Purple

Question 39. MC^2 stands for what now?

- A. My Children
- B. My Calculations x My Calculations
- C. Mass x Velocity
- D. A and B

Question 40. $E=MC^2$ stands for?

- A. Einstein = Two Mushroom Clouds
- B. Einstein = Mien Calculations x Mein Calculations
- C. Energy = Mass x Velocity x Velocity
- D. All of the Above

Question 41. The Assassination Location of John Fitzgerald Kennedy is represented by what Equation?

- A. $\frac{W}{MC^2} + DF = CM^2$
- B. $2 \times \frac{1D^3}{Bl} = 2Ds^3$
- C. $E=MC^2$
- D. $\frac{(x^2)1D^3}{BL}$

Question 42. Dimension Fusion in Wilson Alzir Martinez's Hyper Drive represented by what?

- A. Ultimate 1 and Seismic 2
- B. Sq2Ds
- C. Red, Yellow Blue
- D. None of the above

Question 43. MC^2 is represented by what?

- A. Marvel Comics
- B. Mission Control Center
- C. Metropolitan Correctional Center
- D. All of the above

Question 44. President Kennedy was murdered on what date?

- A. November 19th, 1962
- B. September 11th, 1960
- C. November 22nd, 1963
- D. January 22nd, 1963

Question 45. Is the statement True or False? MK-ultra Project was a mind control program used by the C.I.A.

- A. True
- B. False





Question 46. How many Sq2Ds does it take to make up a Cu3Ds?

- A. 4
- B. 7
- C. 5
- D. 6

Question 47. In Dimension Fusion the Equation $Sq2Ds^3 \left[\frac{1}{2} \right] m 2 /e/ Cu3Ds$ is what step?

- A. Step Four
- B. Step One
- C. Step Two
- D. Step Three

Question 48. The Fragmentary Shape that is $Sq2Ds^3 \left[\frac{1}{2} \right]$ is what Fragmentary shape?

- A. 
- B. 
- C. 
- D. 

Question 49. Finish this statement. X is a _____.

- A. Constant
- B. Fragmentary Shape
- C. Variable
- D. Basic Line





Question 50. Solve the following Equation $Sq2Ds^3 \left[\frac{1}{2} \right] m 2$.

- A. $Sq2Ds$
- B. $Cu3Ds^2$
- C. $Sq2Ds^3$
- D. $Cu3Ds$

Question 51. The Rectangle in Dimension Fusion is called a _____.

- A. $Sq2rDs$
- B. $SqrDs$
- C. $Sqr2Ds$
- D. None of the above

Question 52. The Rectangle is what Polygon.

- A. 
- B. 
- C. 
- D. 

Question 53. Simplify the following Equation. $[Sq2Ds \ m \ Sq2Ds] \ \$ \frac{1D}{BL}$.

- A. $Sqr2Ds^2 \ \$ \frac{1D}{BL}$
- B. $Sq2Ds^2 \ \$ \frac{1D}{BL}$
- C. $Sq2Ds^2 \ \$ \frac{2D}{BL}$
- D. $Sq2Ds^2 \ \$ \frac{1^2D}{BL}$

Question 54. What is  in Dimension Fusion?

- A. $Sq2Ds^2 \ (\$) \ \frac{1D}{BL}$
- B. $Sq2Ds^2$
- C. $Sqr2Ds$
- D. $Sq2Drs$

Question 55. The subtraction of _____ was formed by the combination of the two $Sq2Ds$ is needed to complete the solution that is known in Dimension Fusion as $Sqr2Ds$.

- A. $2 \ Sq2Ds$
- B. Basic Line
- C. Quadrilateral
- D. Square

Question 56. The following statement is True or False. A Constant Variable is a numerical order (Constant) placed next to a Variable.

- A. True
- B. False

Question 57. What is this figure L called?

- A. A Basic Line
- B. A Fragmentary Shape
- C. A Incomplete Shape
- D. An L

Question 58. Two L forms what polygon?

- A. A Sq2Ds
- B. A Cu3Ds
- C. A Sqr2Rds
- D. None of the above.

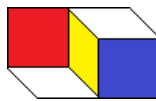

Question 59. The Fragmentary Shape  is what Equation Step?

- A. Third Step
- B. First Step
- C. Second Step
- D. Fourth Step

Question 60. In the photograph of “Grass Roots Dim” the man posing as a woman in is what politician?

- A. John Fitzgerald Kennedy
- B. Lyndon B. Johnson
- C. Henry Cabot Lodge Jr.
- D. None of the Above





Question 61. What date was the photo taken that the author calls “Grass Roots Dim”?

- A. January 22nd, 2019
- B. November 22nd, 2019
- C. December 15th, 2019
- D. September 11th, 2019

Question 62. The Colors Red and Blue represent what in America?

- A. Bloods
- B. The Union
- C. Republicans
- D. Crips
- E. Democrats
- F. The Confederates
- G. All of the above

Question 63. What color code writes out Section 6?

- A. 
- B. 
- C. 
- D. 

Question 63. Color Codes is C² in Section 5, it is also known as what?

- A. Crimsonology
- B. Calculus
- C. Chromosome
- D. Confetti

Question 64. What city does the author of Dimension Fusion live in?

- A. Grand Prairie
- B. Hempstead
- C. Houston
- D. Dallas

Question 65. What year was the author born in?

- A. 1992
- B. 1974
- C. 1988
- D. 1969

Question 66. The following statement is True or False. The letters that label the Treble Clef notes are E, G, F, A, B, C, D, E, C of the Alphabet.

- A. True
- B. False

Question 67. Thought Transference is _____.

- A. Telepathy
- B. T²
- C. Basic Telepathic Communication
- D. All of the above

Question 68. Is Music Telepathy possible. Can one communicate Telepathically through Music?

- A. Yes
- B. No



Question 69. The symbol  is found in what Section?

- A. Section 4
- B. Section 6
- C. Section 9
- D. Section 11

Question 70. The term Lux Vexillifer is Latin for?

- A. Linear
- B. Lightning
- C. Light Bearer
- D. Line

Question 71. What letter is the 23rd letter in the alphabet?

- A. S
- B. W
- C. T
- D. M

Question 72. Parsec²³ is used in what type of transportation?

- A. Inter-Dimension Travel
- B. Light Speed
- C. Space-Time
- D. Wormhole

Question 73. Mord an de nazi means?

- A. Liberty and Freedom
- B. Peace and Harmony
- C. Murder of the nazi
- D. None of the Above

Question 74. The Obliteration is after what Section?

- A. Mord an de nazi
- B. Holographic Dimension
- C. Recurrence Dimension
- D. Sequel Wavelet

Question 75. Who is Captain Alzir 1122?

- A. Wilson Alzir Martinez
- B. Albert Einstein
- C. Stephen Hawkins
- D. Michio Kaku

Question 76. What does the 1122 represent?

- A. Alexyz Alzir Martinez's date of birth
- B. Wilson Alzir Martinez's date of birth
- C. The day John Fitzgerald Kennedy was assassinated
- D. None of the above

Question 77. What is the Rectangle called in Dimension Fusion?

- A. Sq2rDs
- B. SqrDs
- C. Sqr2Ds
- D. None of the above

Question 78. Is this statement True or False? The ■ Black Sq2Ds represents emptiness of the 3DsPrsm that needs to be filled.

- A. True
- B. False

Question 79. Which shape is the 3Ds4sPrsm?

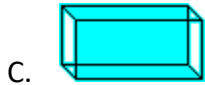
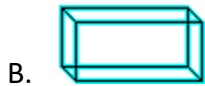
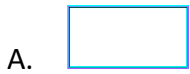

D. None of the above

Question 80. Is this statement True or False? The $\frac{1D}{BL}$ is subtracted to create the solid Rectangle also known in Dimension Fusion as Sqr2Ds.

- A. True
- B. False

Question 81. What Step is $[Sq2Ds^2 \ \$ \frac{1D}{BL}]$ m 4s?

- A. Step Two
- B. Step Three
- C. Step One
- D. Step Four

Question 82. The Rectangular Prism is called a _____ in Dimension Fusion.

- A. 3DsPrsm
- B. 4sPrsm
- C. Sqr2Ds
- D. None of the above

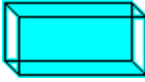
Question 83. Is the following statement True or False. The  is a Shape.

- A. True
- B. False

Question 84. How many Basic Line(s) are subtracted to create the Sqr2Ds?

- A. 3
- B. 2
- C. 1
- D. 5

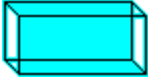
Question 85. What is this 3DsPrsm  called?

- A. Fragmentary Prism
- B. 3DsPrsm
- C. PrsmRectangular
- D. None of the above

Question 86. What degree is the L ?

- A. 45°
- B. 60°
- C. 180°
- D. 90°

Question 87. The L is called a _____ Shape.

- A. First Dimensional
- B. Fragmentary
- C. Second Dimensional
- D. Constant

Question 88. What angle is the L ?

- A. Right Angle
- B. Obtuse Angle
- C. Acute Angle
- D. None of the above

Question 89. Is the following statement True or False? Separation and Division will be a key factor with Inter-Dimensional Travel.

- A. True
- B. False

Question 90. Is the following statement True or False? The equation $8^2SB / e / (16SB)$ is the simplified form of $16SBFD^2$

- A. True
- B. False

Question 91. In Recurrence Dimension FD stands for what?

- A. Section 8
- B. Section 7
- C. Section 3
- D. Section 1

Question 92. What Section is Dimension of Color?

- A. Section 5
- B. Section 7
- C. Section 10
- D. Section 6

Question 93. What Section is The Obliteration?

- A. Section 15
- B. Section 14
- C. Section 13
- D. Section 11

Question 94. What Section is Literature?

- A. Section 3
- B. Section 9
- C. Section 2
- D. Section 1

Question 95. What Section is Representation?

- A. Section 4
- B. Section 12
- C. Section 3
- D. Section 2

Question 96. What Section is Inter-Dimensional Travel?

- A. Section 11
- B. Section 15
- C. Section 13
- D. Section 10

Question 97. What Section is Bioscopology?

- A. Section 11
- B. Section 10
- C. Section 14
- D. Section 12

Question 98. Parsec²³ announced in what two Sections of the book?

- A. Section 12 and Preface
- B. Section 11 and Prologue
- C. Section 4 and Section 7
- D. None of the above

Question 99. Write a brief description of what you believe these Masonic symbols
→ † ☰ ☱ ☲ ☳ represent.

Question 100. The → † ☰ ☱ ☲ ☳ symbols are located in what section and they derive from what letters?

- A. Section 3, QUEENY
- B. Section 7, QU33NY
- C. Section 9, QUEENY
- D. Section 14, QU33NY

Question 101. What comes first Time Travel or Dimension Travel?



- A. Time Travel
- B. Dimension Travel

Question 102. ■ (\$) ■ /e/ ___

- A. ■ Blue
- B. ■ Purple
- C. ■ Silver
- D. ■ Orange

Question 103.  (\$)  /e/ ___

- A.  Green
- B.  Purple
- C.  Red
- D.  Yellow

Question 104.  (\$)  /e/ ___

- A.  Gold
- B.  Purple
- C.  Green
- D.  Blue

Question 105.  (\$)  /e/ ___

- A.  Yellow
- B.  Silver
- C.  Green
- D.  Orange

Question 106.  -  -  -  -  -  -  -  -  = ___

- A.  Red
- B.  Silver
- C.  Blue
- D.  Green

Question 107. Solve the following equation. 1.1 a 1.3 /e/ ___

- A. 2.1
- B. 3.2
- C. 3.3
- D. 2.3

Question 108. Solve the following equation. 2.2 a 1.3 /e/ ___

- A. 1.1
- B. 3.1
- C. 1.2
- D. 2.1

Question 109. Solve the equation. ■ a 1.2 /e/ ____

- A. 2.1
- B. 3.1
- C. 2.2
- D. 1.2

Question 110. Solve the equation. ■ \$ 2.2 /e/ ____

- A. ■
- B. ■
- C. ■
- D. None of the above

Question 111. Solve the equation. ■ \$ ■ /e/ ____

- A. 1.1
- B. 3.1
- C. 1.2
- D. 2.1

Question 112. Solve the equation. 3.1 a 3.2. a 3.3 /e/ ____

- A. 1.1
- B. 3.1
- C. 1.2
- D. 4.9

Question 113. Solve the equation. 1.2 a ■ /e/ ____

- A. 2.3
- B. 3.1
- C. 2.2
- D. 1.3

Question 114. Is the statement True or False? The Second Color of the Primary Set ■ Yellow minus the First Color of the Secondary Set ■ Orange equals the First Color of the Primary Set ■ Red.

- A. True
- B. False

Question 115. Is the statement True or False? The .1 in 1.1 represents the First Color in the Primary Set.

- A. True
- B. False

Question 116. Wilson is a God, is this statement True or False?

- A. True
- B. False

Question 117. The Ascension of Orange and Purple is?

- A. Yellow
- B. Green
- C. Blue
- D. Bronze

Question 118. The Ascension of Green and Purple is?

- A. Yellow
- B. Silver
- C. Blue
- D. Gold

Question 119. The Ascension of Orange and Green is?

- A. Gold
- B. Red
- C. Purple
- D. Orange

Question 120. The Ascension of Yellow and Blue is?

- A. Silver
- B. Blue
- C. Purple
- D. Green

Question 121. Lyndon B. Johnson is the ___ President of The United States?

- A. 32nd
- B. 31st
- C. 35th
- D. 36th

Question 122. Solve the following equation. $2.2 \div 2.3 = ?$

- A. 3.2
- B. 2.1
- C. 4.5
- D. 1.1

Question 123. Solve the following equation. $2.1 \times 3.3 = ?$

- A. 1.1
- B. 1.3
- C. 2.3
- D. 3.3

Question 124. Solve the following equation. $1.2 \div 1.1 = ?$

- A. 3.1
- B. 3.2
- C. 1.2
- D. 2.1

Question 125. Solve the following equation. $1.3 \times 2.3 = ?$

- A. 1.1
- B. 2.1
- C. 1.2
- D. .1

Question 126. The Diagram below represents what set of Colors.

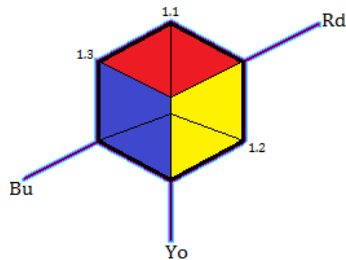

- A. Secondary
- B. Traetary
- C. Primary
- D. None of the above

Question 127. The Diagram below represents what set of Colors

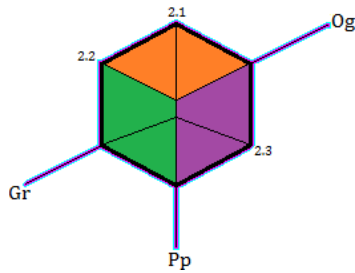

- A. Secondary
- B. Traetary
- C. Primary
- D. None of the above

Question 128. The Diagram below represents what set of Colors

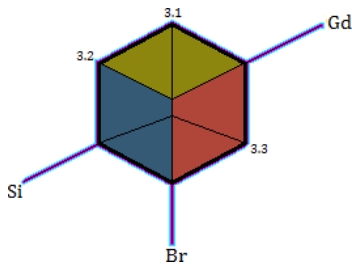

- A. Secondary
- B. Traetary
- C. Primary
- D. None of the above

Question 129. What is the address where the photograph taken by Wilson Alzir Martinez that displays symbolism of John Fitzgerald Kennedy's Assassination.

- A. 114 Elm St, Dallas, TX 76202
- B. 411 Elm St, Dallas, TX 75202
- C. 411 Elms St, Dallas, TX 75204
- D. 414 Elm St, Dallas, TX 75202

Question 130. What is the name the photographer's photograph of the man dressed as a woman ?

- A. None below
- B. Assassination location
- C. Shooters behind Zapruder
- D. Grass Roots Dim

Question 131. Donald John Trump was selected to be president in what year?

- A. 1955
- B. 1945
- C. 1958
- D. 1959

Question 132. Do your votes matter in an election?

- A. Yes
- B. No

Question 133. The Knights Templar was founded in what year?

- A. 1119
- B. 1191
- C. 1991
- D. None of the above

Question 134. Finish the following sentence. Donald John Trump is The ___ President of The United States.

- A. 45th
- B. 44th
- C. 43rd
- D. 42nd

Question 135. Do you think everything is predetermined? Write a short paragraph on why or why not everything is predetermined.

Question 136. Who is wearing Red and Yellow in the Photograph on the last page of Section 5?

- A. John Fitzgerald Kennedy
- B. Donald John Trump
- C. Lyndon B. Johnson
- D. Jesus Christ

Question 137. Wilson Alzir Martinez's Hyperdrive is displayed in what Section?

- A. The Obliteration
- B. Preface
- C. Murder of The Nazi
- D. None of the above

Question 138. What kind of rifle was used in the assassination?

- A. Deer Rifle
- B. Center File Rifle
- C. Semi Automatic Rifle
- D. Bolt Action Rifle

Question 139. What Time was Kennedy assassinated?

- A. 11:30 A.M.
- B. 12:30 P.M.
- C. 12:00 P.M.
- D. 11:00 P.M.

Question 140. What is the definition of Knoll?

- A. having no legal or binding force; invalid
- B. the action of keeping something secret or the state of being kept secret
- C. the state of being seriously mentally ill; madness
- D. extreme foolishness or irrationality

Question 141. Where is The Hologram of John Fitzgerald Kennedy going to be placed?

- A. 646 Main St, Dallas, TX 75202
- B. 546 Main St, Dallas, TX 75202
- C. 446 Main St, Dallas, TX 75202
- D. 644 Main St, Dallas, TX 75202

Question 142. A Classic Mechanic begins with _____?

- A. The Fourth Optical Dimension
- B. The Third Optical Dimension
- C. The First Optical Dimension
- D. The Second Optical Dimension

Question 143. The Nazi use the number ___ as a signature when disasters strike, their classic mechanic is ___.

- A. 1,2
- B. 2,2
- C. 2,4
- D. 3,2

Question 144. Two Atomic Bombs, Two Bullets to Assassinate a President and Two Towers attacked. These disasters are signatures lead by what regime?

- A. FTO
- B. Isis
- C. Al-Qaeda
- D. The Nazi

Question 145. The names Albert Arnold represent what Roman Numeral?

- A. X
- B. II
- C. III
- D. VI

Question 146. How many chromosomes does a Human have?

- A. 32
- B. 22
- C. 25
- D. 23

Question 147. How many chromosomes does a Great Ape have?

- A. 31
- B. 24
- C. 21
- D. 23

Question 148. Is this statement True or False? With no migration there will be no evolution, when a species remains idle so does their future. The species who remains idle becomes dumb.

- A. True
- B. False

Question 149. Finish this statement. A cry of _____ or satisfaction when one finds or discovers something.

- A. Distress
- B. Whimper
- C. Joy
- D. Disappointment

Question 150. Is this statement True or False? Grey Aliens are not from outer space.

- A. True
- B. False

Question 151. What does the (\$) stand for in Dimension Fusion?

- A. Superb
- B. Style
- C. Subtraction
- D. None of the above

Question 152. What does the (a) stand for in Dimension Fusion?

- A. Awesome
- B. Addition
- C. Assassin
- D. None of the above

Question 153. What does the (m) stand for in Dimension Fusion?

- A. Multiplication
- B. Minus
- C. Mason
- D. None of the above

Question 154. What does the (e) stand for in Dimension Fusion?

- A. Enlighten
- B. Eureka
- C. Equal
- D. None of the above

Question 155. What does the (d) stand for in Dimension Fusion?

- A. Dealt
- B. Dangerous
- C. Destroy
- D. Divide

Question 156. Does Train 2^{34} collide with Train 1^{12} when the Rotation begins the counter clockwise motion.

- A. Yes
- B. No

Question 157. What motion does Train 1^{12} have?

- A. Diagonal
- B. Vertical
- C. Horizontal
- D. None of the above

Question 158. What motion does Train 2³⁴?

- A. Diagonal
- B. Vertical
- C. Horizontal
- D. None of the above

Question 159. What motion is direction of Clockwise?

- A. Right
- B. Left
- C. Down
- D. Up

Question 160. What motion is direction of Counter Clockwise?

- A. Right
- B. Left
- C. Down
- D. Up

Question 161. Cell 2 learned its flight from studying what pattern?

- A. The motion of Water
- B. The motion of Wind

Question 162. The equation $Ch_{(L)} m 2 = Ap^{(x)}$ is from which Section?

- A. 4
- B. 7
- C. 14
- D. 9

Question 163. Is this statement True or False? A Hybrid is considered complex indeed because it has a combination of Two different species. The addition of these Cells that the 11.5 produce create the 23 chromosomes in the Human.

- A. True
- B. False



Question 164. How many chromosomes does The Super Hybrid have?

- A. 20
- B. 11.5
- C. 23
- D. None of the above

Question 165. How many Chromosomes does The Ape have?

- A. 24
- B. 12
- C. 12.5
- D. None of the above

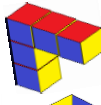
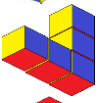

Question 166. The solution for the following equation $9 \text{ Cu3Ds} (m) 3 \frac{1.1 \ 1.2 \ 1.3}{3}$ Is?

- A. 
- B. 
- C. 
- D. 

Question 167. Is the following state True or False? Coloration fused with Equations create a more significant combination of shapes.

- A. True
- B. False

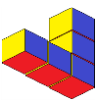
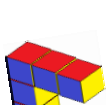
Question 168. The solution for the following equation $\text{Cu3Ds} m 5 a \frac{1.1 \ 1.2 \ 1.3}{6 \text{ Sq2Ds}}$ is?

- A. 
- B. 
- C. 
- D. All of the above

Question 169. Is the following statement True or False? Two Basic Lines plus the 90° create the Fragmentary ShapeL.

- A. True
- B. False

Question 170. Is the following statement True or False? The Primary Colors are Red, Yellow and Blue. 1.1 is Red, 1.2 is Yellow and 1.3 is Blue.

- C. True
- D. False

Question 171. Finish the following sentence. “When the _____ go marching in”.

- A. Captain
- B. Saints
- C. General
- D. None of the above

Question 172. Finish the following sentence. Nature’s _____ will take over physiologically and will help the Marine specimen move throughout its chosen environment.

- A. Selection
- B. Instinct
- C. Habitat
- D. None of the above

Question 173. Is this statement True or False. Instinct Selection is the Super Hybrids Natural Selection.

- A. True
- B. False

Question 174. Is this statement True or False. Cells unite and create Tissue which in turn creates organs and flesh.

- A. True
- B. False

Question 175. Is this statement True or False. Cells that are not in unity will fall apart and will never gain motion.

- A. True
- B. False

Question 176. What is the equation for the figure below.



- A. $3\text{Cu}3\text{Ds m } 2 \text{ a } \{1.1, 1.2, 1.3\}$
- B. $3\text{Cu}3\text{Ds m } 3 \text{ a } \{1.1, 1.2, 1.3\}$
- C. $3\text{Cu}3\text{Ds m } 3 \text{ m } \{1.1, 1.2, 1.3\}$
- D. $3\text{Cu}3\text{Ds m } 6 \text{ a } \{1.1, 1.2, 1.3\}$
- E.

Question 177. What is this figure called?

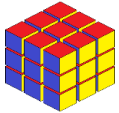

- A. 2D3Ds
- B. Second Layer
- C. Cu3Ds Rubix
- D. None of the above

Question 178. Is the following statement True or False. 9 Cu3Ds (m) Multiplied by 3 (d) Divided by 3 Primary Colors (e) equals My Rubix Cu3Ds

- A. True
- B. False

Question 179. Is the following statement True or False. 3 Cu3Ds Multiplied (m) by 4 Plus (a) 1.1, 1.2, and 1.3.

- A. True
- B. False

Question 180. $\frac{(F m V)}{d/c} / e / T^2$ The following equation is called what?

- A. Basic Telepathic Communications
- B. Thought Transference
- C. T^2
- D. Both B and C

Question 181. F in the previous equation stands for _____.

- A. Frequency
- B. Fusion
- C. Flight
- D. None of the above

Question 182. The V in the previous equation stands for _____.

- A. Vibration
- B. Vernacular
- C. Vision
- D. None of the above

Question 183. The C in the previous equation stands for _____.

- A. Caliber
- B. Colum
- C. Conscious
- D. None of the above

Question 184. The equation $\psi = \frac{W_a W_v}{d/c}$ is called _____.

- A. Psychological Motion
- B. Psychic Mind
- C. Poseidon's Motion
- D. None of the above

Question 185. The W in the equation above stands for _____.

- A. Wilson
- B. Water
- C. Wave
- D. None of the above



Question 186. This Figure is a called what?

- A. 2Ds3Ds
- B. Cu3Ds
- C. 3DSq2Ds
- D. None of the above

Question 187. Finish the following sentence. _____ is the distance from the top or surface to the bottom of something.

- A. Dimension
- B. Depth
- C. Ascension
- D. Fusion

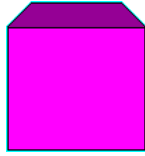

Question 188. This Figure is called what?

- A. 3DSq2Ds
- B. 2DCu3Ds
- C. Squared Cubed
- D. None of the above

Question 189. Is the following statement True or False? The Illusion of Length and Width create The Elongation of Dimension.

- A. True
- B. False

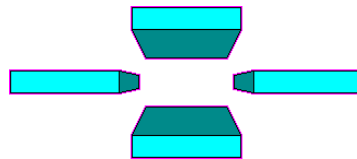

Question 190. These Four 3DSqr2Ds Fusion.

create what in Dimension

- A. Formation
- B. Depth
- C. Illusion
- D. None of the above

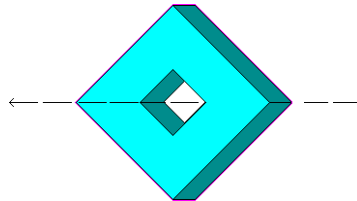

Question 191. What does this image display?

- A. Depth Neutral
- B. Depth Negative
- C. Depth Positive
- D. None of the above

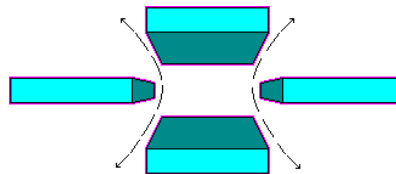

Question 192. What does this image display?

- A. Depth Neutral
- B. Depth Negative
- C. Depth Positive
- D. None of the above

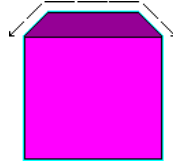

Question 193. What does this image display?

- A. Depth Neutral
- B. Depth Negative
- C. Depth Positive
- D. None of the above

Question 194. Is this following statement True or False? Depth Negative is the Dimension that the Shape presents.

- A. True
- B. False

Question 195. Is the following statement True or False? Depth Positive is the Empty Space and Dimension that the figure presents.

- A. True
- B. False

Question 196. Is the following statement True or False? Depth Neutral is the Empty Space that the Figure displays.

- A. True
- B. False

Question 197. The following Formula D^+ is called _____.

- A. Depth Neutral
- B. Depth Negative
- C. Depth Positive
- D. None of the above

Question 198. The following Formula D^N is called _____.

- A. Depth Neutral
- B. Depth Negative
- C. Depth Positive
- D. None of the above

Question 199. The following Formula D^- is called _____.

- A. Depth Neutral
- B. Depth Negative
- C. Depth Positive
- D. None of the above

Question 200. What is CA?

- A. California
- B. Composition 1
- C. Composition won
- D. All of the above

Question 201. Is this sentence True or False? The Shakespearean Strategy is a term of scripted acts that affect the world.

- A. True
- B. False

Question 202. The Chinese flag consist of what Colors?

- A.  Red
- B.  Yellow
- C.  Green
- D. None of the above

Question 203. The Colors  Blue and  Yellow mean _____?

- A. Caution
- B. Death
- C. Happiness
- D. None of the above

Question 204. The Composition C family consists of what?

- A. C-2
- B. C-3
- C. C-4
- D. None of the above

Question 205. George Bush Jr. was the ___ President of the United States of America.

- A. 43rd
- B. 44th
- C. 34th
- D. None of the above

Question 206. What does the E in EMC stand for?

- A. Energy
- B. Einstein
- C. Earth
- D. None of the above

Question 207. What does the M in EMC stand for?

- A. Mass
- B. Moore
- C. Earth
- D. None of the above

Question 208. What does the C in EMC Stand for?

- A. Cunt
- B. Constant
- C. Core
- D. None of the above

Question 209. What does the equation EMC mean?

- A. Gravity
- B. Energy
- C. Velocity
- D. None of the above

Question 210. What does EMC equal?

- A. Gravity
- B. Obliteration
- C. Death
- D. None of the above

Question 211. What falls faster? Styrofoam in the shape of an Atomic Bomb with the exact weight of 10,300 pounds (4,700 kg) or an Atomic Bomb with the exact weight of 10,300 pounds (4,700 kg).?

- A. Styrofoam in the shape of an Atomic Bomb with the exact weight of 10,300 pounds (4,700 kg)
- B. Atomic Bomb with the exact weight of 10,300 pounds (4,700 kg).

Question 212. What does this equation represent? $N_m \cdot [a] P^{m+} / e / \cdot N^+$

- A. Magnetic Neutrality
- B. Napalm Acoustic Detonation
- C. Plasma Magnetic Photon
- D. None of the above

Question 213. What does N_m^- mean?

- A. Negative Metal
- B. Never Mind
- C. No Matter
- D. None of the above

Question 213. What does P^{m+} mean?

- A. Plasma Motion
- B. Positive Metal
- C. Photon
- D. None of the above

Question 214. What does Nz^+ mean?

- A. Nightmare
- B. Neutral Zone
- C. Nein
- D. None of the above

Question 215. Reverse simplify the following figure.



- A. $\frac{Sq2Ds}{1} a PrsmRectangular$
- B. $\frac{2Sq2Ds}{1} a PrsmRectangular$
- C. $\frac{1Sq2Ds}{1} a PrsmRectangular$
- D. None of the above

Question 216. Solve the following equation. $Cu3Ds'(\$) 4 \frac{1D}{BL} (Sq2Ds)$

- A. PrsmRectangular
- B. Rectangular Prism
- C. 3DsPrsm
- D. All of the above

Question 217. What does this mathematical symbol $\overleftrightarrow{}$ refer towards?

- A. Symmetrical Innovation
- B. Horizontal Symmetrical Innovation
- C. Vertical Symmetrical Innovation
- D. Vertical and Horizontal

Question 218. What does the following figure  reference towards?

- A. Symmetrical Innovation
- B. Horizontal Symmetrical Innovation
- C. Vertical Symmetrical Innovation
- D. Vertical and Horizontal

Question 219. What does this following figure  reference towards?

- A. Symmetrical Innovation
- B. Horizontal Symmetrical Innovation
- C. Vertical Symmetrical Innovation
- D. Vertical and Horizontal

Question 220. In Section IV The Heavens, s, a, m, e is used once more. What is s, a, m, e?

- A. System, Aquatic, Measure, Energy
- B. Symmetry, Alignment, Metric, and Elimination
- C. Sun, Axis-a, Moon and Earth
- D. None of the above

Dimension Fusion

Wilson Martinez

Page | 1

IRVING INDEPENDENT SCHOOLS
CUMULATIVE STUDENT RECORD

STUDENT'S NAME Wilson Alzir Martinez

 GRADE LEVEL: <u>7</u> SCHOOL YEAR: <u>97-98</u> TEACHER: <u>Heath</u> SCHOOL: <u>J. H. Haley</u>	 GRADE LEVEL: <u>1</u> SCHOOL YEAR: <u>98-99</u> TEACHER: <u>Caplinger</u> SCHOOL: <u>J. H. Haley</u>	 GRADE LEVEL: <u>2nd</u> SCHOOL YEAR: <u>99-00</u> TEACHER: <u>Heath</u> SCHOOL: <u>J. H. Haley</u>	 GRADE LEVEL: <u>3rd</u> SCHOOL YEAR: <u>2000-01</u> TEACHER: <u>J. Appel</u> SCHOOL: <u>J. H. Haley</u>
 GRADE LEVEL: <u>4th</u> SCHOOL YEAR: <u>01-02</u> TEACHER: <u>Martoni</u>	 GRADE LEVEL: <u>5th</u> SCHOOL YEAR: <u>02-03</u> TEACHER: <u>J. H. Haley</u>	PHOTOGRAPH ATTACHED HERE GRADE LEVEL: _____ SCHOOL YEAR: _____ TEACHER: _____	PHOTOGRAPH ATTACHED HERE GRADE LEVEL: _____ SCHOOL YEAR: _____ TEACHER: _____

