

**Z97-PRO GAMER**

**HDMI**<sup>™</sup>  
HIGH-DEFINITION MULTIMEDIA INTERFACE

**ASUS**<sup>®</sup>

**Motherboard**

**Copyright © 2015 ASUSTeK COMPUTER INC. All Rights Reserved.**

No part of this manual, including the products and software described in it, may be reproduced, transmitted, transcribed, stored in a retrieval system, or translated into any language in any form or by any means, except documentation kept by the purchaser for backup purposes, without the express written permission of ASUSTeK COMPUTER INC. ("ASUS").

Product warranty or service will not be extended if: (1) the product is repaired, modified or altered, unless such repair, modification or alteration is authorized in writing by ASUS; or (2) the serial number of the product is defaced or missing.

ASUS PROVIDES THIS MANUAL "AS IS" WITHOUT WARRANTY OF ANY KIND, EITHER EXPRESS OR IMPLIED, INCLUDING BUT NOT LIMITED TO THE IMPLIED WARRANTIES OR CONDITIONS OF MERCHANTABILITY OR FITNESS FOR A PARTICULAR PURPOSE. IN NO EVENT SHALL ASUS, ITS DIRECTORS, OFFICERS, EMPLOYEES OR AGENTS BE LIABLE FOR ANY INDIRECT, SPECIAL, INCIDENTAL, OR CONSEQUENTIAL DAMAGES (INCLUDING DAMAGES FOR LOSS OF PROFITS, LOSS OF BUSINESS, LOSS OF USE OR DATA, INTERRUPTION OF BUSINESS AND THE LIKE), EVEN IF ASUS HAS BEEN ADVISED OF THE POSSIBILITY OF SUCH DAMAGES ARISING FROM ANY DEFECT OR ERROR IN THIS MANUAL OR PRODUCT.

SPECIFICATIONS AND INFORMATION CONTAINED IN THIS MANUAL ARE FURNISHED FOR INFORMATIONAL USE ONLY, AND ARE SUBJECT TO CHANGE AT ANY TIME WITHOUT NOTICE, AND SHOULD NOT BE CONSTRUED AS A COMMITMENT BY ASUS. ASUS ASSUMES NO RESPONSIBILITY OR LIABILITY FOR ANY ERRORS OR INACCURACIES THAT MAY APPEAR IN THIS MANUAL, INCLUDING THE PRODUCTS AND SOFTWARE DESCRIBED IN IT.

Products and corporate names appearing in this manual may or may not be registered trademarks or copyrights of their respective companies, and are used only for identification or explanation and to the owners' benefit, without intent to infringe.

**Offer to Provide Source Code of Certain Software**

This product contains copyrighted software that is licensed under the General Public License ("GPL"), under the Lesser General Public License Version ("LGPL") and/or other Free Open Source Software Licenses. Such software in this product is distributed without any warranty to the extent permitted by the applicable law. Copies of these licenses are included in this product.

Where the applicable license entitles you to the source code of such software and/or other additional data, you may obtain it for a period of three years after our last shipment of the product, either

(1) for free by downloading it from <http://support.asus.com/download>

or

(2) for the cost of reproduction and shipment, which is dependent on the preferred carrier and the location where you want to have it shipped to, by sending a request to:

ASUSTeK Computer Inc.  
Legal Compliance Dept.  
15 Li Te Rd.,  
Beitou, Taipei 112  
Taiwan

In your request please provide the name, model number and version, as stated in the About Box of the product for which you wish to obtain the corresponding source code and your contact details so that we can coordinate the terms and cost of shipment with you.

The source code will be distributed WITHOUT ANY WARRANTY and licensed under the same license as the corresponding binary/object code.

This offer is valid to anyone in receipt of this information.

ASUSTeK is eager to duly provide complete source code as required under various Free Open Source Software licenses. If however you encounter any problems in obtaining the full corresponding source code we would be much obliged if you give us a notification to the email address [gpl@asus.com](mailto:gpl@asus.com), stating the product and describing the problem (please DO NOT send large attachments such as source code archives, etc. to this email address).

# Contents

Safety information .....	iv
About this guide .....	iv
Package contents .....	vi
Z97-PRO GAMER specifications summary .....	vi

## Chapter 1: Product introduction

1.1 Before you proceed .....	1-1
1.2 Motherboard overview .....	1-1
1.3 Central Processing Unit (CPU) .....	1-3
1.4 System memory .....	1-7
1.5 Expansion slots.....	1-18
1.6 Jumpers .....	1-21
1.7 Connectors .....	1-22
1.8 Onboard LEDs.....	1-32
1.9 Software support.....	1-33

## Chapter 2: BIOS information

2.1 Managing and updating your BIOS .....	2-1
2.2 BIOS setup program .....	2-6
2.3 My Favorites .....	2-15
2.4 Main menu .....	2-16
2.5 Ai Tweaker menu.....	2-18
2.6 Advanced menu .....	2-30
2.7 Monitor menu .....	2-40
2.8 Boot menu .....	2-45
2.9 Tool menu .....	2-51
2.10 Exit menu .....	2-52

## Appendices

Notices.....	A-1
ASUS contact information .....	A-4

## Safety information

### Electrical safety

- To prevent electrical shock hazard, disconnect the power cable from the electrical outlet before relocating the system.
- When adding or removing devices to or from the system, ensure that the power cables for the devices are unplugged before the signal cables are connected. If possible, disconnect all power cables from the existing system before you add a device.
- Before connecting or removing signal cables from the motherboard, ensure that all power cables are unplugged.
- Seek professional assistance before using an adapter or extension cord. These devices could interrupt the grounding circuit.
- Ensure that your power supply is set to the correct voltage in your area. If you are not sure about the voltage of the electrical outlet you are using, contact your local power company.
- If the power supply is broken, do not try to fix it by yourself. Contact a qualified service technician or your retailer.

### Operation safety

- Before installing the motherboard and adding components, carefully read all the manuals that came with the package.
- Before using the product, ensure all cables are correctly connected and the power cables are not damaged. If you detect any damage, contact your dealer immediately.
- To avoid short circuits, keep paper clips, screws, and staples away from connectors, slots, sockets and circuitry.
- Avoid dust, humidity, and temperature extremes. Do not place the product in any area where it may be exposed to moisture.
- Place the product on a stable surface.
- If you encounter technical problems with the product, contact a qualified service technician or your retailer.

## About this guide

This user guide contains the information you need when installing and configuring the motherboard.

### How this guide is organized

This guide contains the following parts:

- **Chapter 1: Product introduction**  
This chapter describes the features of the motherboard and the new technology it supports. It includes descriptions of the switches, jumpers, and connectors on the motherboard.
- **Chapter 2: BIOS information**  
This chapter discusses changing system settings through the BIOS Setup menus. Detailed descriptions for the BIOS parameters are also provided.

## Where to find more information

Refer to the following sources for additional information and for product and software updates.

### 1. ASUS websites

The ASUS website provides updated information on ASUS hardware and software products. Refer to the ASUS contact information.

### 2. Optional documentation

Your product package may include optional documentation, such as warranty flyers, that may have been added by your dealer. These documents are not part of the standard package.

## Conventions used in this guide

To ensure that you perform certain tasks properly, take note of the following symbols used throughout this manual.



**DANGER/WARNING:** Information to prevent injury to yourself when completing a task.



**CAUTION:** Information to prevent damage to the components when completing a task.



**IMPORTANT:** Instructions that you **MUST** follow to complete a task.



**NOTE:** Tips and additional information to help you complete a task.

## Typography

**Bold text**

Indicates a menu or an item to select.

*Italics*

Used to emphasize a word or a phrase.

<Key>

Keys enclosed in the less-than and greater-than sign means that you must press the enclosed key.

Example: <Enter> means that you must press the Enter or Return key.

<Key1> + <Key2> + <Key3>

If you must press two or more keys simultaneously, the key names are linked with a plus sign (+).

## Package contents

Check your motherboard package for the following items.

<b>Motherboard</b>	ASUS Gaming Motherboard – Z97-PRO GAMER
<b>Cables</b>	4 x Serial ATA 6.0 Gb/s cables
<b>Accessories</b>	1 x I/O Shield 1 x ASUS SLI bridge connector
<b>Application DVD</b>	Support DVD
<b>Documentation</b>	User Guide



If any of the above items is damaged or missing, contact your retailer.

## Z97-PRO GAMER specifications summary

<b>CPU</b>	<p>LGA1150 socket for the 4th Generation, New 4th Generation and 5th Generation Intel® Core™ i7 / Core™ i5 / Core™ i3, Pentium®, and Celeron® processors</p> <p>Supports Intel® 22nm CPU</p> <p>Supports Intel® Turbo Boost Technology 2.0*</p> <p>* The Intel® Turbo Boost Technology 2.0 support depends type of CPU installed in your system.</p> <p>** Refer to <a href="http://www.asus.com">www.asus.com</a> for Intel® CPU support list.</p>
<b>Chipset</b>	Intel® Z97 Express Chipset
<b>Memory</b>	<p>4 x DIMM, maximum 32 GB, DDR3 3200(O.C.)/3100(O.C.)/3000(O.C.)/2933(O.C.)/2800(O.C.)/2666(O.C.)/2500(O.C.)/2400(O.C.)/2200(O.C.)/2133(O.C.)/2000(O.C.)/1866(O.C.)/1600/1333 MHz, non-ECC, un-buffered memory</p> <p>Dual-channel memory architecture</p> <p>Supports Intel® Extreme Memory Profile (XMP)</p> <p>* Hyper DIMM support is subject to the physical characteristics of individual CPUs. Please refer to Memory QVL (Qualified Vendors List) for details.</p> <p>** Refer to <a href="http://www.asus.com">www.asus.com</a> for the latest Memory QVL (Qualified Vendors List).</p>
<b>Graphics</b>	<p>Integrated graphics processor - Intel® HD Graphics support</p> <p>Multi-VGA output support: HDMI / DVI-D / RGB ports</p> <ul style="list-style-type: none"> <li>- Supports HDMI with maximum resolution of 4096 x 2160 @ 24 MHz or 2560 x 1600 @ 60 Hz</li> <li>- Supports DVI-D with maximum resolution of 1920 x 1200 @ 60 Hz</li> <li>- Supports RGB with maximum resolution of 1920 x 1200 @ 60 Hz</li> <li>- Supports up to three displays simultaneously</li> </ul> <p>Supports Intel® InTru™ 3D, Quick Sync Video, Intel® Clear Video HD Technology, and Intel® Insider™</p> <p>Maximum shared memory of 512 MB</p>
<b>Expansion slots</b>	<p>2 x PCI Express 3.0 / 2.0 x16 slots (single at x16 mode or dual at X8 mode)</p> <p>1 x PCI Express 2.0 x16 slot (max. at x4 mode, compatible with PCIe x1 and x4 devices. When PCIEX1_1 or PCIEX1_2 is occupied by x1 device, PCIEX16_3 will run at x2 mode)</p> <p>2 x PCI Express 2.0 x1 slots (share bandwidth with M.2 Socket 3)*</p> <p>2 x PCI slots</p>

(continued on the next page)

## Z97-PRO GAMER specifications summary

<b>Multi-GPU Support</b>	<p>Supports NVIDIA® Quad-GPU SLI™ Technology</p> <p>Supports AMD® Quad-GPU CrossFireX™ Technology</p>
<b>Audio</b>	<p>SupremeFX 8-Channel High Definition Audio CODEC</p> <ul style="list-style-type: none"> <li>- Supports Jack-detection, Multi-streaming, and Front Panel MIC Jack-retasking</li> <li>- High quality 115dB SNR stereo playback output</li> </ul> <p>Audio Features:</p> <ul style="list-style-type: none"> <li>- SupremeFX Shielding™ Technology</li> <li>- ELNA premium audio capacitors</li> <li>- Headphone AMP</li> <li>- Sonic Radar II</li> <li>- Optical S/PDIF out port at back panel</li> </ul>
<b>Storage</b>	<p>Intel® Z97 Express Chipset with RAID 0, 1, 5, 10 and Intel® Rapid Storage Technology 13 support</p> <ul style="list-style-type: none"> <li>- 1 x SATA Express port (gray, compatible with 2 x SATA 6.0 Gb/s ports)</li> <li>- 1 x M.2 Socket 3 with M Key, type 2260/2280 storage devices support (both SATA &amp; PCIE mode)*</li> <li>- 4 x SATA 6.0 Gb/s ports (gray)</li> <li>- Supports Intel® Smart Response Technology, Intel® Rapid Start Technology, and Intel® Smart Connect Technology**</li> </ul> <p>* M.2 Socket 3 shares bandwidth with PCIe1_1 and PCIe1_2 (in PCIE mode) and SATA6G_4 (in SATA mode), and supports M Key and type 2260/2280 storage devices.</p> <p>** These functions work depending on the type of CPU installed.</p>
<b>LAN</b>	<p>Intel® Gigabit LAN</p> <p>Anti-surge LANGuard</p> <p>GameFirst II</p>
<b>USB</b>	<p>Intel® Z97 Express Chipset</p> <ul style="list-style-type: none"> <li>- 6 x USB 3.0 / 2.0 ports* (2 ports at mid-board, 4 ports at rear panel, blue)</li> <li>- 8 x USB 2.0 ports (6 ports at mid-board, 2 ports at rear panel)</li> </ul> <p>* with ASUS USB 3.0 Boost support</p>
<b>ASUS gaming features</b>	<p><b>Gamer's Guardian</b></p> <ul style="list-style-type: none"> <li>- ESD Guards on VGA, LAN, Audio, KBMS and USB 3.0/ 2.0 ports</li> <li>- DRAM Overcurrent Protection</li> <li>- 10K Black Metallic Capacitors</li> <li>- Stainless Steel Back I/O</li> <li>- ASUS DIGI+ VRM</li> </ul> <p><b>Performance Optimization</b></p> <p><b>ASUS Dual Intelligent Processors 5</b></p> <ul style="list-style-type: none"> <li>- 5-Way Optimization tuning key perfectly consolidates TPU, EPU, DIGI+ Power Control, Fan Xpert 3, and Turbo App</li> </ul> <p><b>ASUS DIGI+ VRM</b></p> <ul style="list-style-type: none"> <li>- ASUS DIGI+ VRM utility</li> </ul> <p><b>ASUS EPU</b></p> <ul style="list-style-type: none"> <li>- EPU</li> </ul> <p><b>ASUS TPU</b></p> <ul style="list-style-type: none"> <li>- Auto Tuning, TurboV, GPU Boost</li> <li>- Fan Xpert 3 featuring Fan Auto Tuning function and multiple thermistors selection for optimized system cooling control</li> </ul>

(continued on the next page)

# Z97-PRO GAMER specifications summary

<b>ASUS gaming features</b>	<p><b>Interactive HomeCloud</b></p> <p><b>Media Streamer</b></p> <ul style="list-style-type: none"><li>- Pipe music or movies from your PC to a smart TV</li><li>- Media Streamer app for portable smartphone/tablet, supporting iOS7 and Android 4.0 system</li></ul> <p><b>Gaming Scenario</b></p> <p><b>Steam support</b></p> <ul style="list-style-type: none"><li>- Compatible with the most fun gaming platform under Windows system</li></ul> <p><b>EZ DIY</b></p> <p><b>Push Notice</b></p> <ul style="list-style-type: none"><li>- Monitor your PC status with smart devices in real time</li></ul> <p><b>UEFI BIOS EZ Mode</b> featuring friendly graphics user interface</p> <ul style="list-style-type: none"><li>- O.C. Tuner</li><li>- CrashFree BIOS 3</li><li>- EZ Flash 2</li></ul> <p><b>Q-Design</b></p> <ul style="list-style-type: none"><li>- ASUS Q-Shield</li><li>- ASUS Q-DIMM</li><li>- ASUS Q-Slot</li></ul> <p><b>ASUS Exclusive Features</b></p> <ul style="list-style-type: none"><li>- USB 3.0 Boost featuring speedy USB 3.0 transmission</li><li>- AI Suite 3</li><li>- Disk Unlocker</li><li>- AI Charger</li></ul>
<b>Rear Panel I/O ports</b>	<p>1 x PS/2 keyboard/mouse combo port</p> <p>1 x Optical S/PDIF out</p> <p>1 x DVI-D port</p> <p>1 x HDMI port</p> <p>1 x RGB port</p> <p>1 x LAN (RJ-45) port</p> <p>4 x USB 3.0 / 2.0 ports</p> <p>2 x USB 2.0 / 1.1 ports</p> <p>8-channel audio I/O ports</p>

(continued on the next page)



## Z97-PRO GAMER specifications summary

<b>Internal connectors</b>	<ul style="list-style-type: none"> <li>1 x 19-pin USB 3.0 / 2.0 connector support additional 2 USB 3.0 / 2.0 ports</li> <li>3 x USB 2.0 / 1.1 connectors support additional 6 USB 2.0 / 1.1 ports</li> <li>1 x System panel connector</li> <li>1 x S/PDIF out header</li> <li>1 x Front panel audio connector (AAFP)</li> <li>4 x SATA 6.0 Gb/s connectors (gray)</li> <li>1 x M.2 Socket 3 for M Key, type 2260/2280 devices</li> <li>1 x SATA Express connector, compatible with 2 x SATA 6.0 Gb/s ports</li> <li>1 x 4-pin CPU fan connector</li> <li>1 x 4-pin CPU optional fan connector</li> <li>3 x Chassis fan connectors (4-pin) for both 3-pin (DC mode) and 4-pin (PWM mode) coolers control</li> <li>1 x Thermal sensor connector</li> <li>1 x COM header</li> <li>1 x TPM header</li> <li>1 x Clear CMOS jumper</li> <li>1 x 24-pin EATX power connector</li> <li>1 x 8-pin ATX 12V power connector</li> </ul>
<b>BIOS features</b>	64 Mb Flash ROM, UEFI AMI BIOS, PnP, DMI 2.7, WfM2.0, SM BIOS 2.8, ACPI 5.0, Multi-language BIOS, ASUS EZ Flash 2, ASUS CrashFree BIOS 3, F11 EZ Tuning Wizard, F6 Qfan Control, F3 My Favorites, Quick Note, Last Modified Log, F12 PrintScreen function, F3 Shortcut function, and ASUS DRAM SPD (Serial Presence Detect) memory information
<b>Manageability</b>	WfM 2.0, DMI 2.7, WOL by PME, PXE
<b>Support DVD</b>	<ul style="list-style-type: none"> <li>Drivers</li> <li>ASUS utilities</li> <li>EZ Update</li> <li>Anti-virus software (OEM version)</li> </ul>
<b>OS support</b>	Windows® 8.1, Windows® 8, Windows® 7
<b>Form factor</b>	ATX form factor: 12.0 in. x 9.6 in. (30.5 cm x 24.4 cm)



Specifications are subject to change without notice.



# Product introduction

# 1

## 1.1 Before you proceed

Take note of the following precautions before you install motherboard components or change any motherboard settings.



- 
- Unplug the power cord from the wall socket before touching any component.
  - Before handling components, use a grounded wrist strap or touch a safely grounded object or a metal object, such as the power supply case, to avoid damaging them due to static electricity.
  - Hold components by the edges to avoid touching the ICs on them.
  - Whenever you uninstall any component, place it on a grounded antistatic pad or in the bag that came with the component.
  - Before you install or remove any component, ensure that the ATX power supply is switched off or the power cord is detached from the power supply. Failure to do so may cause severe damage to the motherboard, peripherals, or components.
- 

## 1.2 Motherboard overview

Before you install the motherboard, study the configuration of your chassis to ensure that the motherboard fits.



---

Unplug the power cord before installing or removing the motherboard. Failure to do so can cause you physical injury and damage to motherboard components.

---

### 1.2.1 Placement direction

When installing the motherboard, place it into the chassis in the correct orientation. The edge with external ports goes to the rear part of the chassis as indicated in the image.

### 1.2.2 Screw holes

Place eight screws into the holes indicated by circles to secure the motherboard to the chassis.



---

Do not overtighten the screws! Doing so can damage the motherboard.

---



## 1.2.4 Layout contents

Connectors/Jumpers/Slots/LED	Page
1. ATX power connectors (24-pin EATXPWR, 8-pin ATX12V)	1-26
2. CPU and chassis fan connectors (4-pin CPU_FAN, 4-pin CPU_OPT; 4-pin CHA_FAN1, 4-pin CHA_FAN2, 4-pin CHA_FAN3)	1-25
3. Intel® LGA1150 CPU socket	1-3
4. Q LEDs (BOOT_DEVICE_LED, VGA_LED, DRAM_LED, CPU_LED)	1-32
5. DDR3 DIMM slots	1-7
6. USB 3.0 connector (20-1 pin USB3_12)	1-28
7. M.2 Socket 3	1-31
8. Intel® Z97 Serial ATA 6.0 Gb/s connector (7-pin SATA6G_1~6, SATAEXPRESS)	1-29
9. Standby Power LED (SB_PWR)	1-32
10. System panel connector (20-8 pin F_PANEL)	1-30
11. USB 2.0 connectors (10-1 pin USB910, USB1112, USB1314)	1-28
12. Serial port connectors (10-1 pin COM)	1-24
13. TPM connector (20-1 pin TPM)	1-24
14. Thermal sensor connector (2-pin T_SENSOR)	1-31
15. Clear RTC RAM (3-pin CLRTC)	1-21
16. Digital audio connector (4-1 pin SPDIF_OUT)	1-27
17. Front panel audio connector (10-1 pin AAFP)	1-27

## 1.3 Central Processing Unit (CPU)

This motherboard comes with a surface mount LGA1150 socket designed for the 4th Generation, New 4th Generation and 5th Generation Intel® Core™ i7 / Core™ i5 / Core™ i3, Pentium®, and Celeron® processors.

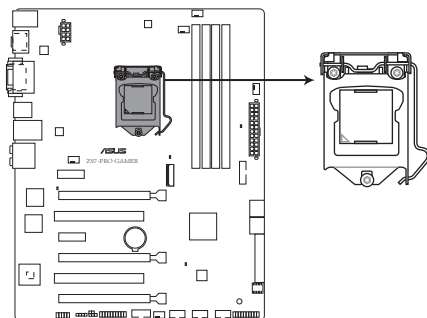

**Z97-PRO GAMER CPU socket LGA1150**



---

Unplug all power cables before installing the CPU.

---



- Ensure that you install the correct CPU designed for the LGA1150 socket only. DO NOT install a CPU designed for LGA1155 and LGA1156 sockets on the LGA1150 socket.
  - Upon purchase of the motherboard, ensure that the PnP cap is on the socket and the socket contacts are not bent. Contact your retailer immediately if the PnP cap is missing, or if you see any damage to the PnP cap/socket contacts/motherboard components.
  - Keep the cap after installing the motherboard. ASUS will process Return Merchandise Authorization (RMA) requests only if the motherboard comes with the cap on the LGA1150 socket.
  - The product warranty does not cover damage to the socket contacts resulting from incorrect CPU installation/removal, or misplacement/loss/incorrect removal of the PnP cap.
- 

### 1.3.1 Installing the CPU

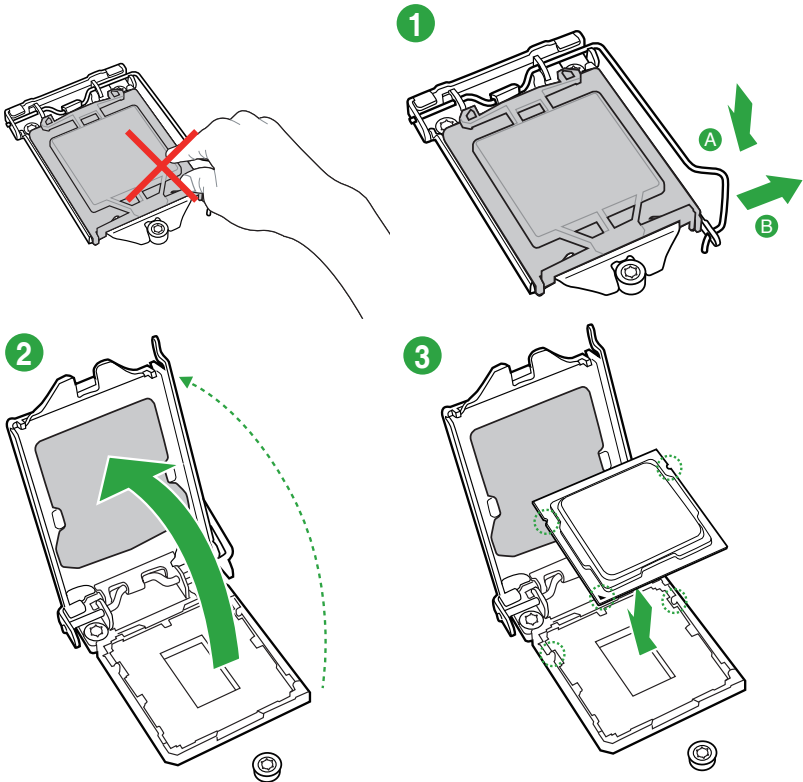

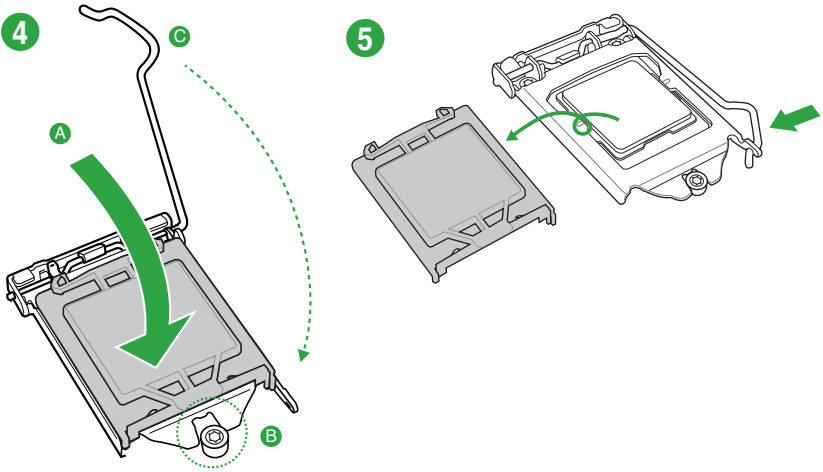

### 1.3.2 CPU heatsink and fan assembly installation

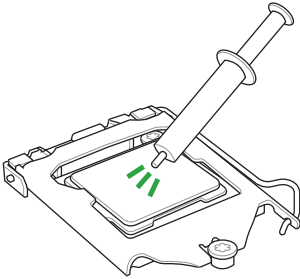

Apply the Thermal Interface Material to the CPU heatsink and CPU before you install the heatsink and fan if necessary.

### To install the CPU heatsink and fan assembly

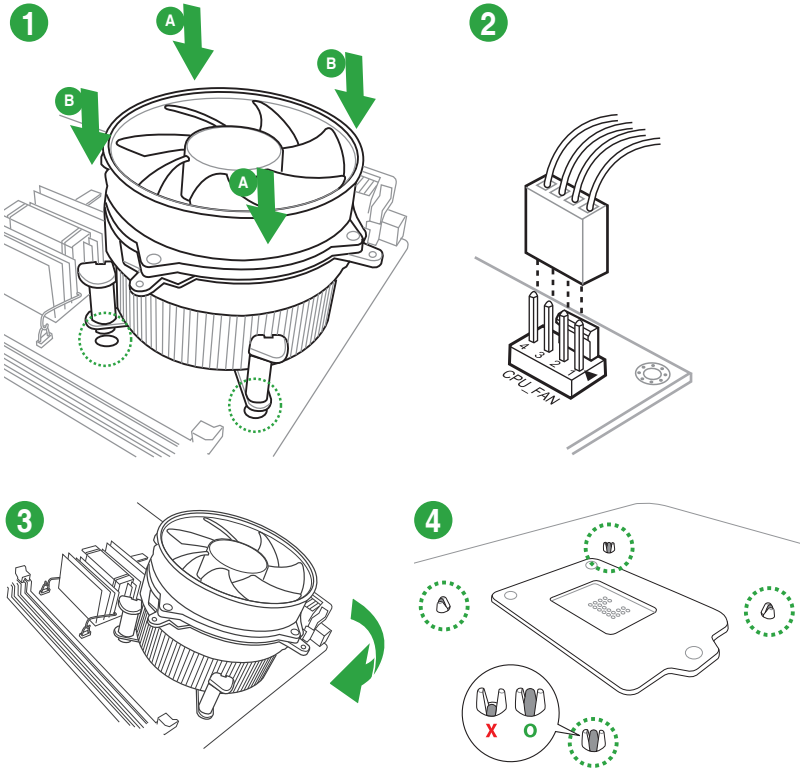

### To uninstall the CPU heatsink and fan assembly

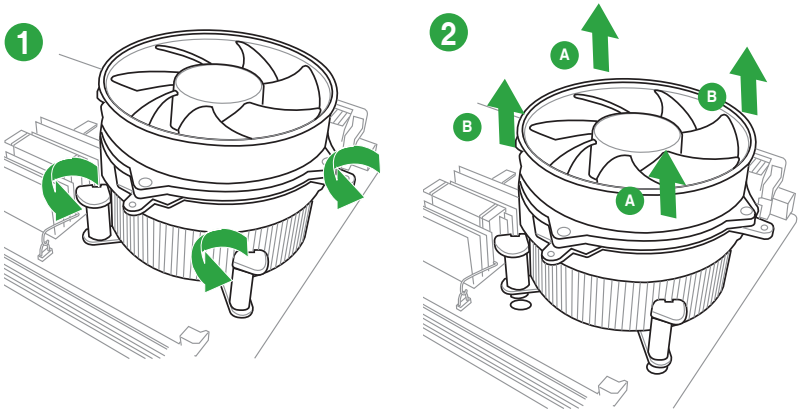



## 1.4 System memory

### 1.4.1 Overview

This motherboard comes with four Double Data Rate 3 (DDR3) Dual Inline Memory Module (DIMM) sockets. A DDR3 module is notched differently from a DDR or DDR2 module. DO NOT install a DDR or DDR2 memory module to the DDR3 slot.



According to Intel® CPU spec, DIMM voltage below 1.65 V is recommended to protect the CPU.

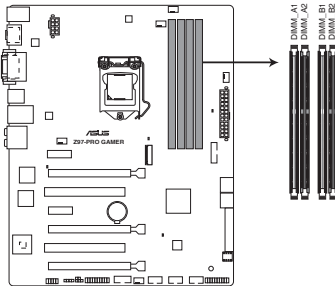

Z97-PRO GAMER 240-pin DDR3 DIMM sockets

### 1.4.2 Memory configurations

You may install 2 GB, 4 GB, and 8 GB unbuffered non-ECC DDR3 DIMMs into the DIMM sockets. You can refer to the recommended memory population below.

#### Recommended memory configurations

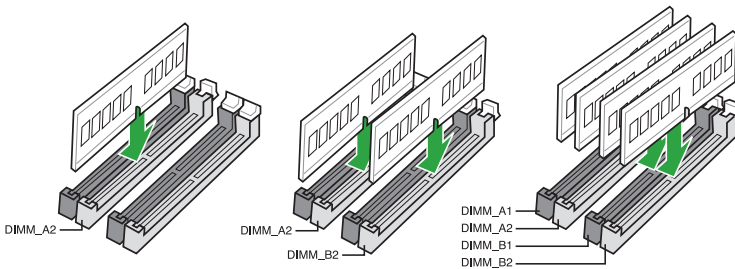



- You may install varying memory sizes in Channel A and Channel B. The system maps the total size of the lower-sized channel for the dual-channel configuration. Any excess memory from the higher-sized channel is then mapped for single-channel operation.
- Always install DIMMs with the same CAS latency. For optimal compatibility, we recommend that you install memory modules of the same version or date code (D/C) from the same vendor. Check with the retailer to get the correct memory modules.
- Due to the memory address limitation on 32-bit Windows® OS, when you install 4GB or more memory on the motherboard, the actual usable memory for the OS can be about 3GB or less. For effective use of memory, we recommend that you do any of the following:
  - Use a maximum of 3 GB system memory if you are using a 32-bit Windows® OS.
  - Install a 64-bit Windows® OS if you want to install 4GB or more on the motherboard.
  - For more details, refer to the Microsoft® support site at <http://support.microsoft.com/kb/929605/en-us>.
- This motherboard does not support DIMMs made up of 512 Mb (64 MB) chips or less.



- The default memory operation frequency is dependent on its Serial Presence Detect (SPD), which is the standard way of accessing information from a memory module. Under the default state, some memory modules for overclocking may operate at a lower frequency than the vendor-marked value. To operate at the vendor-marked or at a higher frequency, refer to section **2.5 Ai Tweaker menu** for manual memory frequency adjustment.
- Memory modules with memory frequency higher than 2133MHz and their corresponding timing or the loaded XMP profile is not the JEDEC memory standard. The stability and compatibility of the memory modules depend on the CPU's capabilities and other installed devices.
- For system stability, use a more efficient memory cooling system to support a full memory load (4 DIMMs).

## Z97-PRO GAMER motherboard memory Qualified Vendors Lists (QVL)

### DDR3 3200 (O.C.) MHz capability

Vendors	Part No.	Size	SS/DS	Chip Brand	Chip NO.	Timing	Voltage	DIMM socket support (Optional)	
								2 DIMMs	4 DIMMs
AVEXIR	AVD3UH32001304G-4CI(XMP)	16GB (4x4GB)	SS	-	-	13-15-15-35	1.65V	•	•
G.SKILL	F3-3200C12Q-16GTXDG(XMP)	16GB (4x4GB)	SS	-	-	12-15-15-35	1.65V	•	•

### DDR3 3100 (O.C.) MHz capability

Vendors	Part No.	Size	SS/DS	Chip Brand	Chip NO.	Timing	Voltage	DIMM socket support (Optional)	
								2 DIMMs	4 DIMMs
AVEXIR	AVD3UH31001204G-4CI(XMP)	16GB (4x4GB)	SS	-	-	12-14-14-35	1.65V	•	•
A-DATA	AX3U3100W4G12-DMV(XMP)	8GB (2x4GB)	SS	-	-	12-14-14-36	1.65V	•	•

## DDR3 3000 (O.C.) MHz capability

Vendors	Part No.	Size	SS/DS	Chip Brand	Chip NO.	Timing	Voltage	DIMM socket support (Optional)	
								2 DIMMs	4 DIMMs
AVEXIR	AVD3UH30001204G-4BZ1(XMP)	16GB (4x4GB)	SS	-	-	12-14-14-35	1.65V	•	•
G.SKILL	F3-3000C12Q-16GTXDG(XMP)	16GB (4x4GB)	SS	-	-	12-14-14-35	1.65V	•	•
G.SKILL	F3-3000C12D-8GTXDG(XMP)	8GB (2x4GB)	SS	-	-	12-14-14-35	1.65V	•	•
CORSAIR	CMY8GX3M2A3000C12R(XMP)	8GB (2x4GB)	SS	-	-	12-14-14-36	1.65V	•	

## DDR3 2933 (O.C.) MHz capability

Vendors	Part No.	Size	SS/DS	Chip Brand	Chip NO.	Timing	Voltage	DIMM socket support (Optional)	
								2 DIMMs	4 DIMMs
AVEXIR	AVD3UH29331204G-4CI(XMP)	16GB (4x4GB)	SS	-	-	12-14-14-35	1.65V	•	•
GEIL	GPW38GB2933C12ADC(XMP)	8GB (2x4GB)	SS	-	-	12-14-14-36	1.65V	•	•
APACER	78.BAGHB.AFL0C(XMP)	8GB (2x4GB)	SS	-	-	12-14-14-35	1.65V	•	•
A_DATA	AX3U2933W4G12(XMP)	16GB (4x4GB)	SS	-	-	12-14-14-36	1.65V	•	•
G.SKILL	F3-2933C12D-8GTXDG(XMP)	8GB (2x4GB)	SS	-	-	12-14-14-35	1.65V	•	•
G.SKILL	F3-2933C12Q-16GTXDG(XMP)	16GB (4x4GB)	SS	-	-	12-14-14-35	1.65V	•	•
CORSAIR	CMY16GX3M4A2933C12R(XMP)	16GB(4 x 4GB)	SS	-	-	12-14-14-36	1.65V	•	•

## DDR3 2800 (O.C.) MHz capability

Vendors	Part No.	Size	SS/DS	Chip Brand	Chip NO.	Timing	Voltage	DIMM socket support (Optional)	
								2 DIMMs	4 DIMMs
AVEXIR	AVD3UH28001208G-4BZ1(XMP)	32GB (4x 8GB)	DS	-	-	12-14-14-35	1.65V	•	•
A_DATA	AX3U2800W4G12(XMP)	16GB (4x 4GB)	SS	-	-	12-14-14-36	1.65V	•	•
A_DATA	AX3U2800W8G12(XMP)	32GB (4x 8GB)	DS	-	-	12-14-14-36	1.65V	•	•
G.SKILL	F3-2800C12Q-32GTXD(XMP)	32GB (4x 8GB)	DS	-	-	12-13-13-35	1.65V	•	•
G.SKILL	F3-2800C12Q-32GTXDG(XMP)	32GB (4x 8GB)	DS	-	-	12-14-14-35	1.65V	•	•
G.SKILL	F3-2800C11Q-16GTXD(XMP)	16GB (4x 4GB)	DS	-	-	11-13-13-35	1.65V	•	•
G.SKILL	F3-2800C11D-8GTXD(XMP)	8GB (2x 4GB)	DS	-	-	11-13-13-35	1.65V	•	•
G.SKILL	F3-2800C11D-8GTXDG(XMP)	8GB (2x 4GB)	DS	-	-	11-14-14-35	1.65V	•	•
G.SKILL	F3-2800C10D-8GTXD(XMP)	8GB (2x 4GB)	DS	-	-	10-12-12-35	1.65V	•	•
G.SKILL	F3-2800C12Q-16GTXDG(XMP)	16GB (4x 4GB)	DS	-	-	12-14-14-35	1.65V	•	•
G.SKILL	F3-2800C11D-16GTXDG(XMP)	16GB (2 x 8GB)	DS	-	-	11-14-14-35	1.65V	•	•
G.SKILL	F3-2800C11Q-32GTXDG(XMP)	32GB (4 x 8GB)	DS	-	-	11-14-14-35	1.65V	•	•
G.SKILL	F3-2800C11D-16GTXD(XMP)	16GB (2x 8GB)	DS	-	-	11-13-13-35	1.65V	•	•
G.SKILL	F3-2800C11Q-32GTXD(XMP)	32GB (4 x 8GB)	DS	-	-	11-13-13-35	1.65V	•	•
G.SKILL	F3-2800C12D-16GTXD(XMP)	16GB (2 x 8GB)	DS	-	-	12-14-14-35	1.65V	•	•
APACER	78.BAGH5.AFD0C(XMP)	8GB (2x 4GB)	DS	-	-	12-14-14-35	1.65V	•	•
APACER	78.CAGH6.AFD0C(XMP)	16GB (2x 8GB)	DS	-	-	12-14-14-35	1.65V	•	•
CORSAIR	CMD16GX3M4A2800C11(XMP)	16GB (4x 4GB)	DS	-	-	11-14-14-35	1.65V	•	•
CORSAIR	CMD16GX3M4A2800C12(XMP)	16GB (4x 4GB)	DS	-	-	12-14-14-36	1.65V	•	•
CORSAIR	CMY16GX3M4A2800C12R(XMP)	16GB (4x 4GB)	SS	-	-	12-14-14-36	1.65V	•	•
KINGSTON	KHX28C12T2K2/8X	8GB (2x 4GB)	SS	-	-	12-14-14-32	1.65V	•	•
Team	TXD38G2800HC12DBK(XMP)	32GB (4 x 8GB)	DS	-	-	11-14-14-35	1.65V	•	•

## DDR3 2666 (O.C.) MHz capability

Vendors	Part No.	Size	SS/DS	Chip Brand	Chip NO.	Timing	Voltage	DIMM socket support (Optional)		
								1 DIMM	2 DIMMs	4 DIMMs
Apacer	78.BAGFF.AFC0C(XMP)	8GB (2x4GB)	DS	-	-	12-13-13-35	-	•	•	•
Apacer	78.BAGFR.AFD0C(XMP)	8GB (2x4GB)	DS	-	-	12-13-13-35	-	•	•	•
Apacer	78.CAGFF.AFD0C(XMP)	16GB (2x8GB)	DS	-	-	12-13-13-35	-	•	•	•
CORSAIR	CMD16GX3M4A2666C11 (Ver5.12)(XMP)	16GB (4x4GB)	DS	-	-	11-13-13-35	1.65V	•	•	•
G.SKILL	F3-2666CL10Q-16GBZHD(XMP)	16GB (4x4GB)	DS	-	-	10-12-12-31	1.65V	•	•	•
GEIL	GOC32GB2666C11QC(XMP)	32GB (4x8GB)	DS	-	-	11-13-13-32	1.65V	•	•	•
KINGSTON	KHX26C11T2K2/8X(XMP)	8GB (2x4GB)	SS	-	-	11-13-13-32	1.65V	•	•	•

## DDR3 2400 (O.C.) MHz capability

Vendors	Part No.	Size	SS/DS	Chip Brand	Chip NO.	Timing	Voltage	DIMM socket support (Optional)		
								1 DIMM	2 DIMMs	4 DIMMs
A-DATA	AX3U2400W4G11-DMV(XMP)	8GB ( 2x 4GB )	SS	-	-	11-13-13-35	1.65V	•	•	•
A-DATA	AX3U2400W8G11-DMV(XMP)	16GB ( 2x 8GB )	DS	-	-	11-13-13-35	1.65V	•	•	•
Apacer	78.BAGFL.AFD0C(XMP)	8GB ( 2x 4GB )	DS	-	-	11-12-12-30	-	•	•	•
Apacer	783BAGF3.AFD0C(XMP)	8GB ( 2x 4GB )	DS	-	-	11-11-11-30	-	•	•	•
CORSAIR	CMD16GX3M2A2400C10 (Ver4.21)(XMP)	16GB ( 2x 8GB )	DS	-	-	10-12-12-31	1.65V	•	•	•
CORSAIR	CMD32GX3M4A2400C10 (Ver5.29)(XMP)	32GB ( 4x 8GB )	DS	-	-	10-12-12-31	1.65V	•	•	•
CORSAIR	CMY16GX3M2A2400C10A (Ver4.21)(XMP)	16GB ( 8x 2GB )	DS	-	-	10-12-12-31	1.65V	•	•	•
CORSAIR	CMY16GX3M2A2400C10R (Ver4.21)(XMP)	16GB ( 2x 8GB )	DS	-	-	10-12-12-31	1.65V	•	•	•
CORSAIR	CMZ16GX3M2A2400C10 (Ver4.21)	16GB ( 2x 8GB )	DS	-	-	10-12-12-31	1.65V	•	•	•
G.SKILL	F3-19200CL10Q2-64GBZHD(XMP)	64GB ( 8x 8GB )	DS	-	-	10-12-12-31	1.65V	•	•	•
G.SKILL	F3-19200CL10Q-32GBZHD(XMP)	32GB ( 4x 8GB )	DS	-	-	10-12-12-31	1.65V	•	•	•
G.SKILL	F3-19200CL11Q-16GBZHD(XMP)	16GB ( 4x 4GB )	DS	-	-	11-11-11-31	1.65V	•	•	•
G.SKILL	F3-19200CL9D-4GBPIS(XMP)	4G ( 2x 2G )	DS	-	-	9-11-9-28	1.65V	•	•	•
G.SKILL	F3-19200CL9Q-16GBZMD(XMP)	16GB ( 4x 4GB )	DS	-	-	9-11-11-31	1.65V	•	•	•
G.SKILL	F3-2400C11Q-32GX(M)(XMP)	32GB ( 4x 8GB )	DS	-	-	11-13-13-31	1.65V	•	•	•
GEIL	GOC316GB2400C10QC(XMP)	16GB ( 4x 4GB )	DS	-	-	10-11-11-30	1.65V	•	•	•
GEIL	GOC316GB2400C11QC(XMP)	16GB ( 4x 4GB )	DS	-	-	11-11-11-30	1.65V	•	•	•
Kingston	KHX2400C11D3K4/8GX(XMP)	8GB ( 4x 2GB )	SS	-	-	11-13-11-30	1.65V	•	•	•
KINGSTON	KHX24C11K4/16X(XMP)	16GB ( 4x 4GB )	DS	-	-	11-13-13-30	1.65V	•	•	•
KINGSTON	KHX24C11T2K2/8X(XMP)	8GB ( 2x 4GB )	DS	-	-	-	1.65V	•	•	•
KINGSTON	KHX24C11T3K2/16X(XMP)	16GB ( 2x 8GB )	DS	-	-	11-13-13-32	1.65V	•	•	•
KINGSTON	KHX24C11T3K4(XMP)	16GB ( 4x 4GB )	DS	-	-	11-13-13-30	1.65V	•	•	•
KINGSTON	KHX24C11T3K4/32X(XMP)	32GB ( 4x 8GB )	DS	-	-	9-9-9-24	1.65V	•	•	•
Mushkin	997122R(XMP)	16GB ( 2x 8GB )	DS	-	-	10-12-12-28	1.65V	•	•	•
Silicon Power	SP004GLYU240NSA(XMP)	4GB	SS	-	-	11-13-13-32	-	•	•	•
Transcend	TX2400KLN-8GK(XMP)	8GB ( 2x 4GB )	DS	-	-	11-12-11-29	1.6V	•	•	•

## DDR3 2133 (O.C.) MHz capability

Vendors	Part No.	Size	SS/DS	Chip Brand	Chip NO.	Timing	Voltage	DIMM socket support (Optional)		
								1 DIMM	2 DIMMs	4 DIMMs
A-DATA	AX3U2133W4G10-DR(XMP)	8GB ( 2x 4GB )	SS	-	-	10-11-11-30	1.65V	•	•	•
A-DATA	AX3U2133W8G10-DR(XMP)	16GB ( 2x 8GB )	DS	-	-	10-11-11-30	1.65V	•	•	•
Apacer	78.BAGE4.AFD0C(XMP)	8GB ( 2x 4GB )	DS	-	-	9-9-9-24	-	•	•	•
Apacer	AHU04GFB33CAQ3R(XMP)	4GB	DS	-	-	11-13-13-31	-	•	•	•
CORSAIR	CMD16GX3M2A2133C9 (Ver4.21)(XMP)	16GB ( 2x 8GB )	DS	-	-	9-11-11-31	1.65V	•	•	•
CORSAIR	CMD32GX3M4A2133C9 (Ver4.21)(XMP)	32GB ( 4x 8GB )	DS	-	-	9-11-11-31	1.65V	•	•	•
CORSAIR	CMD8GX3M2A2133C9 (Ver1.5)(XMP)	8GB ( 2x 4GB )	DS	-	-	9-11-10-27	1.5V	•	•	
CORSAIR	CMD8GX3M2B2133C9 (Ver5.12)(XMP)	8GB ( 2x 4GB )	DS	-	-	9-11-11-31	1.65V	•	•	•
CORSAIR	CMY8GX3M2A2133C11R (Ver4.21)(XMP)	8GB ( 2x 4GB )	DS	-	-	11-11-11-27	1.5V	•	•	•
CORSAIR	CMZ8GX3M2A2133C11R (Ver4.21)(XMP)	8GB ( 2x 4GB )	DS	-	-	11-11-11-27	1.5V	•	•	•
G.SKILL	F3-17000CL11Q2-64GBZLD(XMP)	64GB ( 8x 8GB )	DS	-	-	11-11-11-30	1.5V	•	•	•
G.SKILL	F3-17000CL9Q-16GBZH(XMP)	16GB ( 4x 4GB )	DS	-	-	9-11-10-28	1.65V	•	•	•
G.SKILL	F3-2133C10Q-32GSR(XMP)	32GB ( 4x 8GB )	DS	-	-	10-12-12-31	1.5V	•	•	•
G.SKILL	F3-2133C11Q-32GZL(XMP)	32GB ( 4x 8GB )	DS	-	-	11-11-11-31	1.5V	•	•	•
KINGSTON	KHX2133C11D3K4/16GX(XMP)	16GB ( 4x 4GB )	DS	-	-	11-12-11-30	1.65V	•	•	•
KINGSTON	KHX21C11T3FK8/64X(XMP)	64GB ( 8x 8GB )	DS	-	-	9-9-9-24	1.5V	•	•	•
Silicon Power	SP004GXLYU213NSA(XMP)	4GB	SS	-	-	11-12-11-30	-	•	•	•
Silicon Power	SP008GXLYU213NSA(XMP)	8GB	DS	-	-	11-12-11-30	-	•	•	•
Transcend	TX2133KLN-16GK(XMP)	16GB ( 2x 8GB )	DS	-	-	10-11-10-27	1.6V	•	•	•
Transcend	TX2133KLN-8GK(XMP)	8GB ( 2x 4GB )	DS	-	-	10-11-10-27	1.6V	•	•	•

## DDR3 2000 (O.C.) MHz capability

Vendors	Part No.	Size	SS/DS	Chip Brand	Chip NO.	Timing	Voltage	DIMM socket support (Optional)		
								1 DIMM	2 DIMMs	4 DIMMs
AEXEA	AXA3ES4GK2000LG28V(XMP)	4GB (2x2GB)	DS	-	-	-	1.65V	•	•	•
Asint	SLA302G08-ML2HB(XMP)	4GB	DS	Hynix	H5TQ2G83BFRH9C	9-9-9-27	-	•	•	•
GEIL	GUP34GB2000C9DC(XMP)	4GB (2x2GB)	DS	-	-	9-9-9-28	1.65V	•	•	•

## DDR3 1866 (O.C.) MHz capability

Vendors	Part No.	Size	SS/DS	Chip Brand	Chip NO.	Timing	Voltage	DIMM socket support (Optional)		
								1 DIMM	2 DIMMs	4 DIMMs
CORSAIR	CMD16GX3M2A1866C9 (Ver5.29)(XMP)	16GB (2x 8GB)	DS	-	-	9-9-9-27	1.5	•	•	
CORSAIR	CMD16GX3M4A1866C9 (Ver4.13)(XMP)	16GB (4x 4GB)	DS	-	-	9-10-9-27	1.5	•	•	•
CORSAIR	CMD16GX3M4A1866C9 (Ver8.16)(XMP)	16GB (4x 4GB)	DS	-	-	9-10-9-27	1.5	•	•	•
CORSAIR	CMD32GX3M4A1866C9 (Ver3.24)(XMP)	32GB (4x 8GB)	DS	-	-	9-10-9-27	1.5	•	•	•
CORSAIR	CMD8GX3M2A1866C9 (Ver4.13)(XMP)	8GB (2x 4GB)	DS	-	-	-	1.5	•	•	•
CORSAIR	CMD8GX3M2A1866C9 (Ver5.12)(XMP)	8GB (2x 4GB)	DS	-	-	9-10-9-27	1.5	•	•	
CORSAIR	CMD8GX3M2A1866C9 (Ver8.16)(XMP)	8GB (2x 4GB)	DS	-	-	9-10-9-27	1.5	•	•	
CORSAIR	CMT32GX3M4X1866C9(Ver3.23)(XMP)	32GB (4x 8GB)	DS	-	-	9-10-9-27	1.5	•	•	•
CORSAIR	CMY16GX3M2A1866C9 (Ver 4.21)(XMP)	16GB (2x 8GB)	DS	-	-	9-10-9-27	1.5	•	•	•
CORSAIR	CMY8GX3M2A1866C9 (Ver3.24)(XMP)	8GB (2x 4GB)	DS	-	-	9-10-9-27	1.5	•	•	•
CORSAIR	CMZ16GX3M2A1866C10 (Ver5.29)(XMP)	16GB (2x 8GB)	DS	-	-	10-11-10-30	1.5	•	•	•
CORSAIR	CMZ16GX3M2A1866C9(XMP)	16GB (2x 8GB)	DS	-	-	9-10-9-27	1.5	•	•	•
CORSAIR	CMZ32GX3M4X1866C10 (Ver3.23)(XMP)	32GB (4x 8GB)	DS	-	-	10-11-10-27	1.5	•	•	•
CORSAIR	CMZ32GX3M4X1866C10(Ver3.23)(XMP)	32GB (4x 8GB)	DS	-	-	10-11-10-27	1.5	•	•	•
CORSAIR	CMZ8GX3M2A1866C9 (Ver8.16)(XMP)	8GB (2x 4GB)	DS	-	-	9-10-9-27	1.5	•	•	•
CORSAIR	CMZ8GX3M2A1866C9(XMP)	8GB (2x 4GB)	DS	-	-	9-10-9-27	1.5	•	•	•
CORSAIR	CMZ8GX3M2A1866C9G (Ver5.12)(XMP)	8GB (2x 4GB)	DS	-	-	9-10-9-27	1.5	•	•	•
Crucial	BLE8G3D1869DE1TX0.16FED(XMP)	16GB (2x 8GB)	DS	-	-	9-9-9-27	1.5	•	•	•
Crucial	BLE4G3D1869DE1XT0.16FMD(XMP)	4GB	DS	-	-	9-9-9-27	1.5	•	•	•
G.SKILL	F3-14900CL10Q-32GBZL(XMP)	32GB (4x 8GB)	DS	-	-	10-11-10-30	1.5	•	•	•
G.SKILL	F3-14900CL9D-8GBSR(XMP)	8GB (2x 4GB)	DS	-	-	9-10-9-28	1.5	•	•	•
G.SKILL	F3-14900CL9Q-16GBXL(XMP)	16GB (4x 4GB)	DS	-	-	9-10-9-28	1.5	•	•	•
G.SKILL	F3-14900CL9Q-16GBZL(XMP)	16GB (4x 4GB)	DS	-	-	9-10-9-28	1.5	•	•	•
G.SKILL	F3-14900CL9Q-16GBZL(XMP)	16GB (4x 4GB)	DS	-	-	9-10-9-28	1.5	•	•	•
G.SKILL	F3-1866C10Q2-64GZM(XMP)	64GB (2x 8GB)	DS	-	-	10-11-10-30	1.5	•	•	•
G.SKILL	F3-1866C10Q2-64GZM(XMP)	64GB (2x 8GB)	DS	-	-	10-11-10-30	1.5	•	•	•
G.SKILL	F3-1866C9Q-32GXM(XMP)	32GB (4x 8GB)	DS	-	-	9-10-9-28	1.5	•	•	•
GEIL	GEEL316GB1866C9DC(XMP)	16GB (2x 8GB)	DS	-	-	9-10-9-28	1.65	•	•	•
KINGSTON	KHX1866C9D3K2/8GX(XMP)	8GB (2x 4GB)	DS	-	-	-	1.65	•	•	•
Silicon Power	SP004GXYU186NSA(XMP)	4GB	SS	-	-	9-11-9-27	-	•	•	•
Silicon Power	SP008GXYU186NSA(XMP)	8GB	DS	-	-	9-11-9-27	-	•	•	•

## DDR3 1600 MHz capability

Vendors	Part No.	Size	SS/DS	Chip Brand	Chip NO.	Timing	Voltage	DIMM socket support (Optional)		
								1 DIMM	2 DIMMs	4 DIMMs
A-DATA	AD3U1600W4G11	4GB	SS	A-DATA	3WCD-1211A	11-11-11-28	-	•	•	•
A-DATA	AD3U1600W8G11	8GB	DS	A-DATA	3WCD-1211A	11-11-11-28	-	•	•	•
A-DATA	ADDU1600W4G11-B	4GB	SS	A-DATA	DWND-1211A	9-9-9-24	-	•	•	•
A-DATA	ADDU1600W8G11-B	8GB	DS	ELPIDA	J4208EBBG-GN-F	9-9-9-24	-	•	•	•
A-DATA	AX3U1600W4G9-DB(XMP)	8GB ( 2x 4GB)	SS	-	-	9-9-9-24	1.5	•	•	•
A-DATA	AX3U1600W8G9-DB(XMP)	16GB (2x 8GB)	DS	-	-	9-9-9-24	1.5	•	•	•
AMD	AE32G1609U1-U	2GB	SS	AMD	23EY4587MB6H	-	1.5	•	•	•
AMD	AE34G1609U2-U	4GB	DS	AMD	23EY4587MB6H	-	1.5	•	•	•
AMD	AP38G1608U2K(XMP)	8GB ( 2x 4GB)	DS	-	-	9-9-9-28	1.65	•	•	•
Apacer	78.B1GE3.9L10C	4GB	DS	Apacer	AM5D5908DEQSCCK	-	1.65	•	•	•
Apacer	78.B1GET.9K00C	4GB	SS	Apacer	AM5D6008BQQSCCK	11-11-11-28	-	•	•	•
Apacer	78.C1GET.9K10C	8GB	DS	Apacer	AM5D6008BQQSCCK	11-11-11-31	-	•	•	•
Apacer	AHU04GFA60C9Q3R(XMP)	4GB	DS	-	-	11-11-11-28	-	•	•	•
Apacer	AHU08GFA60CBT3R(XMP)	8GB	DS	-	-	9-9-9-24	-	•	•	•
Asint	SLA302G08-EGG1C(XMP)	4GB	DS	Asint	302G08-GG1C	9-9-9-27	-	•	•	•
Asint	SLA302G08-EGJ1C(XMP)	4GB	DS	Asint	302G08-GJ1C	9-9-9-27	-	•	•	•
Asint	SLA302G08-EGN1C	4GB	DS	ASint	302G08-GN1C	-	-	•	•	•
Asint	SLA304G08-ENG1B	4GB	SS	Asint	304G08-GN1B	9-11-11-28	-	•	•	•
Asint	SLB304G08-EGJ1B(XMP)	8GB	DS	-	-	9-9-9-27	-	•	•	•
Asint	SLB304G08-EGN1B	8GB	DS	ASint	304G08-GN1B	-	-	•	•	•
Asint	SLZ302G08-EGN1C	2GB	SS	ASint	302G08-GN1C	-	-	•	•	•
AVEXIR	AVD3U16000904G-2CW(XMP)	8GB ( 2x 4GB)	DS	-	-	11-11-11-28	1.5	•	•	•
CORSAIR	CMD16GX3M2A1600C9 (Ver8.21)(XMP)	16GB ( 2x 8GB)	DS	-	-	9-9-9-24	1.5	•	•	•
CORSAIR	CMD8GX3M2A1600C8 (Ver5.12)(XMP)	8GB ( 2x 4GB)	DS	-	-	1600 8-8-8-24	1.5	•	•	•
CORSAIR	CMD8GX3M2A1600C9 (Ver2.12)(XMP)	8GB ( 2x 4GB)	DS	-	-	9-9-9-24	1.5	•	•	•
CORSAIR	CML16GX3M2A1600C10 (Ver2.21)(XMP)	16GB ( 2x 8GB)	DS	-	-	10-10-10-27	1.5	•	•	•
CORSAIR	CML8GX3M2A1600C9 (Ver7.12)(XMP)	8GB ( 2x 4GB)	DS	-	-	9-9-9-24	1.5	•	•	•
CORSAIR	CMV8GX3M1A1600C11	8GB	DS	-	-	11-11-11-30	-	•	•	•
CORSAIR	CMX8GX3M2A1600C9 (Ver3.19)(XMP)	8GB ( 2x 4GB)	SS	-	-	9-9-9-24	1.65	•	•	•
CORSAIR	CMZ16GX3M2A1600C10 (Ver.3.24)(XMP)	16GB ( 2x 8GB)	DS	-	-	10-10-10-27	1.5	•	•	•
CORSAIR	CMZ16GX3M4A1600C9(XMP)	16GB ( 4x 4GB)	DS	-	-	9-9-9-24	1.5	•	•	•
CORSAIR	CMZ16GX3M4X1600C9 (Ver8.16)(XMP)	16GB ( 4x 4GB)	DS	-	-	9-9-9-24	1.5	•	•	•
CORSAIR	CMZ32GX3M4X1600C10 (Ver2.2)(XMP)	32GB ( 4x 8GB)	DS	-	-	10-10-10-27	1.5	•	•	•
CORSAIR	CMZ4GX3M1A1600C9 (Ver8.16)(XMP)	4GB ( 1x 4GB)	DS	-	-	9-9-9-24	1.5	•	•	•
CORSAIR	CMZ8GX3M1A1600C10 (Ver3.23)(XMP)	8GB ( 1x 8GB)	DS	-	-	10-10-10-27	1.5	•	•	•
CORSAIR	CMZ8GX3M1A1600C10 (Ver8.21)(XMP)	8GB ( 1x 8GB)	DS	-	-	10-10-10-27	1.5	•	•	•
CORSAIR	CMZ8GX3M2A1600C8(XMP)	8GB ( 2x 4GB)	DS	-	-	8-8-8-24	1.5	•	•	•

(continued on the next page)

## DDR3 1600 MHz capability

Vendors	Part No.	Size	SS/ DS	Chip Brand	Chip NO.	Timing	Voltage	DIMM socket support (Optional)		
								1 DIMM	2 DIMMs	4 DIMMs
Crucial	BLS4G3D1609DS1S00.16FMR (XMP)	4GB	DS	-	-	9-9-9-24	1.5	*	*	*
Crucial	BLT4G3D1608DT1TX0.16FM (XMP)	4GB	DS	-	-	8-8-8-24	1.5	*	*	*
Elixir	M2X2G64CB88G7N-DG(XMP)	2GB	SS	Elixir	N2CB2G80GN-DG	9-9-9-28	-	*	*	*
Elixir	M2X4G64CB88G5N-DG(XMP)	4GB	DS	Elixir	N2CB2G80GN-DG	9-9-9-28	-	*	*	*
G.SKILL	F3-12800CL9D-8GBSR2(XMP)	8GB (2x 4GB)	DS	-	-	9-9-9-24	1.25	*	*	*
G.SKILL	F3-12800CL9Q-16GBXL(XMP)	16GB (4x 4GB)	DS	-	-	9-9-9-24	1.5	*	*	*
G.Skill	F3-12800CL9Q-16GBZL(XMP)	16GB (4x 4GB)	DS	-	-	9-9-9-24	1.5	*	*	*
G.SKILL	F3-1600C9Q-32GX(XMP)	32GB (4x 8GB)	DS	-	-	-	1.5	*	*	*
GEIL	GUP34GB1600C7DC(XMP)	4GB (2x 2GB)	DS	-	-	7-7-7-24	1.6	*	*	*
KINGMAX	FLGE85F-C8KL9A(XMP)	2GB	SS	KINGMAX	N/A	9-9-9-28	-	*	*	*
KINGMAX	FLGF65F-C8KL9A(XMP)	4GB	DS	KINGMAX	N/A	9-9-9-28	-	*	*	*
KINGSTON	KHX16009CD3K2/8GX(XMP)	8GB (2x 4GB)	DS	-	-	9-9-9-27	1.65	*	*	*
KINGSTON	KHX1600C9D3B1/4G(XMP)	4GB	SS	-	-	9-9-9-27	1.65	*	*	*
KINGSTON	KHX1600C9D3K3/12GX(XMP)	12GB (3x 4GB)	DS	-	-	9	1.65	*	*	*
KINGSTON	KHX1600C9D3K3/6GX(XMP)	6GB (3x 2GB)	DS	-	-	9	1.65	*	*	*
KINGSTON	KHX1600C9D3K3/6GX(XMP)	6GB (3x 2GB)	DS	-	-	9	1.65	*	*	*
KINGSTON	KHX1600C9D3K4/16GX(XMP)	16GB (4x 4GB)	DS	-	-	9-9-9-24	1.65	*	*	*
KINGSTON	KHX1600C9D3K6/24GX(XMP)	24GB (6x 4GB)	DS	-	-	9	1.65	*	*	*
KINGSTON	KHX1600C9D3LK2/8GX(XMP)	8GB (2x 4GB)	DS	-	-	9-9-9-24	1.35	*	*	*
KINGSTON	KHX1600C9D3P1K2/8G	8GB (2x 4GB)	DS	-	-	9	1.5	*	*	*
KINGSTON	KHX16C10B1K2/16X(XMP)	16GB (2x 8GB)	DS	-	-	-	1.5	*	*	*
KINGSTON	KHX16C9K2/16	16GB (2x 8GB)	DS	-	-	1333-9-9-9-24	1.5	*	*	*
KINGSTON	KHX16C9P1K2/16	16GB (2x 8GB)	DS	-	-	-	1.5	*	*	*
KINGSTON	KVR16N11/4	4GB	DS	KINGSTON	D2568JPUCCPGGBU	11-11-11-28-1	-	*	*	*
KINGSTON	KVR16N11/4	4G	DS	Hynix	H5TQ2G83CFRFBPC	-	1.5	*	*	*
Micron	MT16JTF1G64AZ-1G6E1	8GB	DS	Micron	D9QBJ	-	-	*	*	*
Micron	MT8JTF51264AZ-1G6E1	4GB	SS	Micron	D9QBJ	-	-	*	*	*
MICRON	MT8KTF25664AZ-1G6M1	2GB	SS	MICRON	D9PFJ	-	-	*	*	*
Patriot	PV316G160C9K(XMP)	16GB (2x 4GB)	SS	-	-	9-9-9-24	1.5	*	*	*
Patriot	PV316G160C9K(XMP)	16GB (2x 8GB)	SS	-	-	9-9-9-24	1.5	*	*	*
SanMax	SMD-4G28N1P-16KM	4GB	SS	ELPIDA	J4208BBBG-GN-F	1600	-	*	*	*
SanMax	SMD-4G68HP-16KZ	4GB	DS	Hynix	H5TQ2G83BFRFBPC	-	1.5	*	*	*
SanMax	SMD-4G68NG-16KK	4GB	DS	ELPIDA	J2108BDBG-GN-F	-	-	*	*	*
SanMax	SMD-8G28NP-16KM	8GB	DS	ELPIDA	J4208BBBG-GN-F	1600	-	*	*	*
Silicon Power	SP002GBLTU160V02(XMP)	2GB	SS	S-POWER	20YT5NG	9-11-11-28	1.5	*	*	*

(continued on the next page)



## DDR3 1600 MHz capability

Vendors	Part No.	Size	SS/DS	Chip Brand	Chip NO.	Timing	Voltage	DIMM socket support (Optional)		
								1 DIMM	2 DIMMs	4 DIMMs
Silicon Power	SP004GBLTU160V02(XMP)	4GB	DS	S-POWER	20YT5NG	9-9-9-24	1.5	*	*	*
Silicon Power	SP004GXLYU160NSA(XMP)	4GB	SS	-	-	9-9-9-27	-	*	*	*
Silicon Power	SP008GXLYU160NSA(XMP)	8GB	DS	-	-	9-9-9-27	-	*	*	*
Team	TED34GM1600C11BK	4GB	DS	Hynix	H5TC2G83EFR	11-11-11-28	1.5	*	*	*
Team	TED38GM1600C11BK	8GB	DS	Hynix	H5TQ4G83AFR	11-11-11-28	1.5	*	*	*
Team	TLD34G1600HC9BK(XMP)	8GB ( 2x 4GB )	DS	-	-	9-9-9-24	1.5	*	*	*
Team	TLD38G1600HC9BK(XMP)	16GB ( 2x 8GB )	DS	-	-	9-9-9-24	1.5	*	*	*
Team	TXD34096M1600HC9-D(XMP)	4GB	DS	Hynix	H5TC2G83BFRH9A	9-9-9-24	1.5	*	*	*
Transcend	TS1GLK64V6H(620945)	8GB	DS	SAMSUNG	K4B4G0846B	-	-	*	*	*
Transcend	TS1GLK64W6H	8GB	DS	SAMSUNG	K4B4G0846B	11-11-11-28-1	-	*	*	*
Transcend	TS512MLK64W6H	4GB	SS	SAMSUNG	K4B4G0846B	11-11-11-28-2	-	*	*	*
UMAX	84E44G93UM-16BPSYW	4GB	SS	UMAX	U2S96D30TP-16	11-11-11-28	-	*	*	*
UMAX	84E48G93UM-16BPSYW	8GB	DS	UMAX	U2S96D30TP-16	11-11-11-28	-	*	*	*

## DDR3 1333 MHz capability

Vendors	Part No.	Size	SS/DS	Chip Brand	Chip NO.	Timing	Voltage	DIMM socket support (Optional)		
								1 DIMM	2 DIMMs	4 DIMMs
AMD	AE32G1339U1-U	2GB	SS	AMD	23EY4587MB3H	-	1.5	*	*	*
AMD	AE34G1339U2-U	4GB	DS	AMD	23EY4587MB3H	-	1.5	*	*	*
Apacer	78.B1GD.E.9L10C	4GB	DS	Apacer	AM5D5908CEHSBG	9	-	*	*	*
Asint	SLA302G08-EDJ1C	2GB	SS	Asint	302G08-DJ1C	-	-	*	*	*
Asint	SLA304G08-EDJ1B	4GB	SS	Asint	304G08-DJ1B	9-10-10-26	-	*	*	*
Asint	SLB304G08-EDJ1B	8GB	DS	Asint	304G08-DJ1B	9-9-9-24	-	*	*	*
BUFFALO	D3U1333-1G	1GB	SS	Elpida	J1108BFBG-DJ-F	-	-	*	*	*
BUFFALO	D3U1333-2G	2GB	DS	Elpida	J1108BFBG-DJ-F	-	-	*	*	*
BUFFALO	D3U1333-4G	4GB	DS	NANYA	NT5CB256M8BN-CG	-	-	*	*	*
CORSAIR	CMV8GX3M1A1333C9	8GB	DS	-	-	9-9-9-24	-	*	*	*
CORSAIR	CMV8GX3M2A1333C9	8GB ( 2x 4GB )	DS	-	N/A	9-9-9-24	-	*	*	*
CORSAIR	CMX4GX3M1A1333C9 (Ver2.12)	4GB ( 1x 4GB )	DS	-	-	9-9-9-24	1.5	*	*	*
CORSAIR	CMX4GX3M1A1333C9 (Ver5.11)	4GB ( 1x 4GB )	DS	-	-	9-9-9-24	1.5	*	*	*
CORSAIR	CMX8GX3M1A1333C9 (Ver2.2)	8GB	DS	-	-	9-9-9-24	1.5	*	*	*
CORSAIR	CMX8GX3M2A1333C9(XMP)	8GB ( 2x 4GB )	DS	-	-	9-9-9-24	1.5	*	*	*
G.SKILL	F3-10666CL9D-8GBXL	8GB ( 2x 4GB )	DS	-	-	9-9-9-24	1.5	*	*	*
GEIL	GG34GB1333C9DC	4GB ( 2x 2GB )	DS	GEIL	GL1L128M88BA15B	9-9-9-24	1.3	*	*	*
GEIL	GVP34GB1333C9DC	4GB ( 2x 2GB )	DS	-	-	9-9-9-24	1.5	*	*	*
GEIL	GVP38GB1333C9DC	8GB ( 2x 4GB )	DS	-	-	9-9-9-24	1.5	*	*	*

(continued on the next page)

## DDR3 1333 MHz capability

Vendors	Part No.	Size	SS/ DS	Chip Brand	Chip NO.	Timing	Voltage	DIMM socket support (Optional)		
								1 DIMM	2 DIMMs	4 DIMMs
INNODISK	M3UN-2GHJBC09	2GB	SS	Hynix	H5TQ2G83CFRH9C	9-9-9-24	-	*	*	*
INNODISK	M3UN-4GHJAC09	4GB	DS	Hynix	H5TQ2G83CFRH9C	9-9-9-24	-	*	*	*
KINGMAX	FLFE85F-C8KL9	2GB	SS	KINGMAX	KFC8FNLBF-GXX-12A	-	-	*	*	*
KINGMAX	FLFE85F-C8KL9	2GB	SS	KINGMAX	KFC8FNLXF-DXX-15A	-	-	*	*	*
KINGMAX	FLFF65F-C8KL9	4GB	DS	KINGMAX	KFC8FNLXF-DXX-15A	-	-	*	*	*
KINGSTON	KVR1333D3E9S/4G	4GB	DS	Elpida	J2108ECSE-DJ-F	9	1.5	*	*	*
KINGSTON	KVR1333D3N9H/4G	4GB	DS	ELPIDA	J2108BDBG-GN-F	-	1.5	*	*	*
KINGSTON	KVR13N9S8H/4	4GB	SS	ELPIDA	J4208BBBG-GN-F	-	1.5	*	*	*
Mach Xtreme	MXD3U133316GQ	16GB(4x 4GB)	DS	-	-	-	-	*	*	*
Mach Xtreme	MXD3V13332GS	2GB	SS	Mach Xtreme	C2S46D30-D313	-	-	*	*	*
MICRON	MT8JTF25664AZ-1G4M1	2GB	SS	MICRON	D9PFJ	-	-	*	*	*
Patriot	PSD32G13332	2GB	DS	Patriot	PM128M8D3BU-15	9	-	*	*	*
RiDATA	C304627CB1AG22Fe	2GB	DS	RiDATA	C304627CB1AG22Fe	9	-	*	*	*
RiDATA	E304459CB1AG32Cf	4GB	DS	RiDATA	E304459CB1AG32Cf	9	-	*	*	*
Silicon Power	SP001GBLTU133S02	1GB	SS	S-POWER	10YT3E5	9	-	*	*	*
Silicon Power	SP002GBLTU133V02	2GB	SS	S-POWER	20YT3NG	9-9-9-24	-	*	*	*
Silicon Power	SP004GBLTU133V02	4GB	DS	S-POWER	20YT3NG	9-9-9-24	-	*	*	*
UMAX	84E44G93UM-13BPSYW	4GB	SS	UMAX	U2S96D30TP-13	1333-9-9-9-24	-	*	*	*
UMAX	84E48G93UM-13BPSYW	8GB	DS	UMAX	U2S96D30TP-13	1333-9-9-9-24	-	*	*	*



- **SS:** Single-sided / **DS:** Double-sided

### DIMM support:

- **2 DIMMs:** Supports two (2) modules inserted into either the black slots or the gray slots as one pair of Dual-channel memory configuration.
- **4 DIMMs:** Supports four (4) modules inserted into both the gray and black slots as two pairs of Dual-channel memory configuration
- Visit the ASUS website at [www.asus.com](http://www.asus.com) for the latest QVL.

### 1.4.3 Installing a DIMM

1

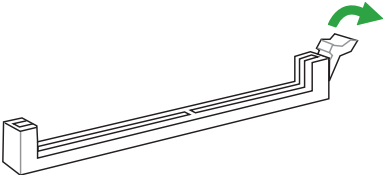

2

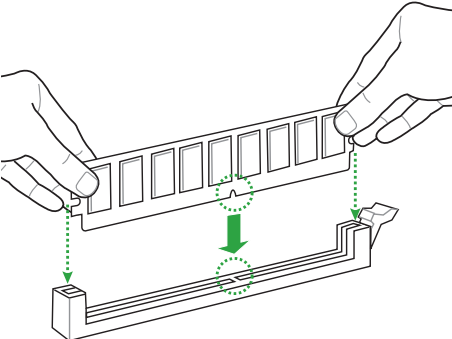

3

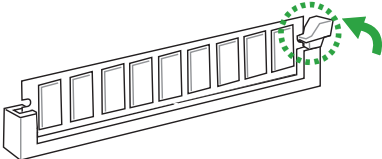

To remove a DIMM

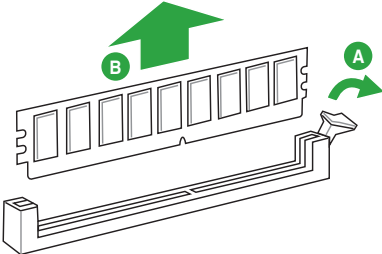

## 1.5 Expansion slots

In the future, you may need to install expansion cards. The following sub-sections describe the slots and the expansion cards that they support.



---

Unplug the power cord before adding or removing expansion cards. Failure to do so may cause you physical injury and damage motherboard components.

---

### 1.5.1 Installing an expansion card

**To install an expansion card:**

1. Before installing the expansion card, read the documentation that came with it and make the necessary hardware settings for the card.
2. Remove the system unit cover (if your motherboard is already installed in a chassis).
3. Remove the bracket opposite the slot that you intend to use. Keep the screw for later use.
4. Align the card connector with the slot and press firmly until the card is completely seated on the slot.
5. Secure the card to the chassis with the screw you removed earlier.
6. Replace the system cover.

### 1.5.2 Configuring an expansion card

After installing the expansion card, configure it by adjusting the software settings.

1. Turn on the system and change the necessary BIOS settings, if any. See Chapter 2 for information on BIOS setup.
2. Assign an IRQ to the card.
3. Install the software drivers for the expansion card.



---

When using PCI cards on shared slots, ensure that the drivers support "Share IRQ" or that the cards do not need IRQ assignments. Otherwise, conflicts will arise between the two PCI groups, making the system unstable and the card inoperable.

---

### 1.5.3 PCI slots

The PCI slot supports cards such as a LAN card, SCSI card, USB card, and other cards that comply with PCI specifications.

### 1.5.4 PCI Express 2.0 x1 slots

This motherboard supports PCI Express x1 network cards, SCSI cards, and other cards that comply with the PCI Express specifications.

### 1.5.5 PCI Express 2.0 x16 slot

This motherboard has a PCI Express 2.0 x16 slot that supports PCI Express 2.0 x16 graphic cards complying with the PCI Express specifications.

## Recommended PCIe expansion cards configuration:

	PCIe Auto mode			M.2 PCIe mode enabled
PCIEX1_1	N/A	x1	x1	N/A
PCIEX1_2	N/A	N/A	x1	N/A
PXIEX16_3	x4	x2	x2	x2
M.2 socket	N/A	N/A	N/A	x2



M.2 Socket 3 shares bandwidth with PCIEx1\_1 & PCIEx1\_2 (in PCIe mode) and SATA6G\_4 (in SATA mode), and supports M Key and type 2260/2280 storage devices. Refer to section 2.6.3 PCH Storage Configuration and 2.6.7 Onboard Device Configuration of this user guide for more details.

## 1.5.6 PCI Express 3.0/2.0 x16 slots

This motherboard has two PCI Express 3.0/2.0 x16 slots that support PCI Express 3.0/2.0 x16 graphic cards complying with the PCI Express specifications.

VGA configuration	PCI Express operating mode		
	PCIe 3.0/2.0 x16_1 (gray)	PCIe 3.0/2.0 x16_2	PCIe 2.0 x16_3
Single VGA/PCIe card	x16 (Recommended for single VGA card)	N/A	N/A
Dual VGA/PCIe card	x8	x8	N/A



- In single VGA card mode, use the PCIe 3.0/2.0 x16\_1 slot (gray) for a PCI Express x16 graphics card to get better performance.
- We recommend that you provide sufficient power when running SLI™ or CrossFireX™ mode. See page 1-26 for details.
- Connect a chassis fan to the motherboard connector labeled CHA\_FAN1/2/3 when using multiple graphics cards for better thermal environment.

## IRQ assignments for this motherboard

	A	B	C	D	E	F	G	H
I.G.D.	Shared	-	-	-	-	-	-	-
HD Audio 1 Controller	-	-	-	-	-	-	Shared	-
EHCI 1 Controller	-	-	-	-	-	-	-	Shared
EHCI 2 Controller	Shared	-	-	-	-	-	-	-
XHCI Controller	-	-	-	-	-	Shared	-	-
SATA Controller	-	-	-	Shared	-	-	-	-
PCIE x16_1	Shared	-	-	-	-	-	-	-
PCIE x16_2	Shared	-	-	-	-	-	-	-
PCIE x16_3	Shared	-	-	-	-	-	-	-
PCIE x1_1	-	-	Shared	-	-	-	-	-
PCIE x1_2	-	-	-	Shared	-	-	-	-
Intel LAN	-	-	-	-	Shared	-	-	-
PCI Slot 1	-	-	-	Shared	-	-	-	-
PCI Slot 2	-	Shared	-	-	-	-	-	-

## 1.6 Jumpers

### Clear RTC RAM (3-pin CLRRTC)

This jumper allows you to clear the Real Time Clock (RTC) RAM in CMOS. You can clear the CMOS memory of date, time, and system setup parameters by erasing the CMOS RTC RAM data. The onboard button cell battery powers the RAM data in CMOS, which include system setup information such as system passwords.

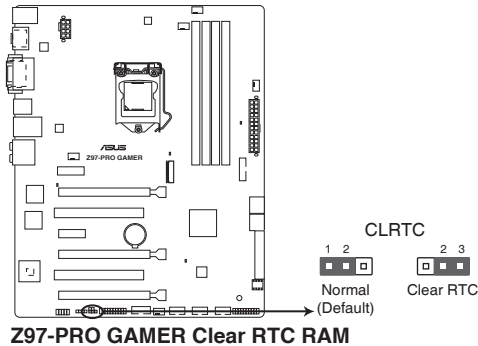

#### To erase the RTC RAM:

1. Turn OFF the computer and unplug the power cord.
2. Move the jumper cap from pins 1-2 (default) to pins 2-3. Keep the cap on pins 2-3 for about 5-10 seconds, then move the cap back to pins 1-2.
3. Plug the power cord and turn ON the computer.
4. Hold down the <Del> key during the boot process and enter BIOS setup to re-enter data.



---

Except when clearing the RTC RAM, never remove the cap on CLRRTC jumper default position. Removing the cap will cause system boot failure!

---



- If the steps above do not help, remove the onboard battery and move the jumper again to clear the CMOS RTC RAM data. After clearing the CMOS, reinstall the battery.
  - You do not need to clear the RTC when the system hangs due to overclocking. For system failure due to overclocking, use the CPU Parameter Recall (C.P.R.) feature. Shut down and reboot the system, then the BIOS automatically resets parameter settings to default values.
-

# 1.7 Connectors

## 1.7.1 Rear panel connectors

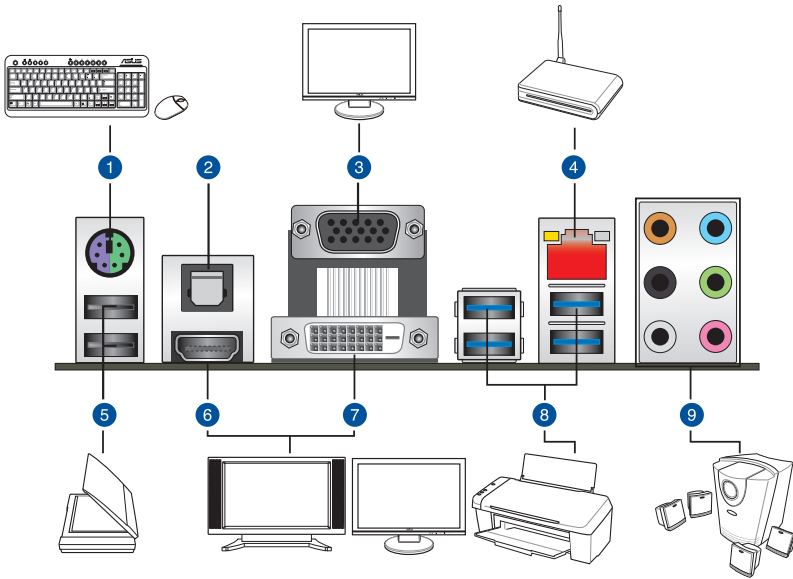

- PS/2 Mouse/Keyboard combo port.** This port connects to a PS/2 mouse or PS/2 keyboard.
- Optical S/PDIF out port.** This port allows you to connect your PC to amplified speakers, headphones, or Sony/Phillips Digital Interconnect Format (S/PDIF) compliant devices.
- Video Graphics Adapter (VGA) port.** This 15-pin port is for a VGA monitor or other VGA-compatible devices.
- LAN (RJ-45) port.** This port allows Gigabit connection to a Local Area Network (LAN) through a network hub.

### LAN port LED indications

Activity/Link LED		Speed LED	
Status	Description	Status	Description
Off	No link	OFF	10 Mbps connection
Orange	Linked	ORANGE	100 Mbps connection
Orange (Blinking)	Data activity	GREEN	1 Gbps connection
Orange (Blinking then steady)	Ready to wake up from S5 mode		

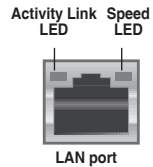



5. **USB 2.0 ports 7 and 8.** These two 4-pin Universal Serial Bus (USB) ports are for USB 2.0/1.1 devices.
6. **HDMI port.** This port connects to the tape, CD, DVD player, or other audio sources.
7. **DVI-D port.** This port is for any DVI-D compatible device.



DVI-D can not be converted to output from RGB Signal to CRT and is not compatible with DVI-I.

8. **USB 3.0 ports 3, 4, 5 and 6.** These 9-pin Universal Serial Bus (USB) ports are for USB 3.0 devices.



- The plugged USB 3.0 device may run on xHCI or EHCI mode, depending on the operating system's setting.
- USB 3.0 devices can only be used for data storage.
- We strongly recommend that you connect USB 3.0 devices to USB 3.0 ports for faster and better performance from your USB 3.0 devices.
- Due to the design of the Intel® 9 series chipset, all USB devices connected to the USB 2.0 and USB 3.0 ports are controlled by the xHCI controller. Some legacy USB devices must update their firmware for better compatibility.
- Multi-VGA output supports up to three displays under Windows® OS environment, two displays under BIOS, and one display under DOS.
- Intel display architecture design supports the following maximum supported pixel clocks (Pixel Clock = H total x V Total x Frame Rate (Screen refresh rate)):
  - DVI port: 165 MHz
  - VGA port: 180 MHz
  - HDMI port: 300 MHz

9. **8-channel audio ports.** Refer to the following table for the recommended audio configuration.

#### Audio 2, 4, 6, or 8-channel configuration

Port	Headset 2-channel	4-channel	6-channel	8-channel
Light Blue	Line In	Line In	Line In	Line In
Lime	Line Out	Front Speaker Out	Front Speaker Out	Front Speaker Out
Pink	Mic In	Mic In	Mic In	Mic In
Orange	–	–	Center/Subwoofer	Center/Subwoofer
Gray	–	–	–	Side Speaker Out
Black	–	Rear Speaker Out	Rear Speaker Out	Rear Speaker Out

## 1.7.2 Internal connectors

### 1. Serial port connector (10-1 pin COM)

This connector is for a serial (COM) port. Connect the serial port module cable to this connector, then install the module to a slot opening at the back of the system chassis.

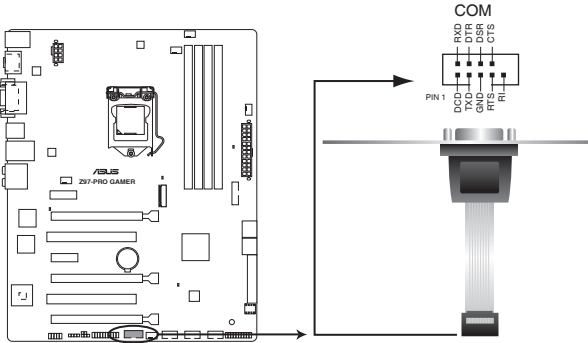

**Z97-PRO GAMER Serial port (COM) connector**



The COM module is purchased separately.

### 2. TPM connector (20-1 pin TPM)

This connector supports a Trusted Platform Module (TPM) system, which securely store keys, digital certificates, passwords and data. A TPM system also helps enhance the network security, protects digital identities, and ensures platform integrity.

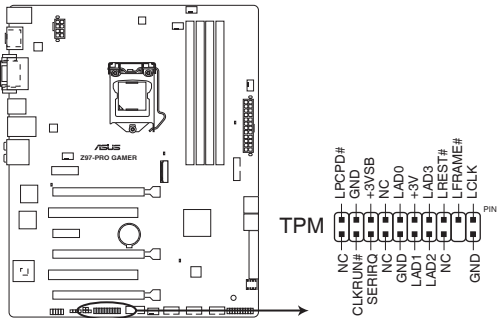

**Z97-PRO GAMER TPM connector**

### 3. CPU and chassis fan connectors (4-pin CPU\_FAN, 4-pin CPU\_OPT; 4-pin CHA\_FAN1, 4-pin CHA\_FAN2, 4-pin CHA\_FAN3)

Connect the fan cables to the fan connectors on the motherboard, ensuring that the black wire of each cable matches the ground pin of the connector.

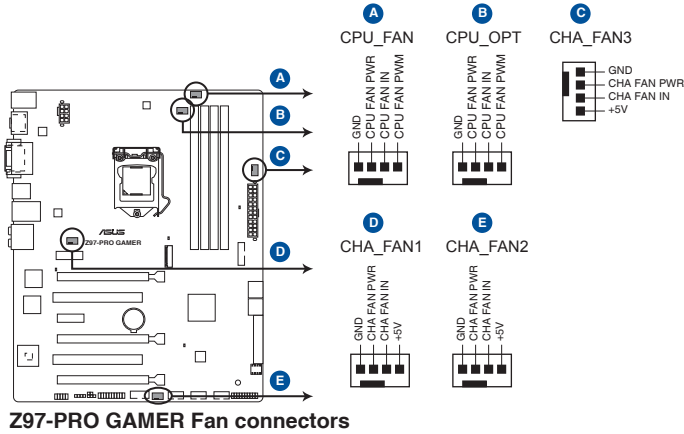

Do not forget to connect the fan cables to the fan connectors. Insufficient air flow inside the system may damage the motherboard components. These are not jumpers! Do not place jumper caps on the fan connectors! The CPU\_FAN connector supports a CPU fan of maximum 1 A (12 W) fan power.



- The CPU\_FAN connector and CHA\_FAN connectors support the ASUS FAN Xpert 3 feature.
- The CPU fan connector detects the type of CPU fan installed and automatically switches the control modes. To configure the CPU fan's control mode, go to **Advanced > Monitor > CPU Q-Fan Control** item in BIOS.
- The chassis fan connectors support DC and PWM modes. To set these fans to DC or PWM, go to **Advanced > Monitor > Chassis Fan 1/2/3 Q-Fan Control** items in BIOS.

#### 4. ATX power connectors (24-pin EATXPWR, 8-pin ATX12V)

These connectors are for ATX power supply plugs. The power supply plugs are designed to fit these connectors in only one orientation. Find the proper orientation and push down firmly until the connectors completely fit.

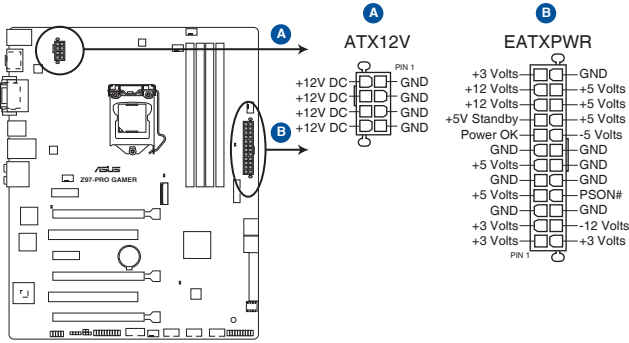

**Z97-PRO GAMER ATX power connectors**



- For a fully configured system, we recommend that you use a power supply unit (PSU) that complies with ATX 12 V Specification 2.0 (or later version) and provides a minimum power of 350 W.
- DO NOT forget to connect the 4-pin/8-pin ATX +12V power plug. Otherwise, the system will not boot up.
- We recommend that you use a PSU with higher power output when configuring a system with more power-consuming devices or when you intend to install additional devices. The system may become unstable or may not boot up if the power is inadequate.
- If you are uncertain about the minimum power supply requirement for your system, refer to the Recommended Power Supply Wattage Calculator at <http://support.asus.com/PowerSupplyCalculator/PSCalculator.aspx?SLanguage=en-us> for details.

## 5. Front panel audio connector (10-1 pin AAFP)

This connector is for a chassis-mounted front panel audio I/O module that supports either HD Audio or legacy AC'97 audio standard. Connect one end of the front panel audio I/O module cable to this connector.

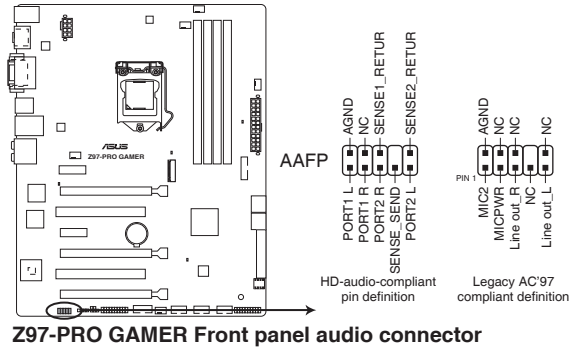

**Z97-PRO GAMER Front panel audio connector**



- We recommend that you connect a high-definition front panel audio module to this connector to avail of the motherboard's high-definition audio capability.
- If you want to connect a high-definition front panel audio module to this connector, set the Front Panel Type item in the BIOS setup to [HD]. If you want to connect an AC'97 front panel audio module to this connector, set the item to [AC97]. By default, this connector is set to [HD]. See section 2.6.7 Onboard Devices Configuration for details.

## 6. Digital audio connector (4-1 pin SPDIF\_OUT)

This connector is for an additional Sony/Philips Digital Interface (S/PDIF) port. Connect the S/PDIF Out module cable to this connector, then install the module to a slot opening at the back of the system chassis.

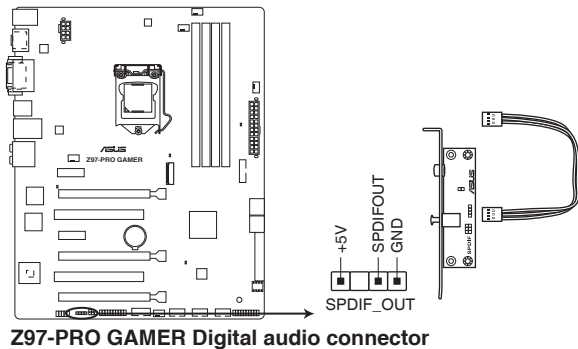

**Z97-PRO GAMER Digital audio connector**



The S/PDIF module is purchased separately.

**7. USB 3.0 connector (20-pin USB3\_12)**

This connector allows you to connect a USB 3.0 module for additional USB 3.0 front or rear panel ports. With an installed USB 3.0 module, you can enjoy all the benefits of USB 3.0 including faster data transfer speeds of up to 5 Gbps, faster charging time for USB-chargable devices, optimized power efficiency, and backward compatibility with USB 2.0.

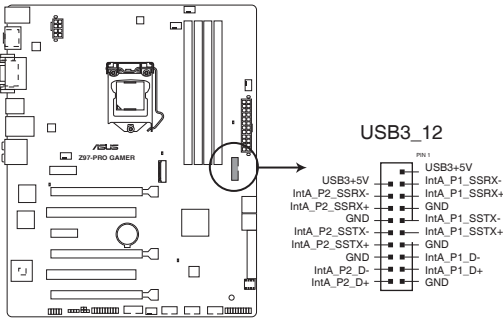

**Z97-PRO GAMER USB3.0 Front panel connector**



The USB 3.0 module is purchased separately.

**8. USB 2.0 connectors (10-1 pin USB910, USB1112, USB1314)**

These connectors are for USB 2.0 ports. Connect the USB module cable to any of these connectors, then install the module to a slot opening at the back of the system chassis. These USB connectors comply with USB 2.0 specifications and supports up to 480Mbps connection speed.

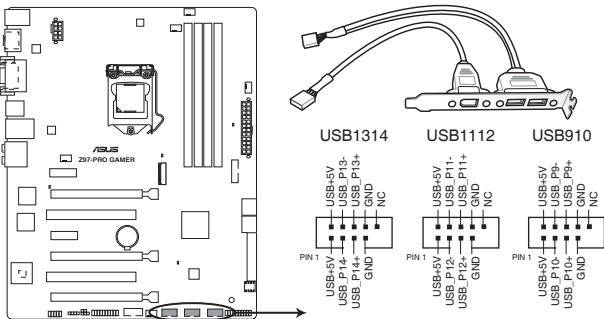

**Z97-PRO GAMER USB2.0 connectors**



Never connect a 1394 cable to the USB connectors. Doing so will damage the motherboard!



The USB 2.0 module is purchased separately.

## 9. Intel® Z97 Serial ATA 6.0Gb/s connector (7-pin SATA6G\_1~6, SATAEXPRESS)

This connector connects to Serial ATA 6.0 Gb/s hard disk drives via Serial ATA 6.0 Gb/s signal cables.

If you installed Serial ATA hard disk drives, you can create a RAID 0, 1, 5, and 10 configuration with the Intel® Rapid Storage Technology through the onboard Intel® Z97 chipset.

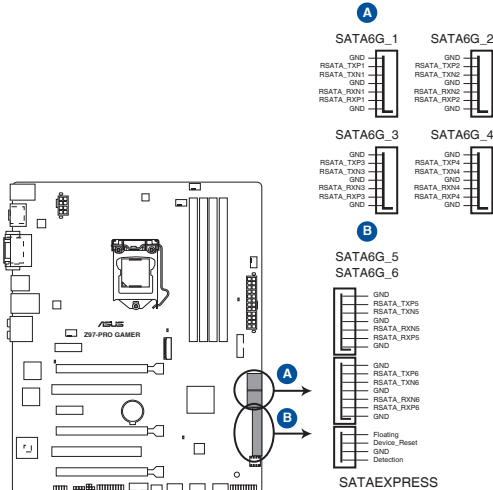

**Z97-PRO GAMER Intel® SATA 6.0Gb/s connectors**

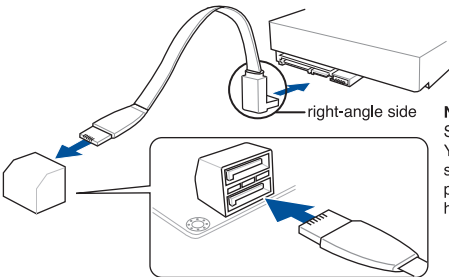

**NOTE:** Connect the right-angle side of SATA signal cable to SATA device. You may also connect the right-angle side of SATA cable to the onboard SATA port to avoid mechanical conflict with huge graphics cards.



- These connectors are set to **[AHCI]** by default. If you intend to create a Serial ATA RAID set using these connectors, set the SATA Mode item in the BIOS to **[RAID]**. Refer to section **2.6.3 PCH Storage Configuration** for details.
- Before creating a RAID set, refer to the manual bundled in the motherboard support DVD.



The SATAEXPRESS connector can support one SATA Express device or two SATA devices.

## 10. System panel connector (20-8 pin PANEL)

This connector supports several chassis-mounted functions.

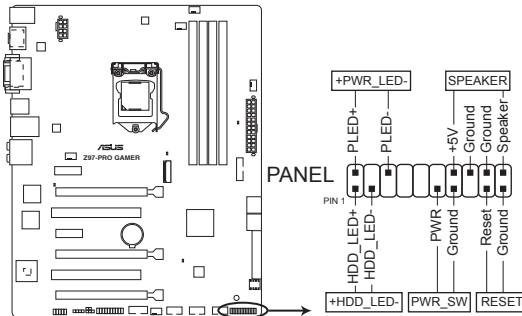

**Z97-PRO GAMER System panel connector**

- **System power LED (2-pin +PWR\_LED-)**

This 2-pin connector is for the system power LED. Connect the chassis power LED cable to this connector. The system power LED lights up when you turn on the system power, and blinks when the system is in sleep mode.

- **Hard disk drive activity LED (2-pin +HDD\_LED-)**

This 2-pin connector is for the HDD Activity LED. Connect the HDD Activity LED cable to this connector. The HDD LED lights up or flashes when data is read from or written to the HDD.

- **System warning speaker (4-pin SPEAKER)**

This 4-pin connector is for the chassis-mounted system warning speaker. The speaker allows you to hear system beeps and warnings.

- **ATX power button/soft-off button (2-pin PWR\_SW)**

This connector is for the system power button. Pressing the power button turns the system on or puts the system in sleep or soft-off mode depending on the operating system settings. Pressing the power switch for more than four seconds while the system is ON turns the system OFF.

- **Reset button (2-pin RESET)**

This 2-pin connector is for the chassis-mounted reset button for system reboot without turning off the system power.



## 11. M.2 socket 3

This socket allows you to install an M.2 (NGFF) SSD module.

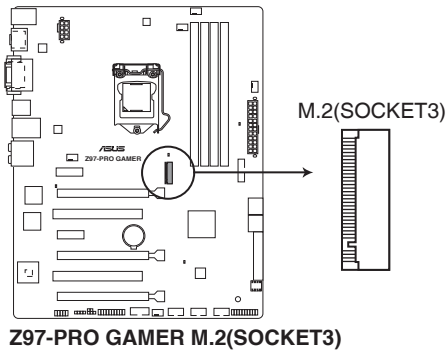

**Z97-PRO GAMER M.2(SOCKET3)**



- This socket supports M Key and 2260/2280 storage devices.
- M.2 Socket 3 shares bandwidth with PCIe<sub>x1\_1</sub> & PCIe<sub>x1\_2</sub> (in PCIe mode) and SATA6G\_4 (in SATA mode), and supports M Key and type 2260/2280 storage devices. Refer to section **2.6.3 PCH Storage Configuration** and **2.6.7 Onboard Device Configuration** of this user guide for more details.
- When using Intel® Desktop Responsiveness technologies with PCIe M.2 device, ensure to set up the Windows® UEFI operating system under RAID mode.



The M.2 (NGFF) SSD module is purchased separately

## 12. Thermal sensor connector (2-pin T\_SENSOR)

This connector is for the thermistor cable that allows you to monitor the temperature of your motherboard's critical components and connected devices.

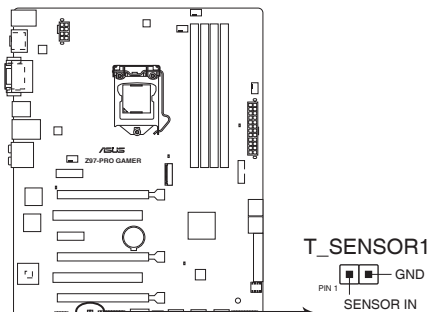

**Z97-PRO GAMER Thermal sensor connector**

## 1.8 Onboard LEDs

### 1. Standby Power LED (SB\_PWR)

The motherboard comes with a standby power LED that lights up to indicate that the system is ON, in sleep mode, or in soft-off mode. This is a reminder that you should shut down the system and unplug the power cable before removing or plugging in any motherboard component. The illustration below shows the location of the onboard LED.

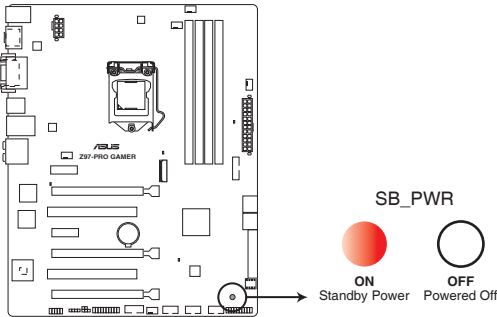

**Z97-PRO GAMER Onboard LED**

### 2. Q LEDs (BOOT\_DEVICE\_LED, VGA\_LED, DRAM\_LED, CPU\_LED)

Q LEDs check key components (CPU, DRAM, VGA card, and booting devices) in sequence during motherboard booting process. If an error is found, the corresponding LED flashes until the problem is solved. This user-friendly design provides an intuitive way to locate the root problem within seconds.

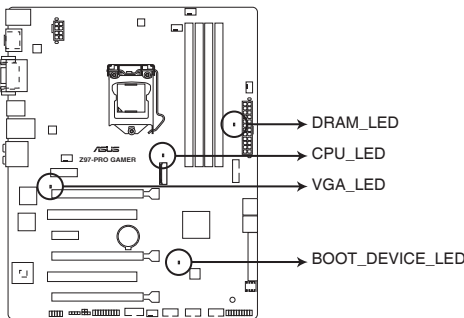

**Z97-PRO GAMER CPU/DRAM/  
BOOT\_DEVICE/VGA LED**

## 1.9 Software support

### 1.9.1 Installing an operating system

This motherboard supports Windows® 7 (32-bit / 64-bit), Windows® 8 (32-bit /64-bit) and Windows® 8.1 (32-bit /64-bit) Operating Systems (OS). Always install the latest OS version and corresponding updates to maximize the features of your hardware.



Motherboard settings and hardware options vary. Refer to your OS documentation for detailed information.

### 1.9.2 Support DVD information

The Support DVD that comes with the motherboard package contains the drivers, software applications, and utilities that you can install to avail all motherboard features.



The contents of the Support DVD are subject to change at any time without notice. Visit the ASUS website at [www.asus.com](http://www.asus.com) for updates.

#### To run the Support DVD

Place the Support DVD into the optical drive. If Autorun is enabled in your computer, the DVD automatically displays the lists of the unique features of your ASUS motherboard. Click the **Drivers**, **Utilities**, **AHCI/RAID Driver**, **Manual**, **Contact**, or **Specials** tabs to display their respective menus.



The following screen is for reference only.



Click an icon to display Support DVD/motherboard information

Click an item to install



If Autorun is NOT enabled in your computer, browse the contents of the Support DVD to locate the file ASSETUP.EXE from the BIN folder. Double-click the ASSETUP.EXE to run the DVD.



# BIOS information

# 2

## 2.1 Managing and updating your BIOS

The ASUS website publishes the latest BIOS versions to provide enhancements on system stability, compatibility, and performance. However, BIOS updating is potentially risky. If there is no problem using the current version of BIOS, DO NOT manually update the BIOS. Inappropriate BIOS updating may result to system's failure to boot. Carefully follow the instructions in this chapter to update your BIOS when necessary.



Visit <http://www.asus.com> to download the latest BIOS file for this motherboard.

The following utilities allow you to manage and update the motherboard BIOS setup program.

1. **EZ Update:** Updates the BIOS in Windows® environment.
2. **ASUS EZ Flash 2:** Updates the BIOS using a USB flash drive.
3. **ASUS CrashFree BIOS 3:** Restores the BIOS using the motherboard support DVD or a USB flash drive when the BIOS file fails or gets corrupted.
4. **ASUS BIOS Updater:** Updates the BIOS in DOS environment using the motherboard support DVD and a USB flash disk drive.



Save a copy of the original motherboard BIOS file to a USB flash disk in case you need to restore the BIOS in the future. Copy the original motherboard BIOS using the ASUS Update utility.

### 2.1.1 EZ Update

EZ Update is a utility that allows you to automatically update your motherboard's softwares, drivers, and the BIOS version easily. With this utility, you can also manually update the saved BIOS and select a boot logo when the system goes into POST.

Click to automatically update your motherboard's driver, software and firmware

Click to find and select the BIOS from file

Click to select a boot logo

Click to update the BIOS



EZ Update requires an Internet connection either through a network or an ISP (Internet Service Provider).

## 2.1.2 ASUS EZ Flash 2

The ASUS EZ Flash 2 feature allows you to update the BIOS without using an OS-based utility.



---

Before you start using this utility, download the latest BIOS file from the ASUS website at [www.asus.com](http://www.asus.com).

---

### To update the BIOS using EZ Flash 2:

1. Insert the USB flash disk that contains the latest BIOS file to the USB port.
2. Enter the **Advanced Mode** of the BIOS setup program. Go to the **Tool** menu to select **ASUS EZ Flash Utility** and press <Enter>.
3. Press the Right/Left arrow keys to switch to the **Drive** field.
4. Press the Up/Down arrow keys to find the USB flash disk that contains the latest BIOS then press <Enter>.
5. Press the Right/Left arrow keys to switch to the **Folder** field.
6. Press the Up/Down arrow keys to find the BIOS file then press <Enter> to perform the BIOS update process.
7. Reboot the system when the update process is done.



- This function supports USB flash disks formatted using FAT32 or FAT16 on a single partition only.
  - Ensure to load the BIOS default settings to ensure system compatibility and stability. Select the **Load Optimized Defaults** item under the **Exit** menu.
  - DO NOT shut down or reset the system while updating the BIOS to prevent system boot failure!
- 

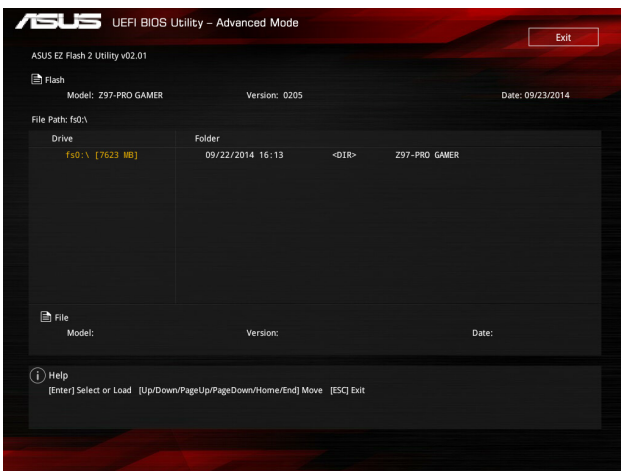

### 2.1.3 ASUS CrashFree BIOS 3 utility

The ASUS CrashFree BIOS 3 is an auto recovery tool that allows you to restore the BIOS file when it fails or gets corrupted during the updating process. You can restore a corrupted BIOS file using the motherboard support DVD or a USB flash drive that contains the updated BIOS file.



- Before using this utility, rename the BIOS file in the removable device into **Z97PROG.CAP**.
- Download the latest BIOS file from the ASUS website at [www.asus.com](http://www.asus.com).

#### Recovering the BIOS

##### To recover the BIOS:

1. Turn on the system.
2. Insert the support DVD into the optical drive or the USB flash drive that contains the BIOS file to the USB port.



The utility automatically checks the devices for the BIOS file. When found, the utility reads the BIOS file and automatically enters ASUS EZ Flash 2 utility. The system requires you to enter BIOS Setup to recover BIOS settings.



DO NOT shut down or reset the system while updating the BIOS! Doing so can cause system boot failure!

3. Press <F5> to load default BIOS values (Highly recommended).

### 2.1.4 ASUS BIOS Updater

ASUS BIOS Updater allows you to update the BIOS in DOS environment.



The screen captures used in this section are for reference only and may not be exactly the same as actually shown on your computer screen.

#### Before updating BIOS

- Prepare the motherboard support DVD and a USB flash drive.
- Download the latest BIOS file and BIOS Updater from <http://support.asus.com> and save them in your USB flash drive.



NTFS is not supported under FreeDOS environment. Ensure that your USB flash drive is in single partition and in FAT32 / FAT16 format.

- Turn off the computer.
- Ensure that your computer has a DVD optical drive.

## Booting the system in DOS environment

To boot the system in DOS:

1. Insert the USB flash drive with the latest BIOS file and BIOS Updater to the USB port.
2. Boot your computer then press <F8> to launch the BIOS Boot Device Select menu.
3. When the BIOS Boot Device Select Menu appears, insert the Support DVD into the optical drive then select the optical drive as the boot device.

```
Please select boot device:  
↑ and ↓ to move selection  
ENTER to select boot device  
ESC to boot using defaults  
-----  
P2: ST3808110AS (76319MB)  
aigo miniking (250MB)  
UEFI: (FAT) ASUS DRW-2014L1T(4458MB)  
P1: ASUS DRW-2014L1T(4458MB)  
UEFI: (FAT) aigo miniking (250MB)  
Enter Setup
```

4. When the Boot Loader appears, press <Enter> within five (5) seconds to enter FreeDOS prompt.

```
ISOLINUX 3.20 2006-08-26 Copyright (C) 1994-2005 H. Peter Anvin  
A Bootable DVD/CD is detected. Press ENTER to boot from the DVD/CD.  
If no key is pressed within 5 seconds, the system will boot next priority  
device automatically. boot:
```

5. On the FreeDOS prompt, type **d:** then press <Enter> to switch the disk from Drive C (optical drive) to Drive D (USB flash drive).

```
Welcome to FreeDOS (http://www.freedos.org)!  
C: /> d:  
D: />
```

## Updating the BIOS file

To update the BIOS file:

1. On the FreeDOS prompt, type **bupdater /pc /g** and press <Enter>.

```
D: /> bupdater /pc /g
```



- On the BIOS Updater screen, press <Tab> to switch from Files panel to Drives panel then select **D:**.

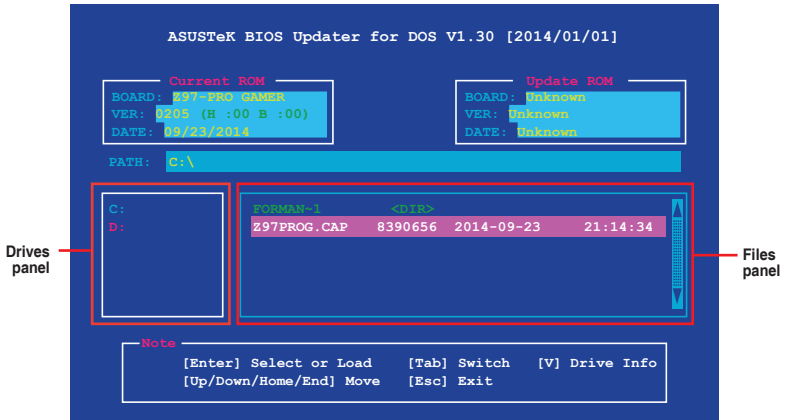

- Press <Tab> to switch from Drives panel to Files panel then press <Up/Down or Home/End> keys to select the BIOS file and press <Enter>.
- After the BIOS Updater checks the selected BIOS file, select **Yes** to confirm the BIOS update.



The BIOS Backup feature is not supported due to security regulations.

- Select **Yes** then press <Enter>. When BIOS update is done, press <ESC> to exit BIOS Updater.
- Restart your computer.



DO NOT shut down or reset the system while updating the BIOS to prevent system boot failure.



Ensure to load the BIOS default settings to ensure system compatibility and stability. Select the **Load Optimized Defaults** item under the **Exit** menu for more information.

## 2.2 BIOS setup program

Use the BIOS Setup program to update the BIOS or configure its parameters. The BIOS screens include navigation keys and brief online help to guide you in using the BIOS Setup program.

### Entering BIOS Setup at startup

To enter BIOS Setup at startup:

- Press <Delete> or <F2> during the Power-On Self Test (POST). If you do not press <Delete> or <F2>, POST continues with its routines.

### Entering BIOS Setup after POST

To enter BIOS Setup after POST:

- Press <Ctrl>+<Alt>+<Del> simultaneously.
- Press the reset button on the system chassis.
- Press the power button to turn the system off then back on. Do this option only if you failed to enter BIOS Setup using the first two options.



Using the power button, reset button, or the <Ctrl>+<Alt>+<Del> keys to force reset from a running operating system can cause damage to your data or system. We recommend you always shut down the system properly from the operating system.

---



- The BIOS setup screens shown in this section are for reference only. Some screen displays may not be the same as what you see on your screen.
  - Visit the ASUS website at [www.asus.com](http://www.asus.com) to download the latest BIOS file for this motherboard.
  - Ensure that a USB mouse is connected to your motherboard if you want to use the mouse to control the BIOS setup program.
  - If the system becomes unstable after changing any BIOS setting, load the default settings to ensure system compatibility and stability. Select the **Load Optimized Defaults** item under the Exit menu or press hotkey F5. See section **Exit Menu** for details.
  - If the system fails to boot after changing any BIOS setting, try to clear the CMOS and reset the motherboard to the default value. See section **Jumpers** for information on how to erase the RTC RAM.
- 

### BIOS menu screen

The BIOS setup program can be used under two modes: **EZ Mode** and **Advanced Mode**. Press <F7> to change between the two modes.

## EZ Mode

By default, the EZ Mode screen appears when you enter the BIOS setup program. The EZ Mode provides you an overview of the basic system information, and allows you to select the display language, system performance mode, and boot device priority. To access the Advanced Mode, press <F7>.



Refer to the item **Setup Mode** in section **Boot menu** for more details on how to change the default screen when entering the BIOS setup program.

The screenshot shows the ASUS UEFI BIOS Utility - EZ Mode interface. The interface is dark-themed and displays various system information and settings. The callouts point to the following features:

- Displays the CPU/motherboard temperature, CPU voltage output, CPU/chassis/power fan speed, and SATA information**: Points to the top-left information panel.
- Sets the system date and time**: Points to the top-center date and time display.
- Selects the display language of the BIOS setup program**: Points to the top-right language selection.
- Creates storage RAID and configures system overlocking**: Points to the EZ System Tuning section.
- Displays the system properties of the selected mode. Click < or > to switch EZ System Tuning modes**: Points to the EZ System Tuning section.
- Enables or disables the SATA RAID mode for Intel Rapid Storage Technology**: Points to the X.M.P. section.
- Displays the CPU Fan's speed. Click the button to manually tune the fans**: Points to the FAN Profile section.
- Selects the boot device priority**: Points to the Boot Priority section.
- Loads optimized default settings**: Points to the Default(F5) button.
- Saves the changes and resets the system**: Points to the Save & Exit(F10) button.
- Displays the Advanced mode menus**: Points to the Advanced Mode(F7) button.
- Selects the boot device priority**: Points to the Boot Menu(F8) button.



- The boot device options vary depending on the devices you installed to the system.
- The **Boot Menu(F8)** button is available only when the boot device is installed to the system.

## Advanced Mode

The Advanced Mode provides advanced options for experienced end-users to configure the BIOS settings. Refer to the following sections for the detailed configurations.



To access the EZ Mode, press <F7>.

The screenshot shows the ASUS UEFI BIOS Utility in Advanced Mode. The interface is dark-themed with red accents. At the top, there is a menu bar with options: My Favorites, Main, AI Tweaker, **Advanced**, Monitor, Boot, Tool, and Exit. Below the menu bar, there are several sections:

- Language:** A dropdown menu showing 'English'.
- MyFavorite:** A button labeled 'MyFavorite(F3)'.
- Q-Fan control:** A button labeled 'Qfan Control(F6)'.
- EZ Tuning Wizard:** A button labeled 'EZ Tuning Wizard(F11)'.
- Quick Note:** A button labeled 'Quick Note(F9)'.
- Hot Keys:** A button labeled 'Hot Keys'.
- Hardware Monitor:** A panel on the right side showing real-time system data:
  - CPU:** Frequency 2900 MHz, Temperature 74°C, BCLK 100.0 MHz, Vcore 0.935 V, Ratio 29x.
  - Memory:** Frequency 1333 MHz, Voltage 1.500 V, Capacity 4096 MB.
  - Voltage:** +12V +5V, 12.192 V 5.160 V, +3.3V 3.360 V.
- Configuration Fields:** A list of settings on the left side, each with a dropdown menu:
  - Intel Adaptive Thermal Monitor: Enabled
  - Hyper-threading: Enabled
  - Active Processor Cores: All
  - Limit CPUID Maximum: Disabled
  - Execute Disable Bit: Enabled
  - Intel Virtualization Technology: Disabled
  - Hardware Prefetcher(L2 Cache): Enabled
  - Adjacent Cache Line Prefetcher: Enabled
  - Boot performance mode: Max Non-Turbo Performance
  - Dynamic Storage Accelerator: Disabled
- Sub-menu item:** A section titled 'CPU Power Management Configuration' with a sub-item 'CPU Power Management Configuration'.
- General help:** A small information icon (i) next to the sub-menu item.
- Configuration fields:** A scroll bar on the right side of the configuration list.
- Last modified settings:** A button labeled 'Last Modified'.
- Goes back to EZ Mode:** A button labeled 'EZMode(F7)'.

At the bottom of the screen, there is a footer: 'Version 2.16.1240. Copyright (C) 2014 America Megatrends, Inc.'.

## Menu bar

The menu bar on top of the screen has the following main items:

<b>My Favorites</b>	For saving the frequently-used system settings and configuration
<b>Main</b>	For changing the basic system configuration
<b>Ai Tweaker</b>	For changing the overclocking settings
<b>Advanced</b>	For changing the advanced system settings
<b>Monitor</b>	For displaying the system temperature, power status, and changing the fan settings
<b>Boot</b>	For changing the system boot configuration
<b>Tool</b>	For configuring options for special functions
<b>Exit</b>	For selecting the exit options and loading default settings

## Menu items

The highlighted item on the menu bar displays the specific items for that menu. For example, selecting **Main** shows the Main menu items.

The other items (My Favorites, Ai Tweaker, Advanced, Monitor, Boot, Tool, and Exit) on the menu bar have their respective menu items.

## Submenu items

A greater than sign (>) before each item on any menu screen means that the item has a submenu. To display the submenu, select the item and press <Enter>.

## Language

This button above the menu bar contains the languages that you can select for your BIOS. Click this button to select the the language that you want to display in your BIOS screen.

## MyFavorites (F3)

This button above the menu bar shows all BIOS items in a Tree Map setup. Select frequently-used BIOS settings and save it to MyFavorites menu.



---

Refer to section **2.3 My Favorites** for more information.

---

## Q-Fan Control (F6)

This button above the menu bar displays the current settings of your fans. Use this button to manually tweak the fans to your desired settings.



---

Refer to section **2.2.3 QFan Control** for more information.

---

## EZ Tuning Wizard (F11)

This button above the menu bar allows you to view and tweak the overclocking settings of your system. It also allows you to change the motherboard's SATA mode from AHCI to RAID mode.



---

Refer to section **2.2.4 EZ Tuning Wizard** for more information.

---

### Quick Note (F9)

This button above the menu bar allows you to key in notes of the activities that you have done in BIOS.



- The Quick Note function does not support the following keyboard functions: delete, cut, copy and paste.
- You can only use the alphanumeric characters to enter your notes.

### Hot keys

This button above the menu bar contains the navigation keys for the BIOS setup program. Use the navigation keys to select items in the menu and change the settings.

### Scroll bar

A scroll bar appears on the right side of a menu screen when there are items that do not fit on the screen. Press the Up/Down arrow keys or <Page Up> / <Page Down> keys to display the other items on the screen.

### General help

At the bottom left of the menu screen is a brief description of the selected item. Use <F12> key to capture the BIOS screen and save it to the removable storage device.

### Configuration fields

These fields show the values for the menu items. If an item is user-configurable, you can change the value of the field opposite the item. You cannot select an item that is not user-configurable.

A configurable field is highlighted when selected. To change the value of a field, select it and press <Enter> to display a list of options.

### Last Modified button

This button shows the items that you last modified and saved in BIOS Setup.

## 2.2.3 QFan Control

The QFan Control allows you to set a fan profile or manually configure the operating speed of your CPU and chassis fans.

The screenshot shows the ASUS Q-Fan Tuning utility in the BIOS. The interface includes a title bar, a top menu, a main instruction area, a fan selection list, a graph, a profile slider, and control buttons. Red lines and boxes highlight specific features with text annotations.

**Click to select a fan to be configured** (points to the fan selection list)

**Click to activate PWM Mode** (points to the PWM/DC toggle)

**Click to activate DC Mode** (points to the PWM/DC toggle)

**Q-Fan Tuning**  
Select your target fan and then move the slider to select any of these profiles: Standard, Silent, Turbo and Full Speed). You can also move the slider to Manual and manually configure the fan's operating speed.

**CPU FAN**  
**CHA1 FAN**  
**CHA2 FAN**  
**CHA3 FAN**

**Standard** **Silent** **Turbo** **Full Speed** **Manual**

**Undo** **Apply** **Exit (ESC)**

**Select a profile to apply to your fans** (points to the profile slider)

**Click to undo the changes** (points to the Undo button)

**Click to apply the fan setting** (points to the Apply button)

**Click to go back to main menu** (points to the Exit (ESC) button)

ASUS UEFI BIOS Utility – Advanced Mode  
01/01/2009 Thursday 01:00  
English MyFavorite(F3) Qfan Control(F6) EZ Tuning Wizard(F11) Quick Note(F9) Hot Keys  
Version 2.16.1240. Copyright (C) 2014 American Megatrends, Inc.

## Configuring fans manually

Select **Manual** from the list of profiles to manually configure your fans' operating speed.

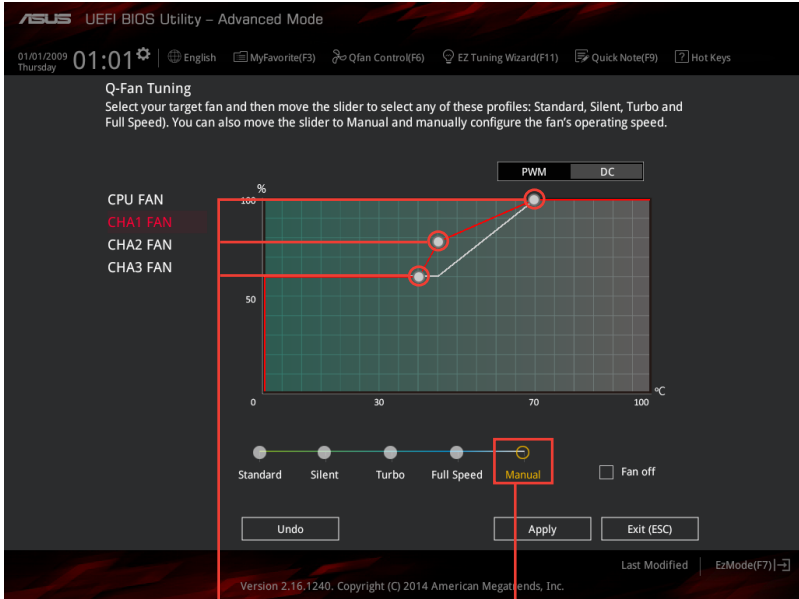

Speed points

Click to manually configure your fans

To configure your fans:

1. Select the fan that you want to configure and to view its current status.
2. Click and drag the speed points to adjust the fans' operating speed.
3. Click **Apply** to save the changes then click **Exit (ESC)**.



## 2.2.4 EZ Tuning Wizard

EZ Tuning Wizard allows you to overclock your CPU and DRAM, computer usage, and CPU fan to their best settings. You can also easily set RAID in your system using this feature.

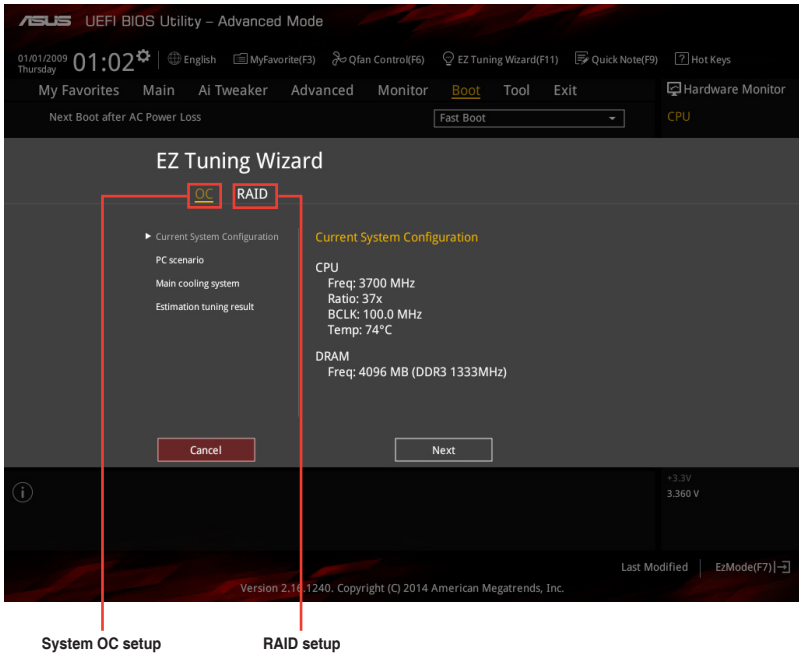

### Tuning your system settings

To tune your settings:

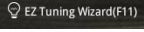
1. Press <F11> on your keyboard or click  from the BIOS screen to open EZ Tuning Wizard screen, then click **Next**.
2. Select a PC scenario **Daily Computing** or **Gaming/Media Editing**, then click **Next**.
3. Select the CPU fan type (**Box cooler**, **Tower cooler**, or **Water cooler**) that you installed then click **Next**.



If you are not sure of the CPU fan type, click **I'm not sure**. The system automatically detects the CPU fan type.

4. Click **Next** then click **Yes** to confirm auto-tuning.

## Creating RAID

To create RAID:

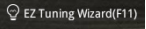
1. Press <F11> on your keyboard or click  from the BIOS screen to open EZ Tuning Wizard screen.
2. Click **RAID** then click **Next**.



- Ensure that your HDDs have no existing RAID volumes.
- Ensure to connect your HDDs to Intel® SATA connectors.

3. Select the type of storage for your RAID **Easy Backup** or **Super Speed**, then click **Next**.

- a. For Easy Backup, click **Next** then select from **Easy Backup (RAID1)** or **Easy Backup (RAID10)**.



You can only select Easy Backup (RAID 10) if you connect four (4) HDDs.

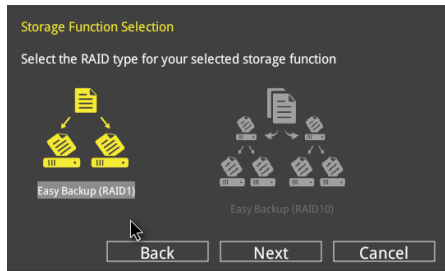

- b. For Easy Backup, click **Next** then select from **Super Speed (RAID0)** or **Super Speed (RAID5)**.

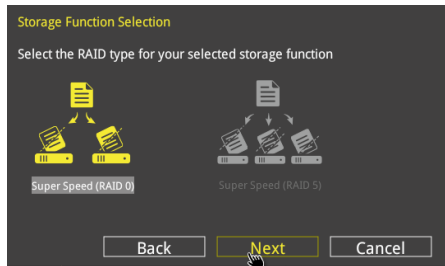

4. After selecting the type of RAID, click **Next** then click **Yes** to continue the RAID setup.
5. After the RAID setup is done, click **Yes** to exit the setup then click **OK** to reset your system.

## 2.3 My Favorites

MyFavorites is your personal space where you can easily save and access your favorite BIOS items.

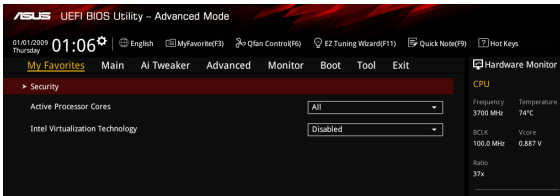

### Adding items to My Favorites

To add BIOS items:

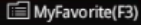
1. Press <F3> on your keyboard or click  from the BIOS screen to open Setup Tree Map screen.
2. On the Setup Tree Map screen, select the BIOS items that you want to save in MyFavorites screen.

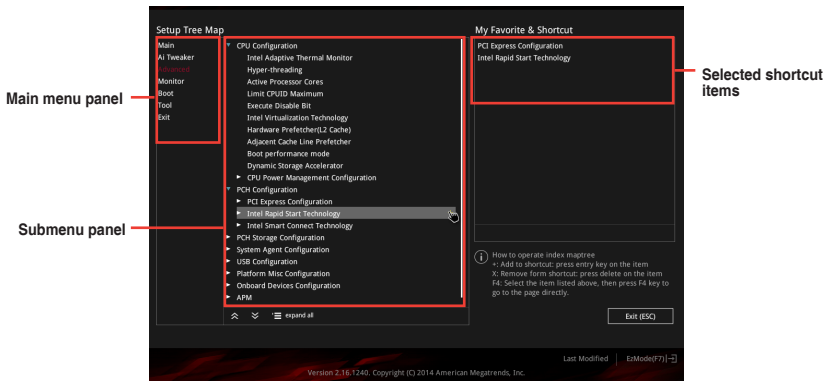

3. Select an item from main menu panel, then click the submenu that you want to save as favorite from the submenu panel and tap or click  or press <Enter> on your keyboard.



You cannot add the following items to My Favorite items:

- Items with submenu options
- User-managed items such as language and boot order
- Configuration items such as Memory SPD Information, system time and date.

4. Click **Exit (ESC)** or press <esc> key to close Setup Tree Map screen.
5. Go to My Favorites menu to view the saved BIOS items.

## 2.4 Main menu

The Main menu screen appears when you enter the Advanced Mode of the BIOS Setup program. The Main menu provides an overview of the basic system information and allows you to set the system date, time, language, and security settings.



### 2.4.1 System Language [English]

Allows you to choose the BIOS language version from the options. Configuration options: [English] [Français] [Deutsch] [简体中文] [繁體中文] [日本語] [Español] [Русский] [한국어]

### 2.4.2 Security

The Security menu items allow you to change the system security settings.



- If you have forgotten your BIOS password, erase the CMOS Real Time Clock (RTC) RAM to clear the BIOS password. See section **Jumpers** for information on how to erase the RTC RAM.
- The **Administrator** or **User Password** items on top of the screen show the default **Not Installed**. After you set a password, these items show **Installed**.

### Administrator Password

If you have set an administrator password, we recommend that you enter the administrator password for accessing the system. Otherwise, you might be able to see or change only selected fields in the BIOS setup program.

#### To set an administrator password:

1. Select the **Administrator Password** item and press <Enter>.
2. From the **Create New Password** box, key in a password, then press <Enter>.
3. Confirm the password when prompted.

### **To change an administrator password:**

1. Select the **Administrator Password** item and press <Enter>.
2. From the **Enter Current Password** box, key in the current password, then press <Enter>.
3. From the **Create New Password** box, key in a new password, then press <Enter>.
4. Confirm the password when prompted.

To clear the administrator password, follow the same steps as in changing an administrator password, but press <Enter> when prompted to create/confirm the password. After you clear the password, the **Administrator Password** item on top of the screen shows **Not Installed**.

### **User Password**

If you have set a user password, you must enter the user password for accessing the system. The **User Password** item on top of the screen shows the default **Not Installed**. After you set a password, this item shows **Installed**.

#### **To set a user password:**

1. Select the **User Password** item and press <Enter>.
2. From the **Create New Password** box, key in a password, then press <Enter>.
3. Confirm the password when prompted.

#### **To change a user password:**

1. Select the **User Password** item and press <Enter>.
2. From the **Enter Current Password** box, key in the current password, then press <Enter>.
3. From the **Create New Password** box, key in a new password, then press <Enter>.
4. Confirm the password when prompted.

To clear the user password, follow the same steps as in changing a user password, but press <Enter> when prompted to create/confirm the password. After you clear the password, the **User Password** item on top of the screen shows **Not Installed**.

## 2.5 Ai Tweaker menu

The Ai Tweaker menu items allow you to configure overclocking-related items.



Be cautious when changing the settings of the Ai Tweaker menu items. Incorrect field values can cause the system to malfunction.



The configuration options for this section vary depending on the CPU and DIMM model you installed on the motherboard.

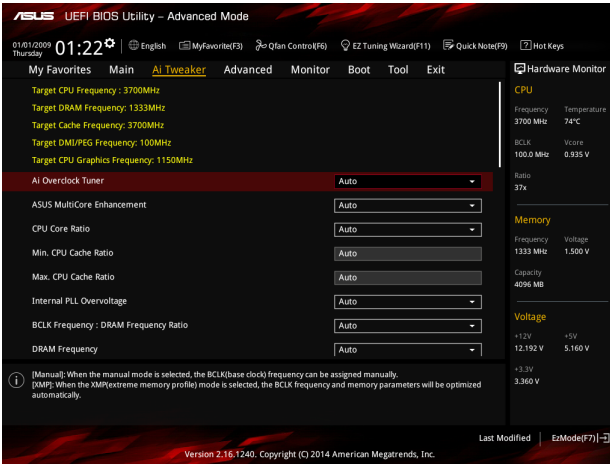

Scroll down to display the following items:

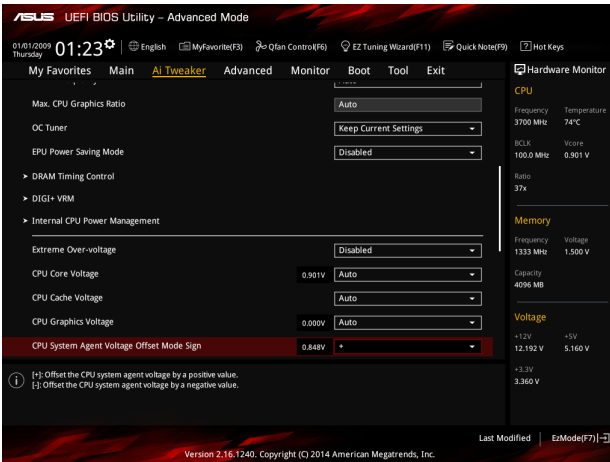

Scroll down to display the following items:

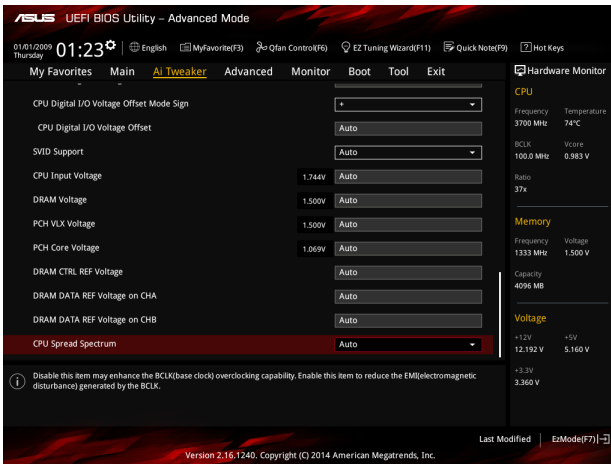

### Target CPU Frequency: xxxxMHz

Displays the target CPU frequency.

### Target DRAM Frequency: xxxxMHz

Displays the target DRAM frequency.

### Target Cache Frequency: xxxxMHz

Displays the target Cache frequency.

### Target DMI/PEG Frequency: xxxxMHz

Displays the target DMI/PEG frequency.

### Target CPU Graphics Frequency: xxxxMHz

Displays the target CPU Graphics frequency.

## 2.5.1 Ai Overclock Tuner [Auto]

This item allows you to select the CPU overclocking options to achieve the desired CPU internal frequency. Select any of these preset overclocking configuration options:

- [Auto] Loads the optimal settings for the system.
- [Manual] Automatically optimizes the CPU ratio and BCLK frequency.
- [XMP] Allows your system to automatically optimize the CPU ratio, BCLK frequency, and memory parameters. If you install memory modules supporting the eXtreme Memory Profile (X.M.P.) Technology, select this item to set the profiles supported by your memory modules for optimizing the system performance.



The following items appear only when you set the Ai Overclocking Tuner to **[Manual]**.

## CPU Strap [Auto]

This item allows you to select a strap close to your target BCLK (base clock) for an extreme overclocking, or leave it at **[Auto]** for the BIOS to upgrade. Configuration options: [Auto] [100MHz] [125MHz] [166MHz] [250MHz]



---

The following item appears only when you set the CPU Strap to **[100MHz]**, **[125MHz]**, **[167MHz]**, or **[250MHz]**.

---

## Source Clock Tuner [Auto]

This item allows you to select the source clock based on the assigned CPU strap for a better overclocking capability. Configuration options: [8Ohm db] [7Ohm db] [6Ohm db] [5Ohm db] [4Ohm db] [3Ohm db] [2Ohm db]

## PLL Selection [Auto]

This item is set to LC PLL by default for better stability. Select SB PLL when the BCLK (base clock) frequency is far away from 100 MHz. This may affect the function of other devices that need precise clock jitters. Configuration options: [Auto] [LC PLL] [SB PLL]

## Filter PLL [Auto]

Set this item to high BCLK (base clock) mode when using a very high BCLK to improve overclocking capability. Configuration options: [Auto] [Low BCLK mode] [High BCLK mode]

## BCLK Frequency [Auto]

This item allows you to set the BCLK (base clock) frequency to enhance the system performance. Use the <+> or <-> to adjust the value. The values range from 80.0 MHz to 300.0 MHz.



---

We recommend you to set the value based on the CPU specification, as high BCLK frequencies may damage the CPU permanently.

---

## Initial BCLK Frequency [Auto]

This item allows you to start overclocking the system from the initial BCLK (base clock) frequency to the assigned BCLK frequency. Use the <+> or <-> to adjust the value. The value ranges depend on the value you set on BCLK Frequency.

## 2.5.2 ASUS MultiCore Enhancement [Auto]

[Auto] This item allows you to maximize the overlocking performance optimized by ASUS core ratio settings.

[Disabled] This item allows you to set to default core ratio settings.

## 2.5.3 CPU Core Ratio [Auto]

Allows you to set the CPU core ratio automatically or manually.

[Auto] Sets all CPU Core Ratio to Intel® CPU default settings automatically.

[Sync All Cores] Allows you to set CPU Core Ratio settings for all cores.

[Per Core] Allows you to set CPU Core Ratio individually.





---

The following two items appear only when you set the **CPU Core Ratio** to **[Sync All Cores]** or **[Per Core]**.

---

### **1-Core Ratio Limit [Auto]**

Select **[Auto]** to apply the CPU default Turbo Ratio setting or manually assign a 1-Core Limit value that must be higher than or equal to the 2-Core Ratio Limit.

### **2-Core Ratio Limit [Auto]**

Select **[Auto]** to apply the CPU default Turbo Ratio setting or manually assign a 2-Core Limit value that must be higher than or equal to the 3-Core Ratio Limit.



---

If you assign a value for 2-Core Ratio Limit, do not set the 1-Core Ratio Limit to **[Auto]**.

---

### **3-Core Ratio Limit [Auto]**

Select **[Auto]** to apply the CPU default Turbo Ratio setting or manually assign a 3-Core Limit value that must be higher than or equal to the 4-Core Ratio Limit.



---

If you assign a value for 3-Core Ratio Limit, do not set the 1-Core Ratio Limit and 2-Core Ratio Limit to **[Auto]**.

---

### **4-Core Ratio Limit [Auto]**

Select **[Auto]** to apply the CPU default Turbo Ratio setting or manually assign a 4-Core Limit value that must be higher than or equal to the 3-Core Ratio Limit.



---

If you assign a value for 4-Core Ratio Limit, do not set the 1-Core Ratio Limit, 2-Core Ratio Limit, and 3-Core Ratio to **[Auto]**.

---

## **2.5.4 Min. CPU Cache Ratio [Auto]**

This item allows you to set the minimum possible ratio on the Uncore part of the processor. Use the <+> or <-> keys to adjust the value. The values depend on the CPU installed.

## **2.5.5 Max. CPU Cache Ratio [Auto]**

This item allows you to set the maximum possible ratio on the Uncore part of the processor. Use the <+> or <-> keys to adjust the value. The values depend on the CPU installed.

## **2.5.6 Internal PLL Overvoltage [Auto]**

Allows you to enable the internal PLL Overvoltage for K-SKU CPUs to get the extreme overclocking capability. Configuration options: **[Auto]** **[Enabled]** **[Disabled]**

## **2.5.7 BCLK Frequency: DRAM Frequency Ratio [Auto]**

Allows you to set the CPU bus speed to DRAM speed ratio mode.

- [Auto]** DRAM speed is set to the optimized settings.
- [100:133]** The BCLK frequency to DRAM speed ratio is set to 100:133.
- [100:100]** The BCLK frequency to DRAM speed ratio is set to 100:100.

## 2.5.8 DRAM Frequency [Auto]

This item allows you to set the memory operating frequency. The configurable options vary with the BCLK (base clock) frequency setting. Select the auto mode to apply the optimized setting. Configuration options: [DDR3-800MHz] [DDR3-1066MHz] [DDR3-1333MHz] [DDR3-1400MHz] [DDR3-1600MHz] [DDR3-1800MHz] [DDR3-1866MHz] [DDR3-2000MHz] [DDR3-2133MHz] [DDR3-2200MHz] [DDR3-2400MHz] [DDR3-2600MHz] [DDR3-2666MHz] [DDR3-2800MHz] [DDR3-2933MHz] [DDR3-3000MHz] [DDR3-3200MHz] [DDR3-3400MHz]



Selecting a very high memory frequency may cause the system to become unstable! If this happens, revert to the default setting.

## 2.5.9 Max. CPU Graphics Ratio [Auto]

Allows you to set the CPU Graphics ratio. Use <+>/<-> to adjust the value. The ratio may vary depending on the system loading.

## 2.5.10 OC Tuner [Keep Current Settings]

This item allows you to automatically overclock the CPU and DRAM frequencies and voltage for an enhanced system performance. It also accelerates the CPU graphics performance to the extreme depending on the CPU graphics loading. Configuration options: [Keep Current Settings] [Ratio Tuning] [BCLK + Ratio Tuning]



Ensure that you installed an efficient CPU fan for CPU and graphics loading before selecting either [BCLK + Ratio Tuning] or [Ratio Tuning]. To keep the current overclocking tuner status, select [Keep Current Settings].

## 2.5.11 EPU Power Saving Mode [Disabled]

ASUS EPU (Energy Processing Unit) sets the CPU in its minimum power consumption settings. Enable this item to set lower CPU VCCIN and Vcore voltages and achieve the best energy saving condition. Configuration options: [Disabled] [Enabled]

## 2.5.12 DRAM Timing Control

The subitems in this menu allow you to set the DRAM timing control features. Use the <+> and <-> keys to adjust the value. To restore the default setting, type [auto] using the keyboard and press the <Enter> key.



Changing the values in this menu may cause the system to become unstable! If this happens, revert to the default settings.

## 2.5.13 DIGI+ VRM

### CPU Load-Line Calibration [Auto]

Load-line is defined by Intel VRM specification and affects the CPU power voltage. The CPU working voltage will decrease proportionally depending on the CPU loading. Higher levels of the load-line calibration can get a higher voltage and a better overclocking performance but increases the CPU and VRM thermal. Configuration options: [Auto] [Level 1] [Level 2] [Level 3] [Level 4] [Level 5] [Level 6] [Level 7] [Level 8] [Level 9]



The boosted performance may vary depending on the CPU specification. Do not remove the thermal module.

## CPU VRM Switching Frequency [Auto]

This item affects the VRM transient response speed and the component thermal production. Select [Manual] to configure a higher frequency for a quicker transient response speed. Configuration options: [Auto] [Manual]



---

DO NOT remove the thermal module. The thermal conditions should be monitored.

---



---

The following item appears only when you set the CPU VRM Switching Frequency to [Manual].

---

### Fixed CPU VRM Switching Frequency (KHz) [300]

This item allows you to set a higher frequency for a quicker transient response speed. Use the <+> and <-> keys to adjust the value. The values range from 300KHz to 500KHz with a 50KHz interval.

## CPU Power Phase Control [Auto]

This item allows you to set the power phase control of the CPU. Configuration options: [Auto] [Standard] [Optimized] [Extreme]

### CPU Power Duty Control [T.Probe]

DIGI + VRM Duty control adjusts the current and thermal conditions of every component's phase.

[T. Probe] Select to maintain the VRM thermal balance.

[Extreme] Select to maintain the current VRM balance.

### CPU Current Capability [Auto]

Allows you to configure the total power range, and extends the overclocking frequency range simultaneously. Configuration options: [Auto] [100%] [110%] [120%] [130%] [140%]



---

Choose a higher value when overclocking, or under a high CPU loading for extra power support.

---

## 2.5.14 Internal CPU Power Management

The subitems in this menu allow you to set the CPU ratio and their features.

### Enhanced Intel SpeedStep Technology [Enabled]

This item allows the operating system to dynamically adjust the processor voltage and cores frequency, resulting to a decreased average power consumption and decreased average heat production. Configuration options: [Disabled] [Enabled]

### Turbo Mode Parameters

#### Long Duration Package Power Limit [Auto]

Allows you to limit the Turbo Ratio's time duration that exceeds the TDP (Thermal Design Power) for maximum performance. Use the <+> or <-> keys to adjust the value. The values range from 1 W to 4096 W.

### **Package Power Time Window [Auto]**

Also known as Power Limit 1, this item allows you to maintain the time window for Turbo Ratio over TDP (Thermal Design Power). Use the <+> or <-> keys to adjust the value. The values range from 1 to 127 in seconds.

### **Short Duration Package Power Limit [Auto]**

Also known as Power Limit 2, this item allows you to provide rapid protection when the package power exceeds the Power Limit 1. Use the <+> or <-> keys to adjust the value. The values range from 1 W to 4096 W.

### **CPU Integrated VR Current Limit [Auto]**

Allows you to set a higher current limit to prevent frequency and power throttling when overlocking. Use the <+> or <-> keys to adjust the value. The values range from 0.125 to 1023.875 with a 0.125 interval.

## **CPU Internal Power Switching Frequency**

### **Frequency Tuning Mode [Auto]**

This item allows you to increase or decrease the switching frequency of the internal regulator. Decrease the switching frequency to reduce the power consumption or increase the switching frequency to enhance voltage stability. When this item is set to [+] or [-], the Frequency Tuning Offset appears that allows you to set its value from 0% to 6%.

## **CPU Internal Power Fault Control**

### **Thermal Feedback [Auto]**

Allows your system to take precautionary actions to protect the CPU when the thermal condition of the external regulator exceeds the threshold. Configuration options: [Auto] [Disabled] [Enabled]

### **CPU Integrated VR Fault Management [Auto]**

Disable this item to prevent tripping the Fully Integrated Voltage Regulator when doing over-voltage. We recommend you to disable this item when overlocking. Configuration options: [Auto] [Disabled] [Enabled]

## **CPU Internal Power Configuration**

### **CPU Integrated VR Efficiency Management [Auto]**

This item allows you to improve the power rating when the CPU is in low power state, or make the FIVR (fully integrated voltage regulator work in high performance at all times. Configuration options: [Auto] [High Performance] [Balanced]

### **Power Decay Mode [Auto]**

This item allows your system to improve the power saving mode on the Fully Integrated Voltage Regulator as the processor goes into low current state. Configuration options: [Auto] [Disabled] [Enabled]

### **Idle Power-in Response [Auto]**

This item allows you to set the slew rate for the Fully Integrated Voltage Regulator when it enters manual override mode. Configuration options: [Auto] [Regular] [Fast]

### **Idle Power-out Response [Auto]**

This item allows you to set the slew rate for the Fully Integrated Voltage Regulator when it exits manual override mode. Configuration options: [Auto] [Regular] [Fast]

### **Power Current Slope [Auto]**

This item allows you to enhance the power saving condition or the system overlocking capability. Select a higher power current slope levels for power saving enhancement or lower power current slope levels for system overlocking enhancement.

Configuration options: [Auto] [LEVEL -4] [LEVEL -3] [LEVEL -2] [LEVEL -1] [LEVEL 0] [LEVEL 1] [LEVEL 2] [LEVEL 3] [LEVEL 4]

### **Power Current Offset [Auto]**

This item allows you to increase or decrease the output current sensed by the CPU. It finds the balance between optimal regulating while staying below the current threshold.

Configuration options: [Auto] [100%] [87.5%] [75.0%] [62.5%] [50.0%] [37.5%] [25.0%] [12.5%] [0%] [-12.5%] [-25.0%] [-37.5%] [-50.0%] [-62.5%] [-75.0%] [-87.5%] [-100%]

### **Power Fast Ramp Response [Auto]**

This item allows you to enhance the response of the CPU voltage regulator during the load transients. Use the <+> or <-> to adjust the value. The values range from 0.00 to 1.50. Configuration options: [Auto] [0.00] - [1.50]

## **CPU Internal Power Saving Control**

### **Power Saving Level 1 Threshold [Auto]**

Lower value provides sufficient overlocking tolerance to enlarge the overlocking potential. Higher value provides better power-saving condition. Use <+> or <-> key to adjust the value. The values range from 0 A to 80 A at 1 A increment.

### **Power Saving Level 2 Threshold [Auto]**

Lower value provides sufficient overlocking tolerance to enlarge the overlocking potential. Higher value provides better power-saving condition. Use <+> or <-> key to adjust the value. The values range from 0 A to 50 A at 1 A increment.

### **Power Saving Level 3 Threshold [Auto]**

Lower value provides sufficient overlocking tolerance to enlarge the overlocking potential. Higher value provides better power-saving condition. Use <+> or <-> key to adjust the value. The values range from 0 A to 30 A at 1A increment.

## **2.5.15 Extreme Over-voltage [Disabled]**

This item allows you to set higher voltages for overlocking. When you enable this item, you can choose a high level voltage to overclock, but does not guarantee the CPU life. Configuration options: [Disabled] [Enabled]

## **2.5.16 CPU Core Voltage [Auto]**

This item allows you to configure the amount of voltage fed to the CPU cores. Increase the voltage when setting a high Core Frequency value. Configuration options: [Auto] [Manual Mode] [Offset Mode] [Adaptive Mode]



- 
- The following item appears only when you set the CPU Core Voltage to **[Manual Mode]**.
  - **[Adaptive Mode]** is available for some specific CPU types.
- 

## CPU Core Voltage Override [Auto]

Allows you to set the CPU Core Voltage override. Use the <+> or <-> keys to adjust the value. The values range from 0.001V to 1.920V with a 0.001V interval.



---

The following items appear only when you set the CPU Core Voltage to **[Offset Mode]** or **[Adaptive Mode]**.

---

### Offset Mode Sign [+]

- [+] To offset the voltage by a positive value.
- [-] To offset the voltage by a negative value.

### CPU Core Voltage Offset

Use the <+> or <-> keys to adjust the value. The values range from 0.001V to 0.999V with a 0.001V interval.



---

The following item appears only when you set the CPU Core Voltage to **[Adaptive Mode]**.

---

### Additional Turbo Mode CPU Core Voltage [Auto]

This item allows you to set the amount of voltage fed to the CPU cores when running in turbo mode. Increase the voltage when configuring a high CPU core frequency. The voltage you set is affected by the offset value. Use the <+> or <-> keys to adjust the value. The values range from 0.001V to 1.920 V with a 0.001 V interval.

### Total Adaptive Mode CPU Core Voltage [Auto]

This item sums up the voltages of the CPU Core Voltage offset and Additional Turbo Mode CPU Core Voltage options.

## 2.5.17 CPU Cache Voltage [Auto]

This item allows you to set the amount of voltage fed to the CPU uncores including its cache. Increase the voltage when setting a high CPU cache frequency. Configuration options: [Auto] [Manual Mode] [Offset Mode] [Adaptive Mode]



- 
- The following item appears only when you set the CPU Core Voltage to **[Manual Mode]**.
  - **[Adaptive Mode]** is available for some specific CPU types.
- 

### CPU Cache Voltage Override [Auto]

This item allows you to set the CPU Cache Voltage override. By default, this item takes the standard value of the installed CPU. You can use the <+> or <-> keys to adjust the value. The values range from 0.001V to 1.920V with a 0.001V interval.



---

The following items appear only when you set the CPU Cache Voltage to **[Offset Mode]** or **[Adaptive Mode]**.

---

### Offset Mode Sign **[+]**

- [+]** To offset the voltage by a positive value.
- [-]** To offset the voltage by a negative value.

### CPU Cache Voltage Offset

Allows you to set the CPU cache voltage offset. By default, this item takes the standard value of the installed CPU. You can use the <+> or <-> keys to adjust the value. The values range from 0.001V to 0.999V with a 0.001V interval.



---

The following items appear only when you set the CPU Cache Voltage to **[Adaptive Mode]**.

---

### Additional Turbo Mode CPU Cache Voltage **[Auto]**

This item allows you to set the amount of voltage fed to the CPU cores when running in turbo mode. Increase the voltage when configuring a high CPU core frequency. The voltage you set is affected by the offset value. Use the <+> or <-> keys to adjust the value. The values range from 0.001V to 1.920V with a 0.001V interval.

### Total Adaptive Mode CPU Cache Voltage **[Auto]**

This item sums up the voltages of the CPU Cache Voltage offset and Additional Turbo Mode CPU Cache Voltage options.

## 2.5.18 CPU Graphics Voltage **[Auto]**

This item allows you to set the CPU graphics voltage. Increase the graphics voltage when increasing the iGPU frequency. Configuration options: **[Auto]** **[Manual Mode]** **[Offset Mode]** **[Adaptive Mode]**.



- The following item appears only when you set the CPU Graphics Voltage to **[Manual Mode]**.
  - **[Adaptive Mode]** is available for some specific CPU types.
- 

### CPU Graphics Voltage Override **[Auto]**

This item allows you to set the CPU graphics voltage override. The values range from 0.001V to 1.920V with a 0.001V interval.



---

The following items appear only when you set the CPU Graphics Voltage to **[Offset Mode]** or **[Adaptive Mode]**.

---

### Offset Mode Sign **[+]**

- [+]** To offset the voltage by a positive value.
- [-]** To offset the voltage by a negative value.

### CPU Graphics Voltage Offset **[Auto]**

This item appears only when you set the CPU Graphics Voltage to **[Offset Mode]** or **[Adaptive Mode]** and allows you to set the CPU graphics voltage offset. The values range from 0.001V to 0.999V with a 0.001V interval.



---

The following items appear only when you set the CPU Graphics Voltage to [Adaptive Mode].

---

### **Additional Turbo Mode CPU Graphics Voltage [Auto]**

This item appears only when you set the CPU Graphics Voltage to [Adaptive Mode] and allows you to set the additional turbo mode CPU graphics voltage. The values range from 0.001V to 1.920V with a 0.001V interval.

### **Total Adaptive Mode CPU Graphics Voltage [By CPU]**

This item sums up the voltages of the CPU Graphics Voltage offset and Additional Turbo Mode CPU Graphics Voltage options.

## **2.5.19 CPU System Agent Voltage Offset Mode Sign [+]**

- [+] To offset the voltage by a positive value.
- [-] To offset the voltage by a negative value.

### **CPU System Agent Voltage Offset [Auto]**

This item allows you to set the amount of voltage fed to the system agent of the CPU including its PCIe controller and the PCU (power control unit). Increase the voltage to enhance the overclocking capability. You can use the <+> or <-> keys to adjust the value. The values range from 0.001V to 0.999V with a 0.001V interval.

## **2.5.20 CPU Analog I/O Voltage Offset Mode Sign [+]**

- [+] To offset the voltage by a positive value.
- [-] To offset the voltage by a negative value.

### **CPU Analog I/O Voltage Offset [Auto]**

This item allows you to set the amount of voltage fed to the analog portion of the I/O on the CPU. By default, this item takes the standard value of the installed CPU. Increase the amount of voltage to enhance the overclocking capability. You can use the <+> or <-> keys to adjust the value. The values range from 0.001V to 0.999V with a 0.001V interval.

## **2.5.21 CPU Digital I/O Voltage Offset Mode Sign [+]**

- [+] To offset the voltage by a positive value.
- [-] To offset the voltage by a negative value.

### **CPU Digital I/O Voltage Offset [Auto]**

This item allows you to set the amount of voltage fed to the digital portion of the I/O on the processor. By default, this item takes the standard value of the installed CPU. Increase the amount of voltage to enhance the overclocking capability. You can use the <+> or <-> keys to adjust the value. The values range from 0.001V to 0.999V with a 0.001V interval.

## **2.5.22 SVID Support [Auto]**

Set this item to [Enabled] when overclocking your system. Disabling this item stops the CPU from communicating with the external voltage regulator. Configuration options: [Auto] [Disabled] [Enabled]



---

The following item appears only when you set SVID Support to [Enabled].

---



## SVID Voltage Override [Auto]

This item allows you to set the SVID Voltage override. By default, this item takes the standard value of the installed CPU. You can use the <+> or <-> keys to adjust the value. The values range from 0.001V to 2.440 V with a 0.001 V interval.

### 2.5.23 CPU Input Voltage [Auto]

Allows you to set the input voltage for the CPU by the external voltage regulator. You can use the <+> or <-> keys to adjust the value. The values range from 0.800V to 2.700V with a 0.010V interval.

### 2.5.24 DRAM Voltage [Auto]

Allows you to set the DRAM Voltage. You can use the <+> or <-> keys to adjust the value. The values range from 1.20000V to 1.92000V with a 0.01000V interval.



---

According to Intel CPU specifications, DIMMs with voltage requirement over 1.65V may damage the CPU permanently. We recommend that you install the DIMMs with the voltage requirement below 1.65V.

---

### 2.5.25 PCH VLX Voltage [Auto]

This item allows you to set the I/O voltage on the PCH (Platform Controller Hub). You can use the <+> or <-> keys to adjust the value. The values range from 1.20000V to 2.00000V with a 0.01250V interval.

### 2.5.26 PCH Core Voltage [Auto]

This item allows you to set the core voltage on the PCH (Platform Controller Hub). You can use the <+> or <-> keys to adjust the value. The values range from 0.70000V to 1.50000V with a 0.01250V interval.



---

The system may need better cooling system for a more stable performance under high voltage settings.

---

### 2.5.27 DRAM CTRL REF Voltage [Auto]

This item allows you to set the DRAM reference voltage on the control lines from the memory bus. You can use the <+> or <-> keys to adjust the value. The values range from 0.39500V to 0.63000V with a 0.00500V interval.

### 2.5.28 DRAM DATA REF Voltage on CHA/CHB [Auto]

This item allows you to set the DRAM reference voltage on the data lines on Channels A and B. You can use the <+> or <-> keys to adjust the value. The values range from 0.39500V to 0.63000V with a 0.00500V interval.



---

To set a value for the DRAM reference voltage, we recommend you to set a value close to the standard value which is 0.500000x.

---

### 2.5.29 CPU Spread Spectrum [Auto]

This item allows you to enhance the BCLK overclocking capability or reduce the EMI (electromagnetic disturbance) generated by the BCLK. Set this item to [Enabled] for EMI reduction, or set this item to [Disabled] to enhance BCLK overclocking. Configuration options: [Auto] [Disabled] [Enabled]

## 2.6 Advanced menu

The Advanced menu items allow you to change the settings for the CPU and other system devices.



Be cautious when changing the settings of the Advanced menu items. Incorrect field values can cause the system to malfunction.

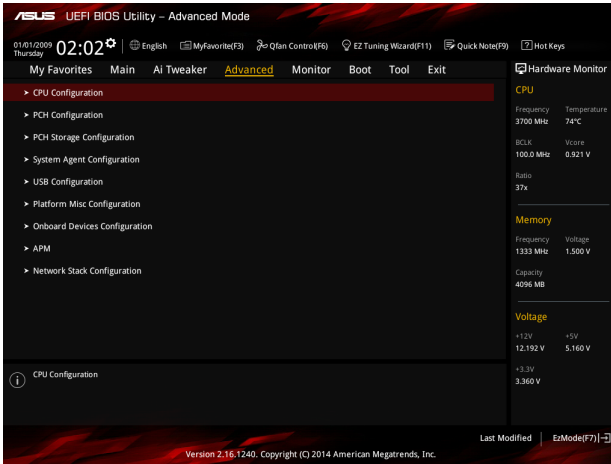

### 2.6.1 CPU Configuration

The items in this menu show the CPU-related information that the BIOS automatically detects.



The items shown in submenu may be different due to the CPU you installed.

#### Intel Adaptive Thermal Monitor [Enabled]

This item allows you to protect the CPU by decreasing its frequency as it reaches the thermal throttle point. The thermal monitor includes TM1 (Thermal monitor 1), TM2 (Thermal monitor 2), and EMTTM (Enhanced Multi-threaded Thermal Monitoring). Configuration options: [Disabled] [Enabled]

#### Hyper-threading [Enabled]

The Intel Hyper-Threading Technology allows a hyper-threading processor to appear as two logical processors to the operating system, allowing the operating system to schedule two threads or processes simultaneously.

[Enabled] Two threads per activated core are enabled.

[Disabled] Only one thread per activated core is enabled.

#### Active Processor Cores [All]

Allows you to choose the number of CPU cores to activate in each processor package. Configuration options: [All] [1] [2] [3]

### **Limit CPUID Maximum [Disabled]**

[Enabled] Allows legacy operating systems to boot even without support for CPUs with extended CPUID functions.

[Disabled] Disables this function.

### **Execute Disable Bit [Enabled]**

[Enabled] Enables the No-Execution Page Protection Technology.

[Disabled] Forces the XD feature flag to always return to zero (0).

### **Intel® Virtualization Technology [Disabled]**

[Enabled] Allows a hardware platform to run multiple operating systems separately and simultaneously, enabling one system to virtually function as several systems.

[Disabled] Disables this function.

### **Hardware Prefetcher (L2 Cache) [Enabled]**

[Enabled] Allows a hardware platform to automatically analyze the requirements and prefetch data and codes for the CPU.

[Disabled] Disables this function.

### **Adjacent Cache Line Prefetcher [Enabled]**

[Enabled] Allows a hardware platform to perform adjacent cache line prefetching.

[Disabled] Disables this function.

### **Boot performance mode [Max Non-Turbo Performance]**

This item allows you to select the boot performance mode. Configuration options: [Max Non-Turbo Performance] [Max battery] [Turbo Performance]

### **Dynamic Storage Accelerator [Disabled]**

This item allows you to accelerate the performance of the SSDs (Solid-State Drives) by dynamically adjusting the power management during heavy multitasking. Configuration options: [Enabled] [Disabled]

### **CPU Power Management Configuration**

This item allows you to manage and configure the CPU's power.

#### **Enhanced Intel SpeedStep Technology [Enabled]**

This item allows your system to adjust the CPU's voltage and cores frequency, resulting in decreased power consumption and heat production.

[Disabled] The CPU runs at its default speed.

[Enabled] The system controls the CPU speed.

#### **Turbo Mode [Enabled]**

This item allows you to automatically set the CPU cores to run faster than the base operating frequency when it is below the operating power, current and temperature specification limit. Configuration options: [Enabled] [Disabled]



---

Turbo Mode is only available on selected CPU models only.

---

## CPU C-States [Auto]

This item allows you to set the power saving of the CPU states. Configuration options: [Auto] [Disabled] [Enabled]



---

The following items appear only when you set the CPU C-States to **[Enabled]**.

---

### **Enhanced C1 state [Enabled]**

This item allows your CPU to reduce power consumption when the system is in idle mode. Configuration options: [Enabled] [Disabled]

### **CPU C3 Report [Enabled]**

This item allows you to disable or enable the CPU C3 report to the operating system. Configuration options: [Enabled] [Disabled]

### **CPU C6 Report [Enabled]**

This item allows you to disable or enable the CPU C6 report to the operating system. Configuration options: [Enabled] [Disabled]

### **C6 Latency [Short]**

This item allows you to set the duration of C6 latency for C6 state. Configuration options: [Short] [Long]

### **CPU C7 Report [CPU C7s]**

This item allows you to disable or enable the CPU C7 report to the operating system. Configuration options: [Disabled] [CPU C7] [CPU C7s]

### **C7 Latency [Long]**

This item allows you to set the duration of C7 latency for C7 state. Configuration options: [Short] [Long]

### **Package C-States Support [Auto]**

This item allows you to set the a C-state support for the CPU package. Configuration options: [Auto] [Enabled] [C0/C1] [C2] [C3] [C6] [CPU C7] [CPU C7s]

## CFG lock [Disabled]

Allows you to lock or unlock the CFG lock bit (bit 15 of MSR 0xE2). Configuration options: [Enabled] [Disabled]

## 2.6.2 PCH Configuration

### PCI Express Configuration

#### **PCI-E Speed [Auto]**

Allows you to select the PCI Express port speed. Configuration options: [Auto] [Gen1] [Gen2]

### Intel® Rapid Start Technology

#### **Intel® Rapid Start Technology [Disabled]**

Allows you to enable or disable Intel® Rapid Start Technology. Configuration options: [Enabled] [Disabled]



---

The following items appear only when you set the Intel® Rapid Start Technology to **[Enabled]**.

---

#### **Entry on S3 RTC Wake [Enabled]**

The system automatically wakes up and set to Rapid Start Technology S4 mode.  
Configuration options: [Enabled] [Disabled]

#### **Entry After [0]**

Allows you to set the wake-up time. The values range from 0 (immediately) to 120.

#### **Active Page Threshold Support [Enabled]**

The system automatically set itself to sleep when the partition size is not enough for Rapid Start Technology to work. Configuration options: [Enabled] [Disabled]

#### **Active Memory Threshold [0]**

Key in the value for the additional partition size for Rapid Start Technology to work.



---

Ensure that the caching partition size is larger than the total memory size.

---

#### **Hybrid Hard Disk Support [Disabled]**

Allows you to enable or disable hybrid hard disk support. Configuration options: [Enabled] [Disabled]

### **Intel® Smart Connect Technology [Disabled]**

#### **Intel Smart Connect Technology Support [Disabled]**

Allows you to enable or disable the Intel Smart Connect Technology support.  
Configuration options: [Enabled] [Disabled]

## **2.6.3 PCH Storage Configuration**

While entering Setup, the BIOS automatically detects the presence of SATA devices. The SATA Port items show Empty if no SATA device is installed to the corresponding SATA port.

### **M.2 SATA mode [Disabled]**

This item appears only when you installed a SATA M.2 SSD module and allows you to enable/disable M.2 SATA mode. Configuration options: [Disabled] [Enabled]

### **SATAExpress SRIS Support [Auto]**

This item allows you to set the SATAExpress SRIS support.

[Auto] The system automatically adjust the SRIS (Separate Reference Clock Independent Spread Spectrum Clocking Architecture) support for connected SATA Express devices.

[Disabled] Select this option for ASUS RUNWAY SATA Express bridge card.

### **SATA Mode Selection [AHCI]**

Allows you to set the SATA configuration.

[Disabled] Disables the SATA function.

[IDE] Set to [IDE] when you want to use the Serial ATA hard disk drives as Parallel ATA physical storage devices.

- [AHCI] Set to [AHCI] when you want the SATA hard disk drives to use the AHCI (Advanced Host Controller Interface). The AHCI allows the onboard storage driver to enable advanced Serial ATA features that increases storage performance on random workloads by allowing the drive to internally optimize the order of commands.
- [RAID] Set to [RAID Mode] when you want to create a RAID configuration from the SATA hard disk drives.

### **Aggressive LPM Support [Disabled]**

This item appears only when you set the previous item to [AHCI] or [RAID] and allows you to enable or disable PCH entering link power state aggressively. Configuration options: [Disabled] [Enabled]

### **S.M.A.R.T. Status Check [On]**

S.M.A.R.T. (Self-Monitoring, Analysis and Reporting Technology) is a monitor system. When read/write of your hard disk errors occur, this feature allows the hard disk to report warning messages during the POST. Configuration options: [On] [Off]

### **SATA6G\_1~6 (Gray) [Enabled]**

These items allow you to enable/disable the SATA ports. Configuration options: [Disabled] [Enabled]

### **Hot Plug [Disabled] (SATA6G\_1~6 [Gray])**

These items appear only when you set the SATA Mode Selection item to [AHCI] or [RAID] and allow you to enable/disable SATA Hot Plug Support. Configuration options: [Disabled] [Enabled]

## **2.6.4 System Agent Configuration**

### **VT-d [Disabled]**

Allows you to enable or disable VT-d function on MCH. Configuration options: [Enabled] [Disabled]

### **CPU Display Audio [Enabled]**

Allows you to enable or disable CPU SA Audio Device. Configuration options: [Enabled] [Disabled]

### **DVI Port Audio [Off]**

Allows you to enable or disable the DVI port. Configuration options: [On] [Off]

### **Graphics Configuration**

Allows you to select a primary display from CPU Graphics, PCIe and PCI graphical devices.

#### **Primary Display [Auto]**

Allows you to select which of the CPU Graphics/PCIe Graphics device should be the Primary Display. Configuration options: [Auto] [CPU Graphics] [PCIe] [PCI]

#### **DVMT Pre-Allocated for Haswell [Auto]**

Allows you to select the amount of system memory allocated to DVMT 5.0 used by the CPU Graphics. Configuration options: [Auto] [32M] [64M] [96M] [128M] [160M] [192M] [224M] [256M] [288M] [320M] [352M] [384M] [416M] [448M] [480M] [512M]

### **Render Standby [Auto]**

Allows you to enable or disable Intel® Graphics Render Standby support to reduce iGPU power use when the system is idle. Configuration options: [Auto] [Disabled] [Enabled]

### **CPU Graphics Multi-Monitor [Disabled]**

Allows you to enable the iGPU Multi-Monitor. For LucidLogix Virtu MVP function support, set this item to [Enabled] to empower both integrated and discrete graphics. The iGPU shared system memory size will be fixed at 64MB. Configuration options: [Disabled] [Enabled]

## **DMI Configuration**

Allows you to control various DMI functions.

### **DMI Gen 2 [Enabled]**

Allows you to enable or disable DMI Gen 2. Configuration options: [Enabled] [Disabled]

## **NB PCI-E Configuration**

Allows you to configure the NB PCI Express settings.

### **PCI-EX16\_1 Link Speed [Auto]**

Allows you to configure the PCI-EX16\_1 speed. Configuration options: [Auto] [Gen1] [Gen2] [Gen3]

### **PCI-EX16\_2 Link Speed [Auto]**

Allows you to configure the PCI-EX16\_2 speed. Configuration options: [Auto] [Gen1] [Gen2] [Gen3]

## **Memory Configuration**

### **Memory Scrambler [Enabled]**

Allows you to enable or disable Memory Scrambler support. Configuration options: [Enabled] [Disabled]

### **Memory Remap [Enabled]**

Allows you to enable or disable remapping the memory above 4GB.

[Enabled] Enables the function.

[Disabled] Disables this function.

## **2.6.5 USB Configuration**

The items in this menu allow you to change the USB-related features.



---

The **USB Devices** item shows the auto-detected values. If no USB device is detected, the item shows None.

---

## Legacy USB Support [Enabled]

- [Enabled] Enables the support for USB devices on legacy operating systems (OS).
- [Disabled] The USB devices can be used only for the BIOS setup program.
- [Auto] Allows the system to detect the presence of USB devices at startup. If detected, the USB controller legacy mode is enabled. If no USB device is detected, the legacy USB support is disabled.

## Intel® xHCI Mode [Smart Auto]

- [Auto] Keeps the last operation of xHCI controller in OS during bootup.
- [Smart Auto] Enables the operation of xHCI controller.
- [Enabled] Enables the function.
- [Disabled] Disables the function.

## EHCI Hand-off [Disabled]

- [Enabled] Enables the support for operating systems without an EHCI hand-off feature.
- [Disabled] Disables the function.

## USB Single Port Control

### USB3\_1~6, USB7~14 [Enabled]

Allows you to enable or disable an individual USB port. Refer to the section **1.2.3 Motherboard layout** in this user manual for the locations of the USB ports. Configuration options: [Enabled] [Disabled].

## 2.6.6 Platform Misc Configuration

The items in this menu allow you to configure the Platform Misc.

### PCI-E Native Power Management [Disabled]

Allows you to enhance the power saving feature of PCI Express and perform ASPM operations in the operating system. Configuration options: [Disabled] [Enabled]



---

The following item appears only when you set the PCI Express Native Power Management to **[Enabled]**.

---

### Native ASPM [Disabled]

- [Enabled] Windows® Vista OS controls the ASPM (active state power management) support for devices.
- [Disabled] BIOS controls the ASPM support for the device.

## PCH - PCI Express options

### DMI Link ASPM Control [Disabled]

This item allows you to control the Active State Power Management on both NB (NorthBridge) side and SB (SouthBridge) side of the DMI Link. Configuration options: [Disabled] [Enabled]



### **ASPM Support [Disabled]**

This item allows you to select the ASPM state for energy-saving conditions. Configuration options: [Disabled] [L0s] [L1] [L0sL1] [Auto]

### **SA - PCI Express options**

#### **DMI Link ASPM Control [Disabled]**

This item allows you to control the Active State Power Management on both CPU and PCH (platform controller hub) Both DMI link ASPM control items of the CPU and PCH sides must be enabled for the ASPM to take effect. Configuration options: [Disabled] [L0s] [L1] [L0sL1]

#### **PEG ASPM Support [Disabled]**

This item allows you to select the ASPM state for energy-saving conditions, or use the ASUS optimized energy saving profile. Configuration options: [Disabled] [ASPM L0s] [L1] [L0sL1] [Auto]

## **2.6.7 Onboard Devices Configuration**

### **HD Audio Controller [Enabled]**

[Enabled] Enables the HD Audio Device.

[Disabled] Disables the HD Audio Device.



---

The following item appears only when you set the **HD Audio Controller** item to [Enabled].

---

### **Front Panel Type [HD Audio]**

Allows you to set the front panel audio connector (AAFP) mode to legacy AC'97 or high-definition audio depending on the audio standard that the front panel audio module supports.

[HD Audio] Sets the front panel audio connector (AAFP) mode to high definition audio.

[AC97] Sets the front panel audio connector (AAFP) mode to legacy AC'97

### **SPDIF Out Type [SPDIF]**

[SPDIF] Sets to an SPDIF audio output.

[HDMI] Sets to an HDMI audio output.

### **SupremeFX Lighting LED [Enabled]**

Allows you to enable or disable the SupremeFX Lighting LED. Configuration options: [Enabled] [Disabled]

### **M.2 PCIe mode [Disabled]**

This item appears only when you installed a PCIe M.2 SSD module and allows you to enable/disable M.2 PCIe mode. Configuration options: [Disabled] [Enabled]

### **PCI-Express x16\_3 slot (Black) bandwidth [Auto]**

This item appears only when you set the M.2 PCIe mode item to [Disabled] and allows you to select the PCI-Express x16\_3 slot bandwidth. Configuration options: [Auto] [x2 mode] [x4 mode]

## Intel LAN Controller [Enabled]

Allows you to enable or disable the GbE controller. Configuration options: [Enabled] [Disabled]

## Intel LAN PXE Option ROM [Disabled]

This item only appears when the item Intel LAN Controller is set to [Enabled]. This item allows you to enable or disable the Intel PXE Option ROM. Configuration options: [Enabled] [Disabled]

## Serial Port Configuration

The sub-items in this menu allow you to set the serial port configuration.

### Serial Port [Enabled]

Allows you to enable or disable the serial port (COM). Configuration options: [Enabled] [Disabled]

### Change Settings [IO=3F8h; IRQ=4]

This item appears only when you set the **Serial Port** to [Enabled] and allows you to select the Serial Port base address. Configuration options: [IO=3F8h; IRQ=4] [IO=2F8h; IRQ=3] [IO=3E8h; IRQ=4] [IO=2E8h; IRQ=3]

## 2.6.8 APM

### ErP Ready [Disabled]

Allows you to switch off some power at S4+S5 or S5 to get the system ready for ErP requirement. When set to **[Enabled]**, all other PME options will be switched off. Configuration options: [Disabled] [Enabled (S4+S5)] [Enabled (S5)]

### Restore AC Power Loss [Power Off]

- [Power On] The system goes into on state after an AC power loss.
- [Power Off] The system goes into off state after an AC power loss.
- [Last State] The system goes into either off or on state, whatever the system state was before the AC power loss.

### Power On By PCI-E/PCI [Disabled]

- [Disabled] Disables the PCI-E/PCI devices to generate a wake-on-LAN feature of the Intel®/Realtek LAN device.
- [Enabled] Enables the PCI-E/PCI devices to generate a wake-on-LAN feature of the Intel®/Realtek LAN device.

### Power On By Ring [Disabled]

- [Disabled] Disables Ring to generate a wake event.
- [Enabled] Enables Ring to generate a wake event.

### Power On By RTC [Disabled]

- [Disabled] Disables RTC to generate a wake event.
- [Enabled] When set to [Enabled], the items **RTC Alarm Date (Days) and Hour/Minute/Second** will become user-configurable with set values.

## 2.6.9 Network Stack Configuration

### Network Stack [Disabled]

This item allows user to disable or enable the UEFI network stack. Configuration options: [Disabled] [Enabled]



---

The following two items appear only when you set the previous item to [Enabled].

---

### Ipv4 PXE Support [Enabled]

This item allows user to disable or enable the Ipv4 PXE Boot support. Configuration options: [Disable Link] [Enabled]

### Ipv6 PXE Support [Enabled]

This item allows user to disable or enable the Ipv6 PXE Boot support. Configuration options: [Disable Link] [Enabled]

## 2.7 Monitor menu

The Monitor menu displays the system temperature/power status, and allows you to change the fan settings.



Scroll down to display the following items:

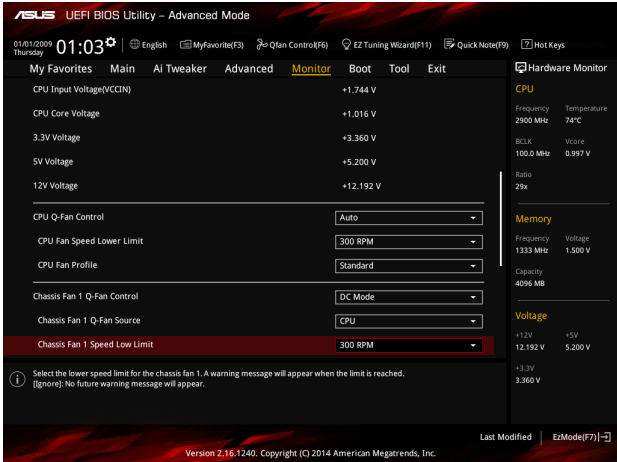

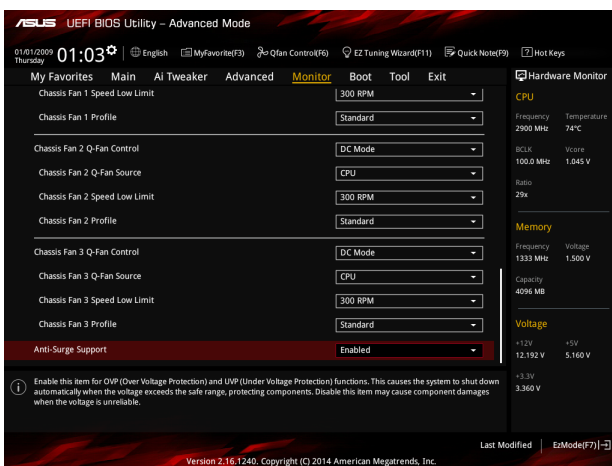

## 2.7.1 Qfan Tuning

Click this item to automatically detect the lowest speed and configure the minimum duty cycle for each fan.

## 2.7.2 CPU Temperature, MB Temperature, VRM Temperature, PCH CORE Temperature, SENSOR Temperature [xxx°C/xxx°F] or [Ignore]

The onboard hardware monitor automatically detects and displays the CPU / motherboard / VRM / PCH CORE / SENSOR temperatures. Select [Ignore] if you do not wish to display the detected temperatures.

## 2.7.3 CPU Fan Speed, CPU Optional Fan Speed, Chassis Fan 1 / Chassis Fan 2 / Chassis Fan 3 Speed [xxxx RPM] or [Ignore] / [Monitor]

The onboard hardware monitor automatically detects and displays the CPU Fan / CPU Optional Fan / Chassis fan 1, 2, and 3 speeds in rotations per minute (RPM). If the fan is not connected to the motherboard, the field shows N/A. Select Ignore if you do not wish to display the detected speed.

## 2.7.4 CPU Input Voltage (VCCIN), CPU Core Voltage, 3.3V Voltage, 5V Voltage, 12V Voltage

The onboard hardware monitor automatically detects the voltage output through the onboard voltage regulators. Select Ignore if you do not want to detect this item.

## 2.7.5 CPU Q-Fan Control [Auto]

- [Auto] Enables the CPU Q-Fan control for 4-pin CPU fan.
- [Disabled] Disables the CPU Q-Fan control feature.
- [PWM Mode] Enable the CPU Q-Fan control in PWM mode for 4-pin CPU fan.
- [DC Mode] Enable the CPU Q-Fan control in DC mode for 3-pin CPU fan.



---

The following items appear only when you set CPU Q-Fan Control to [Auto], [PWM Mode] or [DC Mode].

---

### CPU Fan Speed Low Limit [300 RPM]

This item appears only when you enable the CPU Q-Fan Control feature and allows you to disable or set the CPU fan warning speed. Configuration options: [Ignore] [200RPM] [300 RPM] [400 RPM] [500 RPM] [600 RPM]

### CPU Fan Profile [Standard]

This item appears only when you enable the CPU Q-Fan Control feature and allows you to set the appropriate performance level of the CPU fan.

- [Standard] Sets to [Standard] to make the CPU fan automatically adjust depending on the CPU temperature.
- [Silent] Sets to [Silent] to minimize the fan speed for quiet CPU fan operation.
- [Turbo] Sets to [Turbo] to achieve maximum CPU fan speed.
- [Manual] Sets to [Manual] to assign detailed fan speed control parameters.



---

The following four items appear only when you set CPU Fan Profile to [Manual].

---

### CPU Upper Temperature [70]

Use the <+> or <-> keys to adjust the upper limit of the CPU temperature. The values range from 25°C to 75°C.

### CPU Fan Max. Duty Cycle(%) [100]

Use the <+> or <-> keys to adjust the maximum CPU fan duty cycle. The values range from 20% to 100%. When the CPU temperature reaches the upper limit, the CPU fan operates at the maximum duty cycle.

### CPU Middle Temperature [45]

Use the <+> or <-> keys to set the value for CPU Middle Temperature. The range of the values depends on the CPU installed.

### CPU Fan Middle Duty Cycle(%) [60]

Use the <+> or <-> keys to adjust the CPU fan middle duty cycle. The values range from 60% to 100%. When the CPU temperature reaches the middle value, the CPU fan operates at the middle duty cycle.

### CPU Lower Temperature [40]

Use the <+> or <-> keys to adjust the CPU fan's lower temperature. The values range from 20% to 75%.

### CPU Fan Min. Duty Cycle(%) [60]

Use the <+> or <-> keys to adjust the minimum CPU fan duty cycle. The values range from 20% to 100%. When the CPU temperature is under 20°C, the CPU fan operates at the minimum duty cycle.

## 2.7.6 Chassis Fan 1/ Chassis Fan 2 / Chassis Fan 3 Q-Fan Control [DC Mode]

- [Disabled] Disables the chassis Q-Fan control feature.
- [PWM Mode] Enable the chassis Q-Fan control in PWM mode for 4-pin chassis fan.
- [DC Mode] Enable the chassis Q-Fan control in DC mode for 3-pin chassis fan.



The following items appear only when you set Chassis Fan 1/ Chassis Fan 2 / Chassis Fan 3 Q-Fan Control to [PWM Mode] or [DC Mode].

### Chassis Fan 1/ Chassis Fan 2/ Chassis Fan 3 Q-Fan Source [CPU]

This item allows you to control the assigned fan according to the selected temperature source. When select T\_SENSOR, plug a thermistor cable to T\_SENSOR header and stick it to the desired component as the temperature source. Configuration options: [CPU] [MB] [VRM] [PCH CORE] [T\_SENSOR]

### Chassis Fan 1/ Chassis Fan 2/ Chassis Fan 3 Speed Low Limit [300 RPM]

This item appears only when you enable the Chassis Fan Q-Fan Control feature and allows you to disable or set the chassis fan warning speed. Configuration options: [Ignore] [200RPM] [300 RPM] [400 RPM] [500 RPM] [600 RPM]

### Chassis Fan 1/ Chassis Fan 2/ Chassis Fan 3 Profile [Standard]

This item appears only when you enable the Chassis Fan 1/2/3/4 Q-Fan Control feature and allows you to set the appropriate performance level of the chassis fan 1/2/3/4.

- [Standard] Sets to [Standard] to make the chassis fan automatically adjust depending on the chassis temperature.
- [Silent] Sets to [Silent] to minimize the fan speed for quiet chassis fan operation.
- [Turbo] Sets to [Turbo] to achieve maximum chassis fan speed.
- [Manual] Sets to [Manual] to assign detailed fan speed control parameters.



The following four items appear only when you set Chassis Fan 1/2/3 Profile to [Manual].

### Chassis Fan 1/2/3 Upper Temperature [70]

Use the <+> or <-> keys to adjust the upper limit of the chassis temperature. The values range from 45°C to 75°C.

### Chassis Fan 1/2/3 Max. Duty Cycle(%) [100]

Use the <+> or <-> keys to adjust the maximum chassis fan duty cycle. The values range from 60% to 100%. When the chassis temperature reaches the upper limit, the chassis fan will operate at the maximum duty cycle.

**Chassis Fan 1/2/3 Middle Temperature [45]**

Use the <+> or <-> keys to set the value for Chassis Fan Middle Temperature.

**Chassis Fan 1/2/3 Middle Duty Cycle(%) [60]**

Use the <+> or <-> keys to adjust the chassis fan middle duty cycle. The values range from 60% to 100%.

**Chassis Fan 1/2/3 Lower Temperature [40]**

Use the <+> or <-> keys to adjust the chassis fans' lower temperature. The values range from 40% to 75%.

**Chassis Fan 1/2/3 Min. Duty Cycle(%) [60]**

Use the <+> or <-> keys to adjust the minimum chassis fan duty cycle. The values range from 60% to 100%. When the chassis temperature is under 40°C, the chassis fan operates at the minimum duty cycle.

**Allow Fan Stop [Disabled]**

This item allows you to enable to disable fan stop. Configuration options: [Enabled] [Disabled]

**2.7.7 Anti Surge Support [Enabled]**

This item allows you to enable or disable the Anti Surge function.  
Configuration options: [Disabled] [Enabled]



## 2.8 Boot menu

The Boot menu items allow you to change the system boot options.

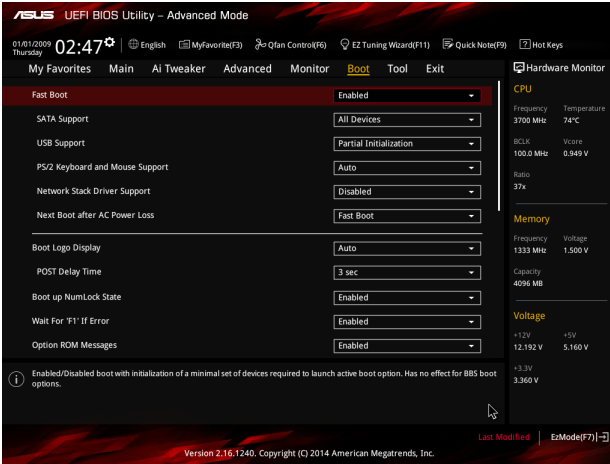

Scroll down to display the following items:

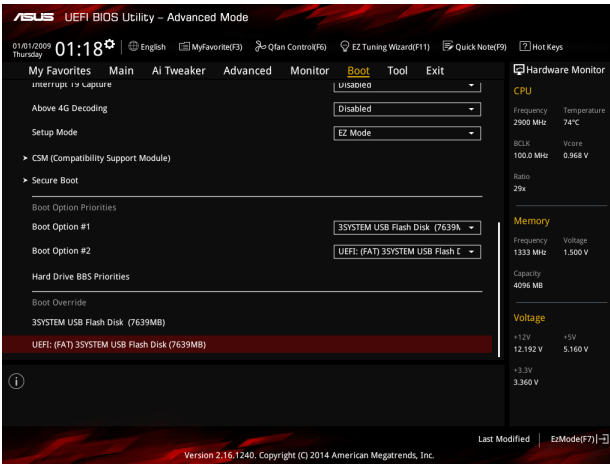

### 2.8.1 Fast Boot [Enabled]

[Enabled] Select to accelerate the boot speed.

[Disabled] Select to go back to normal boot.



The following five items appear when you set **Fast Boot** to [Enabled].

## SATA Support [All Devices]

- [All Devices] All devices connected to SATA ports will be available during POST. This process will extend the POST time.
- [Hard Drive Only] Only hard drives connected to SATA ports will be detected during POST. Any hardware change will disable fast boot.
- [Boot Drive Only] Only boot drive connected to SATA ports will be detected during POST. Any hardware change will disable fast boot.

## USB Support [Partial Initialization]

- [Disabled] All USB devices will not be available until OS boot up for a fastest POST time.
- [Full Initialization] All USB devices will be available during POST. This process will extend the POST time.
- [Partial Initialization] For a faster POST time, only the USB ports with keyboard and mouse connections will be detected.

## PS/2 Keyboard and Mouse Support [Auto]

Select any of these settings when PS/2 keyboard and mouse are installed. These settings only apply when Fast Boot is enabled.

- [Auto] For a faster POST time, PS/2 devices will only be available when the system boots up or rebooted when the PS/2 devices have not been reconnected or changed. If you disconnect or change PS/2 devices before restarting the system, PS/2 devices will not be available and BIOS setup program will not be accessible via PS/2 devices.
- [Full Initialization] For full system control, PS/2 devices will be available during POST at any circumstances. This process will extend POST time.
- [Disabled] For the fastest POST time, all PS/2 devices will not be available until your computer enters the operating system.

## Network Stack Driver Support [Disabled]

- [Disabled] Select to skip the network stack driver from loading during POST.
- [Enabled] Select to load the network stack driver during POST.

## Next Boot after AC Power Loss [Fast Boot]

- [Normal Boot] Returns to normal boot on the next boot after AC power loss.
- [Fast Boot] Accelerates the boot speed on the next boot after AC power loss.

## 2.8.2 Boot Logo Display [Auto]

- [Auto] Adjust automatically for Windows® requirement.
- [Full Screen] Maximize the boot logo size.
- [Disabled] Hide the logo during POST.

## POST Delay Time [3 sec]

This item appears only when you set **Boot Logo Display** to [Auto] or [Full Screen]. This item allows you to select the desired additional POST waiting time to easily enter the BIOS setup. You can only execute the POST delay time during Normal Boot. Configuration options: [0 sec] ~ [10 sec].



---

This feature will only work under normal boot.

---

## Post Report [5 sec]

This item appears only when you set **Boot Logo Display** to [Disabled]. This item allows you to select a desired post report waiting time. Configuration options: [1 sec] ~ [10 sec] [Until Press ESC].

## 2.8.3 Bootup NumLock State [Enabled]

[Enabled] Sets the power-on state of the NumLock to [Enabled].

[Disabled] Sets the power-on state of the NumLock to [Disabled].

## 2.8.4 Wait for 'F1' If Error [Enabled]

When this item is set to [Enabled], the system waits for the F1 key to be pressed when error occurs. Configuration options: [Disabled] [Enabled]

## 2.8.5 Option ROM Messages [Enabled]

[Enabled] The option ROM messages will be shown during the POST (power-on self-test).

[Disabled] Only the ASUS logo will be shown during the POST.

## 2.8.6 Interrupt 19 Capture [Disabled]

[Enabled] Allows the option ROMs to trap Interrupt 19.

[Disabled] Disables this function.

## 2.8.7 Above 4G Decoding [Disabled]

This item allows you to decode the 64-bit capable devices above 4G address space. Ensure that your system supports 64-bit PCI decoding. Configuration options: [Disabled] [Enabled]

## 2.8.8 Setup Mode [EZ Mode]

[Advanced Mode] Sets Advanced Mode as the default screen for entering the BIOS setup program.

[EZ Mode] Sets EZ Mode as the default screen for entering the BIOS setup program.

## 2.8.9 CSM (Compatibility Support Module)

Allows you to configure the CSM (Compatibility Support Module) items to fully support the various VGA, bootable devices, and add-on devices for better compatibility.

### Launch CSM [Enabled]

- [Auto] The system automatically detects the bootable devices and the add-on devices.
- [Enabled] For better compatibility, enable the CSM to fully support the non-UEFI driver add-on devices or the Windows® UEFI mode.
- [Disabled] Disable the CSM to fully support the Windows® Security Update and Security Boot.



---

The following four items appear when you set Launch CSM to [Enabled].

---

### Boot Device Control [UEFI and Legacy OPROM]

Allows you to select the type of devices that you want to boot up. Configuration options: [UEFI and Legacy OPROM] [Legacy OPROM only] [UEFI only]

### Boot from Network Devices [Legacy OPROM first]

Allows you to select the type of network devices that you want to launch. Configuration options: [Legacy OPROM first] [UEFI driver first] [Ignore]

### Boot from Storage Devices [Legacy OPROM first]

Allows you to select the type of storage devices that you want to launch. Configuration options: [Both, Legacy OPROM first] [Both, UEFI first] [Legacy OPROM first] [UEFI driver first] [Ignore]

### Boot from PCI-E/PCI Expansion Devices [Legacy OPROM first]

Allows you to select the type of PCI-E/PCI expansion devices that you want to launch. Configuration options: [Legacy OPROM first] [UEFI driver first]

## 2.8.10 Secure Boot

Allows you to configure the Windows® Secure Boot settings and manage its keys to protect the system from unauthorized access and malwares during POST.

### OS Type [Windows UEFI mode]

Allows you to select your installed operating system.

- [Windows UEFI mode] Executes the Microsoft® Secure Boot check. Only select this option when booting on Windows® UEFI mode or other Microsoft® Secure Boot compliant OS.
- [Other OS] Get the optimized function when booting on Windows® non-UEFI mode, Windows® Vista/XP, or other Microsoft® Secure Boot non-compliant OS. Only on Windows® UEFI mode that Microsoft® Secure Boot can function properly.



---

The following item appears when **OS Type** is set to [Windows UEFI mode].

---

### Key Management

Allows you to manage the Secure Boot keys.

### ***Install Default Secure Boot keys***

This item allows you to immediately load the default Security Boot keys, Platform key (PK), Key-exchange Key (KEK), Signature database (db), and Revoked Signatures (dbx). When the default Secure boot keys are loaded, the PK state will change from Unloaded mode to loaded mode.

### ***Clear Secure Boot keys***

This item appears only when you load the default Secure Boot keys. This item allows you to clear all default Secure Boot keys.

### ***Save Secure Boot Keys***

Allows you to save the PK (Platform Keys) to a USB storage device.

## **PK Management**

The Platform Key (PK) locks and secures the firmware from any non-permissible changes. The system verifies the PK before your system enters the OS.

### ***Delete PK***

Allows you to delete the PK from your system. Once the PK is deleted, all the system's Secure Boot keys will not be active. Configuration options: [Yes] [No]

### ***Load Default PK***

Select Yes to load the system default PK or select No to load a downloaded PK from a USB storage device.



---

The PK file must be formatted as a UEFI variable structure with time-based authenticated variable.

---

## **KEK Management**

The KEK (Key-exchange Key or Key Enrollment Key) manages the Signature database (db) and Revoked Signature database (dbx).



---

Key-exchange Key (KEK) refers to Microsoft® Secure Boot Key-Enrollment Key (KEK).

---

### ***Delete KEK***

This item allows you to delete the KEK from your system.

Configuration options: [Yes] [No]

### ***Load Default KEK***

Select Yes to load the system default KEK or select No to load a downloaded KEK from a USB storage device.

### ***Append Default KEK***

Select Yes to append the system default KEK or select No to append a downloaded KEK from a USB storage device.



---

The KEK file must be formatted as a UEFI variable structure with time-based authenticated variable.

---

## **DB Management**

The db (Authorized Signature database) lists the signers or images of UEFI applications, operating system loaders, and UEFI drivers that you can load on the single computer.

**Delete the db**

Allows you to delete the db file from your system. Configuration options:  
[Yes] [No]

**Load Default db**

Select Yes to load the system default db or select No to load a downloaded db from a USB storage device..

**Append Default db**

Select Yes to append the system default db or select No to append a downloaded db from a USB storage device.

**DBX Management**

The dbx (Revoked Signature database) lists the forbidden images of db items that are no longer trusted and cannot be loaded.

**Delete the dbx**

Allows you to delete the DBX file from your system. Configuration options:  
[Yes] [No]

**Load Default dbx**

Select Yes to load the system default dbx or select No to load a downloaded dbx from a USB storage device.

Configuration options: [Yes] [No]

**Append Default dbx**

Select Yes to append the system default dbx or select No to append a downloaded dbx from a USB storage device.



---

The DBX file must be formatted as a UEFI variable structure with time-based authenticated variable.

---

**2.8.11 Boot Option Priorities**

These items specify the boot device priority sequence from the available devices. The number of device items that appears on the screen depends on the number of devices installed in the system.



- To select the boot device during system startup, press <F8> when ASUS Logo appears.
  - To access Windows OS in Safe Mode, press <F8> after POST.
- 

**2.8.12 Hard Drive BBS Priorities**

Allows you to set the order of the legacy devices in this group.

**2.8.13 Boot Override**

These items displays the available devices. The number of device items that appear on the screen depends on the number of devices installed in the system. Click an item to start booting from the selected device.

## 2.9 Tool menu

The Tool menu items allow you to configure options for special functions. Select an item then press <Enter> to display the submenu.

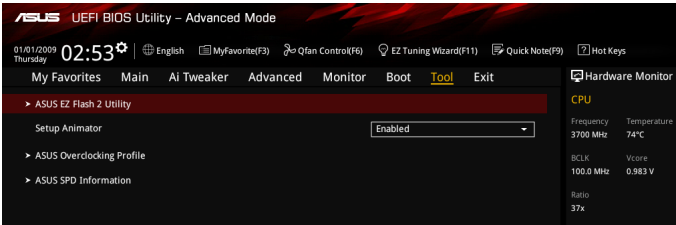

### 2.9.1 ASUS EZ Flash 2 Utility

Allows you to run ASUS EZ Flash 2. Press <Enter> to launch the ASUS EZ Flash 2 screen.



For more details, see section **ASUS EZ Flash 2**.

#### Setup Animator [Enabled]

This item allows you to enable or disable the Setup animator. Configuration options: [Disabled] [Enabled]

### 2.9.2 ASUS Overclocking Profile

This item allows you to store or load multiple BIOS settings.



The **Setup Profile Status** items show **Not Installed** if no profile is created.

#### Profile Name

Allows you to key in a profile name.

#### Save to Profile

Allows you to save the current BIOS settings to the BIOS Flash, and create a profile. Key in a profile number from one to eight, press <Enter>, and then select **Yes**.

#### Load Profile

Allows you to load the previous BIOS settings saved in the BIOS Flash. Key in the profile number that saved your CMOS settings, press <Enter>, and then select **Yes**.



- DO NOT shut down or reset the system while updating the BIOS to prevent the system boot failure!
- We recommend that you update the BIOS file only coming from the same memory/CPU configuration and BIOS version.

#### Load/Save CMOS Profile from/to USB Drive

Allows you to load/save CMOS profile from/to USB drive.

## 2.9.3 ASUS SPD Information

### DIMM Slot # [DIMM\_A1]

Displays the Serial Presence Detect (SPD) information of the DIMM module installed on the selected slot. Configuration options: [DIMM\_A1] [DIMM\_A2] [DIMM\_B1] [DIMM\_B2]

## 2.10 Exit menu

The Exit menu items allow you to load the optimal default values for the BIOS items, and save or discard your changes to the BIOS items. You can access the EZ Mode from the Exit menu.

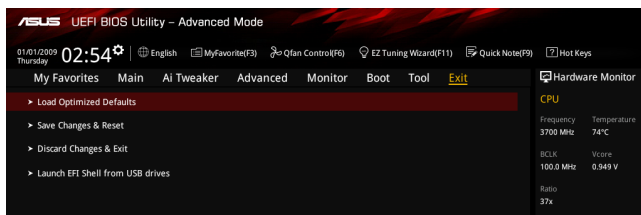

### Load Optimized Defaults

This option allows you to load the default values for each of the parameters on the Setup menus. When you select this option or if you press <F5>, a confirmation window appears. Select Yes to load the default values.

### Save Changes & Reset

Once you are finished making your selections, choose this option from the Exit menu to ensure the values you selected are saved. When you select this option or if you press <F10>, a confirmation window appears. Select Yes to save changes and exit.

### Discard Changes & Exit

This option allows you to exit the Setup program without saving your changes. When you select this option or if you press <Esc>, a confirmation window appears. Select Yes to discard changes and exit.

### Launch EFI Shell from USB drives

This option allows you to attempt to launch the EFI Shell application (shellx64.efi) from one of the available USB devices.



# Appendices

## Notices

### Federal Communications Commission Statement

This device complies with Part 15 of the FCC Rules. Operation is subject to the following two conditions:

- This device may not cause harmful interference.
- This device must accept any interference received including interference that may cause undesired operation.

This equipment has been tested and found to comply with the limits for a Class B digital device, pursuant to Part 15 of the FCC Rules. These limits are designed to provide reasonable protection against harmful interference in a residential installation. This equipment generates, uses and can radiate radio frequency energy and, if not installed and used in accordance with manufacturer's instructions, may cause harmful interference to radio communications. However, there is no guarantee that interference will not occur in a particular installation. If this equipment does cause harmful interference to radio or television reception, which can be determined by turning the equipment off and on, the user is encouraged to try to correct the interference by one or more of the following measures:

- Reorient or relocate the receiving antenna.
- Increase the separation between the equipment and receiver.
- Connect the equipment to an outlet on a circuit different from that to which the receiver is connected.
- Consult the dealer or an experienced radio/TV technician for help.



---

The use of shielded cables for connection of the monitor to the graphics card is required to assure compliance with FCC regulations. Changes or modifications to this unit not expressly approved by the party responsible for compliance could void the user's authority to operate this equipment.

---

### IC: Canadian Compliance Statement

Complies with the Canadian ICES-003 Class B specifications. This device complies with RSS 210 of Industry Canada. This Class B device meets all the requirements of the Canadian interference-causing equipment regulations.

This device complies with Industry Canada license exempt RSS standard(s). Operation is subject to the following two conditions: (1) this device may not cause interference, and (2) this device must accept any interference, including interference that may cause undesired operation of the device.

Cet appareil numérique de la Classe B est conforme à la norme NMB-003 du Canada.

Cet appareil numérique de la Classe B respecte toutes les exigences du Règlement sur le matériel brouilleur du Canada.

Cet appareil est conforme aux normes CNR exemptes de licence d'Industrie Canada. Le fonctionnement est soumis aux deux conditions suivantes :

- (1) cet appareil ne doit pas provoquer d'interférences et
- (2) cet appareil doit accepter toute interférence, y compris celles susceptibles de provoquer un fonctionnement non souhaité de l'appareil.

## Canadian Department of Communications Statement

This digital apparatus does not exceed the Class B limits for radio noise emissions from digital apparatus set out in the Radio Interference Regulations of the Canadian Department of Communications.

This class B digital apparatus complies with Canadian ICES-003.

## VCCI: Japan Compliance Statement

### VCCI Class B Statement

この装置は、クラスB情報技術装置です。この装置は、家庭環境で使用することを目的としていますが、この装置がラジオやテレビジョン受信機に近接して使用されると、受信障害を引き起こすことがあります。

取扱説明書に従って正しい取り扱いをして下さい。

VCCI-B

This is a Class B product based on the standard of the VCCI Council. If this is used near a radio or television receiver in a domestic environment, it may cause radio interference. Install and use the equipment according to the instruction manual.

## KC: Korea Warning Statement

B급 기기 (가정용 방송통신기자재)

이 기기는 가정용(B급) 전자파적합기기로서 주로 가정에서 사용하는 것을 목적으로 하며, 모든 지역에서 사용할 수 있습니다.

\*당해 무선설비는 전파혼신 가능성이 있으므로 인명안전과 관련된 서비스는 할 수 없습니다.

## REACH

Complying with the REACH (Registration, Evaluation, Authorisation, and Restriction of Chemicals) regulatory framework, we published the chemical substances in our products at ASUS REACH website at <http://csr.asus.com/english/REACH.htm>.



DO NOT throw the motherboard in municipal waste. This product has been designed to enable proper reuse of parts and recycling. This symbol of the crossed out wheeled bin indicates that the product (electrical and electronic equipment) should not be placed in municipal waste. Check local regulations for disposal of electronic products.



DO NOT throw the mercury-containing button cell battery in municipal waste. This symbol of the crossed out wheeled bin indicates that the battery should not be placed in municipal waste.

## ASUS Recycling/Takeback Services

ASUS recycling and takeback programs come from our commitment to the highest standards for protecting our environment. We believe in providing solutions for you to be able to responsibly recycle our products, batteries, other components as well as the packaging materials. Please go to <http://csr.asus.com/english/Takeback.htm> for detailed recycling information in different regions.

**English** AsusTek Inc. hereby declares that this device is in compliance with the essential requirements and other relevant provisions of CE Directives. Please see the CE Declaration of Conformity for more details.

**Français** AsusTek Inc. déclare par la présente que cet appareil est conforme aux critères essentiels et autres clauses pertinentes des directives européennes. Veuillez consulter la déclaration de conformité CE pour plus d'informations.

**Deutsch** AsusTek Inc. erklärt hiermit, dass dieses Gerät mit den wesentlichen Anforderungen und anderen relevanten Bestimmungen der CE-Richtlinien übereinstimmt. Weitere Einzelheiten entnehmen Sie bitte der CE-Konformitätserklärung.

**Italiano** AsusTek Inc. con la presente dichiara che questo dispositivo è conforme ai requisiti essenziali e alle altre disposizioni pertinenti alle direttive CE. Per maggiori informazioni fate riferimento alla dichiarazione di conformità CE.

**Колмання** ASUS заявляет, что это устройство соответствует основным требованиям и другим соответствующим условиям европейских директив. Подробную информацию, пожалуйста, смотрите в декларации соответствия.

**Български** С настоящото AsusTek Inc. декларира, че това устройство е в съответствие със съществените изисквания и другите приложими постановления на директивите CE. Вижте CE декларацията за съвместимост за повече информация.

**Hrvatski** AsusTek Inc. ovim izjavijuje da je ovaj uređaj sukladan s bitnim zahtjevima i ostalim odgovarajućim odredbama CE direktiva. Više pojedinosti potražite u CE izjavi o sukladnosti.

**Čeština** Společnost AsusTek Inc. tímto prohlašuje, že toto zařízení splňuje základní požadavky a další příslušná ustanovení směrnice CE. Další podrobnosti viz Prohlášení o shodě CE.

**Dansk** AsusTek Inc. Erklærer hermed, at denne enhed er i overensstemmelse med hovedkravene and andre relevante bestemmelser i CE-direktiverne. Du kan læse mere i CE-overensstemmelseserklæring.

**Nederlands** AsusTek Inc. verklaart hierbij dat dit apparaat compatibel is met de essentiële vereisten en andere relevante bepalingen van CE-richtlijnen. Raadpleeg de CE-verklaring van conformiteit voor meer details.

**Eesti** Käesolevaga kinnitab AsusTek Inc., et see seade vastab CE direktiivide olulistele nõuetele ja teisteles asjakohastele sätetele. Vt üksikasju CE vastavusdeklaratsioonist.

**Suomi** AsusTek Inc. vakuuttaa täten, että tämä laite on CE-direktiivien olennaisten vaatimusten ja muiden asiaan kuuluvien lisäysten mukainen. Katso lisätietoja CE-vaatimustenmukaisuusvakuutuksesta.

**Ελληνικά** Με το παρόν, η AsusTek Inc. δηλώνει ότι αυτή η συσκευή συμμορφώνεται με τις θεμελιώδεις απαιτήσεις και άλλες σχετικές διατάξεις των Οδηγιών της ΕΕ. Για περισσότερες λεπτομέρειες ανατρέξτε στην Δήλωση Συμμόρφωσης ΕΕ.

**Magyar** Az AsusTek Inc. ezennel kijelenti, hogy a készülék megfelel a CE-irányelvek alapvető követelményeinek és ide vonatkozó egyéb rendelkezéseinek. További részletekért tekintse meg a CE-megfelelőségi nyilatkozatot.

**Latviski** Līdz ar šo AsusTek Inc. paziņo, ka šī ierīce atbilst būtiskajām prasībām un citiem saistošajiem nosacījumiem, kas norādīti CE direktīvā. Lai uzzinātu vairāk, skatiet CE Atbilstības deklarāciju.

**Lietuvių** Šiuo dokumentu bendrovė „AsusTek Inc.“ pareiškia, kad šis įrenginys atitinka pagrindinius CE direktyvų reikalavimus ir kitas susijusias nuostatas. Daugiau informacijos rasite CE atitikties deklaracijoje.

**Norsk** AcerTek Inc. erklærer herved at denne enheten er i samsvar med hovedsaklige krav og andre relevante forskrifter i CE-direktiver. Du finner mer informasjon i CE-samsvarserklæringen.

**Polski** Niniejszym AsusTek Inc. deklaruje, że to urządzenie jest zgodne z istotnymi wymaganiami oraz innymi powiązanymi zaleceniami Dyrektyw CE. W celu uzyskania szczegółów, sprawdź Deklarację zgodności CE.

**Português** A AsusTek Inc. declara que este dispositivo está em conformidade com os requisitos essenciais e outras disposições relevantes das Diretivas da CE. Para mais detalhes, consulte a Declaração de Conformidade CE.

**Română** Prin prezenta, AsusTek Inc. declară faptul că acest dispozitiv respectă cerințele esențiale și alte prevederi relevante ale directivei CE. Pentru mai multe detalii, consultați declarația de conformitate CE.

**Srpski** AsusTek Inc. ovim izjavijuje da je ovaj uređaj u saglasnosti sa ključnim zahtjevima i drugim relevantnim odredbama CE Direktiva. Molimo vas, pogledajte CE Deklaraciju o usklađenosti za više detalja.

**Slovensky** Spoločnosť AsusTek Inc. týmto prehlasuje, že toto zariadenie vyhovuje príslušným požiadavkám a ďalším súvisiacim ustanoveniam smernice ES. Viac podrobností si pozrite v prehlásení o zhode ES.

**Slovenščina** AsusTek Inc. tukaj izjavlja, da je ta naprava skladna s temeljnimi zahtevami in drugimi relevantnimi določili direktiv CE. Za več informacij glejte Izjavo CE o skladnosti.

**Español** Por la presente, AsusTek Inc. declara que este dispositivo cumple los requisitos básicos y otras disposiciones relevantes de las directivas de la CE. Consulte la Declaración de conformidad de la CE para obtener más detalles.

**Svenska** AsusTek Inc. förklarar härmed att denna enhet är i överensstämmelse med de grundläggande kraven och andra relevanta bestämmelser i CE-direktiven. Se CE-försäkran om överensstämmelse för mer information.

**Українська** AsusTek Inc. заявляє, що цей пристрій відповідає основним вимогам відповідних Директив ЄС. Будь ласка, див. більше подробиць у Декларації відповідності нормам ЄС.

**Türkçe** AsusTek Inc., bu aygıtın temel gereksinimlerle ve CE Yönergelerinin diğer ilgili koşullarıyla uyumlu olduğunu beyan eder. Daha fazla ayrıntı için lütfen CE Uygunluk Beyanına bakın.

**Bosanski** AsusTek Inc. ovim potvrđuje da je ovaj uređaj uskladen s osnovnim zahtjevima i drugim relevantnim propisima Direktiva EK. Za više informacija molimo pogledajte Deklaraciju o usklađenosti EK.

## ASUS contact information

### ASUSTeK COMPUTER INC.

Address 15 Li-Te Road, Peitou, Taipei, Taiwan 11259  
Telephone +886-2-2894-3447  
Fax +886-2-2890-7798  
E-mail [info@asus.com.tw](mailto:info@asus.com.tw)  
Web site <http://www.asus.com>

#### **Technical Support**

Telephone +86-21-3842-9911  
Fax +86-21-5866-8722 ext. 9101#  
Online support <http://support.asus.com/techserv/techserv.aspx>

### ASUS COMPUTER INTERNATIONAL (America)

Address 800 Corporate Way, Fremont, CA 94539, USA  
Telephone +1-510-739-3777  
Fax +1-510-608-4555  
Web site <http://www.asus.com/us/>

#### **Technical Support**

Support fax +1-812-284-0883  
General support +1-812-282-2787  
Online support <http://www.service.asus.com/>

### ASUS COMPUTER GmbH (Germany and Austria)

Address Harkort Str. 21-23, D-40880 Ratingen, Germany  
Fax +49-2102-959931  
Web site <http://www.asus.com/de>  
Online contact <http://eu-rma.asus.com/sales>

#### **Technical Support**

Telephone +49-2102-5789555  
Support Fax +49-2102-959911  
Online support <http://www.asus.com/de/support/>



# EC Declaration of Conformity

Who, the undersigned,

Manufacturer: ASUSTeK COMPUTER INC.  
 4F, No. 150, LI TE RD, PEITOU, TAIPEI 112, TAIWAN  
 Authorized representative in Europe: ASUS COMPUTER GmbH  
 Address, City: HARKORT STR. 21-23, 40860 RATINGEN  
 Country: GERMANY

declare the following apparatus:

Product name : Motherboard  
 Model name : Z97-PRO GAMER

conform with the essential requirements of the following directives:

- 2004/108/EC-EMC Directive
- EN 55022:2010(AAC:2011)
- EN 55024:2010(AAC:2011)
- EN 55019:2010(AAC:2012:02:2006)
- 1989/EC-RATE Directive
- EN 300 353 V1.7 (2005-10)
- EN 300 440-1 V1.6 (2010-08)
- EN 300 440-2 V1.6 (2010-08)
- EN 300 451 V1.9A (2010-01-08)
- EN 301 908-1 V6.2 (2011-05)
- EN 301 908-2 V6.2 (2011-07)
- EN 301 908-3 V6.2 (2011-07)
- EN 302 544-2 V1.1 (2009-01)
- EN 302 623 V1.1 (2009-01)
- EN 302 325-3 V1.3 (2007-06)
- EN 302 325-2 V1.1 (2006-07)
- EN 302 291-1 V1.1 (2006-07)
- EN 302 291-2 V1.1 (2006-07)

- 2009/59/EC-LVD Directive
- EN 60950-1: A122011
- 2009/125/EC-EP Directive
- Regulation (EC) No. 1275-2008
- Regulation (EC) No. 642/2009
- 2011/65/EU-REACH Directive
- CE marking

- EN 300 489-1 V1.9 (2011-09)
- EN 301 489-3 V1.4 (2010-08)
- EN 301 489-4 V1.4 (2010-08)
- EN 301 489-7 V1.4 (2010-08)
- EN 301 489-9 V1.4 (2010-11)
- EN 301 489-10 V2.2 (2012-09)
- EN 301 489-11 V2.2 (2012-09)
- EN 302 325-3 V1.3 (2007-06)
- EN 302 325-2 V1.1 (2006-07)
- EN 302 291-1 V1.1 (2006-07)
- EN 302 291-2 V1.1 (2006-07)
- EN 60950-1: A122011
- Regulation (EC) No. 2762/2009
- Regulation (EC) No. 617/2013

Ver. 14031



(EC conformity marking)

Position : CEO  
 Name : Jerry Shen

Signature : \_\_\_\_\_

Declaration Date: 15/10/2014  
 Year to begin affixing CE marking: 2014

# DECLARATION OF CONFORMITY

Per FCC Part 2 Section 2.1077(a)



Responsible Party Name: Asus Computer International  
 Address: 800 Corporate Way, Fremont, CA 94539

Phone/Fax No: (510)739-3777/(510)608-4555

hereby declares that the product

Product Name : Motherboard  
 Model Number : Z97-PRO GAMER

Conforms to the following specifications:

- FCC Part 15, Subpart B, Unintentional Radiators

### Supplementary Information:

This device complies with part 15 of the FCC Rules. Operation is subject to the following two conditions: (1) This device may not cause harmful interference, and (2) This device must accept any interference received, including interference that may cause undesired operation.

Representative Person's Name : Steve Chang / President

Signature :

Date : Oct. 15, 2014

Ver. 14031

---

---

---

---

---

---

---

---

---

---

---

---

---

---

---

---

---

---

---

---

---

---

---

---

---

---

---

---

---

---