

THE GATALOG PRESENTS



FG9 MK II

POWERED BY WEAPONIZED AUTISM™

Published by

The GataLog
April 16th, 2021

Document version: 1.4

Author of this document:

JStark1809

E-Mail: JStark1809@protonmail.com

Co-Designers of the FGC-9 MkII:

JStark1809

IvanTheTroll

3socksandcrocs

Website: <https://thegatalog.com/>

Special thanks to:

- An unnamed individual
- All members, fans and supporters of Deterrence Dispensed
- Designers whose creations inspired and influenced the FGC-9 MKII
- In particular Derwood for coming up with the Shuty AP9 design,
on which the FGC-9 MkI and FGC-9 MkII core mechanisms are based on

SAFETY ADVISORY



When firing your FGC-9 MkII always take proper safety precautions!

Wear safety glasses, hearing protection, and keep your hands away from the ejection port of your FGC-9 MkII when shooting.

Don't use damaged or defective ammo. Always inspect your ammo before loading it into your FGC-9 MkII. Be sure the ammo is proper 9x19mm.

The FGC-9 MkII is a safe and reliable firearm only when made properly with the latest specifications and instructions that are detailed in this guide.

Do not blindly use components and materials in your FGC-9 MkII without first having made sure their dimensions and properties fulfill the intended design specifications of the latest available FGC-9 MkII guide.

It is important to realize that the FGC-9 is an improvised firearm. Thus, it lacks some of the safety features that modern firearms have in trade-off for easier manufacturability by individuals that lack the access to advanced tools and firearm fabrication skills.

To eliminate potential issues right from the beginning, thoroughly read this guide multiple times, especially the [Troubleshooting section](#) on page 178 onwards.

It is utmost critical to understand the shortcomings of this improvised design and how to ensure safe and reliable function regardless of the lack of modern safety features.

You must read and understand especially [this](#) section!

Contents

Technical specifications and features	5
Message from the author	7
3D-Printing	8
Tools, materials and parts	18
Materials	22
Fire control group components	29
General parts	30
Recommended accessories	36
Ammunition	37
Visual overview of the components	39
Making the barrel	40
Suppressor	42
Making the charging handle	47
Making the firing pin	51
Melting in the thread inserts	66
Making the bolt	68
Drilling the lower bolt rod	69
Welded Bolt Option	74
Weldless Bolt Option	92
Drilling the charging handle recess	110
Preparing the Fire control group	114
Modifying Chinese Glock Mag Springs	124
Assembling a magazine	128
Assembling the lower	131
Assembling the barrel assembly	144
Assembling the upper	147
Assembling the stock assembly	154
Main assembly	158
Testing cartridge feeding	163
Adjusting the firing pin protrusion	168
Final bolt assembly	173
Test firing and maintenance	175
Troubleshooting	178
Troubleshooting Failures to Extract	179
Firing Pin Troubleshooting	183
Troubleshooting Feeding Issues	186
Out-of-battery discharge	194

Technical specifications and features

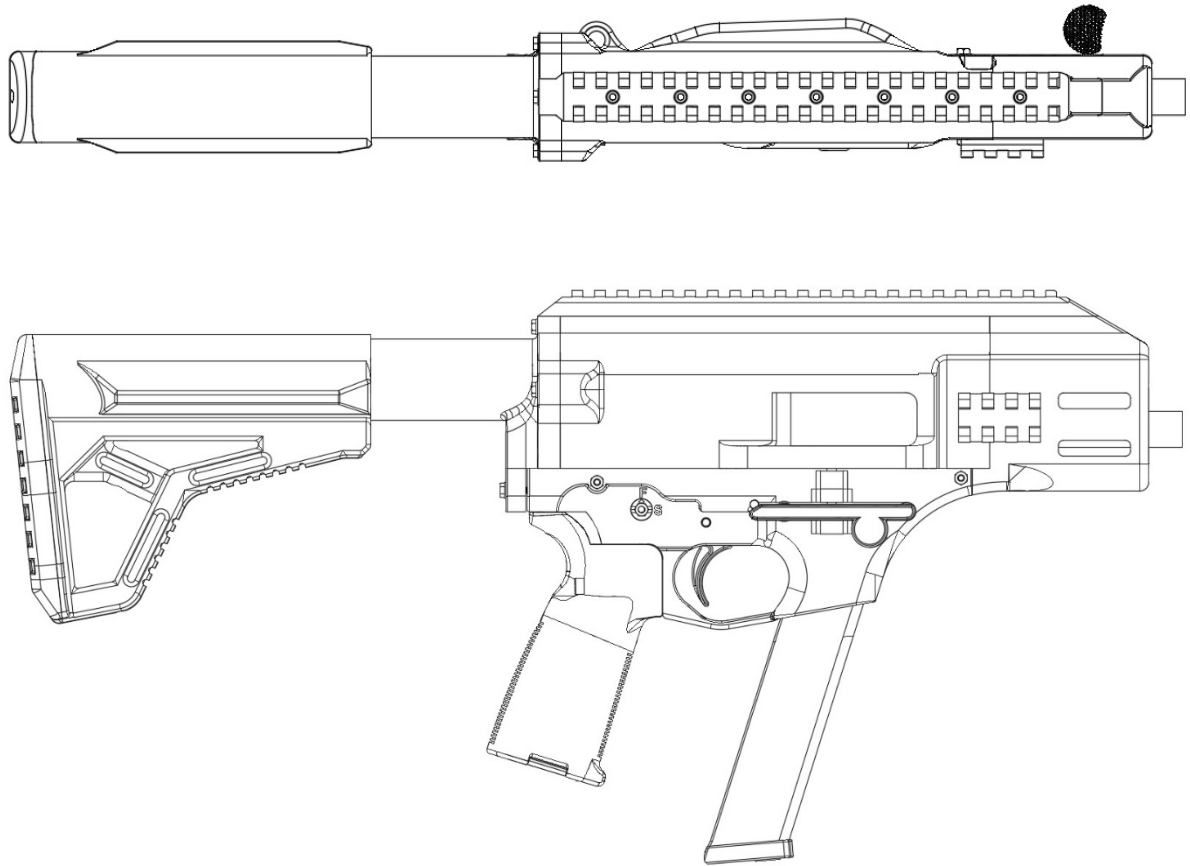

FGC-9 MkII

Type: Pistol caliber carbine

Designers: JStark1809, IvanTheTroll, 3socksandcross

Designed: 2020-2021

Mass(without magazine): 2.2kg

Length: 520mm

Barrel length: 114mm

Cartridge: 9x19mm Parabellum

Action: Closed bolt straight blowback

Feed system: 25 round box magazine, 33 rounds with OEM Glock magazines

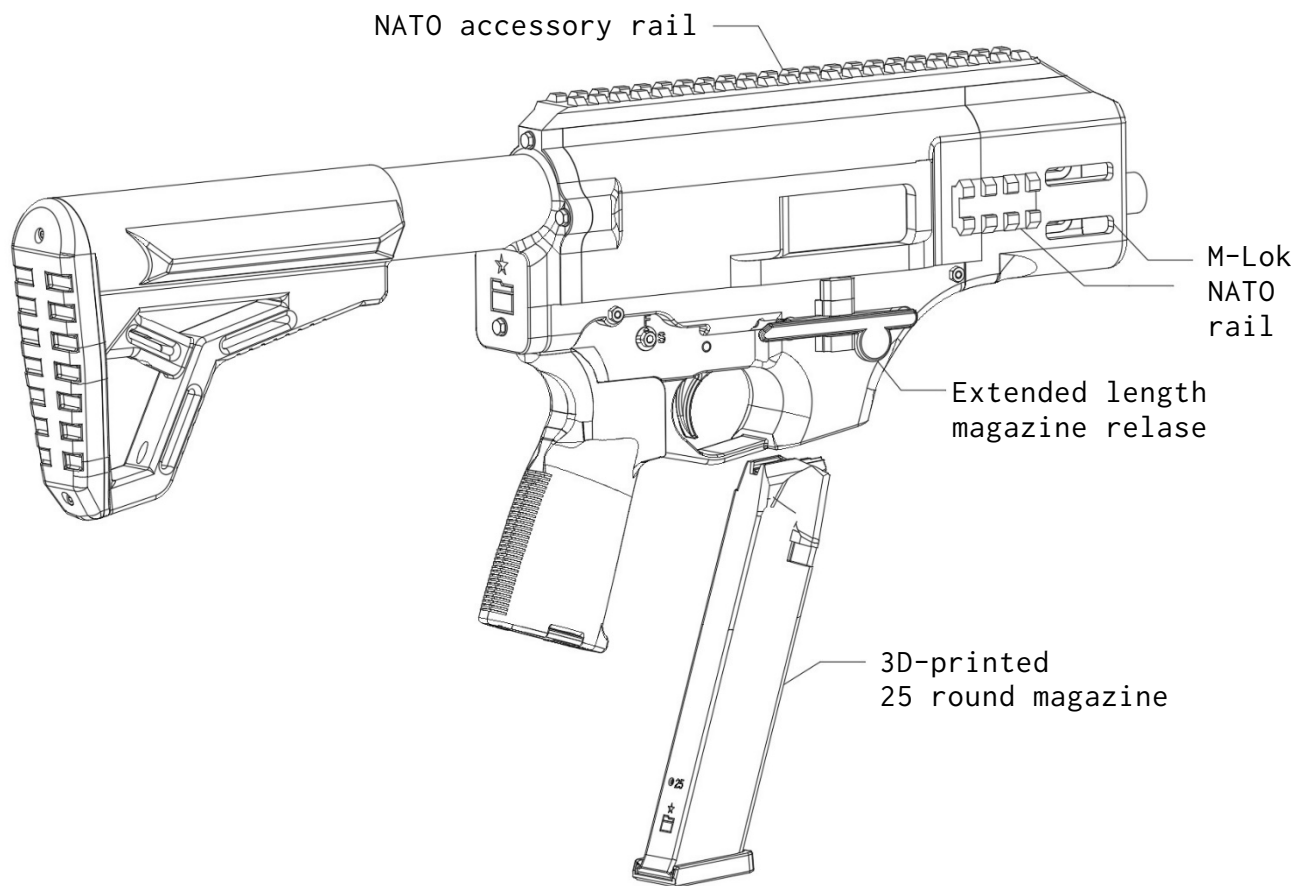
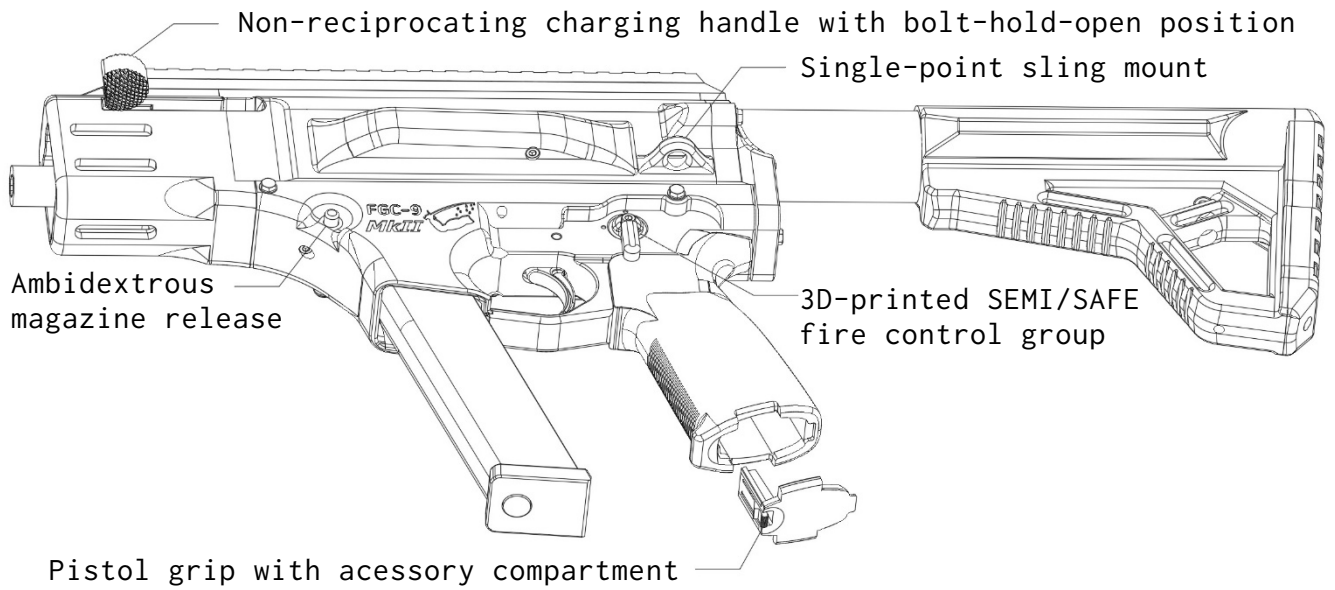

Message from the author

*“What we do now,
echoes in eternity”*

– Marcus Aurelius

I hope that you appreciate the time and effort that was put into this project as well as the risks that were involved.

If you had success in producing your FGC-9 or simply appreciate the effort of empowering the common man with firearms, consider donating to the developers of this project.

Even a tiny donation will be appreciated. Any funds donated help with future developments and improvements.

DONATION LINKS:

JStark1809

Bitcoin donation page:

<https://ctrlpew.com/donate-to-jstark/>

XMR(Monero) Address:

[424fanLpuQXTR65cFG7WD3VM4dfi1bGC9ffKM7
cwY7u6adQLT9oXsKcisZibmoa5Jv1
GNmuNCXhi9ezWjGsCTcjJTfieKJZ](https://ctrlpew.com/donate-to-jstark/)

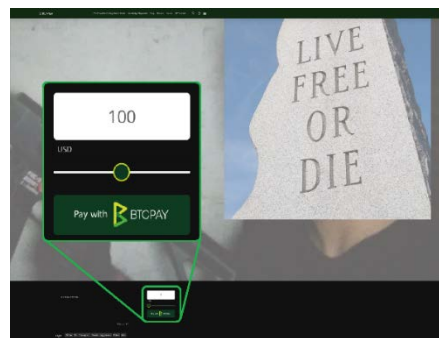

IvanTheTroll

<https://ctrlpew.com/donate-to-ivanthetroll/>

Donation links of other developers of the community:

<https://ctrlpew.com/donate/>

<https://defcad.com/partners>

3D-Printing

If you have never used a 3D-printer before and/or have never owned one refer to appropriate guides for beginners that include recommendations on what 3D-printer to buy and further relevant information:

- <https://www.youtube.com/watch?v=JTN6jtB5mqk>
- <https://www.enbloccpress.com/guide/>
- <https://ctrlpew.com/the-complete-getting-started-guide/>

Once you've figured out how to print basic things that you can download from sites like thingiverse.com, you can go ahead.

The next pages contain the general suggested settings for your printed parts. You can deviate from these settings based on your 3D-printer, consistency of PLA filament and general experience with 3D-printing.

These settings were optimized for [Creality Ender 3](#) printers in combination with the use of the [Cura slicer program \(V4.8.0\)](#).

The FGC-9 was designed to be printed in PLA or PLA+.
Printing it in a material other than this could result in an unreliable, fragile or unsafe firearm. Consider this your warning!

Recommended Filament type: PLA (Recommended PLA brands on [page 22](#))
Nozzle size: 0.40mm
Layer height: 0.16mm
Infill density: 100% (99% when using Cura, for shorter print time)
Nozzle temperature: 230°C +-5°C
Bed temperature: 60°C

The orientation of the parts in the slicer program will load up as intended. Do not change the orientation of the .stl models inside your slicer program unless you know what you're doing.

For Cura users, another recommended settings change is on [page 17](#).

After printing each part, make sure to get rid of any edges and artifacts that result out of the nature of 3D-printing. Before you install any 3D-printed components make sure to insert and remove items from their destined place on the receiver multiple times to make sure that they move smoothly if they are intended to do so, which is the case, for example, for the bolt housing. So if a part does not fit or move in the manner you would expect, try to smoothen the surface of the 3D-printed object and get rid of any squished edges with your craft knife.





Do not re-use any parts that you may have from a FGC-9 MkI build. All components have undergone changes, thus re-using MkI parts may lead to malfunctions and less than ideal operation of your gun.



Printed parts list

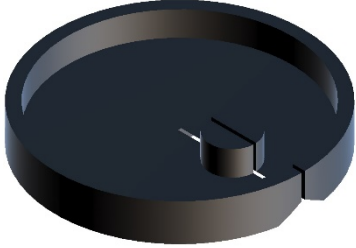

Use this section as a checklist to ensure you've printed all parts.

	Charging Handle
	Fan Speed: 100%
	Generate Support: <input checked="" type="checkbox"/> Support Overhang Angle: 45°
	Build Plate Adhesion Type: Skirt
	NOTE:
	Charging Handle Bushing
	Fan Speed: 100%
	No support
	Build Plate Adhesion Type: Brim
	NOTE:
	Barrel Retainer
	Fan Speed: 80%
	Generate Support: <input checked="" type="checkbox"/> Support Overhang Angle: 85°
	Build Plate Adhesion Type: Brim
	NOTE:

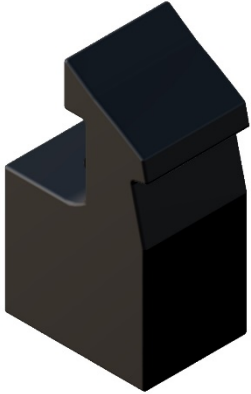

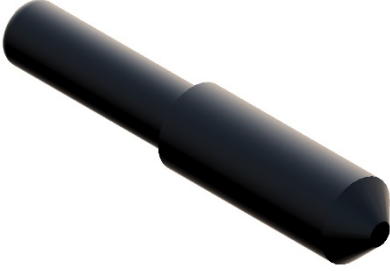
	Drilling Jig Solid Half
	Fan Speed: 100%
	No support
	Build Plate Adhesion Type: Brim
	NOTE:
	Drilling Jig Hole Half
	Fan Speed: 100%
	No support
	Build Plate Adhesion Type: Brim
	NOTE:
	Recess Jig
	Fan Speed: 100%
	No support
	Build Plate Adhesion Type: Brim
	NOTE:
	Headspacing Jig
	Fan Speed: 100%
	No support
	Build Plate Adhesion Type: Brim
	NOTE:
	Only for this part Infill Density: 20%

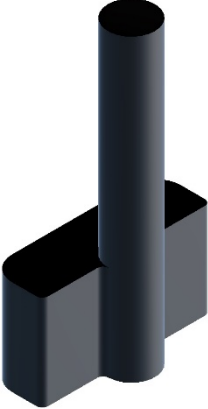
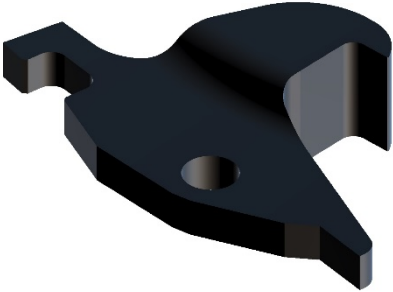
	Welding Jig
	Fan Speed: 100%
	No support
	Build Plate Adhesion Type: Skirt
	NOTE:
	<i>Only print for weld option</i>
	Bolt Housing
	Fan Speed: 50%
	Generate Support: <input checked="" type="checkbox"/> Support Overhang Angle: 85°
	Build Plate Adhesion Type: Brim
	NOTE:
	<i>Only print for weld option</i>
	Weldless Bolt Grinding Jig
	Fan Speed: 80%
	No support
	Build Plate Adhesion Type: Brim
	NOTE:
	<u>Only print for weldless option</u> Needs to be printed twice(2x)
	Weldless Bolt Housing
	Fan Speed: 50%
	Generate Support: <input checked="" type="checkbox"/> Support Overhang Angle: 85°
	Build Plate Adhesion Type: Brim
	NOTE:
	<i>Only print for weldless option</i>

	Feed Ramp
	Fan Speed: 50%
	No support
	Build Plate Adhesion Type: Skirt
	NOTE:
	Ejector
	Fan Speed: 0% / OFF
	No support
	Build Plate Adhesion Type: Skirt
	NOTE:
	Magazine Catch Bar
	Fan Speed: 100%
	No support
	Build Plate Adhesion Type: Skirt
	NOTE:
	Magazine Catch Button
	Fan Speed: 100%
	Generate Support: <input checked="" type="checkbox"/> Support Overhang Angle: 45°
	Build Plate Adhesion Type: Brim
	Only for this part, Support X/Y Distance: 0.5mm REVERT BACK TO DEFAULT VALUE AFTER YOU PRINTED THIS PART!

	Magazine Catch Pivot Pin
	Fan Speed: 100%
	No support
	Build Plate Adhesion Type: Brim
	NOTE:
	Disconnecter
	Fan Speed: 20%
	Generate Support: <input checked="" type="checkbox"/> Support Overhang Angle: 75°
	Build Plate Adhesion Type: Brim
	NOTE:
	Fire Selector Drum
	Fan Speed: 20%
	No support
	Build Plate Adhesion Type: Brim
	NOTE:
	Fire Selector Lever
	Fan Speed: 20%
	Generate Support: <input checked="" type="checkbox"/> Support Overhang Angle: 75°
	Build Plate Adhesion Type: Brim
	NOTE:

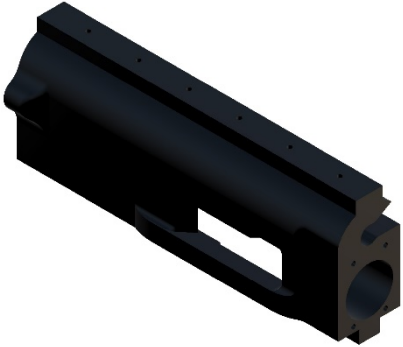
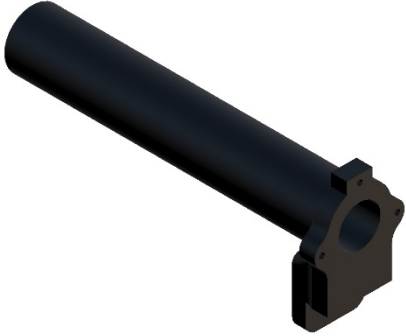
	Hammer
	Fan Speed: 20%
	Generate Support: <input checked="" type="checkbox"/> Support Overhang Angle: 75°
	Build Plate Adhesion Type: Brim
	NOTE:
	Trigger
	Fan Speed: 20%
	Generate Support: <input checked="" type="checkbox"/> Support Overhang Angle: 75°
	Build Plate Adhesion Type: Brim
	NOTE:
	Pistol Grip Lid
	Fan Speed: 100%
	Generate Support: <input checked="" type="checkbox"/> Support Overhang Angle: 75°
	Build Plate Adhesion Type: Brim
	NOTE:
	Pistol Grip
	Fan Speed: 80%
	Generate Support: <input checked="" type="checkbox"/> Support Overhang Angle: 85°
	Build Plate Adhesion Type: Brim
	NOTE:

	Lower Receiver
	Fan Speed: 50%
	Generate Support: <input checked="" type="checkbox"/> Support Overhang Angle: 85°
	Build Plate Adhesion Type: Brim
	NOTE:
	Upper Receiver
	Fan Speed: 50%
	Generate Support: <input checked="" type="checkbox"/> Support Overhang Angle: 80°
	Build Plate Adhesion Type: Brim
	NOTE:
	Buffer Tube
	Fan Speed: 50%
	Generate Support: <input checked="" type="checkbox"/> Support Overhang Angle: 85°
	Build Plate Adhesion Type: Brim
	The support rod printed with this part should be kept on hand, as it will be used in the assembly of the firearm.
	Stock
	Fan Speed: 80%
	No support
	Build Plate Adhesion Type: Brim
	NOTE:

	Buttplate
	Fan Speed: 80%
	No support
	Build Plate Adhesion Type: Skirt
	NOTE:
	Top Rail
	Fan Speed: 0% / OFF
	No support
	Build Plate Adhesion Type: Brim
	NOTE:
	Magazine Locking Tab
	Fan Speed: 35%
	No support
	Build Plate Adhesion Type: Brim
	NOTE:
	Magazine Base Plate
	Fan Speed: 35%
	No support
	Build Plate Adhesion Type: Brim
	NOTE:

	Magazine Follower
	Fan Speed: 35%
	Generate Support: <input checked="" type="checkbox"/> Support Overhang Angle: 75°
	Build Plate Adhesion Type: Brim
	NOTE:
	Magazine Body
	Fan Speed: 0%
	NO Support
	Build Plate Adhesion Type: Brim
	NOTE: Only for this part, Wall Line Count: 8 REVERT BACK TO DEFAULT VALUE AFTER YOU PRINTED THIS PART!

If you use Cura, make sure that you deactivate the following setting for all parts: “Use Adaptive Layers” -> (Unchecked/Deactivated)

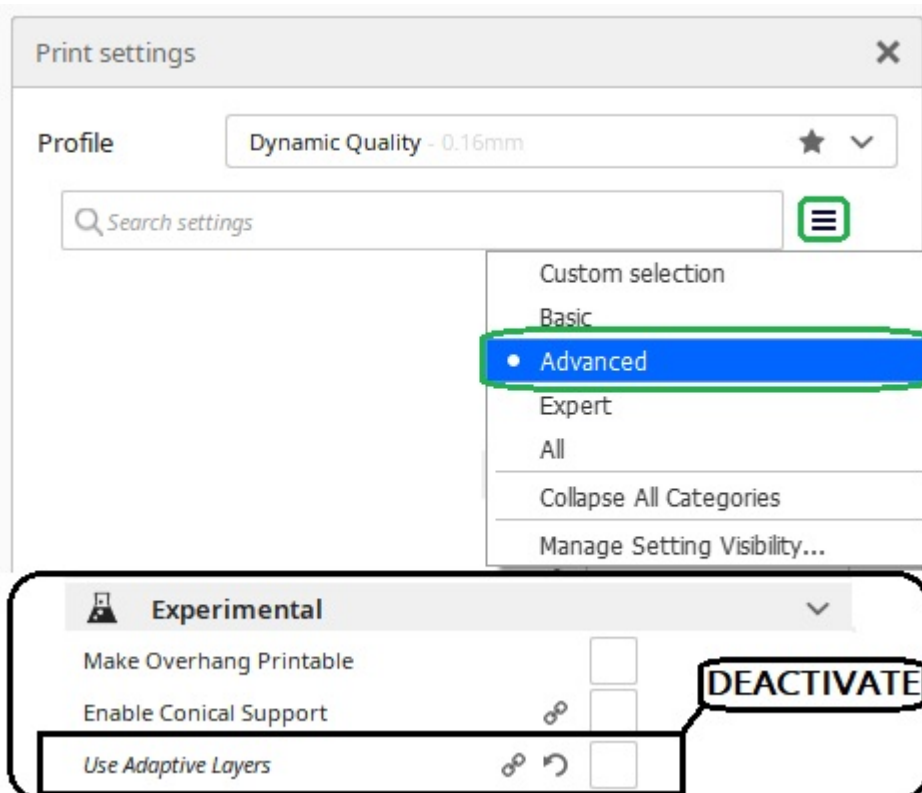

Tools, materials and parts

NOTE: A 3D-Printer and related tools are assumed to be already in your possession

Tools

Digital caliper



- A digital caliper that is able to give you accurate measurements

It should be able to display the measurements in millimeters

It is recommended that you buy a high quality caliper such as: Mitutoyo 500-196-30

Recommended source: Amazon, Ebay, Aliexpress, Local hardware store

Vise



- A proper full-size vise mounted to a sturdy table

Recommended source: Amazon, Ebay, Local hardware store

Power drill



- A power drill

Ideally it should be made by a good manufacturer and be as powerful as possible

Recommended source: Amazon, Ebay, Aliexpress, Local hardware store

Extra long 3.5mm drill bit



- HSS-Cobalt drill bit set with sizes:
1mm, 1.5mm, 2mm, 2.5mm, 3mm, 3.5mm, 4mm,
4.5mm, 5mm, 5.5mm, 6mm, 6.5mm, 7mm,
7.5mm, 8mm, 8.5mm, 9mm, 9.5mm, 10mm

The alloy the drill bits are made out of needs to be:

At least:

HSS-Cobalt M35 (5% Cobalt)

Ideally:

HSS-Cobalt M42 (8% Cobalt)

Recommended source: Amazon, Local hardware store

Extra long 3.5mm drill bit



- 3.5mm HSS drill bit with a length of at least 110mm, ideally longer

Ideally HSS-Cobalt

Recommended source: Amazon, Local hardware store

Metric socket and bit driver set



- A driver and wrench set that contains metric socket heads and metric hex bits

Recommended source: Amazon, Local hardware store

Metal file



- You need at least one metal file, ideally, you'd get a set of files

The metal file should have a 1 or 2 cut ideally

This means it should have a fairly coarse checkering pattern

Recommended source: Amazon, Ebay, Local hardware store, Aliexpress

Safety glasses



- Safety glasses to protect you especially during usage of the angle grinder

Recommended source: Amazon, Ebay, Local hardware store

Angle grinder



- Vital to make cutting thicker steel stock manageable

Make sure to buy the appropriate metal cutting disc for your angle grinder

Recommended source: Amazon, Local hardware store

Dremel tool/Rotary Rool



- Dremel or rotary tool with various inserts. You have to buy the appropriate metal cutting discs!

Metal cutting discs may also be included when purchasing the tool from Chinese brands. Make sure to check.

Recommended source: Amazon, Local hardware store, Aliexpress

Soldering iron



- Needed to melt the thread inserts into the upper receiver

Any soldering iron will work, ideally you have access to various tips, of which one should work better for the job

Recommended source: Amazon, Ebay, Local hardware store, Aliexpress, Banggood

Needle-Nose pliers



- Nose pliers for bending wire

Recommended source: Amazon, Local hardware store

Wire cutters



- Wire cutter to cut steel wire

Recommended source: Amazon, Local hardware store

Slot screw driver



- Any slot screw driver of small to medium size is appropriate. This will be used to help you remove supports on the 3D-printed parts

Recommended source: Local hardware store

Craft knife



- This will be used to help you remove supports and print imperfections on the 3D-printed parts

Recommended source: Local arts and craft store, Local hardware store

Tool with a handle smaller in diameter than 12mm



- During the production of the firing pin spring you will need a tool to push against the firing pin. Use any tool that has a handle with a mean diameter of less than 12mm, to push into the back of the bolt assembly. Read the pin protrusion adjustment pages to make sense of this.

Materials

PLA filament



- 2x 1kg spools of 1.75mm diameter
Regular PLA filament (black)

Recommended brands:

Chinese:
Hatchbox, eSUN, Sunlu

European:
Prusament, DasFilament, 3DJake

American:
Fusion Filament, 3DFuel, Atomic Filament

Use standard matte black filament as it is produced and used the most, thus the scrutiny in terms of feedback on the quality by the customer is higher on the black PLA of any particular brand

Store sealed as long as possible

Round steel stock (18mm,3mm)



- 1x 50mm long and 1x 216mm long
or one piece longer than 300mm,
18mm diameter ± 0.1 mm

(Ideally you'll have multiple of those pieces in case you make mistakes or want to make multiple bolts. So buy a round steel stock bar of 18mm diameter that is longer than 300mm at least, and then cut it with your angle grinder into pieces as you need it)

- 1x 200mm long or as a longer piece,
3mm diameter ± 0.01 mm

IMPORTANT FOR BOTH: The round steel stock has to be non-hardened, so no tool steel for example! Uncoated! Use carbon steel (regular steel)! Any other steels are not recommended. For the $\varnothing 3$ mm stock, stainless steel is acceptable.

Recommended source: Ebay, Local industrial metal supplier

JB Weld



- 2x packages of JB Weld

This is a two-part epoxy that is used to glue materials of all sorts together especially metals. Get the regular JB weld version

If you can't get JB weld try to find a similar product that is a two-part steel bonding epoxy/glue

Recommended source: Amazon, Ebay, Local hardware store

Threadlocking fluid 243/242



- Small bottle of Loctite 243/242

Recommended source: Amazon, Local Hardware store, AliExpress (Last resort)

AliExpress link:

[aliexpress.com/item/4000015095892.html](https://www.aliexpress.com/item/4000015095892.html)

Sand paper



- Get multiple sheets of coarse to medium grain sand paper

Recommended source: Local hardware store, Amazon, Ebay

Razor blades



- At least 1x disposable thin razor blade

This is potentially needed to install the 3mm shaft collars in case they come with slot instead of hex key screws

Recommended source: Local grocery store, Local drug store

Cutting fluid



- At least 1x spray can or bottle of cutting fluid

It is used to cool and lubricate during drilling, threading and other processes that remove metal

Recommended source: Amazon, Ebay, Local hardware store

Grease



- 1x small container of grease for mechanical lubrication applications

Recommended source: Amazon, Ebay, Local hardware store

Tooth picks



- 1x small container of tooth picks

This will be used to mix and apply JB Weld

Recommended source: Grocery store, Local drug store, Local hardware store

Welded Bolt specific tools and materials (ONLY NEEDED FOR WELDED BOLT OPTION):

Sheet metal plates



- 1x 3-5mm thick sheet metal plate, at least 500x500mm big

Put that plate on any regular table to have a table ready to be used for your welding

You will need that sheet metal plate on top of a regular table in case you don't have a welding table that has been specifically made for welding

- 1x 1mm thick sheet metal plate, at least 700x700mm big. Put that plate on the floor around the part of the regular table you will weld to protect the floor.

- 1x 3-5mm thick, 20mm wide sheet metal strip cut to 100mm length to help you align the bolt pieces during welding

NOTE: These sheet metal materials are not necessary but highly recommended if you are new to welding and did not have the facilities and tools to weld.

Recommended source: Ebay, Local industrial metal supplier

Stick welding electrodes



- Assortment of welding electrodes

Ideally 2.5mm in diameter.

BUY DIFFERENT TYPES OF STICK WELDING ELECTRODES FROM DIFFERENT BRANDS!

Some steel welding electrodes might work better than others for the steel you are working with. This is key.

Recommended source: Amazon, Ebay, Local hardware store.

Stick welding unit



- A cheap and simple stick welding unit that is also known as SMAW(Shielded Metal Arc Welding) or simply arc welding unit

They can cost from anywhere between 50 and 100 USD

Recommended source: Amazon, Ebay, Aliexpress, Local hardware store

Welding helmet



- A welding helmet is important to have to be able to weld without going blind

Recommended source: Amazon, Ebay, Aliexpress, Local hardware store

Welding gloves



- Purpose made leather gloves to prevent burning your hands during welding

Recommended source: Amazon, Ebay, Local hardware store

Welding apron



- An apron to protect you against burning yourself while welding. Made out of leather or leather substitute

Recommended source: Amazon, Ebay, Local hardware store

Welding clamps



- 1-2x welding clamps to help you during the welding of the bolt. Make sure the welding clamp is of the type you see in the picture

Recommended source: Amazon, Ebay, Aliexpress

Slag hammer



- Hammer to help you get rid of the slag that forms during the welding process

Recommended source: Amazon, Ebay, Aliexpress

Metal wire brush



- Brush with metal wires to help you clean welding seams

Recommended source: Amazon, Ebay, Aliexpress

Weldless Bolt specific materials (ONLY NEEDED FOR WELDLESS BOLT OPTION):

Extra 3mm drill bit

- At least one extra 3mm drill bit



Square steel stock

- Square steel stock 10x10mm
Get a bar of at least 100mm length.



Woodworking clamp

- A woodworking clamp that is similar to the example in the picture



Recommended source: Ebay, Amazon,
Hardware store

Fire control group components

In regards to the fire control group you have two options.

For most people the FGC-9 is intended to be built by, you will most likely rely on the printed fire control group but if you have access to proper firearm parts it is recommended you buy a commercial AR-15/M4/M16 compatible fire control group. A proper commercially made AR-15 fire control group will be safer and vastly more reliable. So if you can get one, go with a proper AR-15 fire control group. Depending on your choice, you will have to buy different parts.

Parts for use with the 3D-printed FGC-9 MkII fire control group:



In order of image shown above, from left to right:

- 1x AR-15 Hammer spring
- 1x Steel Dowel Pin, 4mm diameter, 28mm +/-2mm long, Recommended Spec/Type: DIN 6325 or DIN 7
- 1x AR-15 Trigger spring
- 1x AR-15 Fire control group pin
- 1x AR-15 Disconnect spring
- 1x AR-15 Fire selector spring
- 1x AR-15 Fire selector detent

AR-15 parts available from Aliexpress:

www.aliexpress.com/item/32916890199.html

www.aliexpress.com/item/1005001538560272.html (21 pcs option)

www.aliexpress.com/item/33008262340.html (T070 option)

www.aliexpress.com/item/33018833744.html (21 pcs option)

www.aliexpress.com/item/1005001451650916.html

Buy 4mm diameter, 28mm long pin on Ebay/Fastener Shop/Aliexpress

Additionally, 1x Slot head screw and 1x Socket head screw are needed for the 3D-printed fire control group. Info is on the next pages.

General parts

Shaft collars DIN 705



- 3x Shaft collars DIN 705, 16mm
Inner diameter: 16mm
Outer diameter: 28mm
Width: 12mm

- 1x Shaft collar DIN 705, 3mm
Inner diameter: 3mm
Outer diameter: 7mm
Width: 5mm
(Should include a set screw)

Alternatively, equivalent shaft collar:
Inner diameter: 3mm
Outer diameter: 7mm-12mm
Width: 5mm

Recommended source: Ebay, Regional online fastener supplier

Cup point set screws DIN 916



- 3x Set Screw M6 DIN 916, 6mm

Recommended source: Ebay, McMaster, Regional online fastener supplier

Main Buffer Spring



- 1x AR-15/M4 Buffer Spring

Recommended source: Aliexpress, Ebay

Available on Aliexpress:

www.aliexpress.com/item/33050087682.html
www.aliexpress.com/item/4001109286597.html
www.aliexpress.com/item/4001053158030.html

Firing Pin Spring Stock



- 1x Compression spring

Outer diameter: 6mm
Wire thickness: 1mm
Initial length: 25mm +-1mm

Recommended source: Ebay, AliExpress, McMaster

McMaster Link(Option for Americans):
<https://www.mcmaster.com/8969T748/>

You will cut this spring stock into a firing pin spring later on when you have nearly completed your FGC-9 build.

Mag Catch Spring



- 1x AR-15 Mag Catch spring

(Most likely already included in your fire control group spring kit ordered from Aliexpress)

Cut shorter at your own preference as the mechanism might be too stiff at full length

OR

- 1x Compression spring

Outer diameter: 7mm
Wire thickness: 0.5mm
Length/Cut to length: 20mm

Secondary Buffer Spring



- 1x Compression spring:

Outer diameter: 17mm
Wire thickness: 2mm +-0.5mm
Length: 80mm +-10mm

DIN 2095 option: Outer diameter:17mm
Wire thickness: 2.25mm
Length: 75mm

Recommended source: Ebay, AliExpress

Available on Aliexpress:

www.aliexpress.com/item/4000436939383.html
www.aliexpress.com/item/1005001633110330.html

Hex head screws DIN 933

- 6x Hex Head Screw M3 DIN 933, 40mm
- 4x Hex Head Screw M3 DIN 933, 20mm



Recommended source: Ebay, McMaster,
Regional online fastener supplier

Socket head screw DIN 912



DIN 912 Socket Head Screws:

- 10x Socket Head Screw M3, 16mm
- 1x Socket Head Screw M3, 20mm
- 1x Socket Head Screw M3, 12mm
- 1x Socket Head Screw M3, 30mm
Cut to 28mm length
(Only needed for the 3D-printable
Fire Control Group)
- 1x Socket Head Screw M4, 30mm
- 1x Socket Head Screw M6, 25mm

Recommended source: Ebay, McMaster,
Regional online fastener supplier

Slot head screw DIN 84



- 1x Slot Head Screw M4 DIN 84, 6mm
(Only needed for 3D-printable fire
control group)

Recommended source: Ebay, McMaster,
Regional online fastener supplier

Washers DIN 125

- 10x Washer M3 DIN 125

Recommended source: Ebay, McMaster,
Regional online fastener supplier



Nuts DIN 934

- 4x Nuts M3 DIN 934

Recommended source: Ebay, McMaster,
Regional online fastener supplier



Lock washer DIN 6797

- 1x External-Tooth Lock Washer M6 DIN 6797

Recommended source: Ebay, McMaster,
Regional online fastener supplier



Thread inserts



- 4x SL-Type M3 Thread Inserts
"Brass Hot Melt Inset Nuts SL-Type"

M3 Thread, Diameter: 5mm, Length: 7mm

"M3 X D5.0 X L7.0"

Available on Aliexpress and Ebay:

[aliexpress.com/item/4000232858343.html](https://www.aliexpress.com/item/4000232858343.html)
[aliexpress.com/item/4000826134336.html](https://www.aliexpress.com/item/4000826134336.html)

OR

Generic Thread Inserts M3
(With diagonal knurling)
Outer diameter: 5mm
Width/Length: 5-7mm

Extended G17 Mag Springs



- (7x+) 1x per Mag that you want to make

Available from Aliexpress:

www.aliexpress.com/item/4000036186924.html
("For G17/Color B" Option)

<https://www.aliexpress.com/item/4001268513095.html> ("Glock 17" Option)

<https://www.aliexpress.com/item/4000845210385.html> ("Glock 17" Option)

NOTE: These springs are only compatible
with 17rd and 25rd
3D-printed magazines

With high likelihood you will need to
modify the springs before they work in the
25rd 3d-printed FGC-9 MkII magazine.

The modification guide is on page: [128](#)

Hex/Allen L-Key Size 5mm

- 1x 5mm Hex/Allen L-Key



Recommended source: Ebay, McMaster, Regional online fastener supplier

You might have to cut the longer leg to meet these dimensions:

Overall length: 82.5mm \pm 2.5mm
Short leg: 25mm+

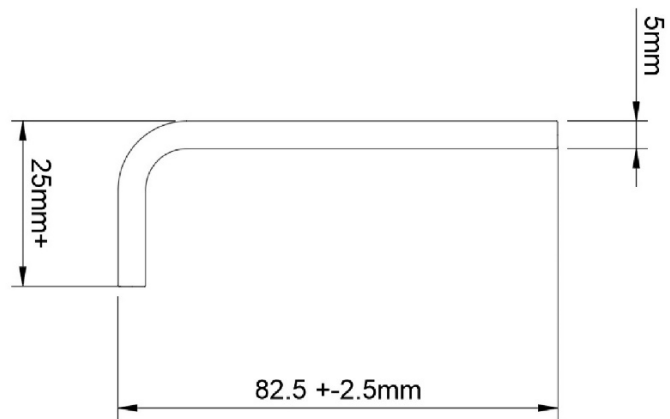

Neodymium Magnet

- 1x Neodymium Magnet 20mmx10mmx2mm

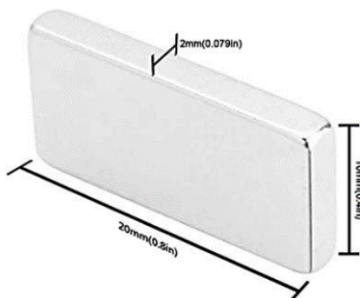

Recommended source: Ebay, Amazon

Recommended accessories

Silicone spray



- Silicone lubricant spray for the surface of all 3D-printed parts that interact with each other

Recommended source: Ebay, McMaster, Regional online fastener supplier

Gun oil/lubricant AND Cleaning kit



- Lubricant: NATO S-761/ NATO S-758/ W18
Important to prevent rust inside barrel
Source: Ebay, Amazon, Car oil shops

- 9mm cleaning kit
Example link: [AliExpress](#)

NOTE: DON'T USE THE COPPER WIRE BRUSH TIP

Red dot sight



- Red dot sight
Suggested option:

<https://www.aliexpress.com/item/4000310643707.html>

9x19mm Laser Bore Sighter



- 9x19mm Laser Bore Sighter

Use to roughly adjust your sight without needing to fire. Adjust your sight with it to a distance of 10,25 or 50 meters.
Watch Youtube tutorials for instructions.

Recommended budget option: [Banggood](#)

Weapon mounted flashlight



- Weapon mounted flashlight
Suggested option:

<https://www.aliexpress.com/item/32864902300.html>

Single point bungee sling



- Ideal sling for the FGC-9 MkII
Suggested option:

<https://www.aliexpress.com/item/10000348332759.html>

Ammunition

You will most likely not have access to 9x19mm ammunition, thus you will need to assemble/reload your own 9x19mm cartridges.

Europeans at time of the publication of this document, are still able to buy all necessary components and tools without the need for any licenses.

For assembly/reloading you will need reloading tools.

Included with the files is a guide written by IvanTheTroll that explains how to assemble your cartridges with improvised tools, but if you are able to buy the reloading tools, you should use the proper reloading tools instead for reliability and faster production rates.

The following components are needed for 9x19mm cartridges:



Projectile



Case



Primer



Source of Powder

To help you find these components in the case that you live in Europe, use the following terms in your search:

- Projectiles, Shipped from Czech Republic, Austria or Germany:
(9mm/.355/.356) ".355 FMJ RN" or "9mm FMJ RN"
- Cases, Shipped from Poland: "Łuski 9x19mm" or "Łusek 9mm"
Cases, Shipped from Germany: "Hülsen 9mm" or "Hülsen 9mm gebraucht"
Cases, Shipped from UK: "Deactivated 9x19mm"
Cases, Shipped from Czech Republic: "Nábojnice 9mm"
- Small Pistol Primers, Shipped from Italy: "Inneschi primers IT"
- 6.8/11 **RED** HILTI blanks: "Hilti 6.8/11 Red"
*Contain 0.23grams / 3.5 grains of NC powder per blank !
Buy hundreds at least, better thousands if you can !*

NOTE: If you are unable to acquire proper primers, you will need to resort to reloading the "indented" / already fired primers inside old cartridge cases. This means, if you can't buy primers you will need to make sure that the cases you use, have the already fired / indented primers still inside the pocket, because you will have to resort "reloading" them with primer compound harvested from the Hilti blanks. This is explained in the included ammunition guide by IvanTheTroll.

NOTE: Regarding the amount for loading 9mm cartridges with HILTI powder, don't follow the suggestion to use 3.5gr HILTI powder. The ammo guide is outdated in that regard.

For ideal operation of your FGC-9 you should use 9x19mm cartridges with either 147grain RN(round nose) bullets or 124grain RN bullets:

147 grain Round Nose



- Ideal for Suppressor use
- Full Metal Jacket or Plated
- Use 0.28 grams / 4.3grains of powder harvested from HILTI 6.8/11 RED nail gun blanks
- Load to Overall length (OAL) of the cartridge: 28.90mm +-0.05

124 grain Round Nose



- Better suited for long distance fire
- Full Metal Jacket or Plated
- Use 0.27 grams / 4.2grains of powder harvested from HILTI 6.8/11 RED nail gun blanks
- Load to OAL: 28.90mm +-0.05

For those who are able to buy reloading tools, here a recommended setup:



LEE Breech Lock Press 90045



LEE 4-DIE Carbide Set 9mm 90963



LEE Powder Measure 90058



LEE New Auto Prime 90230



LEE Shell Holder #19 90023



Scale with 0.01gram accuracy

Learn via Youtube tutorials extensively before starting. Watch this video as an introduction: <https://www.youtube.com/watch?v=hXh4GpmdJOg>

Visual overview of the components

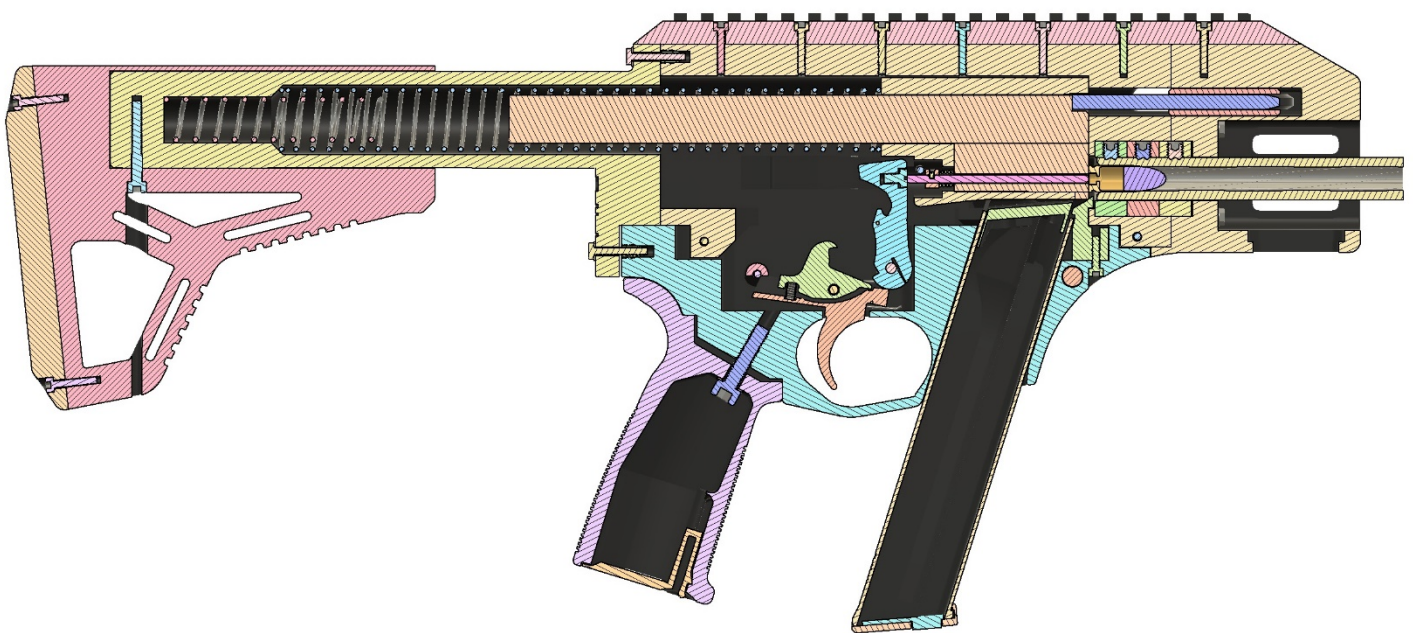
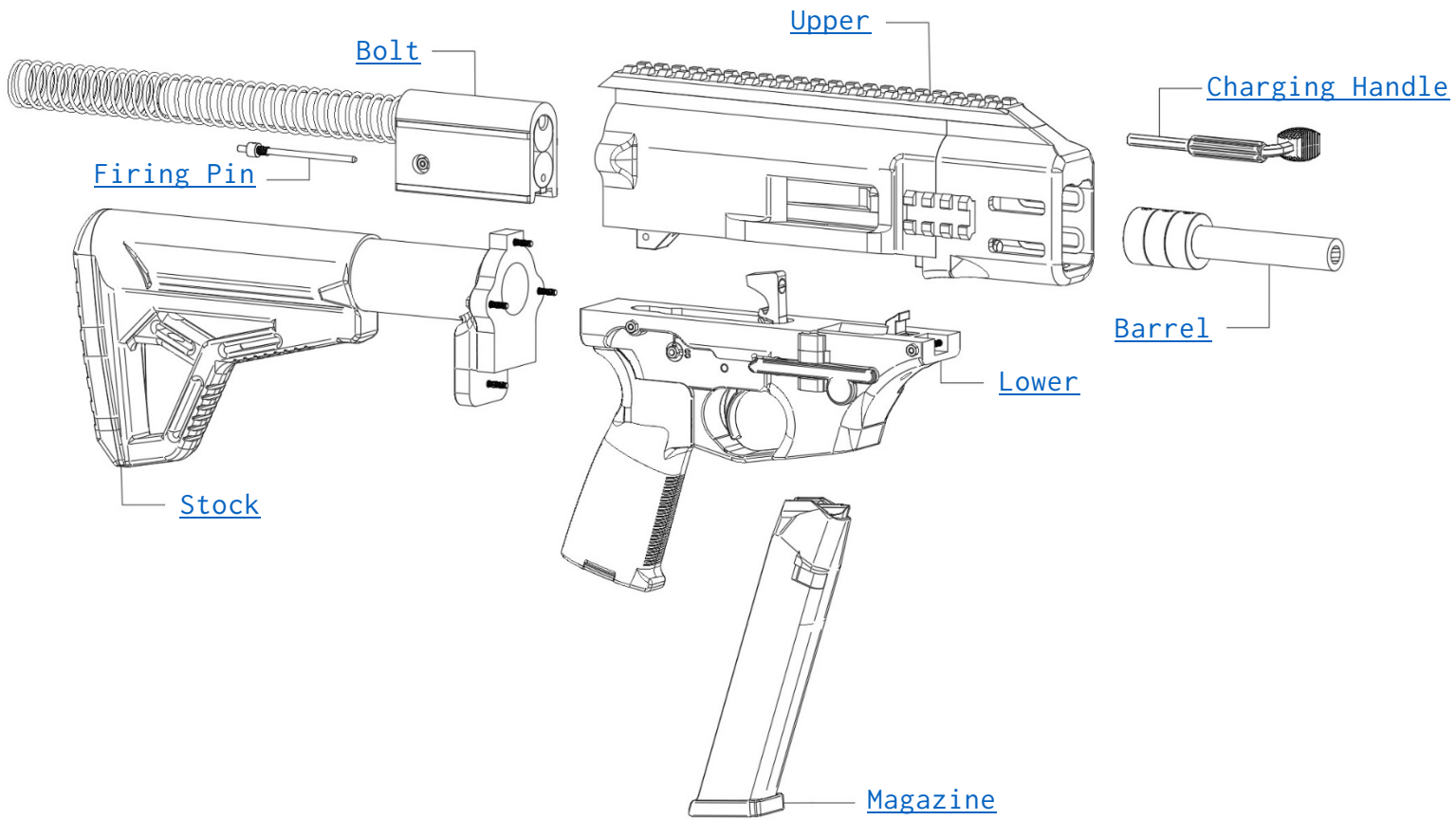

Making the barrel

You have three options to produce your FGC-9 barrel.

- Electro-Chemically Machining a hydraulic pipe

Buy a 16mm Outer Diameter, 8-8.6mm Inner Diameter Hydraulic Pipe / “Explosion-Proof-Pipe”, out of hardened steel and use “ECM” to bore, rifle and chamber it according to the included instructions. (USE THE INCLUDED ECM GUIDE)

Recommended option, All necessary information is included

*Don't be intimidated by this process.
This process is very easy to reproduce even as a lay person thanks to the help of the included instructions.
The tools that are necessary are cheap and available worldwide.*

- Using a simple steel pipe chambered with a drill bit

Buy a 16mm Outer Diameter, 9mm Inner Diameter steel pipe and cut it to at least 114mm length and then use a 10mm diameter drill bit that you cut flat beforehand, to ream the chamber to a depth of 15.95mm \pm 0.05. Make sure to add a radius to the entrance of the chamber.

- Machining a barrel out of a rifled barrel blank

Hire a gunsmith to do the following or do this yourself:

- Buy a rifled barrel blank for 9x19mm (In the US, for example on Brownells)
- Cut a 114mm+ section from the long piece
- Turn down the piece on the lathe to the OD of 16mm \pm 0.02
- Use a 9x19mm chamber reamer to ream the chamber to a depth of 15.95mm \pm 0.05
- Make sure to add a radius or a chamfer with rounded edges.
- (Optionally) Follow instructions on page 43 for muzzle thread

If you decide to machine a barrel from a rifled barrel blank yourself, you can buy the same tools shown on page 43 for this.

The only additional tools you will need is a 9x19mm chamber reamer with a square shank and a M5/M6 - M20 adjustable tap wrench.

The basics of the chamber reaming process are illustrated in this video: https://youtu.be/27Xz_oMZbbI?t=199

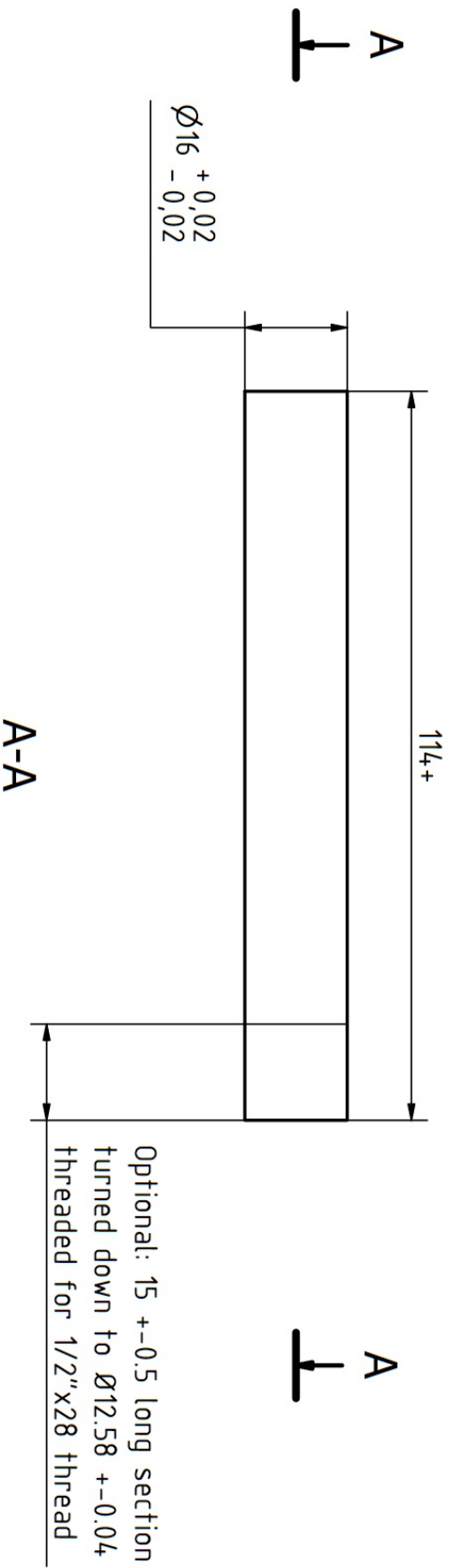

Optional: 15 ± 0.5 long section turned down to $\text{Ø}12.58 \pm 0.04$ threaded for 1/2"x28 thread

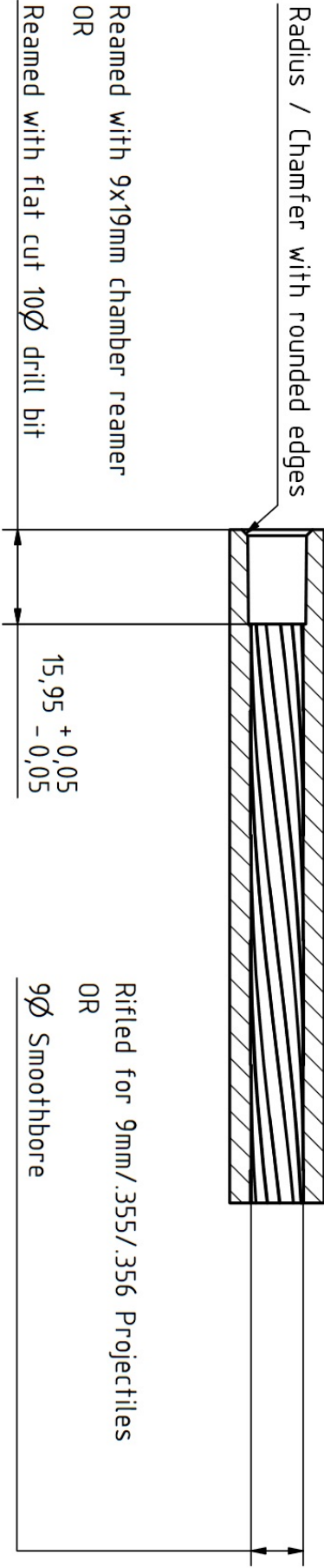

Reamed with 9x19mm chamber reamer
OR
Reamed with flat cut 10Ø drill bit

Rifled for 9mm/.355/.356 Projectiles
OR
9Ø Smoothbore

Materials: Steel		Author: JStark1809		Scale: 1:1		Unit: Millimeter			
Weaponized Autism Inc.		Document type: Component schematic		Status: Released		Signature: JStark1809		Sheet 1	
		Title: FGC-9 Barrel		Rev. Date: 1 08.05.2021					

Suppressor

For tactical purposes during the usage of the firearm and for being able to practice shooting and test fire in environments in which you need to be quiet, you might consider the use of a suppressor.

There are a multitude of suppressor options that can be freely bought and only need minor modification for use with your firearm.

The key issue that you will face with your FGC-9 is how to attach your suppressor to your barrel.

At the moment you have effectively two methods of attaching a suppressor to your FGC-9.

One will only require you to purchase an adapter that will let you attach the suppressor while the other option is more involved and will require access to a lathe.

Going with the more advanced option has the benefit of keeping the length of your suppressed setup as short as possible, as well as making sure that the suppressor is securely attached to your firearm.

A suppressed setup with the adapter will require caution during use, as the adapter and thus suppressor might get knocked off your barrel.

1. Adapter option:

Buy this exact 1/2x28" adapter that allows you to mount it to 16mm OD barrels: www.aliexpress.com/item/4000800532350.html (For 16mm Barrel)



16mm
with 1/2-28 Thread

- To make sure the adapter is properly secured to your barrel
YOU NEED TO BUY ADDITIONALLY:

2x Cup set screws M3 DIN916, 4mm

- The set screws that ship with the adapter are useless! Don't use them! Use the ordered M3 DIN 916 set screws instead!

- YOU WILL NEED TO DRILL THE INSIDE OF THE ADAPTER TO AN INNER DIAMETER OF 9mm with your 9mm drill bit !!!

DON'T FORGET THIS STEP!

2. Robust and more compact option:



- Buy a mini lathe such as the SIEG C2 or a 7" x 14" Mini Lathe
[Example Link](#)



- Buy a MT2 / MK2 live center tool
[Example Link](#)



- Buy a 8x8mm carbide tool holder and compatible carbide inserts (CCMT060204)
[Example Link](#)



- Buy a Thread Alignment Tool (TAT) for 1/2" x 28 thread for use with 9mm
[Example Link 1](#) [Example Link 2](#)

- Buy a 1/2" x 28 thread die that has an outer diameter of 1.5" / 38mm
[Example Link 1](#) [Example Link 2](#)

- Buy an adjustable die holder for use with 1.5" / 38mm OD dies
[Example Link 1](#) [Example Link 2](#)

NOTE: Do not install your shaft collars onto the barrel until you have completed the muzzle thread cutting process.



1/2"-28 For 9mm

Reducing the last 15mm section on your barrel to an OD of 12.58mm with the lathe:

1. Set up your lathe with the live center and one of your carbide tools.
2. Insert the chamber end of the barrel into the chuck and have the muzzle butt against the live center mounted in the tailstock of your lathe.
3. Turn the 15mm section near the muzzle to an outer diameter of 12.58mm ± 0.04 .
4. Take many light cuts, do not remove too much material at once and make sure you measure the OD after every few cuts to prevent reducing the OD too much.

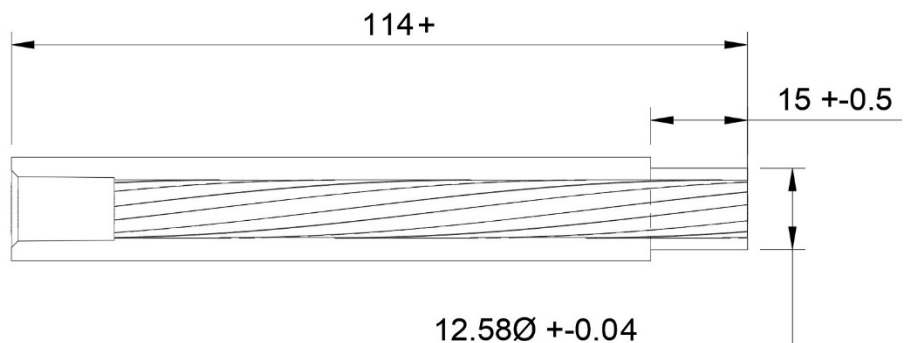

Cutting the muzzle thread with your threading die and TAT tool:



1. Screw the TAT about 4-5 threads into the back of the die with the pilot sticking out in front.



2. Insert die and TAT into handle, preferably lettered towards you and aligning at least one of the tightening screws in the handle with the divots in the die OD.



3. Secure the barrel vertically in a padded vise.

4. Apply a good cutting fluid/oil to the die teeth and start cutting.



It will take a little bit of vertical downward pressure to get started. Apply even downward pressure and rotate the die slowly.

5. Repeatedly advance the die about 1/8 turn, then back it off to break up the shaving (chips).

Do not allow the face of the TAT to ever reach the barrel face.

This could strip the teeth out, possibly damaging the TAT and ruining the few threads that you have cut on the barrel.

Even Downward Pressure

6. Once you have cut about 4-5 threads remove the TAT tool.



7. Resume threading as above, breaking the chips and applying cutting fluid as you go.

Suppressor selection:

There are two kinds of suppressors you have access to. One are the so called monocoresh suppressors and the kind that have multiple cups and a spacer inside, here referred to as cup suppressors.

The smaller the bore of a suppressor is the more effective at suppression it will be.

Monocoresh suppressors offer the advantage that you don't need to drill cups, but they have bores with diameters of around 12mm.

The suppressors that come with cups will require you to drill through the cups with a 10.5mm drill bit.

Thus these monocoresh suppressors are less effective at suppressing the sound of your shots than the cup suppressor options.

Note that any suppressor choice will need to have an outer diameter of at least 1.2 inch, as those that are slimmer in diameter tend to be not suited for the pressures created by the 9x19mm cartridge.

When it comes to length, the longer the suppressor is, the more effective at sound suppression it will be. A longer suppressor may become an issue though when handling your firearm inside buildings.

Ensure that you use subsonic 9x19mm ammo. If your projectiles are traveling faster than 1100fps/340 m/s, your shots will still be loud. You can use a [chronograph](#) to check the speed of your projectiles.

If you are loading your own ammo with HILTI powder with the amounts recommended on page 38, your bullets should travel at the appropriate speed of 1050fps. Only if you are adamant being absolutely sure your ammo is subsonic, while keeping the lethality as high as possible, would you need to doublecheck the speed of your bullets with a chronograph and then adjust the amount of powder for your ammo.

Cup Suppressor – 10 inch

MOST EFFECTIVE SUPPRESSOR OPTION

1/2"-28

OD:4.17"
ID:1.5"
Overall Length:10"



Current recommended source:

www.aliexpress.com/item/4000975392649.html
(Option: "1 2-28 Black")

NOTE: You will need to drill open all cups with a 10.5mm drill bit. Make sure that you drill perfectly through the center. If the endcaps have no hole of at least $\varnothing 10.5\text{mm}$, drill those as well.

How to stack the spacer and cups:

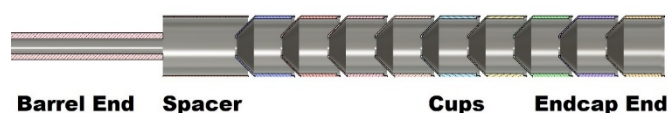

Note: Drill cups and endcap open with a 10.5mm Drill Bit

Cup Suppressor – 6 inch

1/2-28 Black



Current recommended source:

www.aliexpress.com/item/4001235575458.html
(Option: "1 2-28 black")

NOTE: You will need to drill open all cups with a 10.5mm drill bit. Make sure that you drill perfectly through the center. If the endcaps have no hole of at least $\varnothing 10.5\text{mm}$, drill those as well.

Monocore Suppressor – 10 inch

10 inch 1/2-28 Black



Current recommended sources:

www.aliexpress.com/item/1005001450369678.html

www.aliexpress.com/item/4001145063246.html

Less effective than cup suppressor options!

Recommended for cup suppressors: To increase the suppression effect of your suppressor cut out an appropriately size disc out of a 3mm sheet of "Polyurethan sheet PU90° Shore" and insert it into the endcap. Cut the disc just slightly larger than the inner diameter of the inside of the endcap to push it in to have it stay stuck inside. After the first shot, your bullet will create its own exit hole.

Make sure you don't use any hollow point bullets for the first few shots.

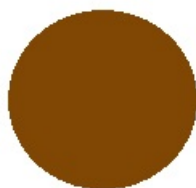

If you cut threads into your barrel with the "lathe+die" option, consider:



Muzzle thread protector (15mm length)

Example links:

www.aliexpress.com/item/4001360255712.html

www.aliexpress.com/item/32903441874.html (Choose:.223)

Making the charging handle

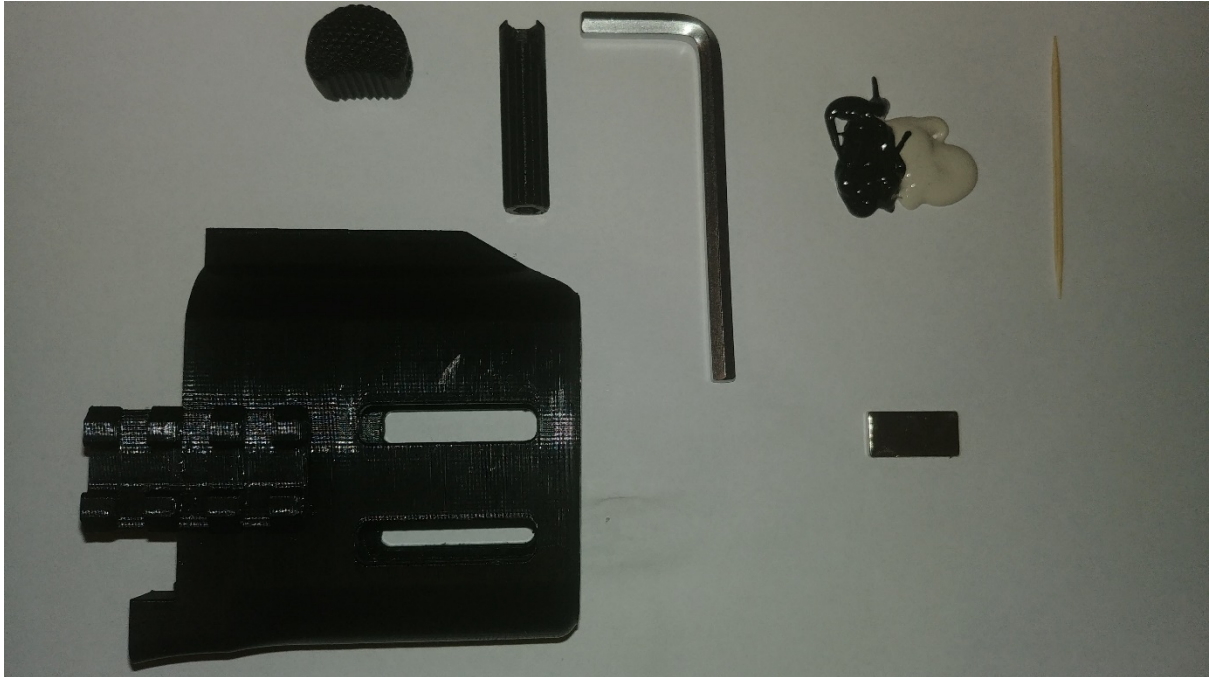

Gather the barrel retainer, charging handle, charging handle bushing, the 20x10x2mm magnet, 5mm Allen key and prepare the JB weld mixture.

Apply the JB weld mixture to the bend of the Allen Key.



Making sure the JB weld mixture is applied primarily in the area shown in the picture, shove the bushing over the Allen key and make sure that you push it AS FAR AS YOU CAN, before letting the charging handle dry.



Once you have the bushing pushed up on the bend of the Allen key you can then apply JB weld into the cavity of the charging handle knob and then push it over the shorter leg of the Allen key in the orientation shown in the picture.

Let the charging handle dry for at least 6 hours before further use.

Note: When using the charging handle you might at first chip away some material from the corner of the barrel retainer. This is normal.



While the charging handle is already drying, you can apply JB weld into the charging handle slot of the barrel retainer and then drop the magnet in. Make sure you clean the main surface of the magnet with a cotton swab or something similar to simply have that surface stay clean from any JB weld before letting it dry.

Making the firing pin

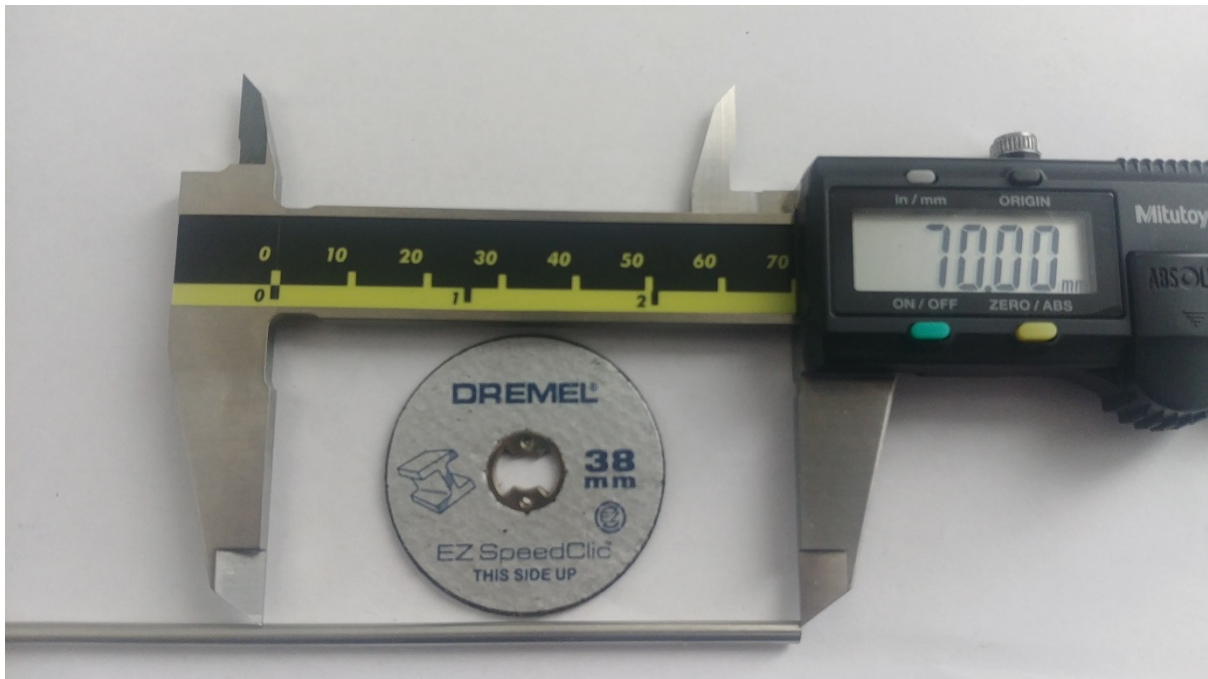

Cut off a 70mm long piece from your 3mm DIA steel bar with a Dremel tool /angle grinder with a steel cutting disc.

Make sure to remove any nasty edges by using sand paper or your metal file before inserting it into the power drill in the next step.

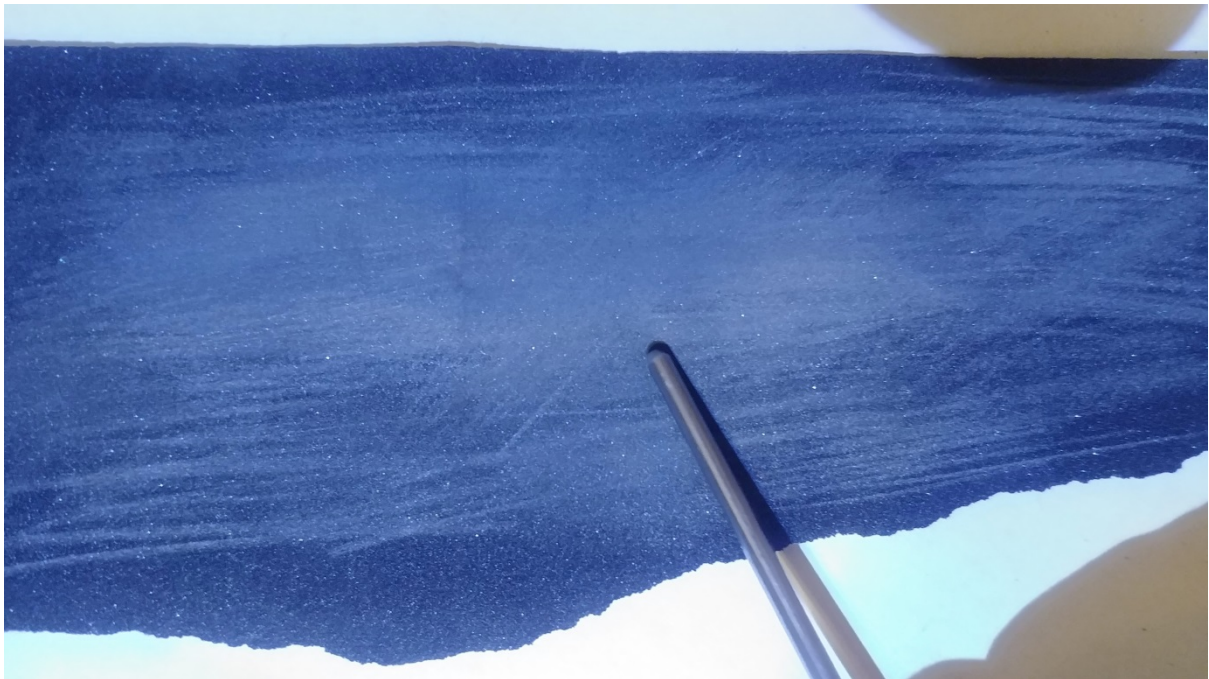
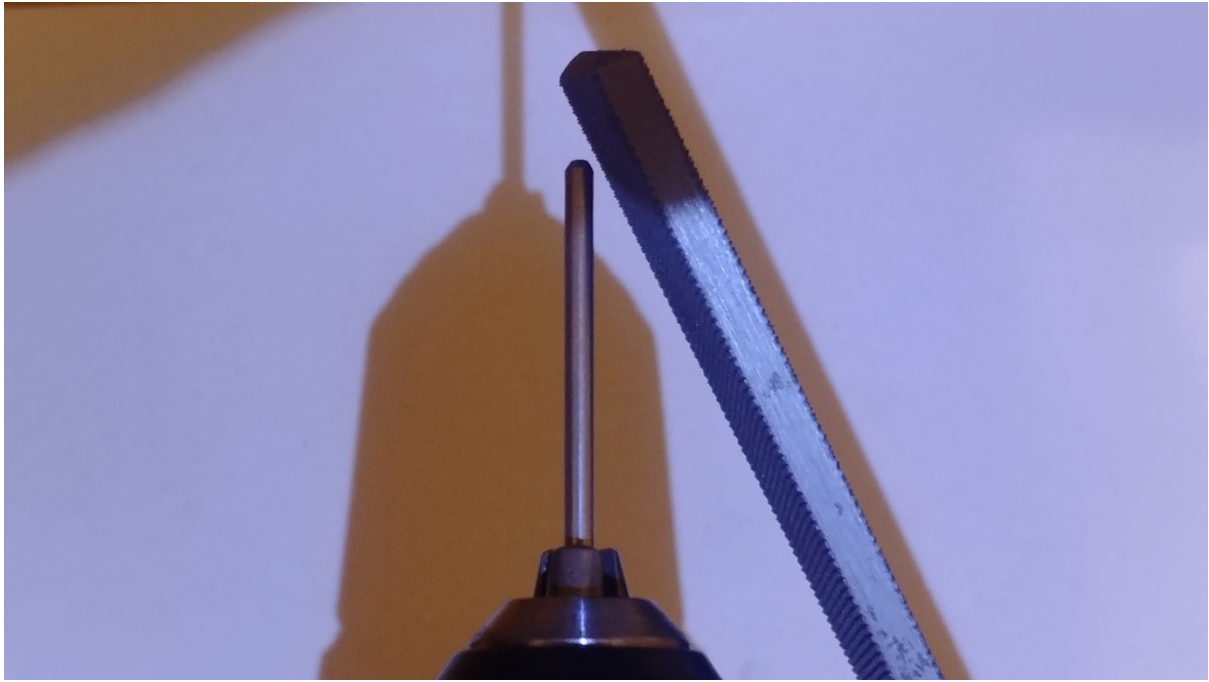

Put the bar into a power drill and rotate it while holding a metal file against it to form a chamfered circular end at the tip that is about 1.5mm in diameter.

Then use sandpaper to finish the shape of the tip so that it looks like in the picture.

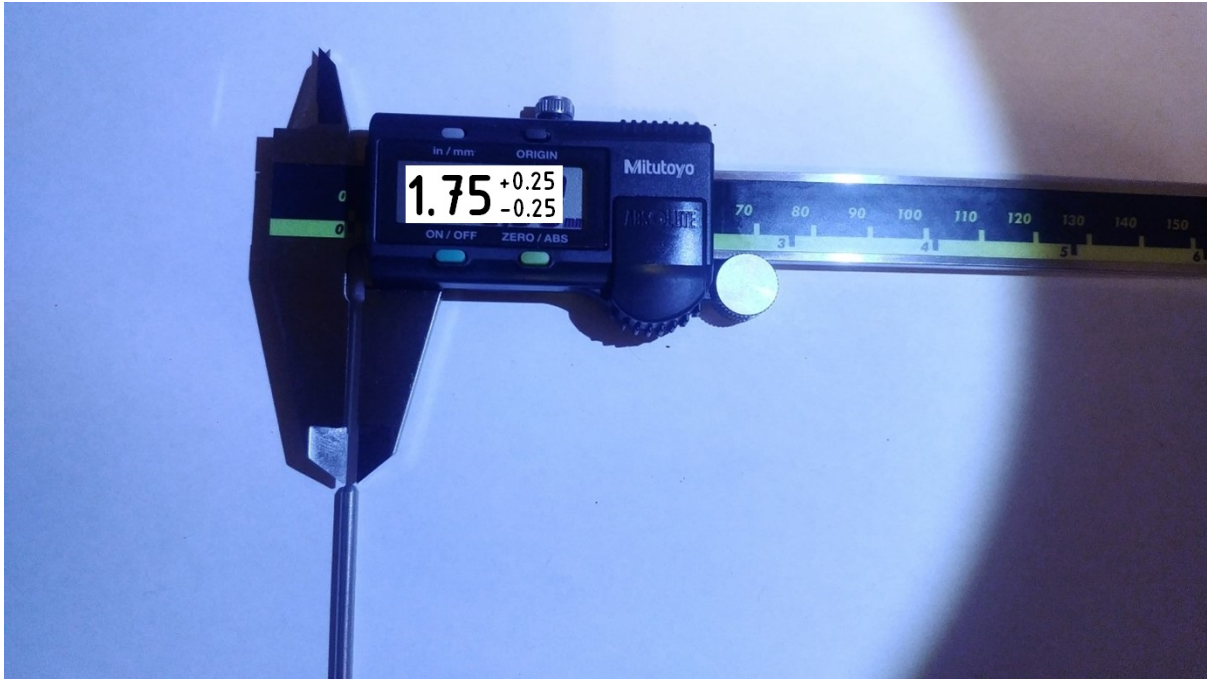

Measure the diameter of the face of the tip.

Grind the firing pin tip against sand paper to reach a diameter of around 1.75mm.
You can deviate by about 0.25mm.

Anywhere between 1.50mm-2.00mm is fine.

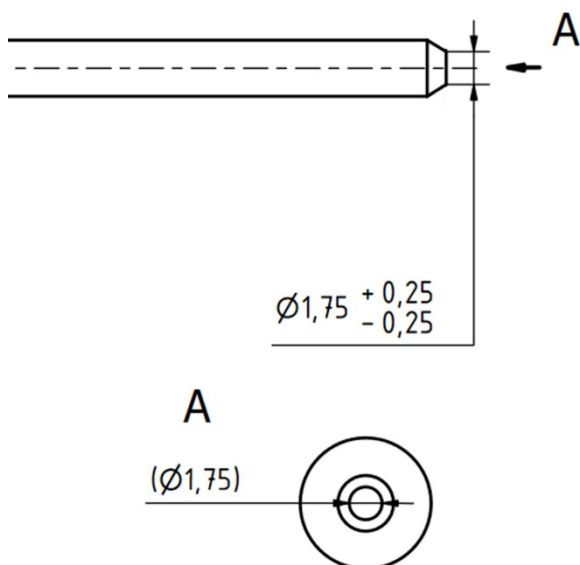



Use your caliper blades to scratch a line around the circumference of the bar at a distance of 58.35mm from the tip.

At that exact distance you will have to drill a divot into the pin later on so make sure you have that spot marked by having a clearly visible belt at the distance of 58.35mm from the tip.

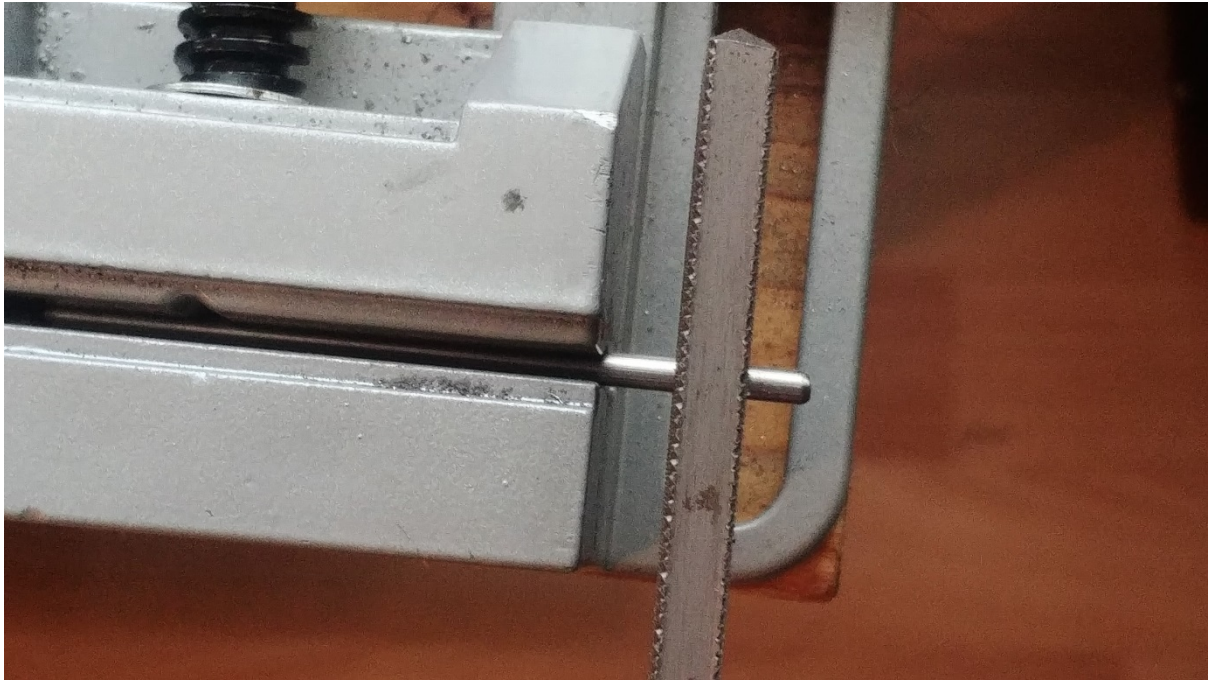

Put the bar into a vise and use the edge of your metal file to create a flat section around the previously marked position.

Only file so much that you have a flat area to drill into for the divot later on.



Use your power drill and a 1mm drill bit and then afterwards go deeper with a 2mm drill bit, to create a divot deep in the bar that is in the center of the flat area you created, that is aligned with the previously created line which is 58.35mm from the tip.

Instead of the 1mm drill bit you can also use a punch and a hammer to mark the spot before using the 2mm drill bit.

Note: The divot is not center in the picture. You should do a better job than that ;)

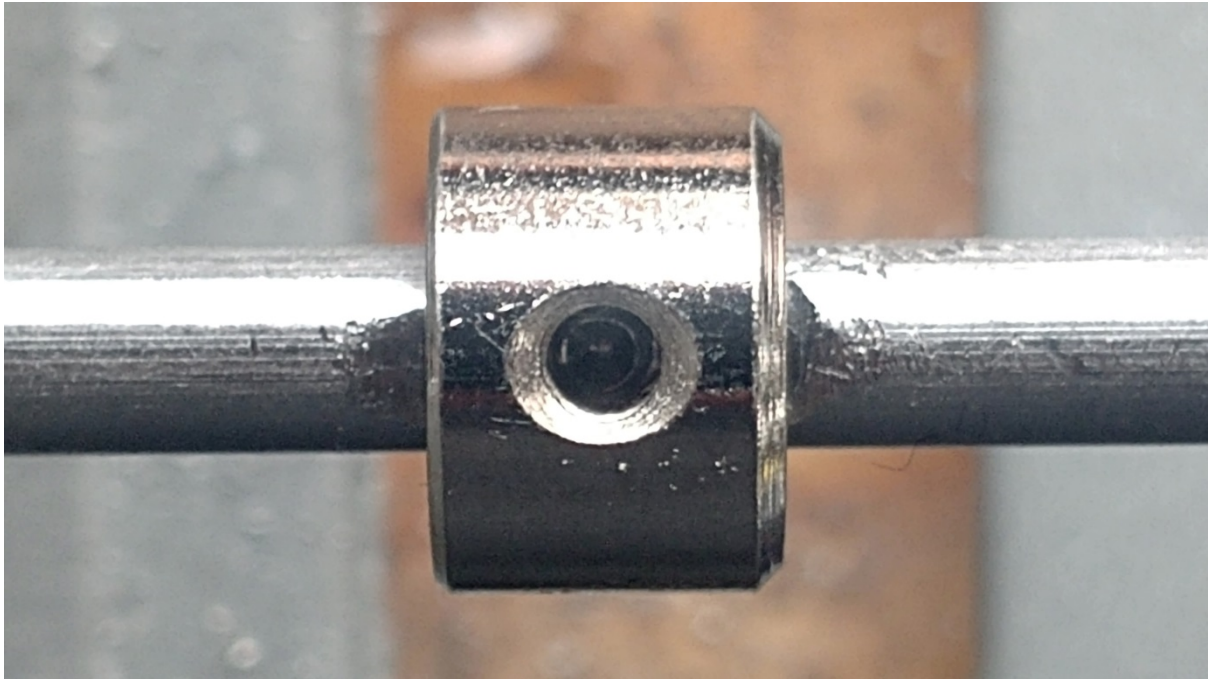

Remove the grub screw from the shaft collar and put the shaft collar onto the bar aligning the hole of it with the divot to get an idea where the shaft collar should be for the later steps.



Mix up some JB weld with a tooth pick.

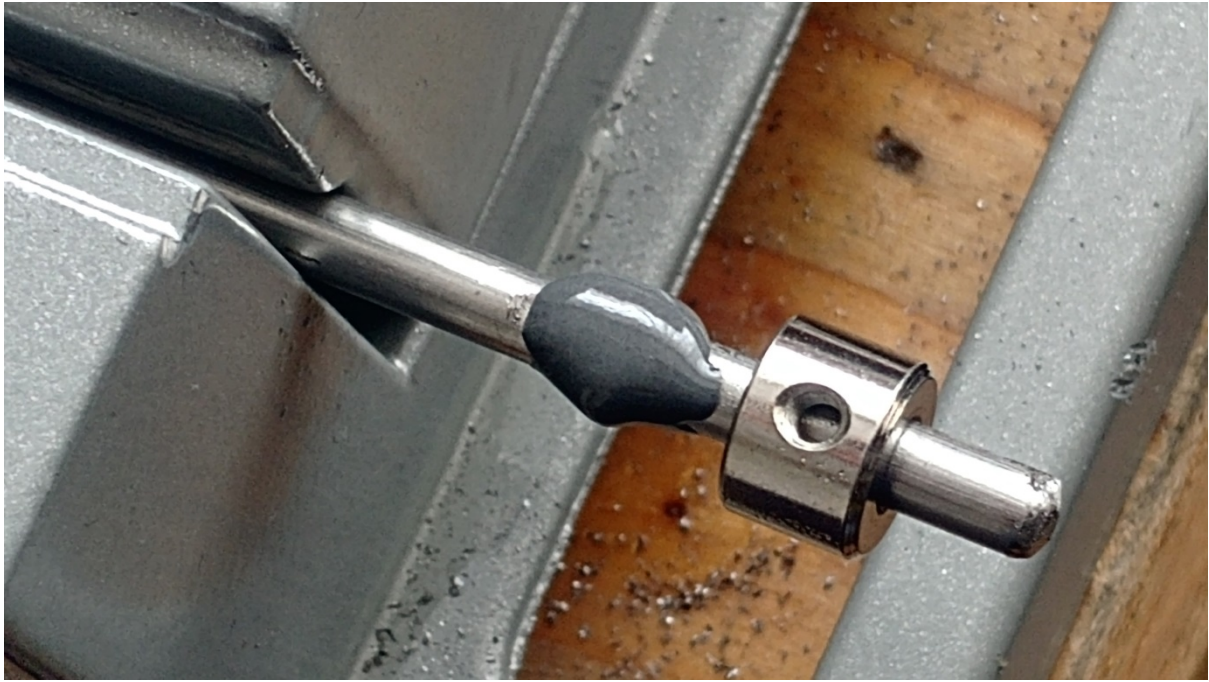

Remove the shaft collar and put some JB Weld onto the flat area that you filed and fill up the drilled divot. Then slide the shaft collar to that position and try to line up the hole with a tooth pick through the hole of the shaft collar. Try to remove the JB weld out of the shaft collar screw hole so you can see that the shaft collar hole is centered with the divot.



Once you have made sure the shaft collar screw hole is lined up with the divot you previously created by probing with a toothpick, you can fill the hole with JB weld. Be careful not to move the shaft collar away from its position at this point.



Take a razor blade or the appropriate hex key depending on your type of 3mm shaft collar and screw the grub screw into the JB Weld-filled shaft collar screw hole.

You can apply a tiny droplet of grease to the end of your tool/razor blade, to have the set screw stick to the tool, if you have trouble screwing the set screw in.

After the set screw is completely screwed in, cover the entire shaft collar and the area behind the shaft collar with JB Weld.

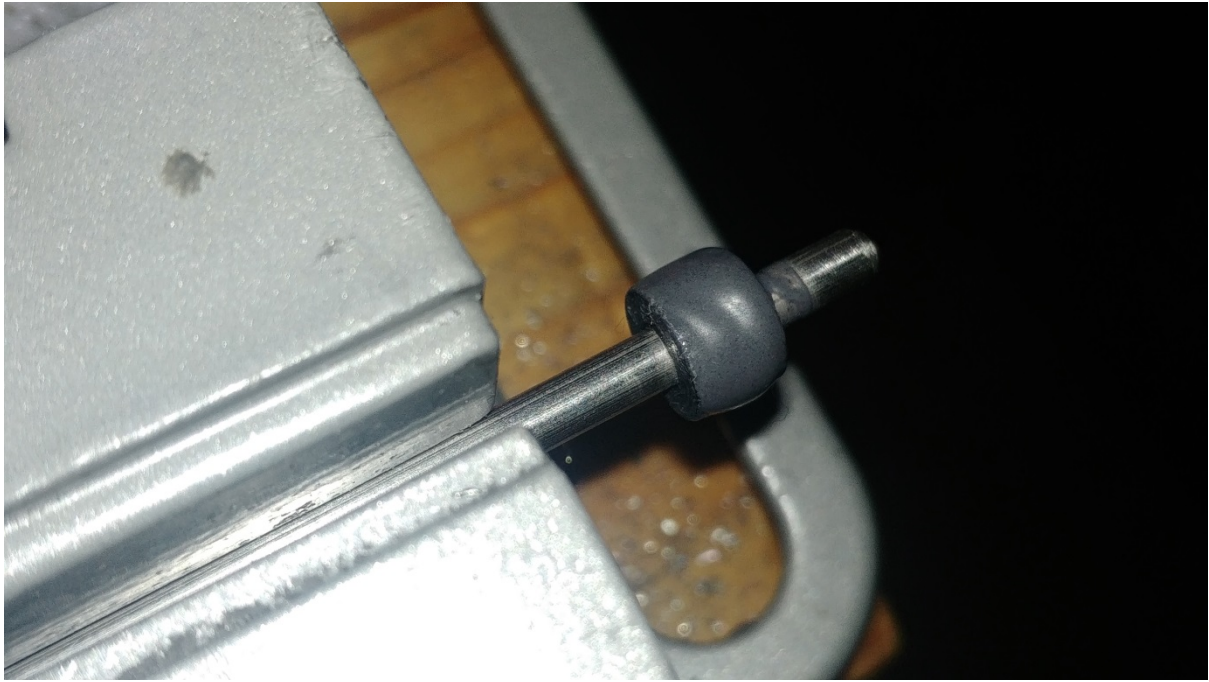

Clean the flat side of the shaft collar that is towards the tip from any JB weld.

Be sure to have only a minimal amount of JB weld on the backside of the shaft collar.

After you have applied JB weld and cleaned it from the places that should be free of JB weld, as you can see in the picture, let the firing pin cure in a vertical position for at least 24 hours.

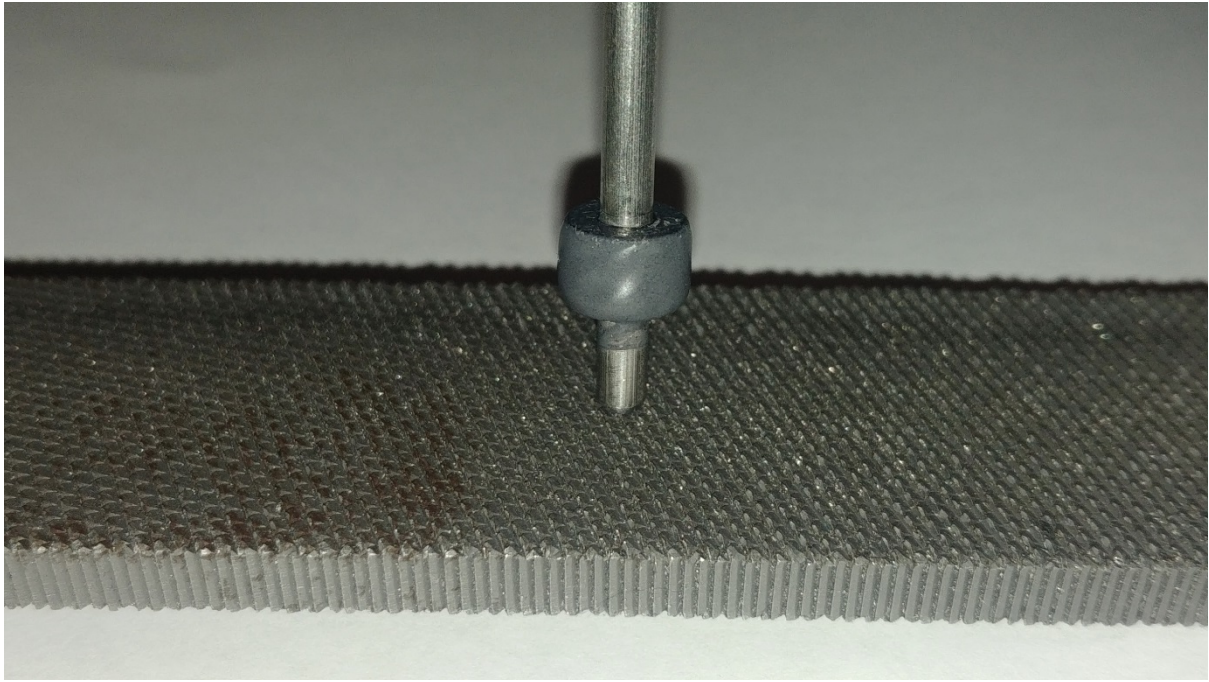

Use a metal file to shorten the firing pin by grinding the back end of the firing pin and reach an overall length of 67.50mm.

Make sure to do this carefully and measure often during the process.

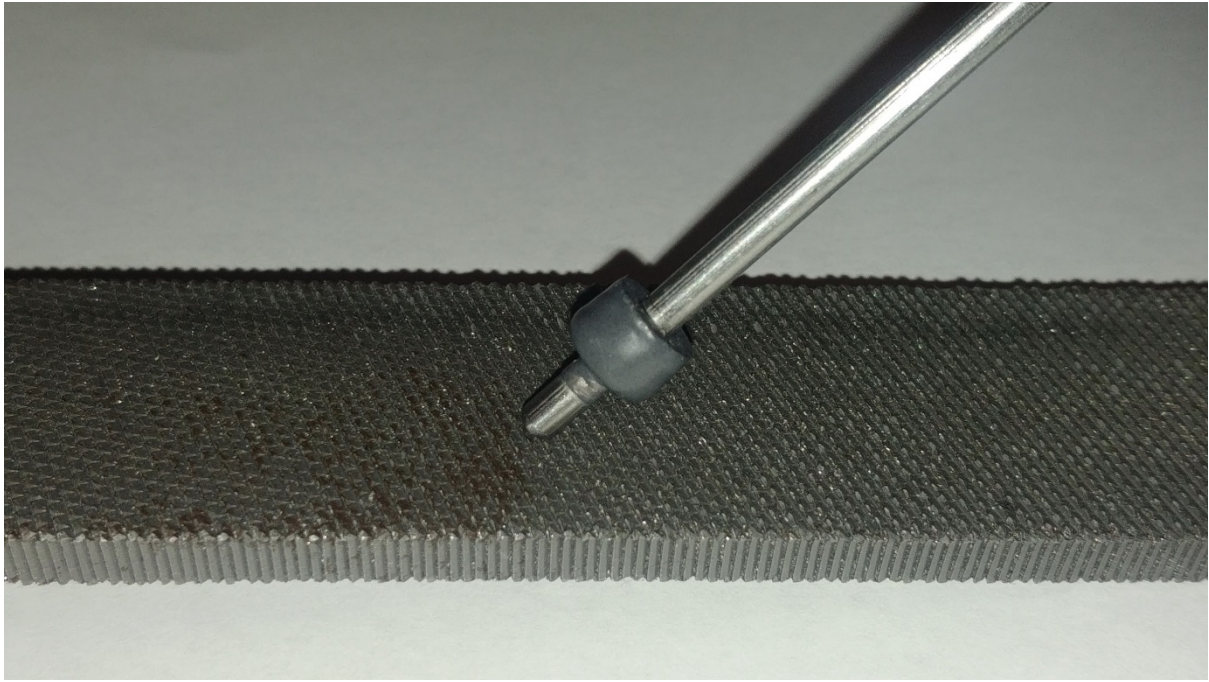

After you reach the final length, round off the edges at the end of the back a little, as you see in the picture.

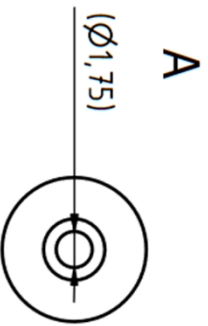
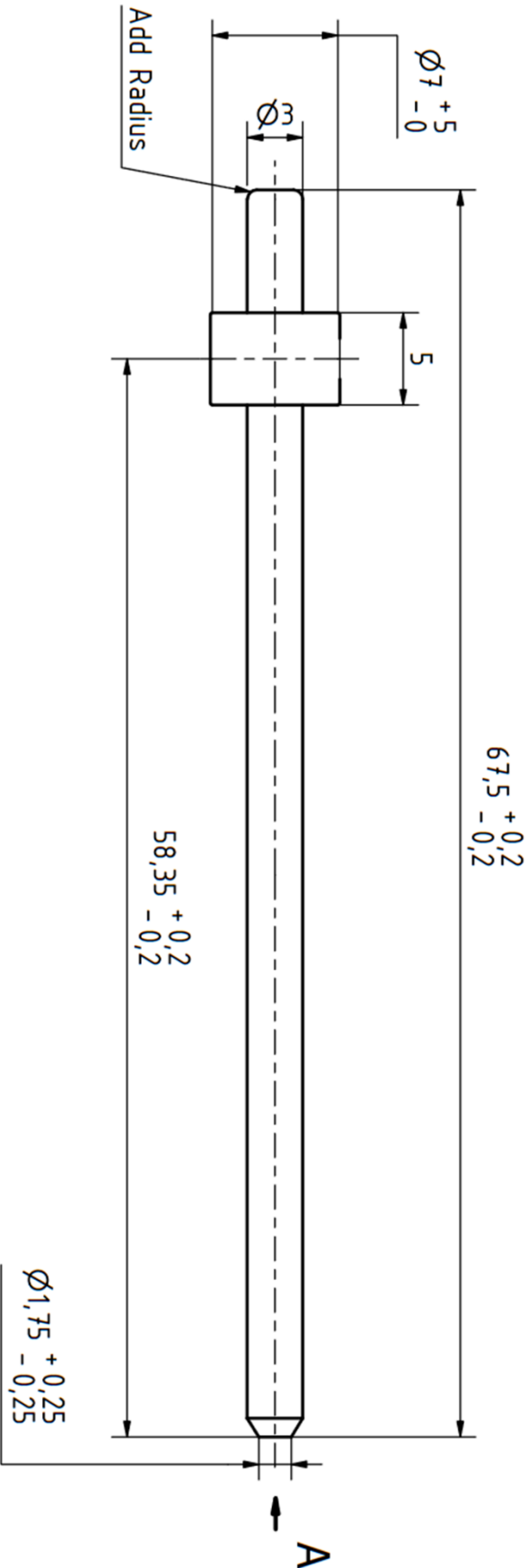

Material: Steel	Author: JSfark1809	Scale: 1:1	Unit: Millimeter	
Weaponized Autism Inc.	Document type: Component schematic	Status: Released		
	Title: FGC-9 Firing Pin	Signature: JSfark1809		
	Rev. Date: 08.05.2021	Rev. Date: 08.05.2021	Sheet 1	

Melting in the thread inserts

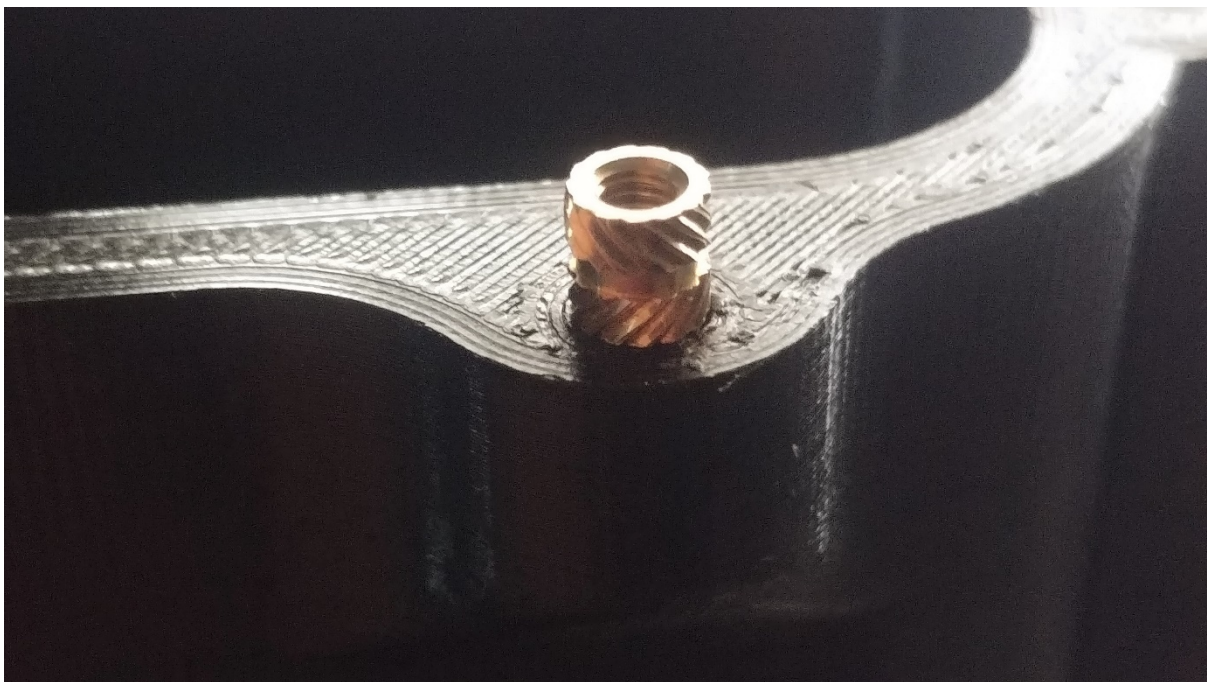

Prepare all four thread inserts as well as the upper receiver and lower receiver. Get your soldering iron and pre-heat it to at least 220°C. Put the thread inserts with the tapered side into the holes on the back side of the upper and lower receiver.

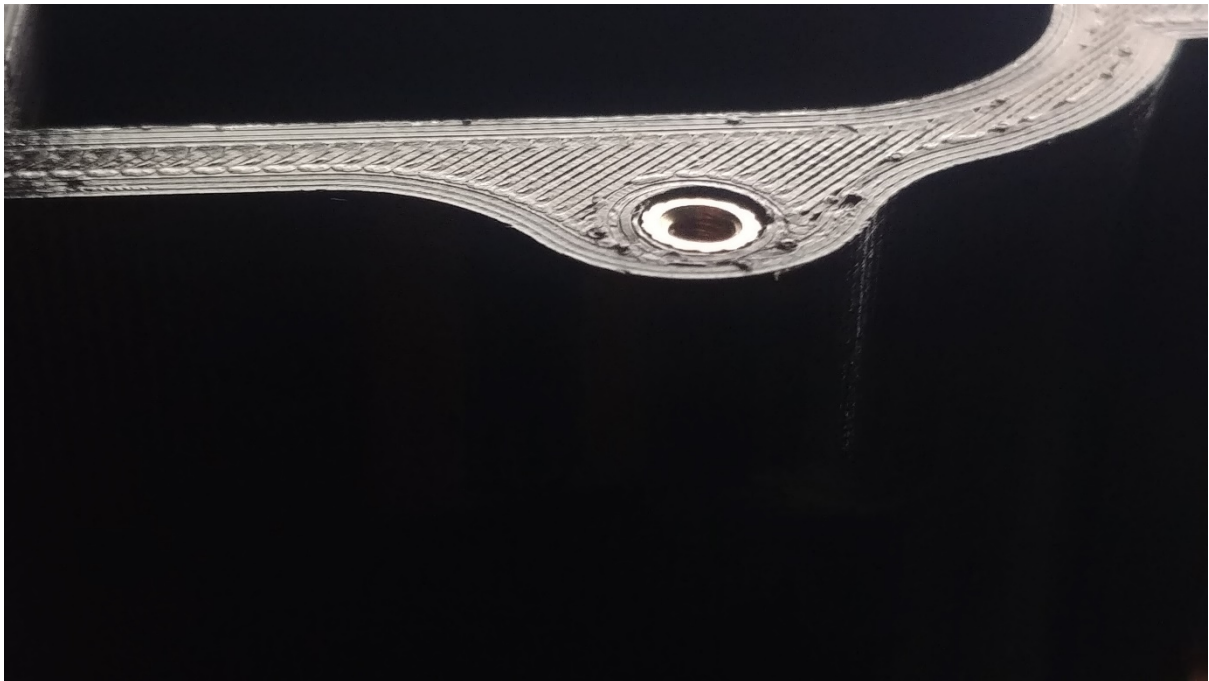

Making sure the inserts can go down in straight, use your soldering iron to push in the thread inserts about 1-2mm past the entrance of the hole. The inserts should not stick out of the hole. Sand around the edge with sandpaper if material sticks out.

Making the bolt

The bolt of the FGC-9 will be the most complex part to produce and will be at the heart of the firing mechanism.

You will have two main ways of attaching the steel stock pieces together that make up the steel portion of the bolt.

Either using a stick welder to attach the two pieces or using JB weld and a piece of square steel stock.

Along with these differences, how the round pickup is added will differ. The rest of the process to build the bolt will be the same. You can choose one or the other depending on your budget and other limitations that have to do with the nature of welding. If you have the tools / environment to go with the option to weld the two steel pieces together and make your bolt that way, it is recommended you do that.

A bolt made with welding will result in a more robust construction that you can have complete confidence in and you will need less manual labor to finish it.

For both paths you will need to begin with drilling the firing pin channel and end with the same recess drilling process. Be sure to read the following pages before starting either process, to get an idea how the options differ.

Welded FGC-9 MkII Bolt Assembly

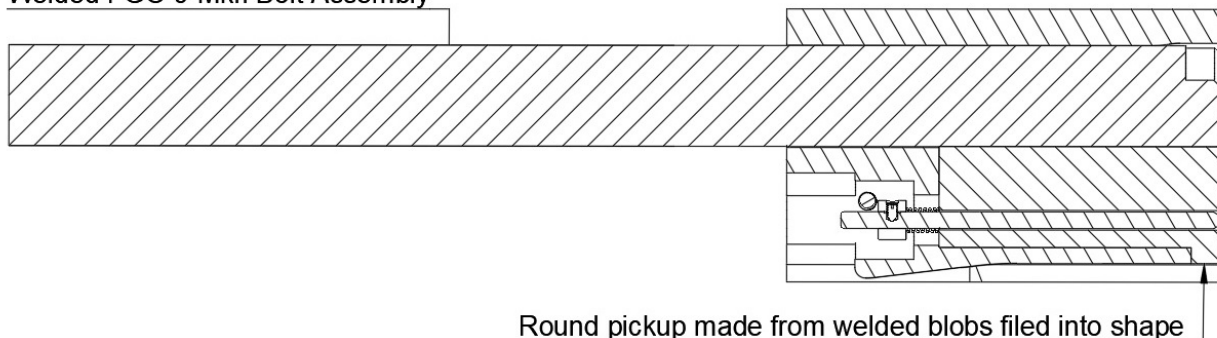

Weldless FGC-9 MkII Bolt Assembly

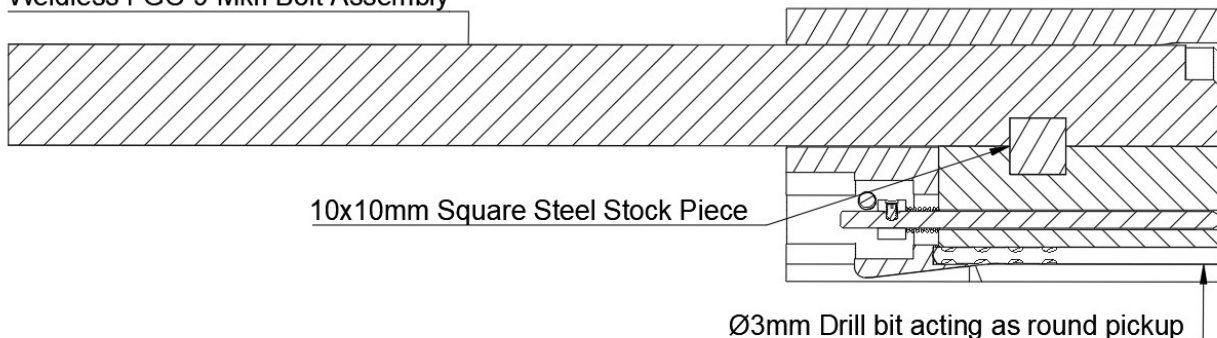

Drilling the lower bolt rod

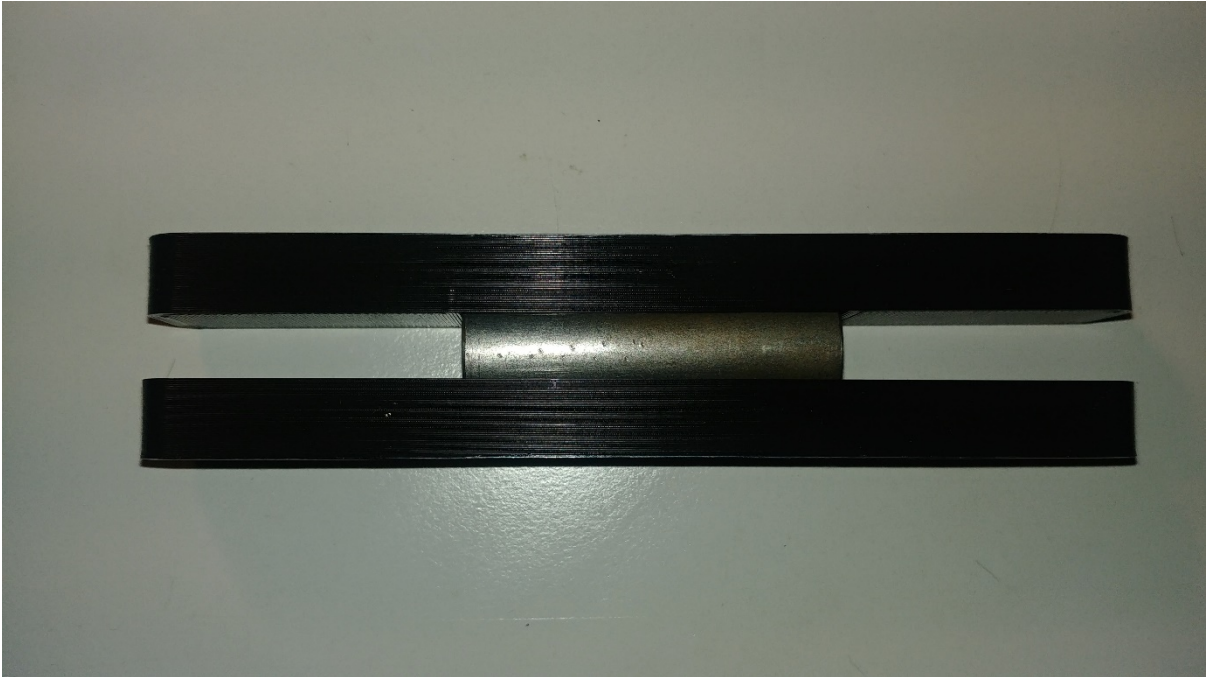

Get your power drill ready with the long 3.5mm diameter drill bit, as well as both drilling jig halves and the 50mm long 18mm bar. Put the short bolt piece (18mm diameter, 50mm long) in between the drilling jig halves.

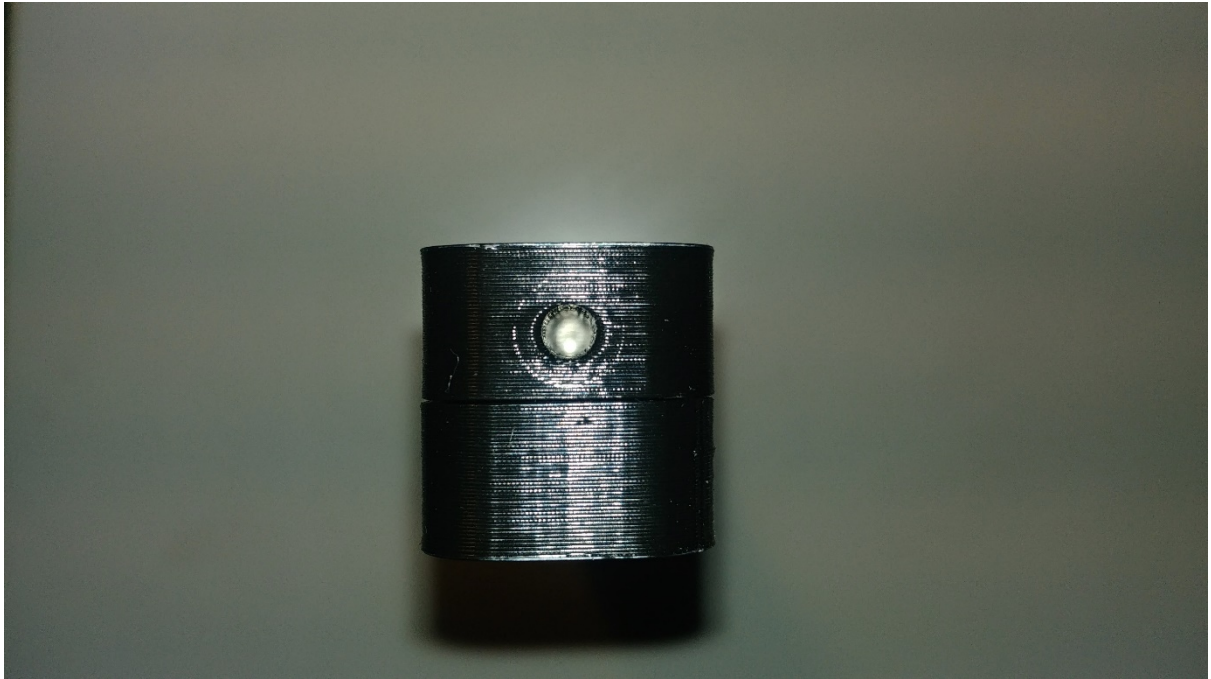

Put the drilling jig with the bolt piece inside, in between the jaws of your table-mounted vise.

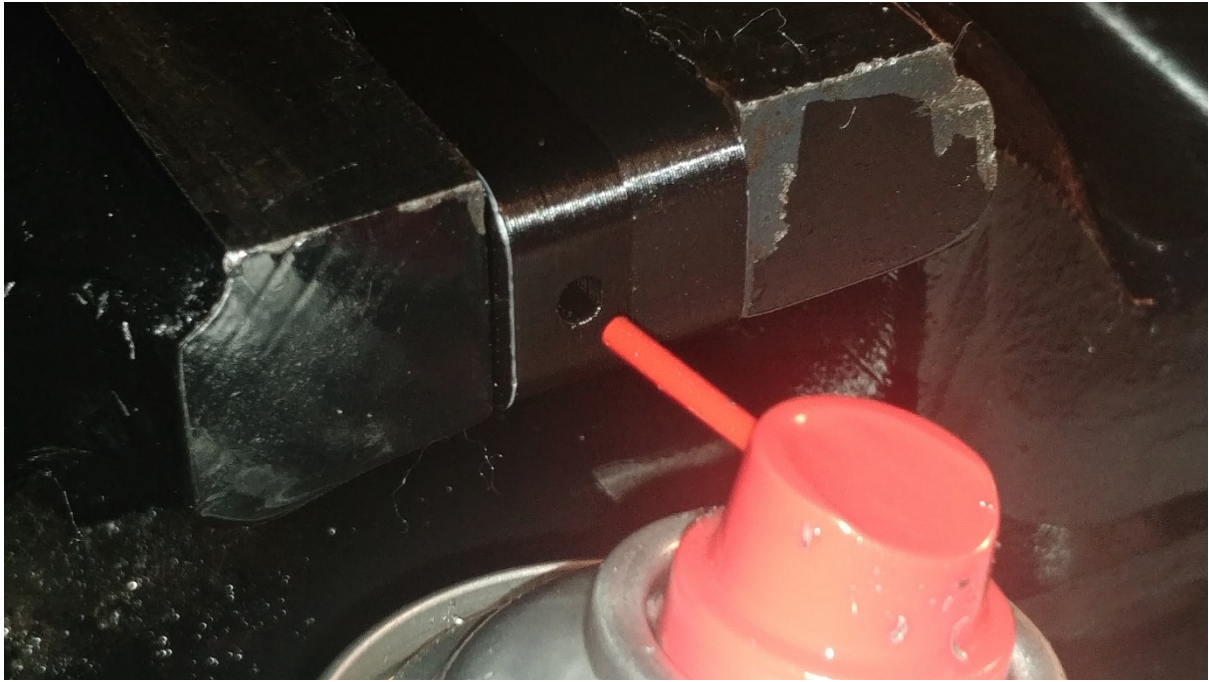

Spray cutting fluid into the hole before starting to drill. With ample of forward pressure start drilling into the setup.

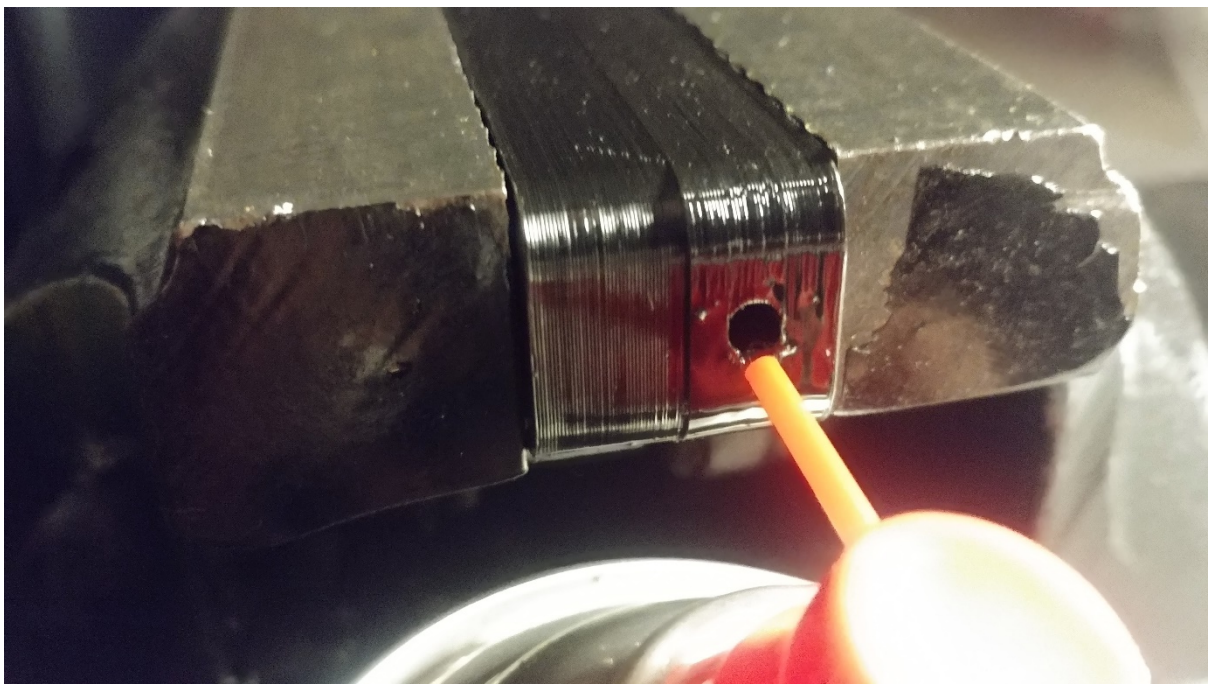
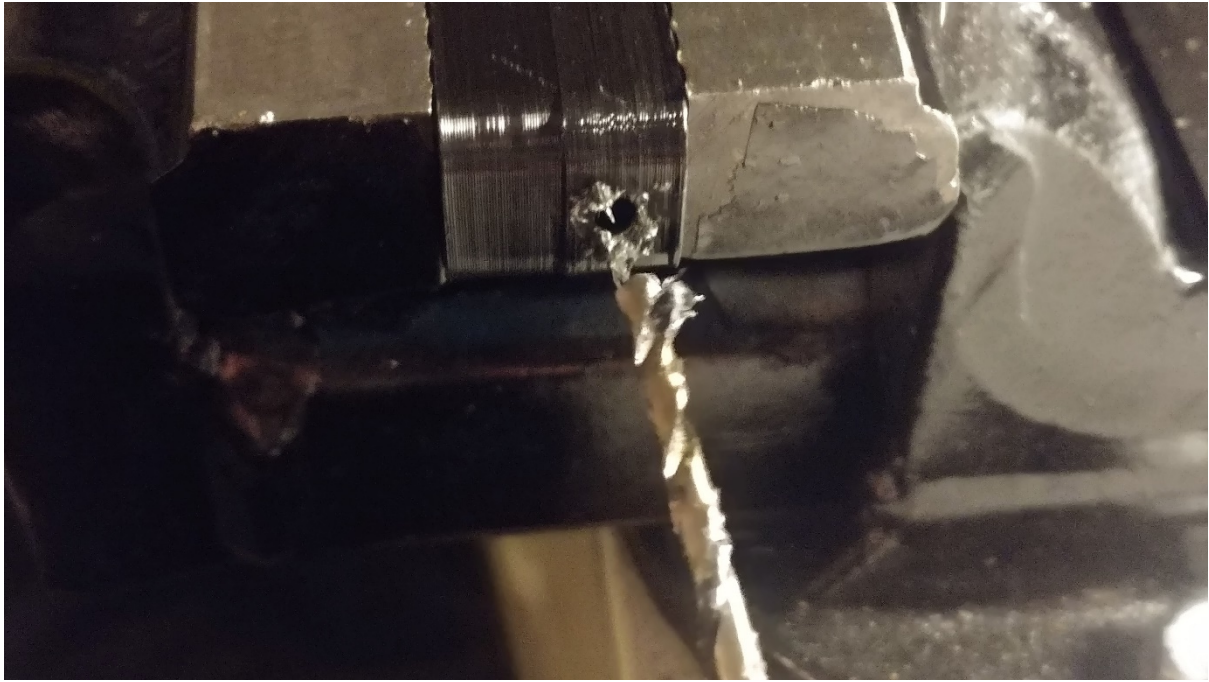

Drill a few millimeters into the hole and then remove the steel chips and add new cutting fluid, then drill again. Repeat this until you can feel that you got through the entire bolt piece.



Request for feedback / Help improve the drilling jig:

If you properly followed the instructions using this jig and later on found out that the firing pin indentations are not center but somewhat off-center, note the deviation, by using empty cases and remember in what orientation you inserted the case into the chamber. Then let the firing pin hit the empty case / already struck primer and note whether the off-center indentation is towards the 12 o'clock or more towards the 6 o'clock relative to the center. Measure how far off your indentations are in millimeter and note the relative o'clock position. Send me your findings via E-Mail: JStark1809@protonmail.com

Welded Bolt Option



Prepare the tools and materials that you need for the welding process:

- 1x 50mm long, 18mm diameter steel rod piece
- 1x 216mm long, 18mm diameter steel rod piece
- Digital Caliper
- Welding table or sheet metal to weld on
- Welding helmet, gloves and welding skirt
- Welding device powered up and connected
- Welding clamp(s)
- Welding Jig

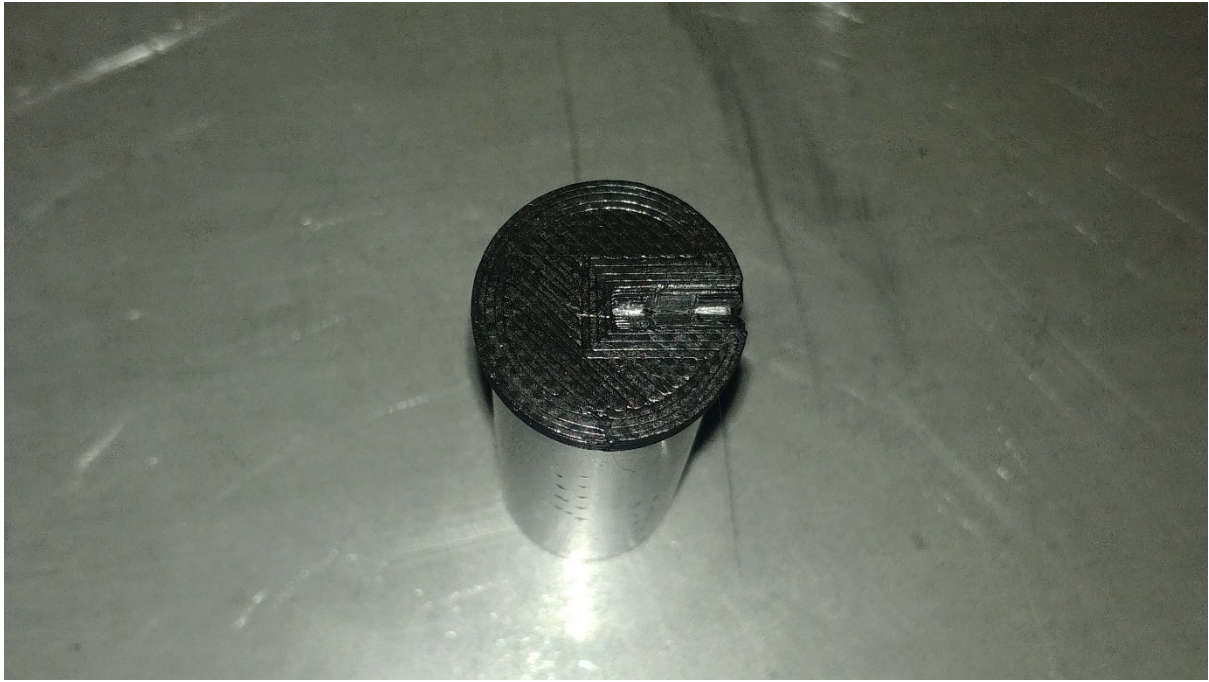

Put the welding jig onto the end of your 50mm bolt piece aligning it via the firing pin channel hole. Use the bottom corner of your digital caliper or a similar metal device to scratch along the slot of the welding jig.

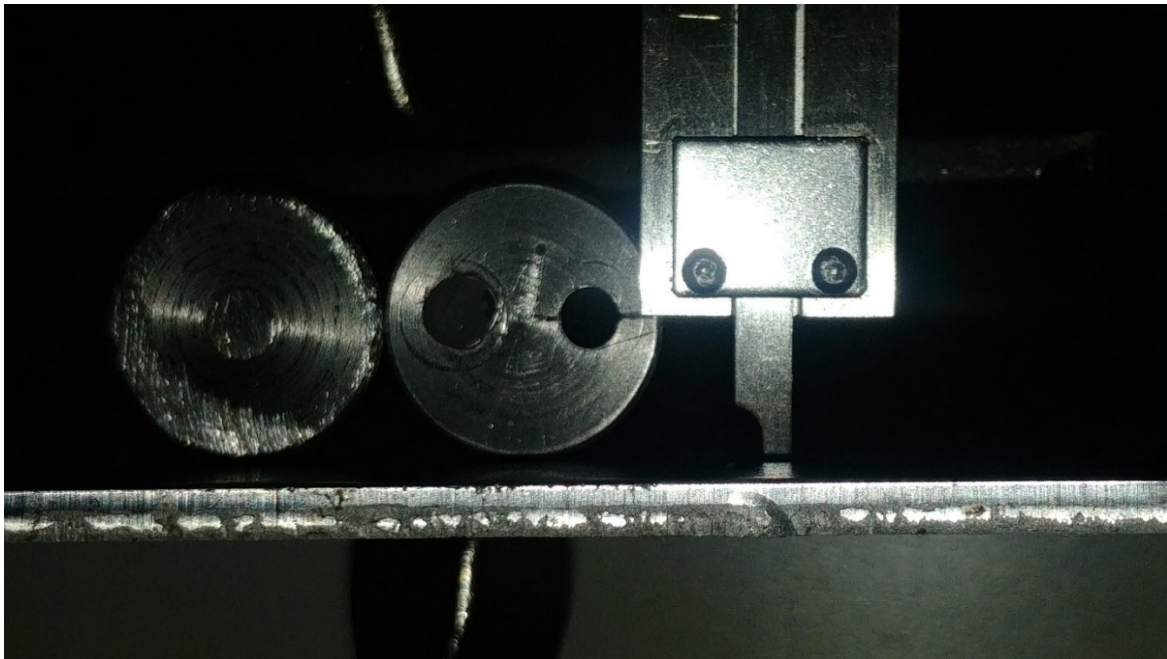
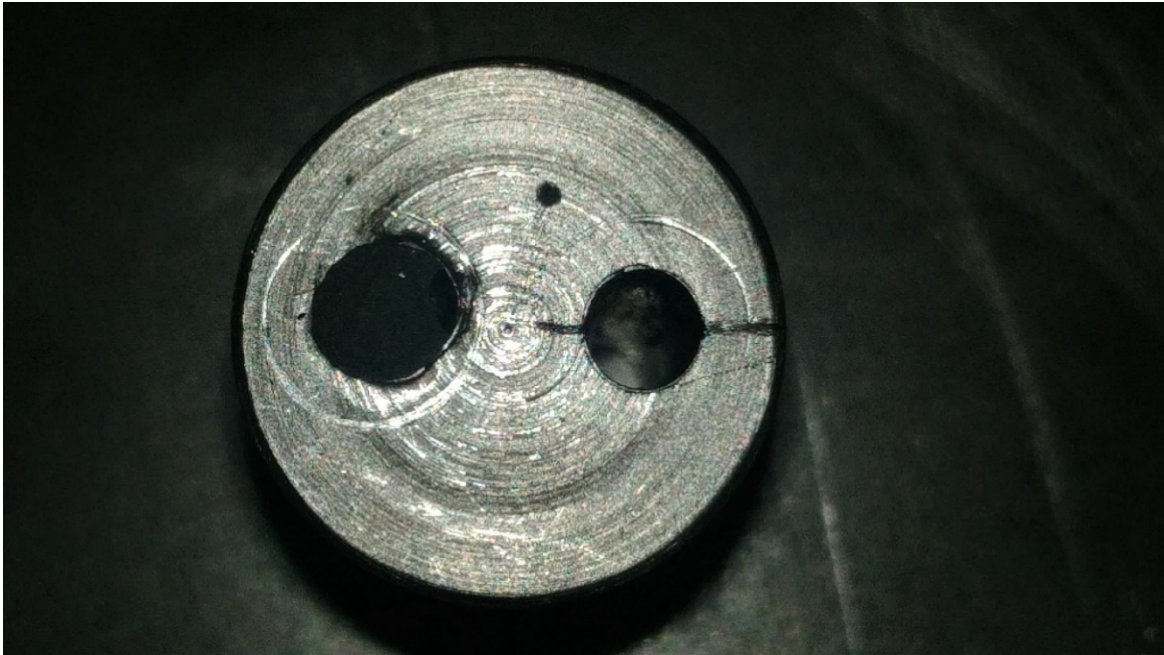

You should now have a clearly visible line on the side of the lower bolt piece that you want to be the bolt face of your bolt.

Now put the 50mm long bolt piece as well as the 216mm long bolt piece and put them next to each other as close and straight as possible.

The firing pin channel should be at the 3 o'clock position, while the longer bolt piece should be laid at the 9 o'clock side of the shorter bolt piece. Just look at the image to see how it should look like.

Use the depth rod of your digital caliper to align the firing pin hole to be perfectly at the 3 o'clock position as you see it in this picture. You do this by measuring the distance of the line to the bottom of the plate you have the bolt piece on. Since the bolt piece has a diameter of 18mm, you need the distance of the scratched line to the bottom to be exactly 9mm.

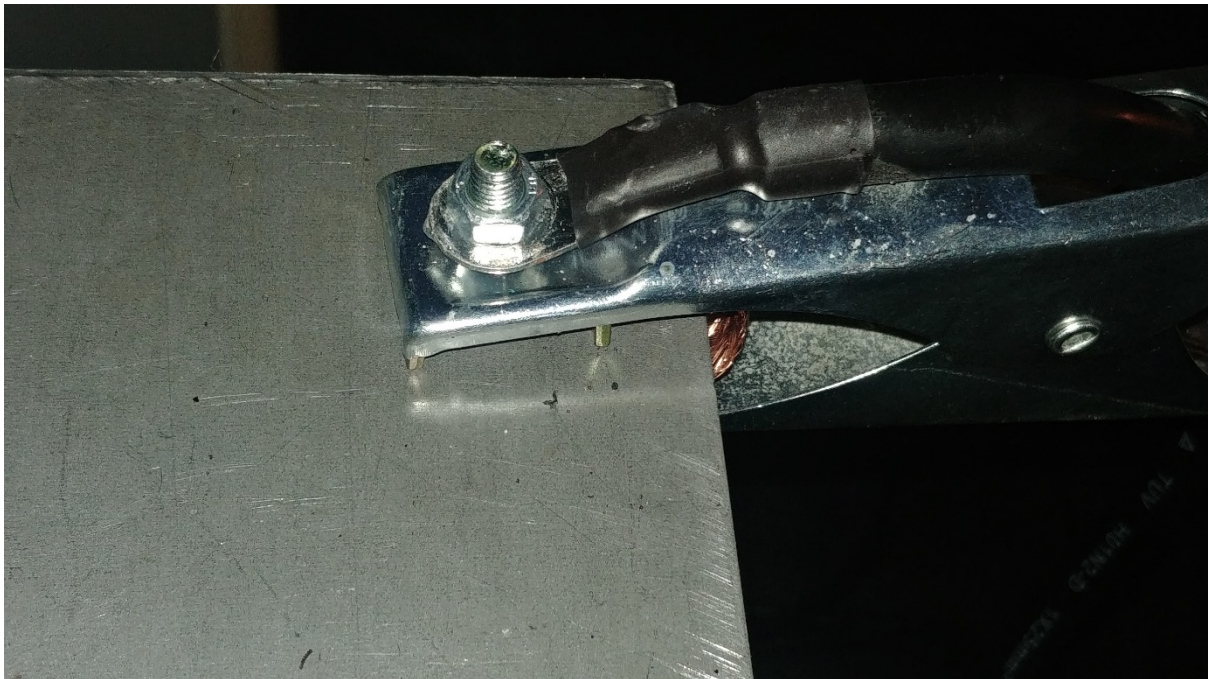
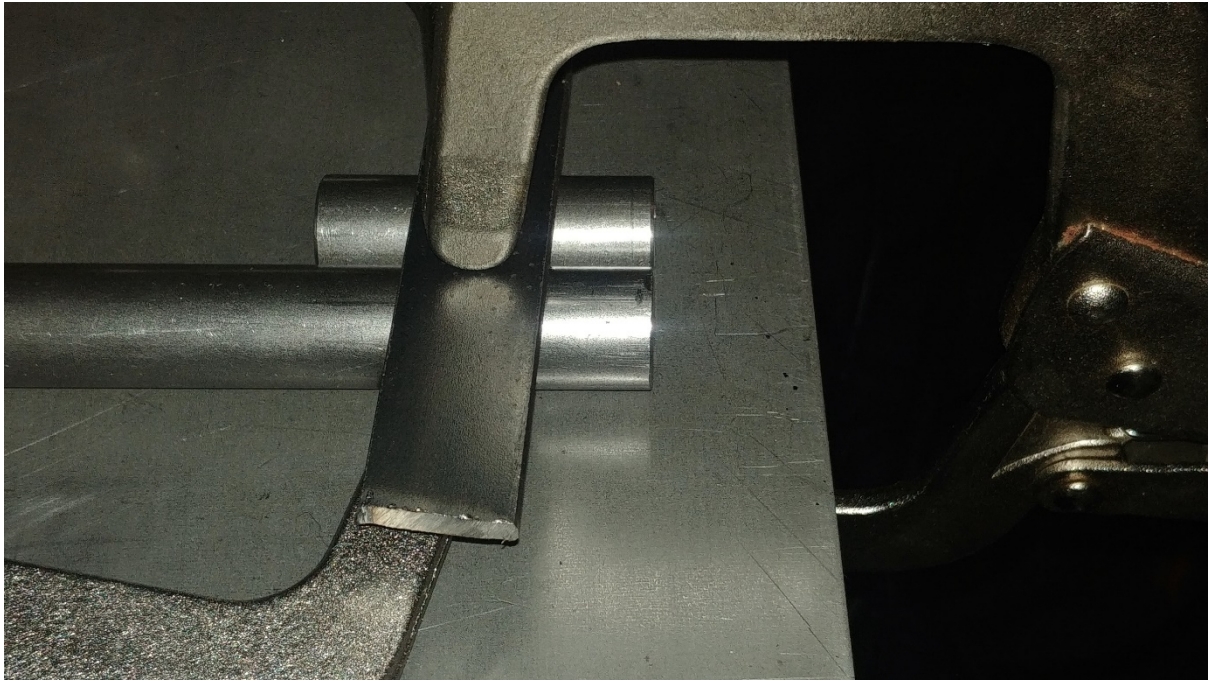

After you have made sure that the drilled hole in the shorter bolt piece is exactly halfway between top and bottom (at the 3 o'clock position) use your welding clamp to fix the two bolt piece perfectly into position as you can see it in the upper picture.

Measure the 9mm distance again to confirm that the firing pin hole is still perfectly at the 3 o'clock position. Make absolutely sure that the front faces/ends of the bolt pieces are absolutely flush. (LOOK AT THE UPPER PICTURE). Meaning on the front/bolt face the ends should be in line and one bolt should not stick out more than the other.

You can now go ahead and connect the contact of your welder to the welder table and turn on your welding device.



Turn on your arc welder and then set the appropriate amperage which you can find on the packaging of the electrode you will be using, for example when using some 2.5mm diameter electrodes you will need to set your arc welder between 65 and 80 amps.

Be sure to wear welding gloves, welding apron and a welding visor before going ahead.

Attach the negative contact from the arc welder to the metal plate on which the bolt pieces are laying.

Hold one of your electrodes with your electrode holder which is plugged into the arc welder device and use some scrap sheet metal strip to try to start a bead, meaning you will have to get the feel to start welding. Imagine what it feels like to strike a match. In a similar fashion you need to strike slowly but fluidly the metal with the tip of the electrode.

After you have successfully got a bead and even a weld line going on a piece of sheet metal, you can go ahead and run the electrode between the two bolt pieces to fill the gap with material.

If you can't manage to get a good bead / seam going try to use other kinds of stick welding electrodes, as they might be better suited for the steel you are working with.



After the first few blobs that you put into the gap, you can remove the clamp and work with the bolt pieces just laying on the metal plate. You will struggle to keep it going consistently but that doesn't matter, keep going at it until the gap on each side looks like in the image.

Once you have filled both gaps on both sides like you see in the picture, use your file to remove as much of the welded material until it can fit into your printed bolt housing.



It will probably take some time until you have filed enough material from the filled gap as well as accidental weld blobs that prevent the bolt from going into the bolt housing.

Make extensive use of your metal wire brush and slag hammer to remove as much slag from the welded seam before you spend much of your time using the file.

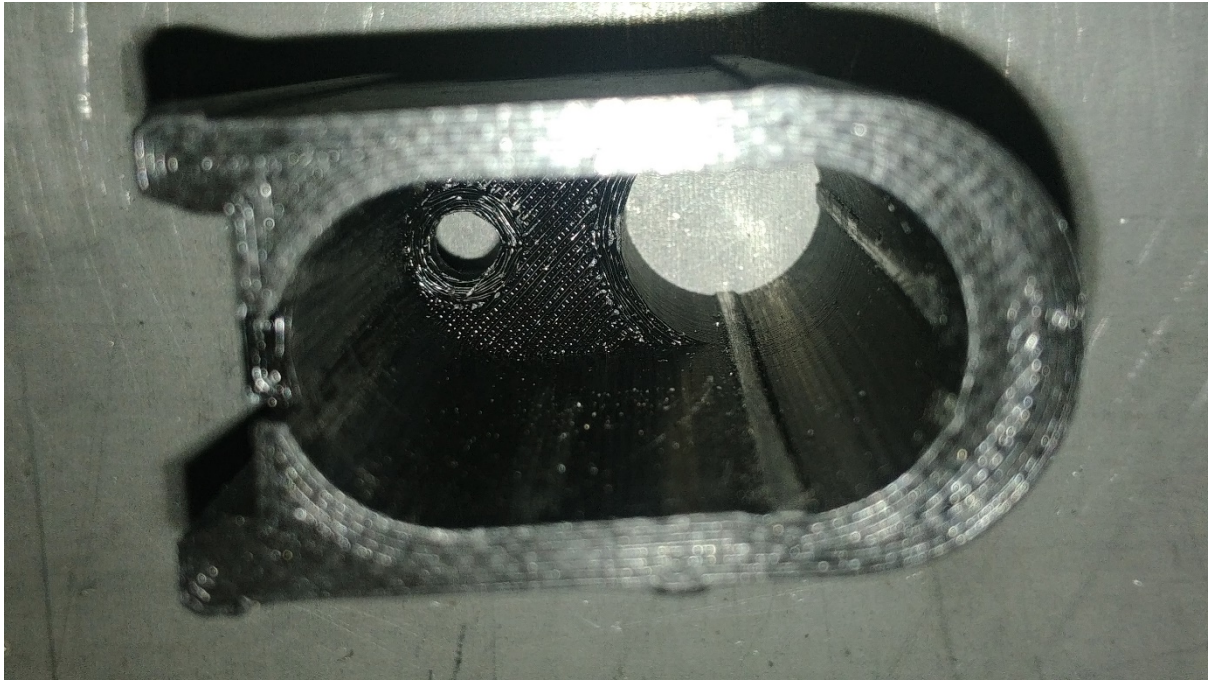

Eventually you should be able to slide the bolt into the bolt housing. Don't try to use too much force getting it in. Try to look meticulously on the bolt for excessive weld material that might prevent the bolt from getting into the housing. You also will probably have to remove material from the steel bolt pieces themselves, especially on the sides to get it to fit in.



Once the welded bolt fits inside the bolt housing use a sharp metal object, a pen or something similar to scratch the outline of the cutout on the bottom of the bolt carrier onto the bottom of the 50mm bolt piece as you can see it in the image.

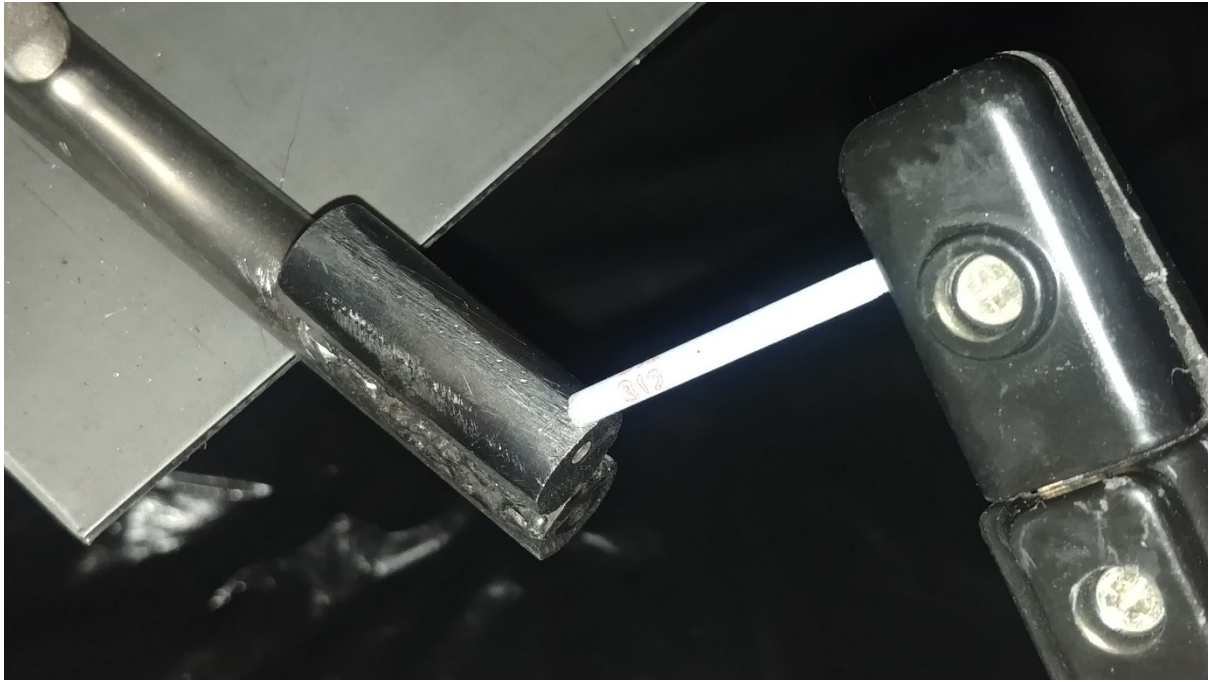

Using one of your partially spent welding sticks that is shorter, add blobs of weld material. Add a blob, let it cool off and then add another blob on top of it until the tower of blobs looks similar to the picture.

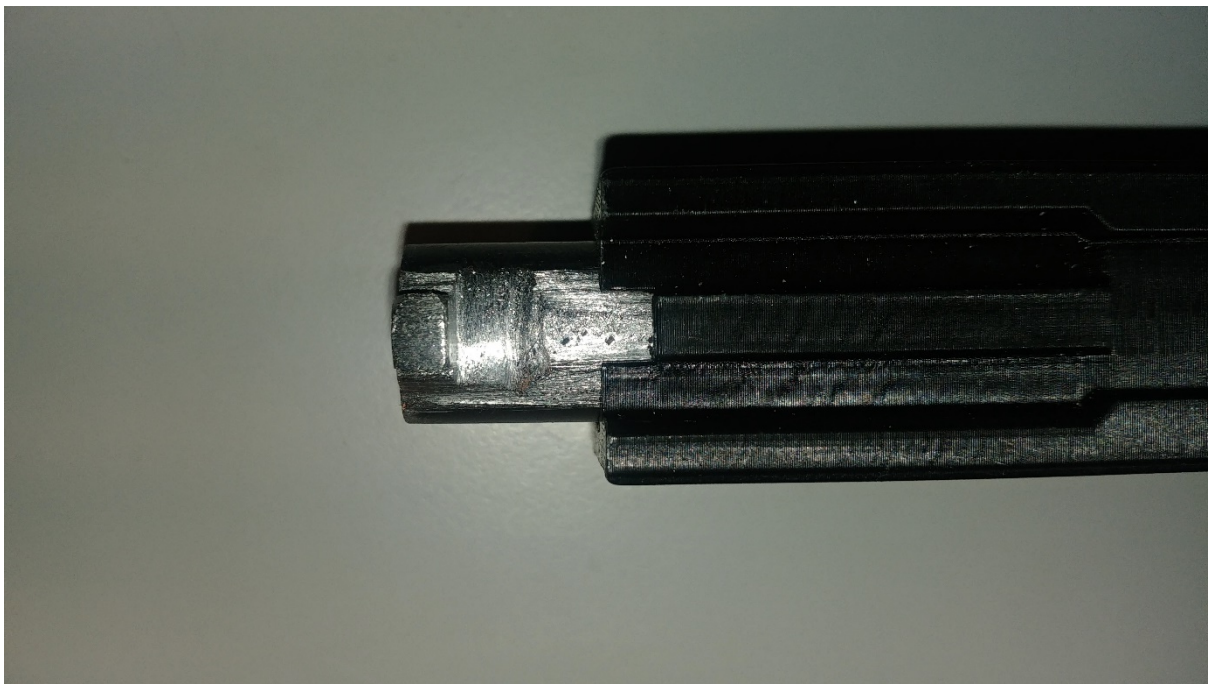
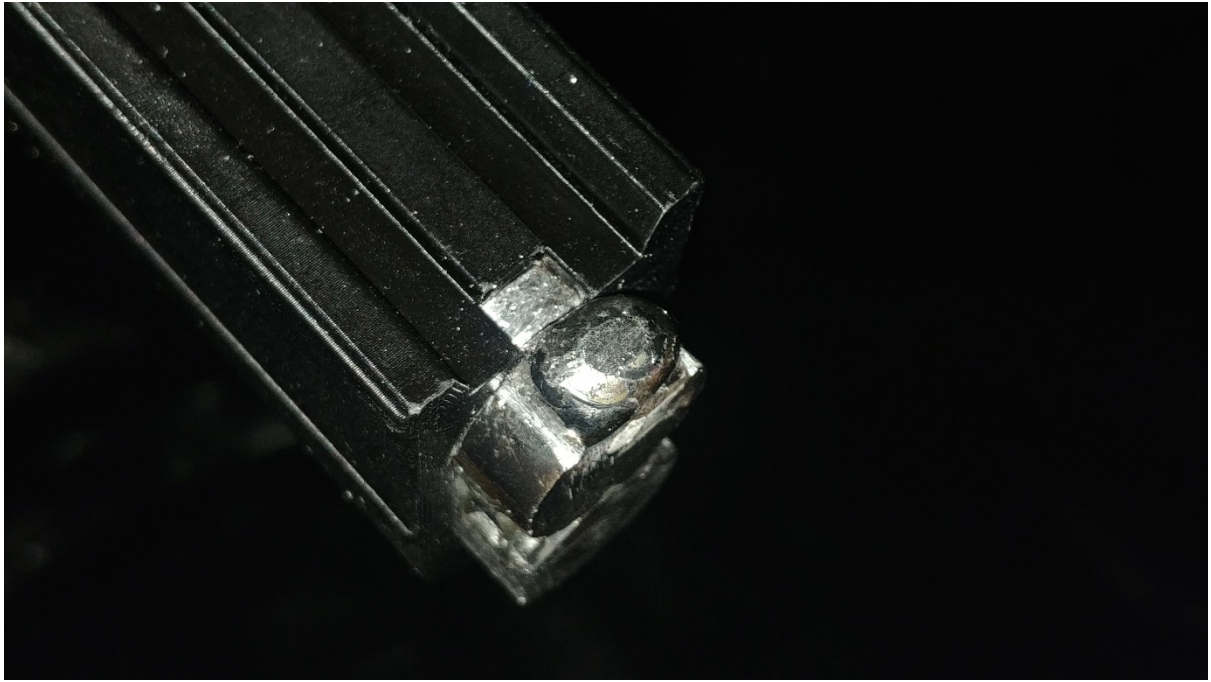

Once your blob tower is high enough and wide enough to cover the cutout you can go ahead and use your metal file to shape it in such a way where it becomes a square that fills out the cutout on the bolt housing.

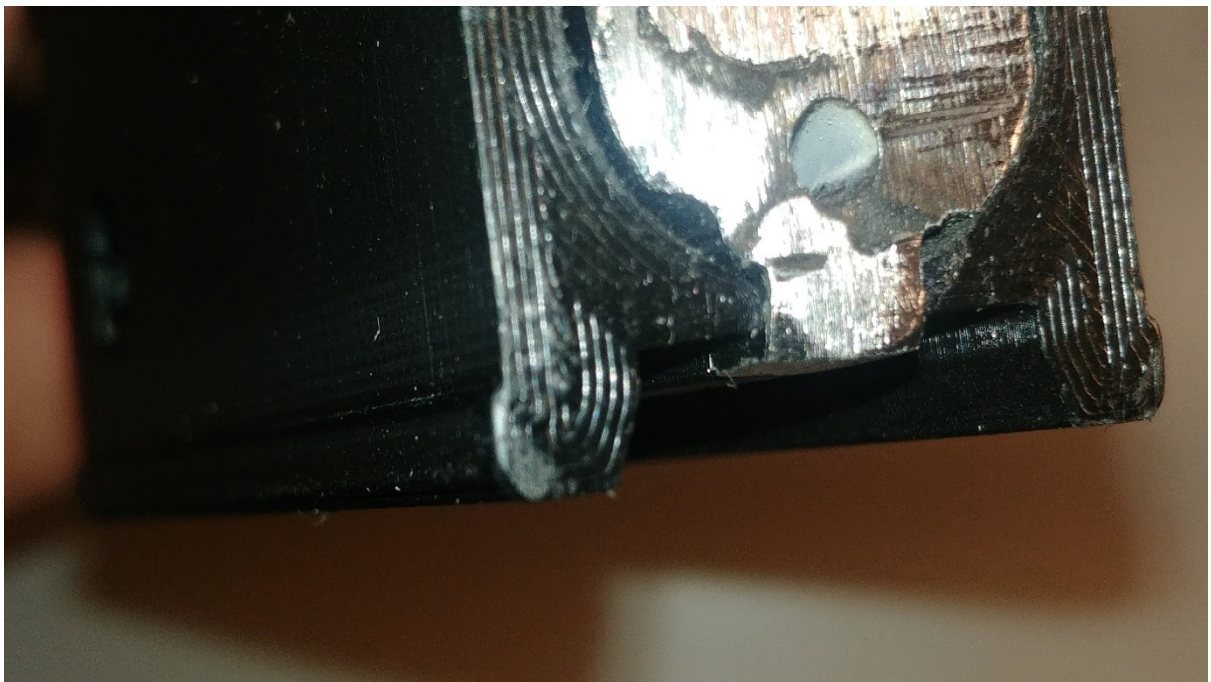
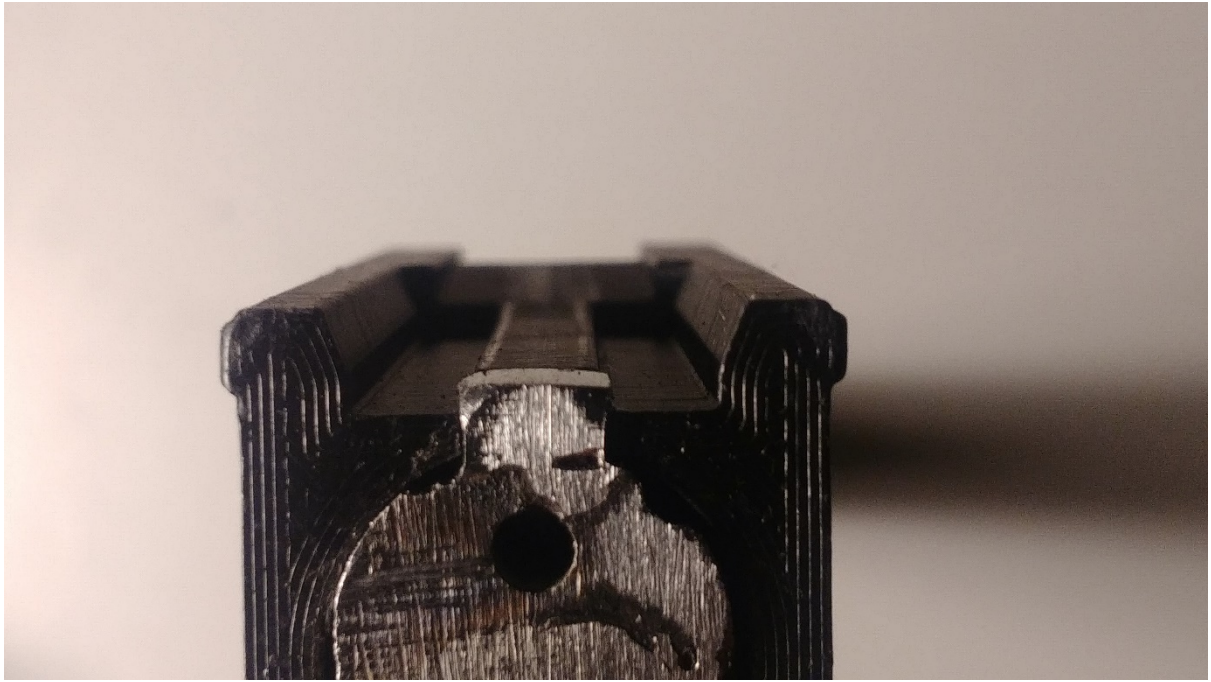

It doesn't have to be perfect but the sides of the square you are creating should follow the sides of the bottom geometry on the bolt housing as you can see it, in the picture.



The behind of the square shape will determine how far you can shove the bolt inside the bolt housing. Remove material from the back side of the square shape, so that you can shove the bolt into the bolt housing.

Do not keep removing material from the back side of the square shape, once the bolt face is only sticking 0.1-1mm out, and more importantly when a gap already appears in the circle shown in the bottom of the picture. If the gap has appeared but the front face of the bolt is still sticking out more than 1mm, use sand paper to evenly reduce the protrusion of the steel face.



Once you have managed to file the square into shape so it roughly fills out the cutout on the bottom of the bolt housing and the bolt in fits inside the bolt housing well while not sticking out too much, you then can go ahead.



Prepare the steel bolt, the bolt housing, JB weld and the tools to apply it and clean the excessive JB weld off.

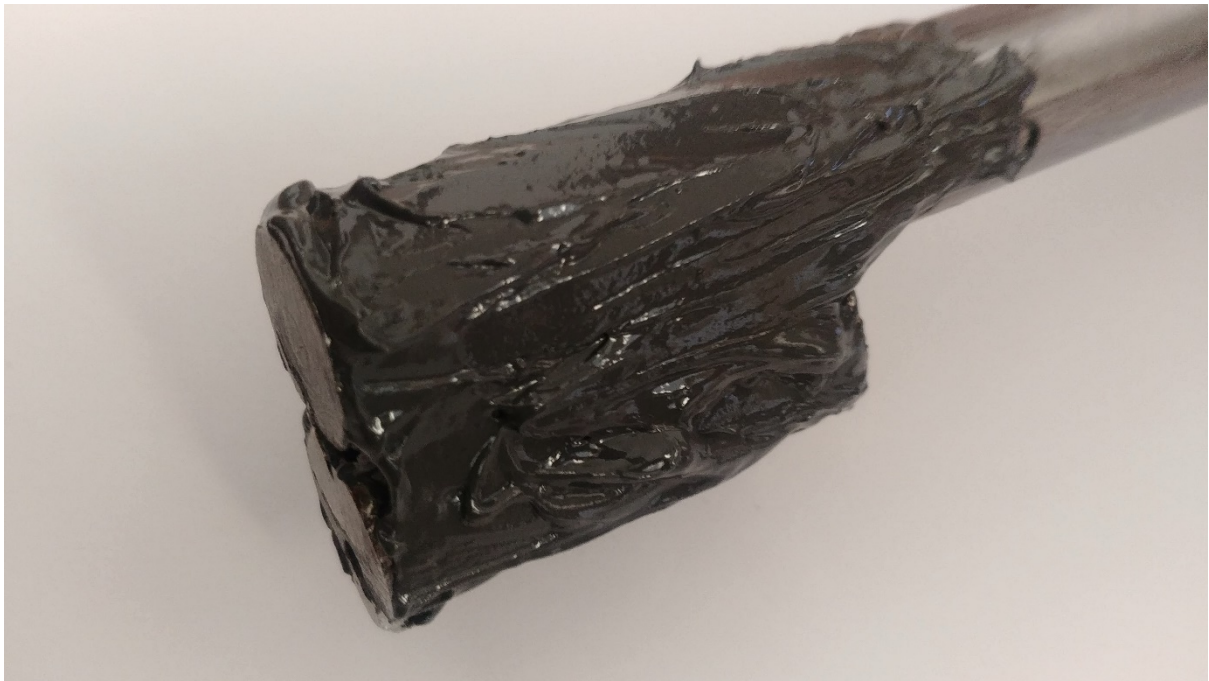

Mix the JB weld very well and then apply it to the steel bolt to the extent that you see on the picture.

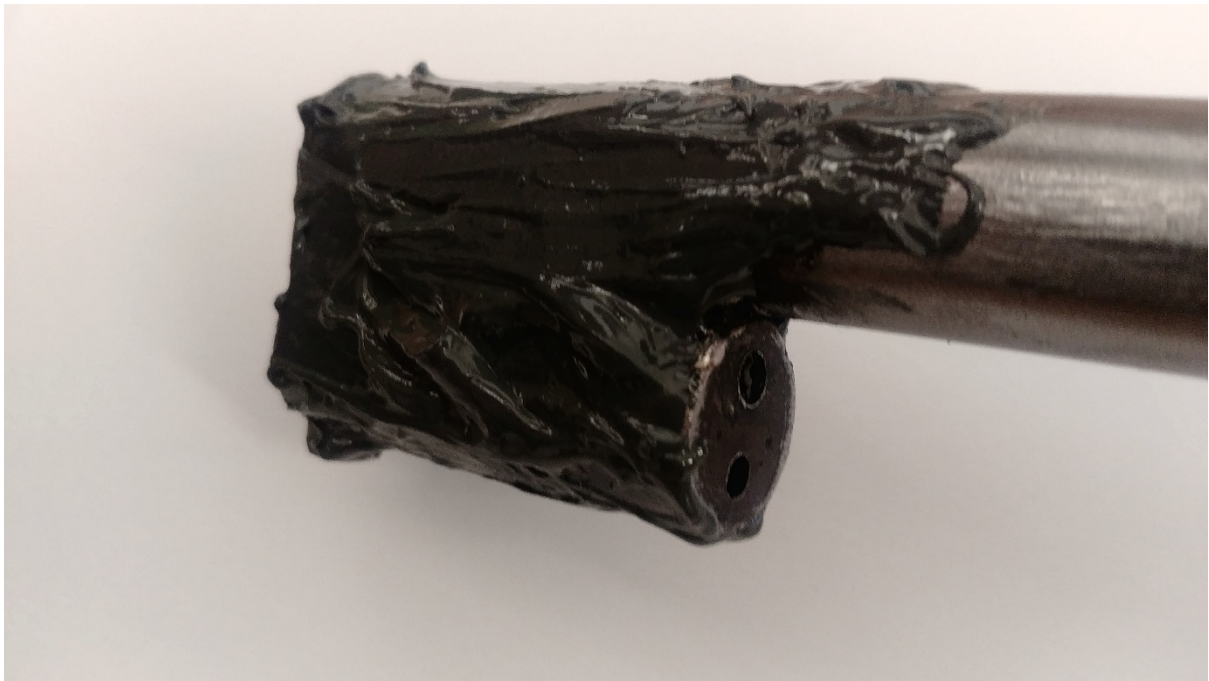

Push the steel bolt into the bolt housing with the JB weld applied on it.

Make absolutely sure that you don't have any JB weld on the backside of the lower bolt rod. It has to stay clean!



Be sure to clean the bolt assembly up to the extent you see in the pictures, before letting it dry.

Let the bolt dry for 24 hours before going ahead with the next steps.

Weldless Bolt Option

Text and pictures by IvanTheTroll

Step 1: Prep Work

Remove all supports from your printed parts. Your Bolt Cutting Jigs should have four upright posts that act as integrated supports – use a screwdriver or pliers to remove these four posts, as you don't need them in place. You don't need to be very precise, just get the posts out of the way. It's fine if a little of the post stays stuck to the jig itself.



Jigs before removing posts



Jigs with posts removed.

You will also need to take your 10x10mm bar stock and cut a ~17.75mm long section from it. Use a hacksaw, your grinding tool, or whatever other tool you used to cut your bolt rods to length. The length of bar stock is beneath the bolt rods in the following picture:



Bolt rods cut to length with bar stock cut to length.

Step 2: Creating Weldless Lower Bolt Rod

For the next step, you will need to make sure you have your bolt rods cut to length (refer to the FGC-9 documentation for this exact length) and your firing pin channel drilled (again, refer to the FGC-9 documentation for the jig and tutorial on how to drill the firing pin channel). I will stress that it is *very* important to get your firing pin channel drilled as straight as you can – It's also a good idea to mark which end of the lower bolt rod you drilled into, as this end of the lower bolt rod should become your breech face. Use a punch or screwdriver to make a small mark on this end of the bolt rod.

Note: I recommend you do these next couple steps outdoors if you are using a power tool to grind. If this is not an option, try and use a room that has tile floor and is easy to sweep in – this process makes a big mess since you are grinding away a lot of metal.

Take your lower bolt rod, one of your cutting jigs, and the same drill bit you used to drill your firing pin channel. Insert the lower bolt rod into the jig *BREECH FACE FIRST* with the firing pin channel lined up with the larger of the two holes in the front of the cutting jig. It is important that you insert the breech face first to ensure things line up. The breech face is whichever side of the lower bolt rod that you drilled into first when drilling your firing pin channel, or whichever end of the rod lines up the best. If your firing pin channel is too far misaligned and you can't get the firing pin channel to line up with the hole in the jig, make a new lower bolt rod and be more careful when making your firing pin channel.

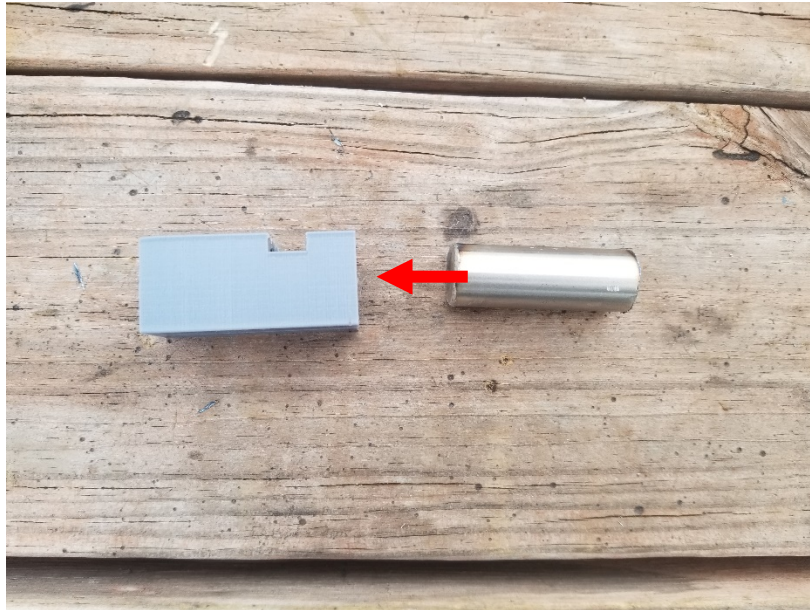

Insert the lower bolt rod into the jig fully – make sure it is inserted as far as it can go.

Assuming you inserted the lower bolt rod with the firing pin channel aligned, take your drill bit and insert it from the front of the jig. It may be a snug fit, but if you can get it to go in (you can tap it in gently with a hammer if needed) then your firing pin channel is close enough to work correctly.



Insert the drill bit you used into the larger of the two holes – the one that lines up with the firing pin channel.

Double check that the bolt rod is still pushed as far into the jig as it can possibly go – this is very important. After checking this, take your vise grips/clamp/vise and clamp down on the end of the jig – this will lock the bolt rod in place. Make sure this is quite tight – don't worry about deforming the jig, you want to keep the bolt rod totally still. **MAKE SURE THAT YOUR DRILL BIT IS STUCK IN FROM THE FRONT OF THE BOLT** – you can't see mine in the picture, but you must make sure it is inserted.



Clamp down tight!

Next, you are ready to start removing material. This will get a little messy, and if you are using power tools you should use safety glasses. Safety squinting and looking away won't work here, as you have to closely inspect how much material you have removed. Get your grinding tool ready and find a comfortable way to control both the clamped bolt rod and the grinding tool – I used one hand on the grinder and one hand on the vise grips, but since your set up may vary, take the time to find a way that you can keep the clamped bolt rod and grinding tool under control.

Now you are ready to remove some metal – you will need to use your grinding tool to make a notch in the bolt rod that follows the shape of the cutout in the jig – about 10mm wide, about 5mm deep. Take frequent stops to check how much metal you have removed, but try to work quickly – removing this much metal makes lots of heat, and your jig will start to melt. I've made four of these bolts at time of writing this, and using the grinder pictured I am able to remove the material before the jig gets totally melted. If you are using a Dremel tool, you can take breaks to let everything cool – if you don't ever get the metal red-hot from heat, you can use water to cool it. But if you do get the metal red-hot, DO NOT use water to cool it off – this can cause weird local heat treating to occur, which could lead to a weak bolt.



Be sure to control your tools! Don't lose control of them and grind something you aren't supposed to.

Once you have removed at least 90% of the metal from the slot, you can remove the jig from the bolt rod. If it is getting melty, wear gloves and use a screwdriver to try and pry the jig off. You can also use a punch to drive the bolt rod out of the jig using the small hole in the front of the jig. Because this jig has been overheated, it isn't reusable, so don't be afraid to break it.

Take your 10mm bar stock and test how it fits into the slot. Usually it won't quite fit right away – you can use a Dremel tool or metal file to remove just a little more metal and get the bar to fit. I don't recommend using a grinder, because removing too much metal can ruin your bolt rod. You will want the bar to fit close to snug in the slot, with about half of the bar stock sticking up out of the slot.



Test fit the bar into the slot in the bolt rod.



Use a metal file to square up and fine-tune the slot in the bolt rods. File a little, test fit the bar, file some more, etc.

Step 3: Creating Weldless Upper Bolt Rod

Without going into too much detail, you will make the upper bolt rod just like you did with the lower bolt rod – only you won't need to use a drill bit to align the firing pin hole, since there isn't a firing pin hole on the upper bolt rod.

Take your rod, insert it fully into your second cutting jig, clamp it in place, then use your grinding tools to cut the slot into the rod. Follow the same steps as in Step 2 with regards to cleaning up the slot after you have removed most of the metal.

As a reminder, a snug fit on the bar stock is ideal (the less it can wiggle towards either end of the rod the better), and half of the height of the bar stock should be sticking out of the slot when the bar is placed into the slot.



Correct fitment of the bar stock into the slot

Step 4: Assembling the Bolt

Once you have slotted both bolt rods, take your bar stock and both rods and lay them out like seen in the picture below. Your bar stock might not sit perfectly flat/straight, but so long as the top of the upper bolt rod touches the bottom of the upper bolt rod, then you've cut your slots properly. If the bolt rods have a gap between each other because the bar stock doesn't fit deep enough into the slots, you will need to make the slots a little deeper.



Layout of the weldless bolt. Make sure there is NO gap between the bolt rods. If there is, you need to make the slots deeper.

After ensuring that the bar stock can fit between the bolt rods without any gap between the two bolt rods, you are ready to do a mock-up fit of your bolt assembly. Take your metal parts and your bolt housing. Insert the metal parts into the bolt housing as shown in the picture below. Make sure that your bar stock is centered when it passes into the bolt housing. If you didn't make sure that there was zero gap between the top and bottom bolt rods, you won't be able to get the metal parts to fit inside the housing – go back to the previous step and fix this. It may be a little hard to get your metal parts inserted the first time – the bolt housing is intentionally tight to help align the metal parts.

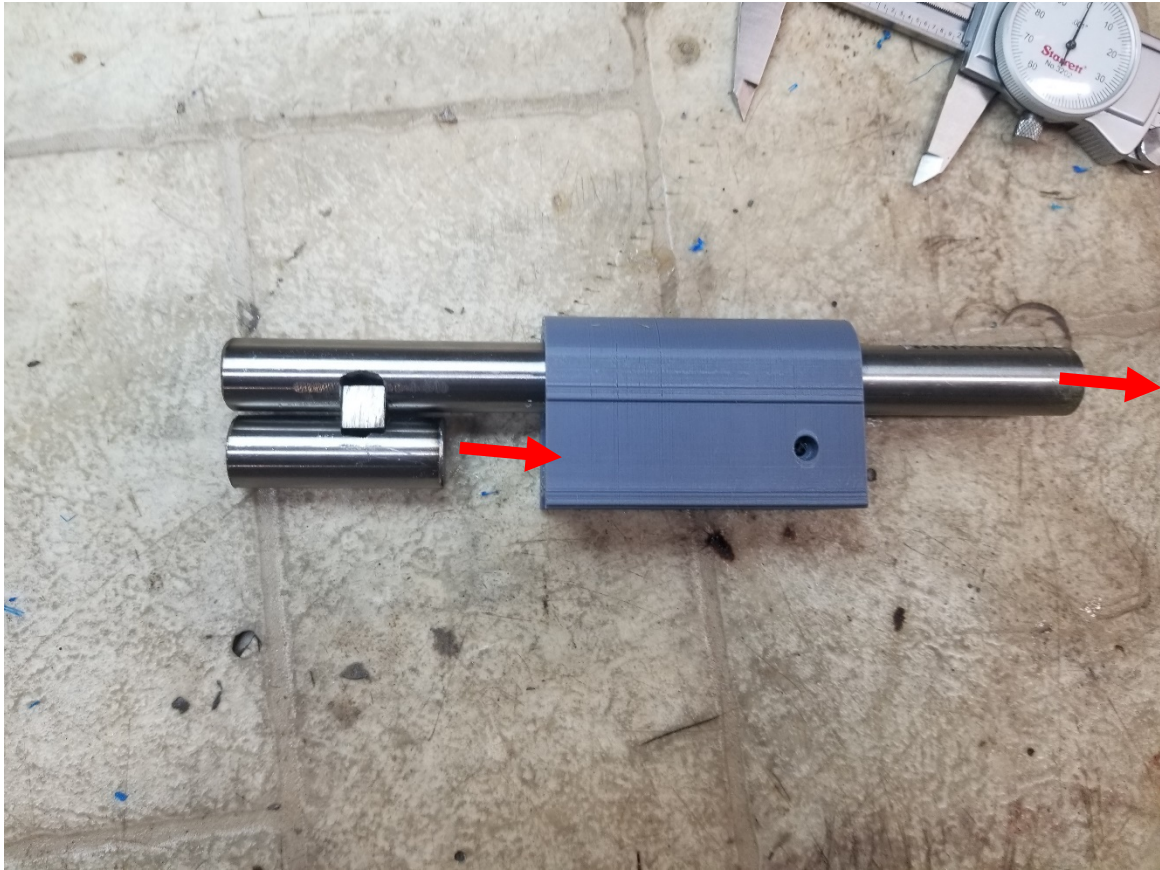

Carefully guide the metal parts into the bolt housing. You might need to tap them in gently with a hammer the first time.

After fully inserting your bolt rods, I recommend you take the drill bit you used to drill the firing pin channel, your FGC-9 headspacing jig (make sure you've read the FGC-9 documentation to understand this tool), and your FGC-9 barrel, as well as a spent/fired cartridge (you can use a live cartridge but be careful). With the cartridge in the chamber and the drill bit sticking out of the firing pin channel, use the headspacing jig to check how the firing pin channel and cartridge/primer align. If the drill bit in the firing pin channel points right at the middle of the primer, you've done well. If it doesn't line up, you will probably have to make a new lower bolt rod – pay close attention when drilling your firing pin channel.

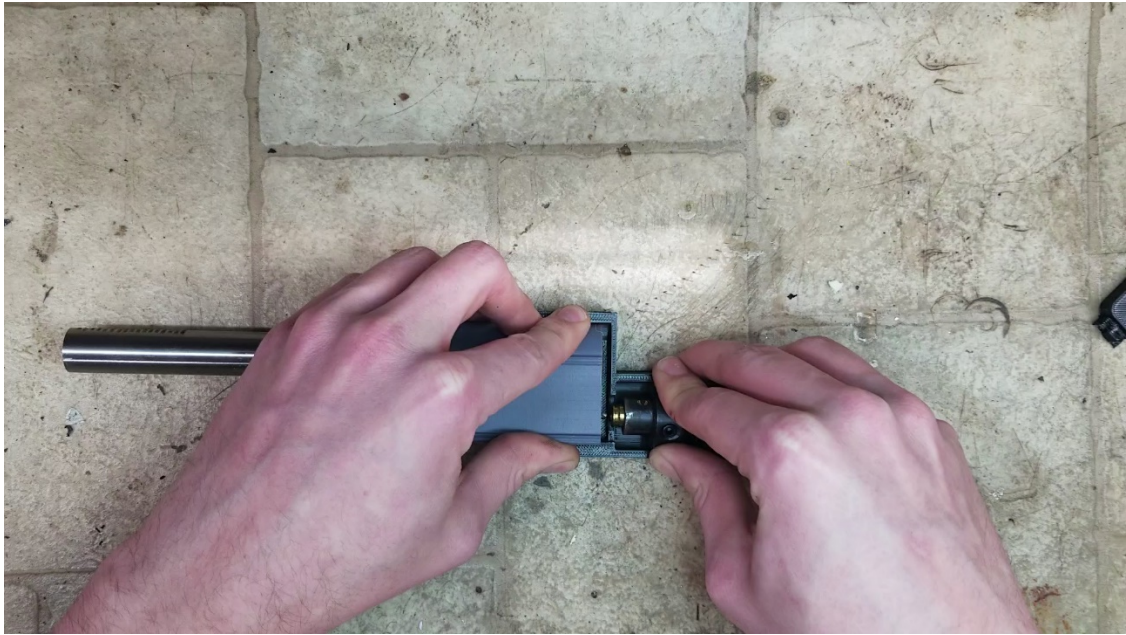

Checking firing pin alignment

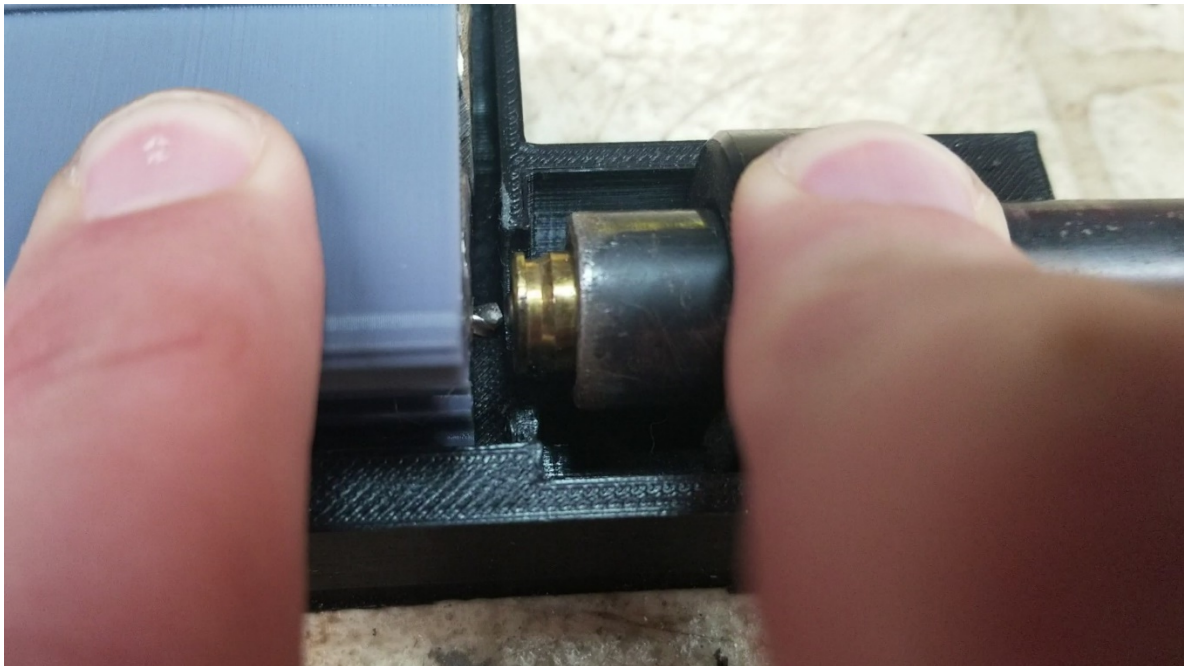

Get up close and check – this firing pin channel is well-placed.

After checking alignment of the firing pin channel, you are ready to JBWeld your bolt assembly into the housing. This step will be messy – don't wear any nice clothes, do not work near carpet, and you may want to wear gloves. Start by mixing a large amount of JBWeld – about 1/3 of each tube should be used for this step. When using large amounts of JBWeld like this, you will need to mix the two parts for about 5 minutes to ensure it is fully mixed.



The minimum amount of JBWeld you should use. Mixing more than this amount is a good idea.

After mixing, use a cheap screwdriver, popsicle stick, or other tool to smear JBWeld on the inside of the bolt housing. Apply lots of JBWeld, but try to leave an even coat – you don't want big blobs, you want it spread out on the inside of the housing.



Apply JBWeld to the inside of the housing. Use your tool to spread it out.

Next, I recommend you use brake cleaner/degreaser to clean all the metal parts – this isn't required but will help make a stronger bolt. After cleaning the metal parts, fill the slots in the upper and lower bolt rods with JBWeld. Make a big blob, and ensure the slots have as much JBWeld in them as you can fit.

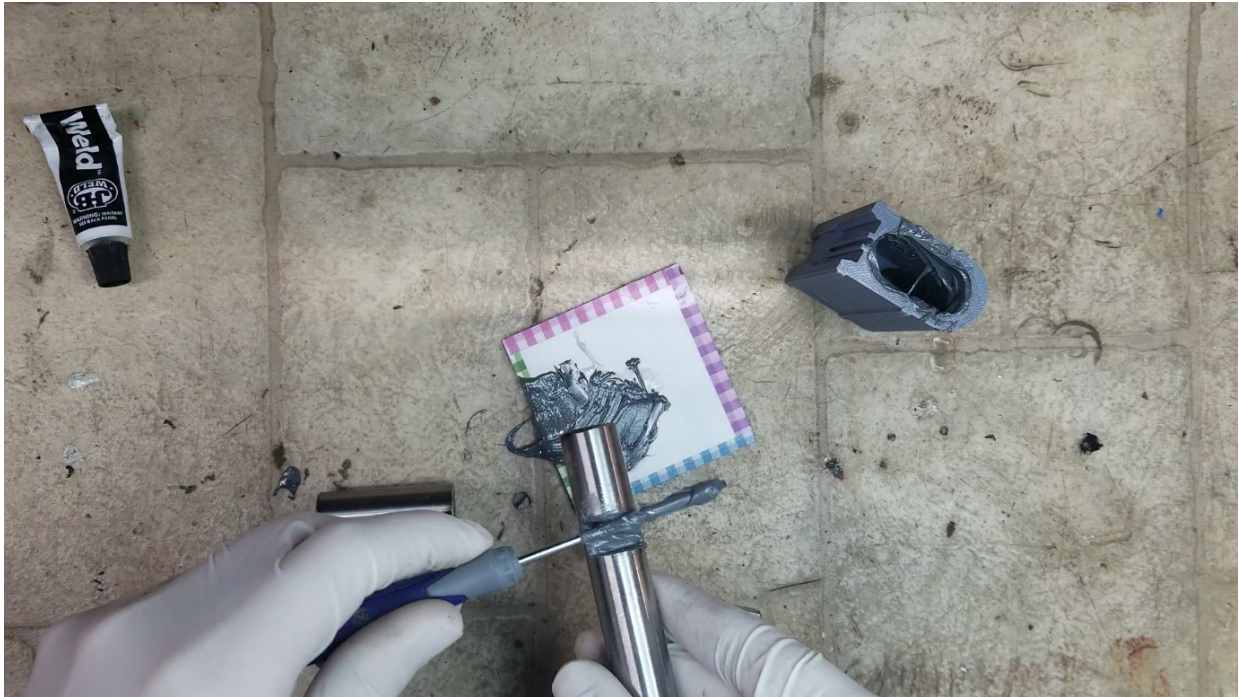

Fill the slots.

Place the bar stock into the lower bolt rod – JBWeld will squish out. Try not to wipe this up – you want to leave it squished out. Squish the lower bolt rod and bar stock into the upper bolt rod – more JBWeld will squish out.



Squish the rods together.

Now, insert the bolt rods into the housing. As JBWeld squishes out, try and guide it into the crevasse between the bolt rods and the housing. You want to cram as much JBWeld between these parts as you can



Smush the bolt rods down into the housing. Smear any JBWeld that squishes out onto the bolt rods and back into the housing.

Push/pull the metal parts until they are fully seated into the bolt housing. Shove any JBWeld that squishes out back into the gaps between the bolt rods and the housing.



Pulling the bolt rods until they are fully seated.

Smearing excess JBWeld back into the gaps.

Take your extra 3mm drill bit and coat it in JBWeld – build up lots of JBWeld on the drill bit, fill the flutes with JBWeld. After coating the drill bit, you will insert it into the slot at the bottom of the bolt housing. Insert it until it stops – some of the drill bit will still be sticking out, this is fine for now.



Apply lots of JBWeld!

Smooth out the JBWeld along the bottom of the drill bit/bolt with your finger. Make sure plenty of JBWeld is smeared over the bottom of the drill bit/bolt, as seen in the following picture.



At this point, most of the messy work is over. Use a rag to wipe up any JBWeld on the exposed section of the upper bolt rod. Clean up any JBWeld that you got on the sides of the bolt housing. Finally, you will need to clean out any JBWeld that you got into the firing pin channel/firing pin housing. I usually just use a rag and a screwdriver for this. Use the screwdriver to guide the rag into the rear of the bolt and mop up all the JBWeld that you see. Try and get as much of it out as you can.



This JBWeld needs to be cleaned out.

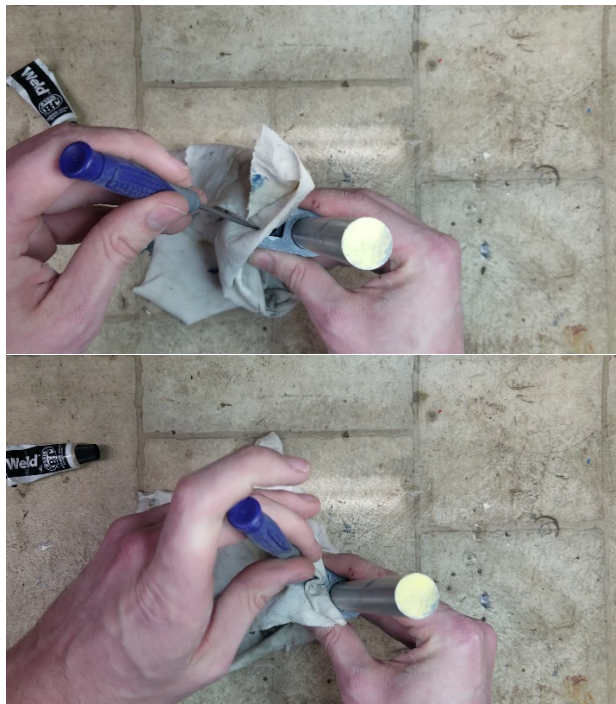

Mop up all that JBWeld!

You're finally done making messes – set your bolt upright for at least 24 hours to let the JBWeld set up. I recommend you use a clamp on the outside of the bolt housing while the JBWeld sets up (the clamp doesn't need to be very tight, just holding everything steady).



Bolt assembly clamped in place while the JBWeld cures.

After the JBWeld has cured for 24 hours, use a hacksaw or Dremel tool and a file to cut the 3mm drill bit off – you will need to make sure you cut it off perfectly flat with the face of the lower bolt rod. I recommend you cut 90% of the length of the drill bit off with your hacksaw or Dremel tool, then use your metal file to file down the firing pin until it is flush with the face of the bolt. You may also have to take the drill bit you drilled out your firing pin channel with and drill any JBWeld out of the firing pin channel itself.



Dremel off most of the drill bit, then use a file to make it flush with the bolt face.



Drill bit filed flat with the bolt face.



Side view – note that the face of the bolt is flat and the drill bit does not protrude.

With this step complete, your bolt is done. If you are making an FGC-9 MKII, you will need to drill the recess for the charging handle into the upper bolt rod – refer to the main FGC-9 MKII documentation for the process on doing this.

Weldless Bolt FAQ/Troubleshooting

Q: What sort of round counts should I expect? What ends up breaking?

A: While this bolt is by no means stronger than a proper welded bolt, I have put 500 rounds through one and experienced no issues. If I had to guess, either the drill bit will come loose and the bolt will lose it's ability to pick up rounds out of the magazine, or the JBWeld holding the bar stock in place will crack and the bolt rods will become wobbly. If this happens, STOP USING THE BOLT- I'm sure the gun won't feed right if this happened, so if you have a weird malfunction and the bolt feels wiggly, consider the gun out of commission.

Q: What sort of reliability should I expect?

A: Reliability has been great with the bolts I've made - on par with the welded bolts. It's pretty amazing how well the setup itself works, I did not expect it to work as well as it has.

Q: Why am I getting light primer strikes or failures to extract?

A: Refer to the main FGC-9 MKII documentation/troubleshooting tips for issues like this. It is very important that you headspace weldless bolts per the instructions in the documentation because of the possibility of the two bolt rods not being perfectly aligned when making a weldless bolt.

Q: Can I just use a 3mm rod instead of the 3mm drill bit when JBWelding it into the bottom of the bolt?

A: Maybe, but it will not be as strong as using a drill bit. You can get a set of 10 3mm drill bits for around \$5 most places - cheap Chinese ones are fine for this application.

Drilling the charging handle recess

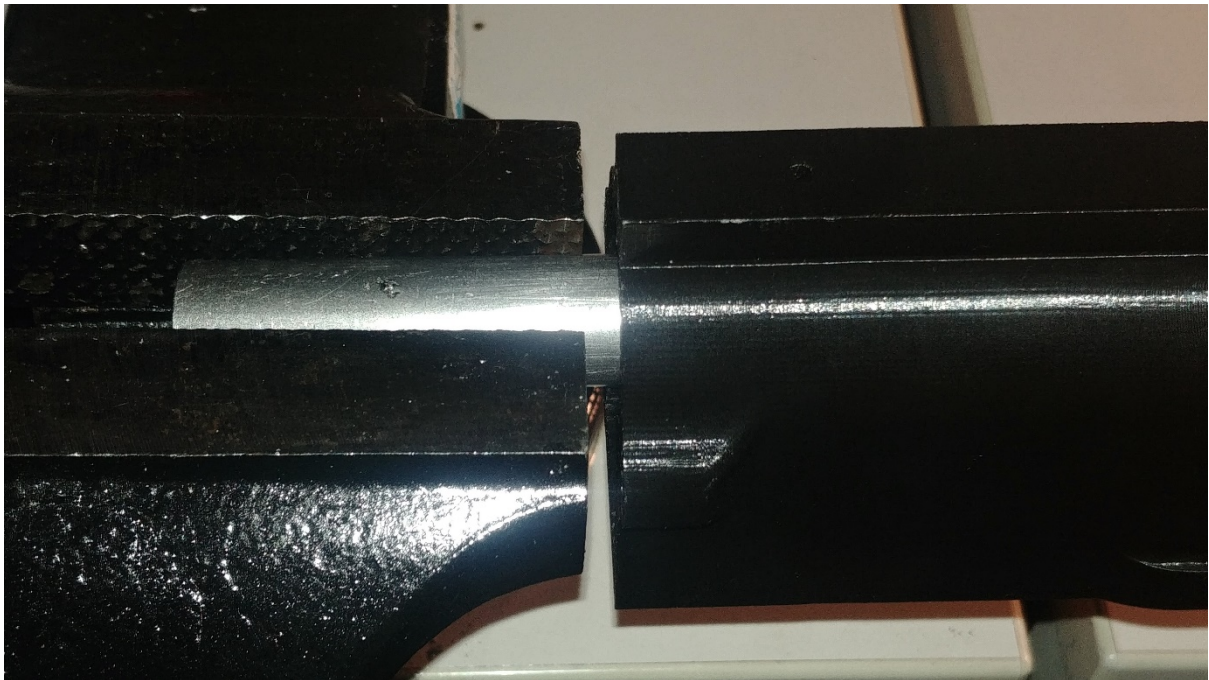
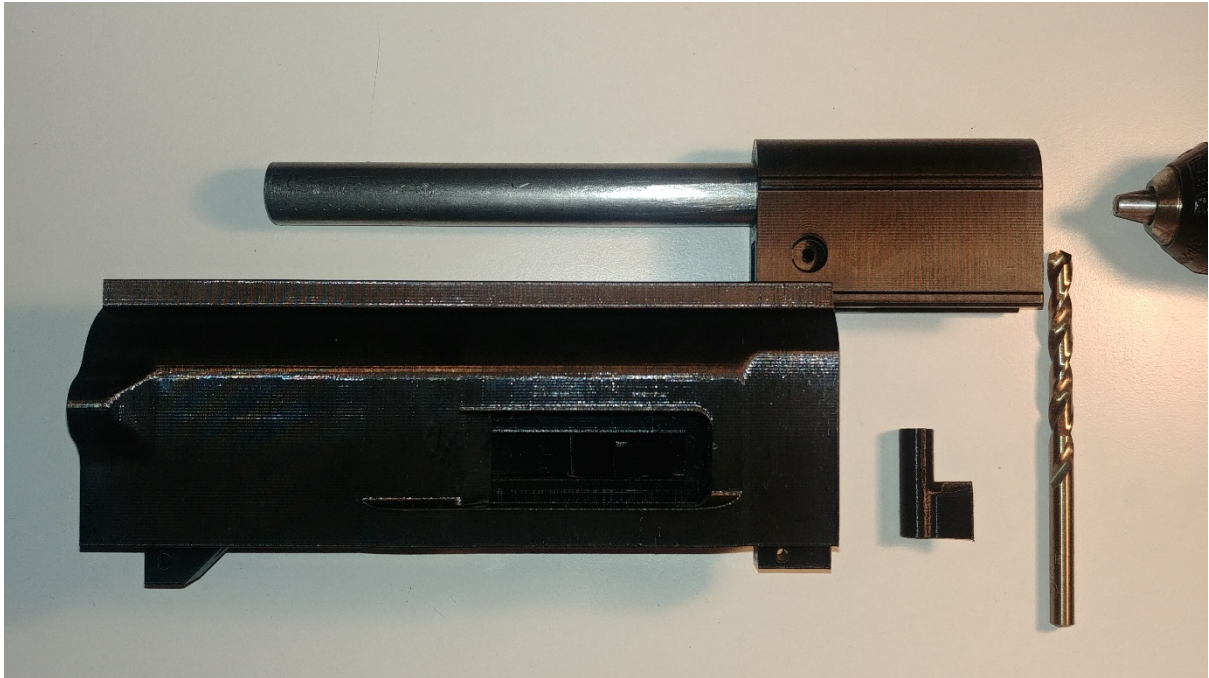

Prepare your power drill, upper receiver, bolt, drill recess jig and a 7mm diameter drill bit. Insert the bolt into the upper receiver. Insert the drill recess jig into the front of the upper receiver. Making sure the bolt does not fall out, clamp the long bolt steel piece between the jaws of your vise. Have as much as you can of the bolt clamped in the vise while still having the bolt be at the end on the inside of the upper receiver.

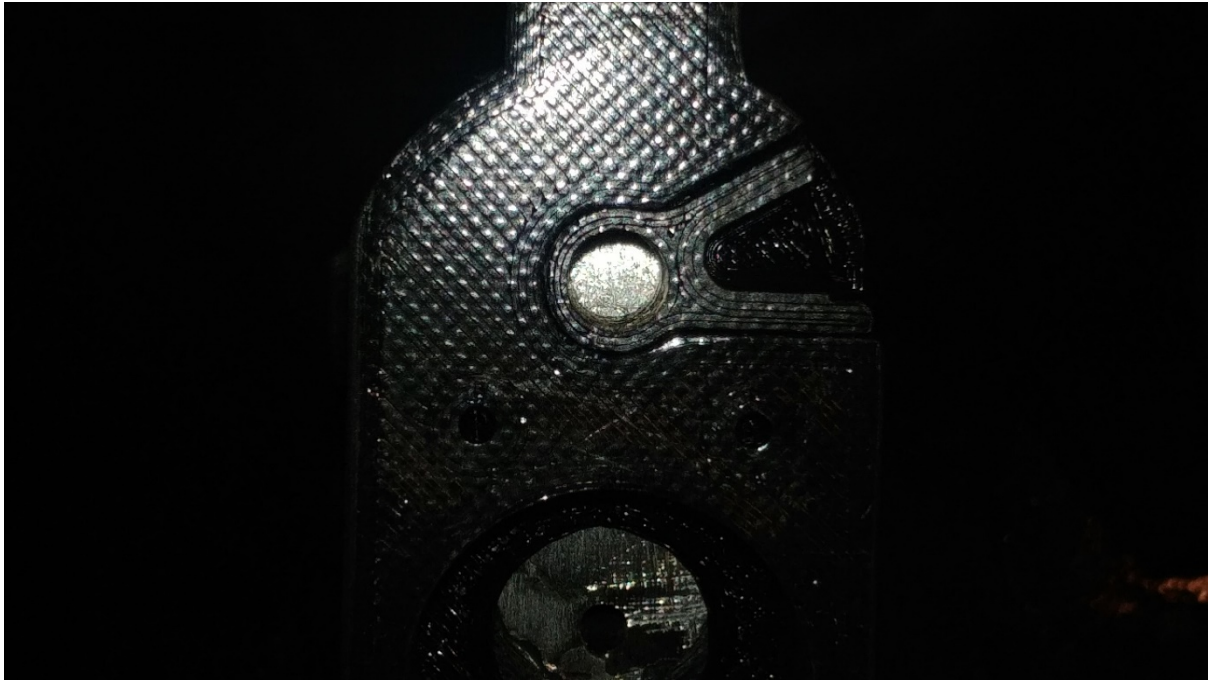

Apply cutting fluid spray and then use your 7mm diameter drill bit to drill into the opening in the recess jig. Push the power drill forward with force trying to drill as straight as possible at the same time.

Only drill a millimeter or two to at the beginning to get an idea how fast you are removing material while drilling. Be sure to constantly remove steel shavings possible with an air spray can or simply use your cutting fluid spray and a brush of some sort.



Your goal is to drill into the bolt face so that you end up with a recess that is 6mm +/-1 deep at the EDGE of the bottom of the recess.

Measure this by using the depth rod of your caliper and have the bottom of that rod butt up against the bottom at the edge of the recess. When you measure at the center of the recess you might measure around 8mm, the reason is that drill bits have a 118° degree tip usually, hence the difference in dimensions center vs edge.

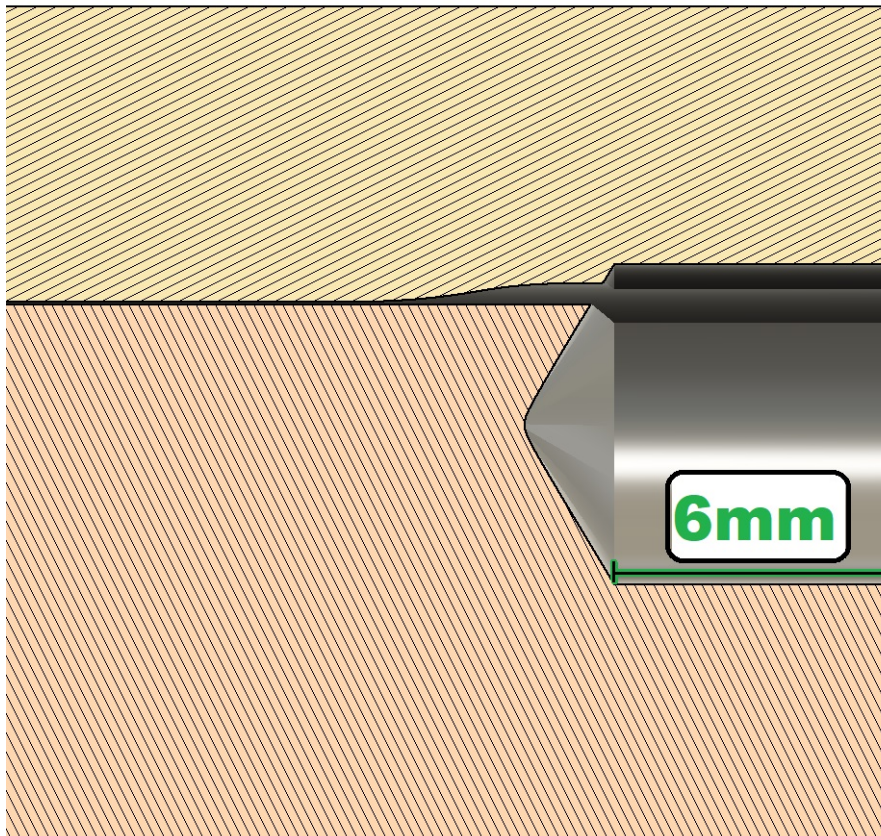

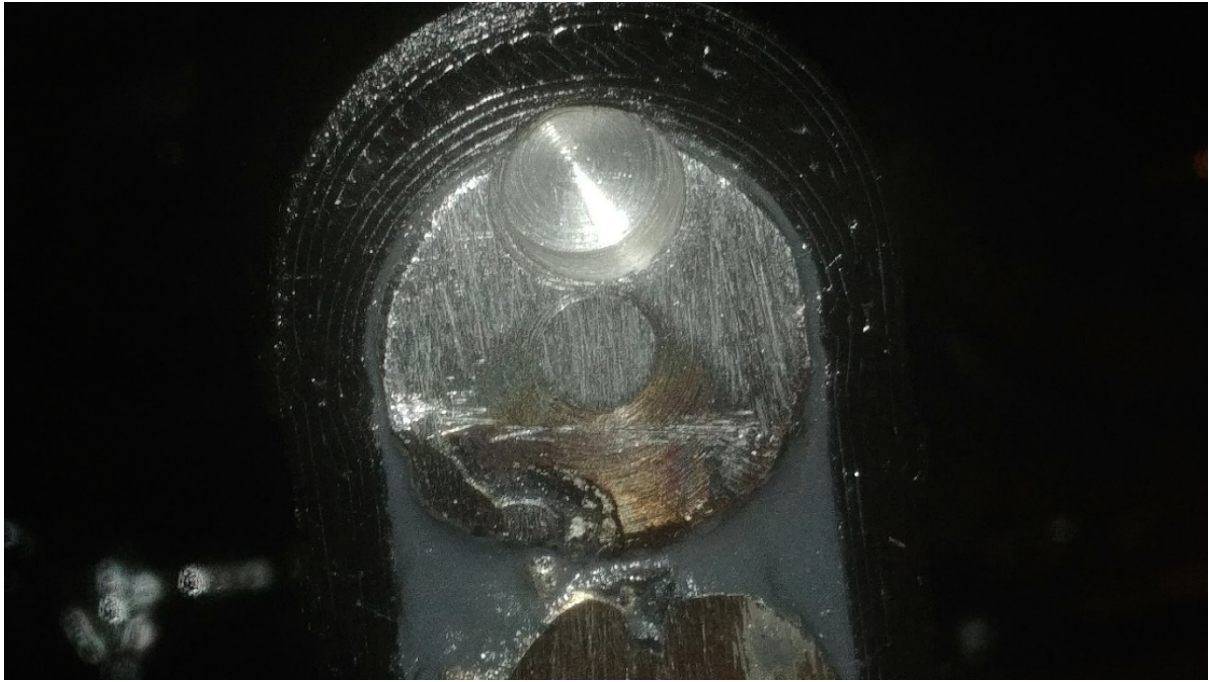

To help the charging handle go into the recess during operation, use sand paper to deburr/ add a radius to the edge of the recess entrance.

Preparing the Fire control group

BEWARE:

YOU NEED TO MAKE SURE THAT THE PARTS FOR THE 3D-PRINTED FIRE CONTROL GROUP ARE PRINTED PROPERLY ON A CORRECTLY ASSEMBLED PRINTER.

FOLLOW THE ASSEMBLY INSTRUCTIONS CAREFULLY!

AN IMPROPERLY PRINTED OR INCORRECTLY INSTALLED FIRE CONTROL GROUP CAN LEAD TO UNSAFE FUNCTION OF THE FIREARM INCLUDING ACCIDENTAL FIRING OF THE FIREARM.

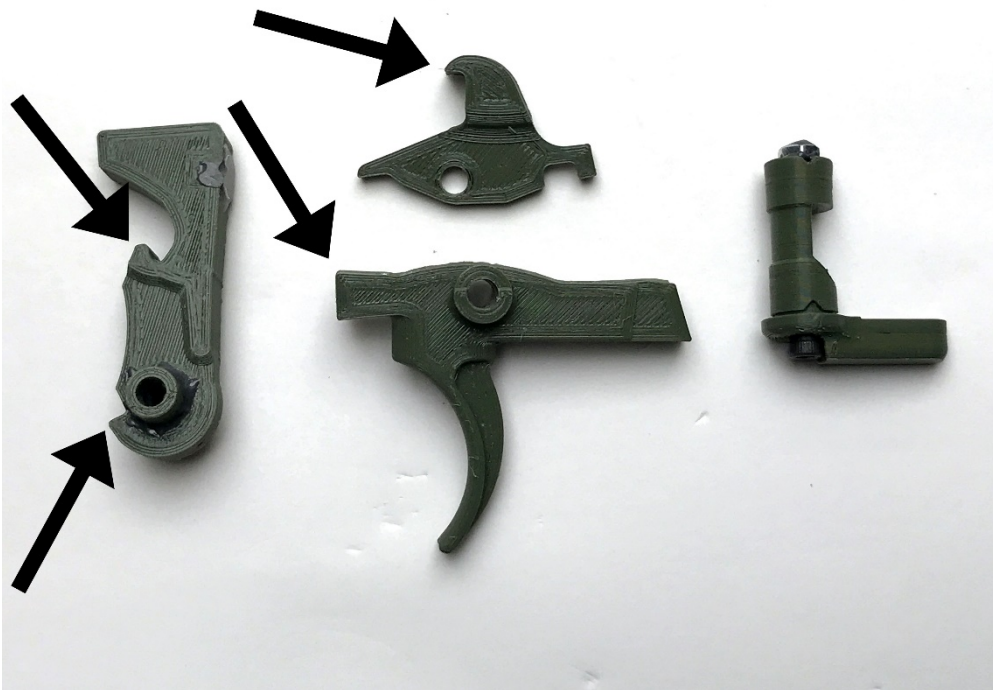

When taking these 3D-printed fire control group parts off the print bed, be very careful.

Do not damage the sear surfaces. Refer to the photo if you are not sure where the sear surfaces are.

Take your time removing the support material. These are delicate precision parts, treat them as such.

Refer to the included support removal videos.



Use a 4mm drill bit to drill out the holes of the trigger, hammer and the disconnecter. It is important to drill straight. Drill as little as possible.

Drill carefully, stop and test whether the pin can pass through the holes without excessive resistance before drilling again.

You do not want the pins to be too loose.

This is especially true for the trigger and disconnecter, as the AR-15 trigger pin that will go through these two components will be slightly smaller in diameter than the DIN pin for the hammer.



Clear out the support material from the internal channel of the trigger, take extra care to remove the brim.

The disconnecter must be able to move freely inside the trigger channel without getting stuck, this is very important, use sandpaper if needed.

Again, do not damage the sear surfaces while you clean up the parts.

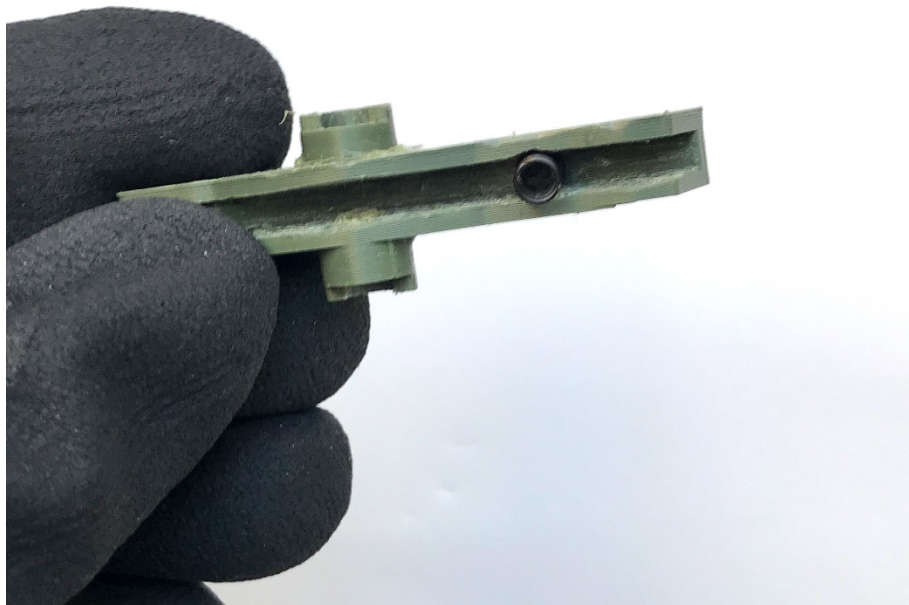
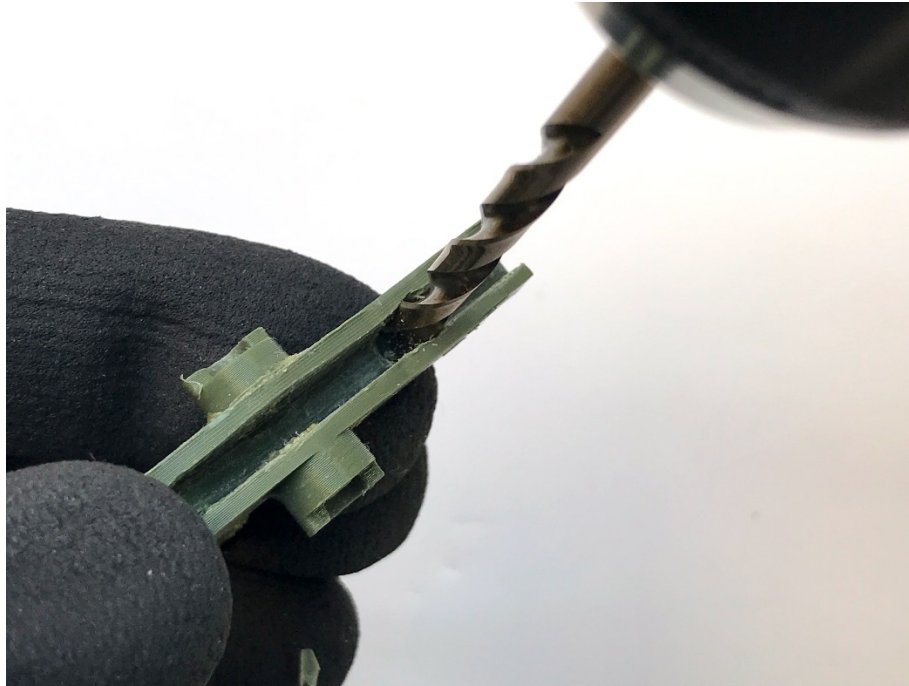

If your disconnecter spring does not fit into its designated recess inside the channel of the trigger because it is wider on the bottom, use your 4mm drill and carefully remove some material from the sides of the trigger channel.



Before going ahead take the DIN 84 screw and screw it partially into the cavity on the face of the hammer, once you made sure it does screw in, screw it out.

Mix up some JB Weld and use something like a nail or toothpick to apply it into the hole. Add some JB weld to the threads of the screw and screw it into the hammer. It does not have to be completely flush with the face of the hammer.

Don't screw it in deeper than the face of the hammer.



Add a good amount of JB weld to the top of the screw.

After 12 hours of letting the JB weld dry, take sand paper or a finer file and sand/file the excess dried JB weld off the top of the screw so that the front surface of the hammer is flat again.

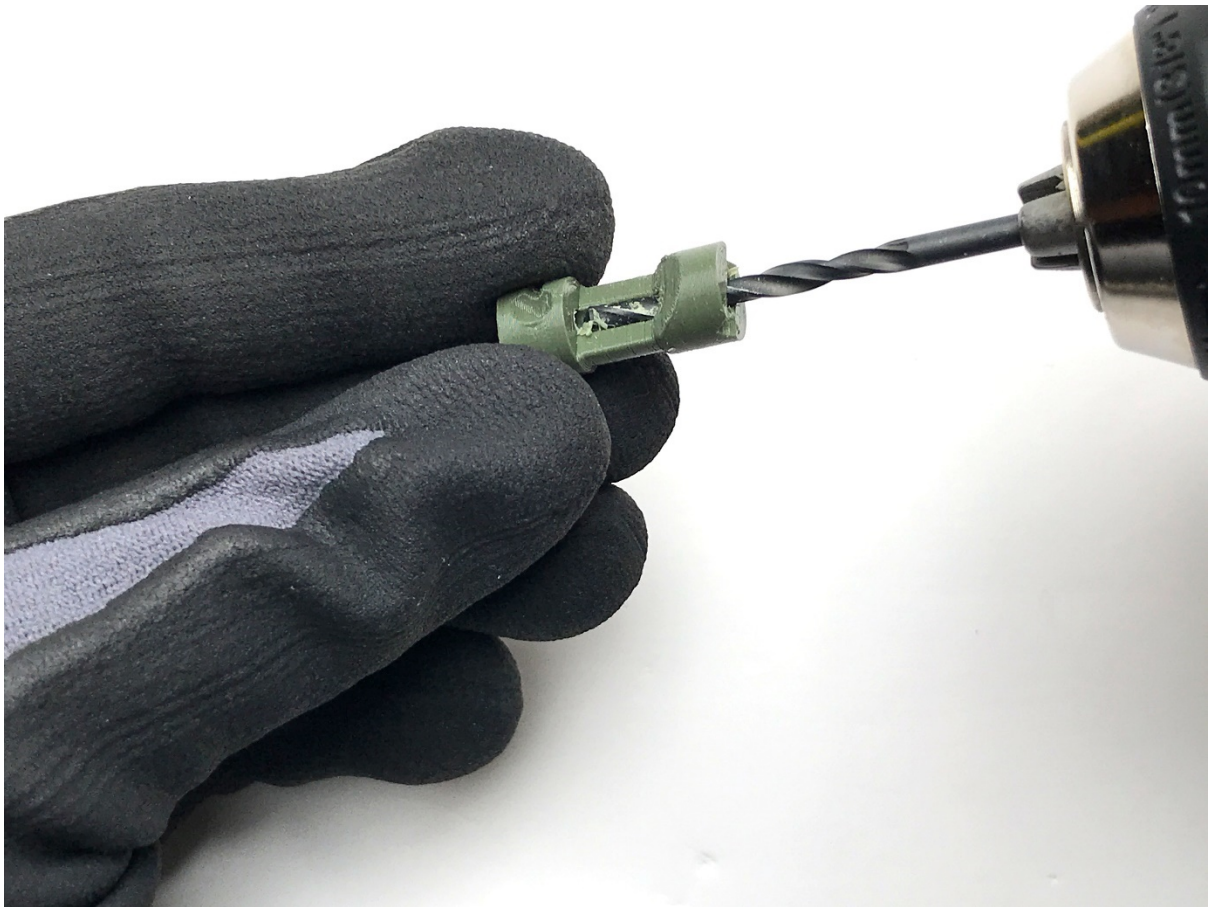

Take your safety selector drum and the safety selector lever and drill out the holes on these parts with an 3mm diameter drill bit.



Ensure that you remove any print debris or brim from the drum, so that the locking / alignment tabs on the levers can fit inside the slots on the drum.

Attach the lever to the drum. The correct orientation is important, refer to the photos.

Insert the M3 30mm long socket head bolt through the safety lever and drum.

Use a M3 nut to secure the two parts but do not over-tighten the nut or the drum might get deformed.

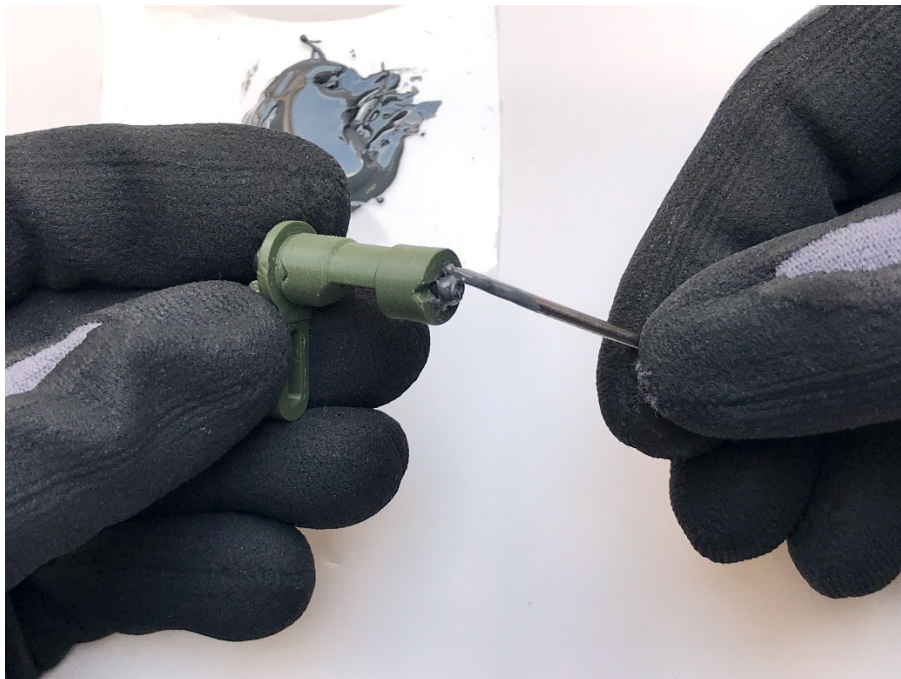

Use a dremel tool with a metal cutting disc to cut off the part of the socket screw that is sticking out of the nut.

Remove the nut afterwards and then add some JB weld to the threads on the end of the screw.



Now screw the nut back on and then add some more JB weld onto the nut.

Let the JB weld dry for at least 12 hours before further use of the fire selector.

Modifying Chinese Glock Mag Springs

Text and pictures by BoostWillis



Instead of leaving it flat like in the picture on the left,

bend the top coil with your pliers upward to match the pitch of the coils below it like shown in the right picture.

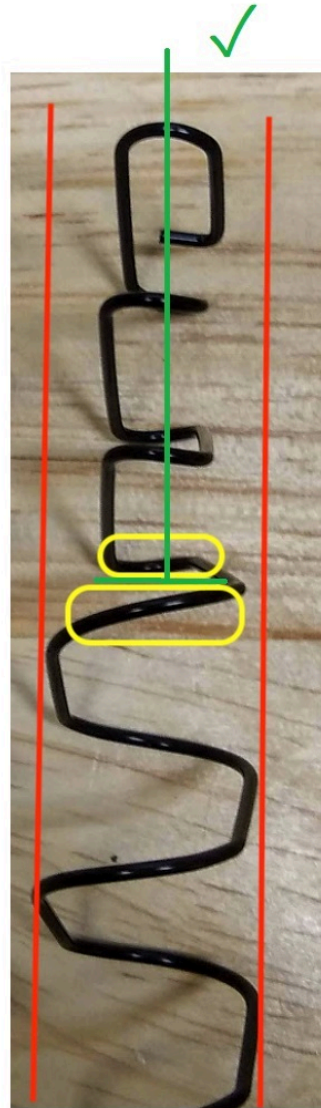
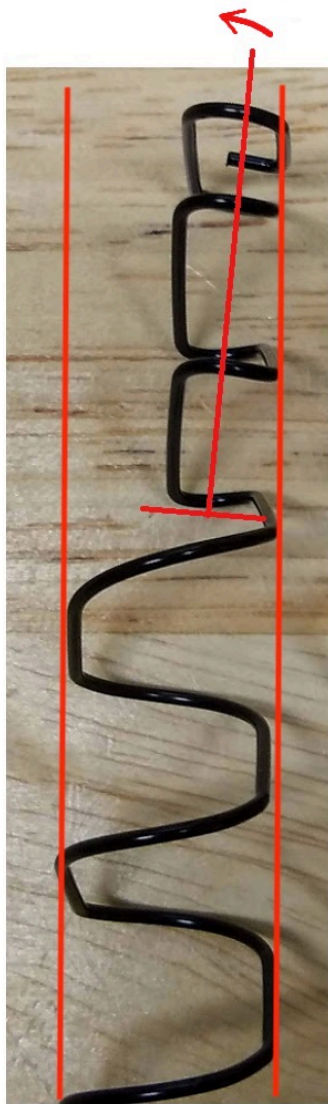

As you can see from the red guide lines, the spring in its initial state on the left has a bias toward one side.

Refer to the marked yellow boxes for where to bend the spring with your pliers to correct it.

You want the top narrower coils to be centered on top of the spring.

It doesn't have to be perfect.



Overall the spring is too wide causing unnecessary friction inside the mag and robbing you of useful spring pressure.

This is where the vise comes in.

Compress the spring in the vise as shown in multiple spots along its length.

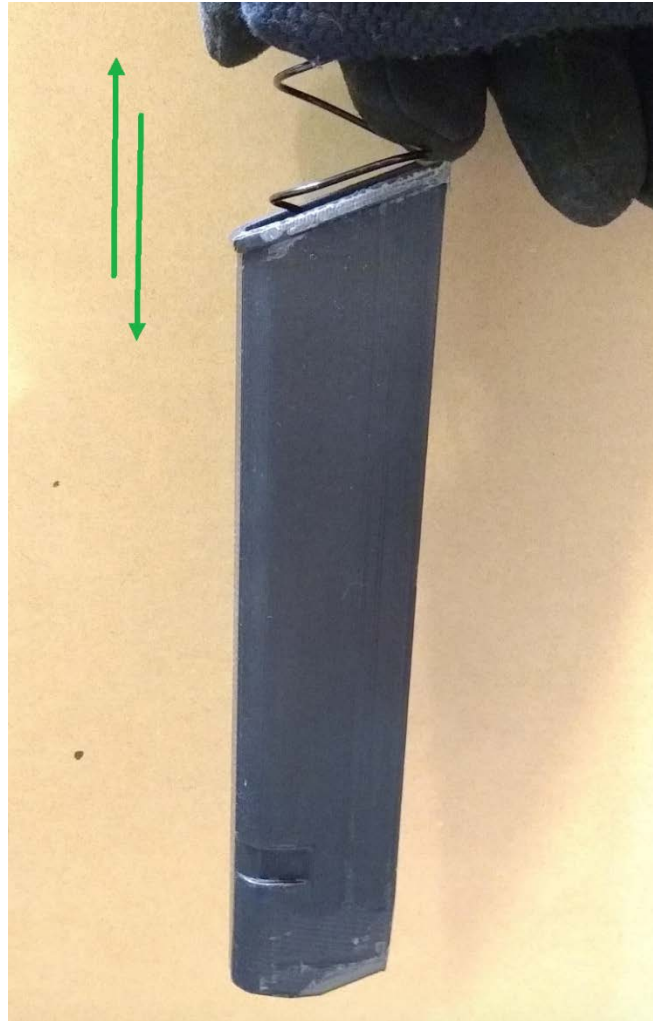

Ignore the narrower coils toward the top of the magazine, but focus on the full width coils that make up the main section of the magazine spring.

Use the magazine body as a guide.

If you slide the spring into the magazine body and turn it upside down, you should be able to shake it out without too much effort.

You don't need to get it so narrow that the tube drops free.

Afterwards look down through the spring and identify any coils that might have rotated out of alignment with their neighbors and bring them back into alignment.

Assembling a magazine

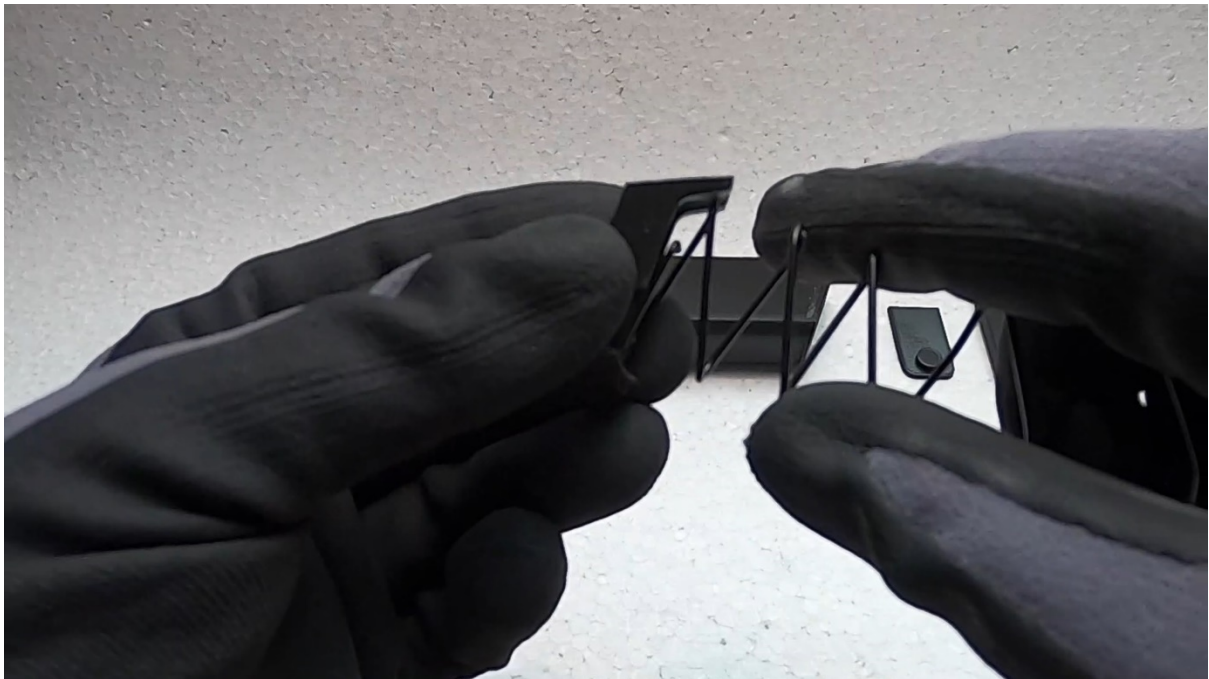
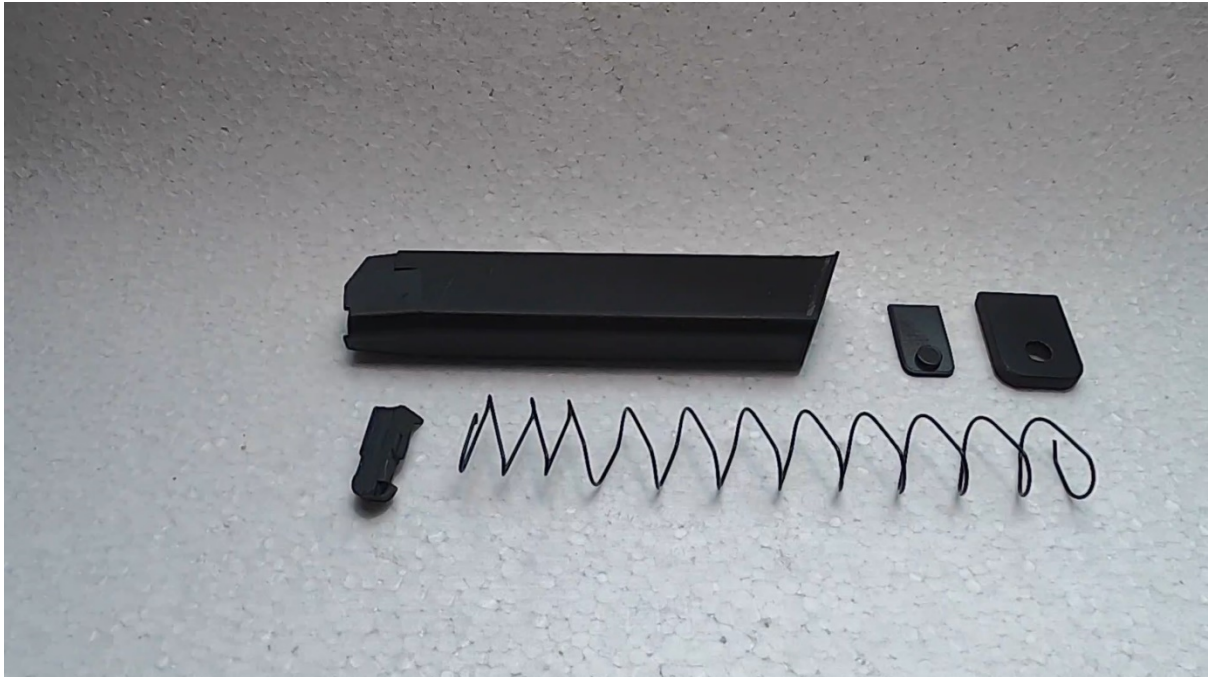

Gather a magazine body, a floor plate, a locking tab, a follower and the modified magazine spring.

Clip the follower on top of the narrow end of the magazine spring in the correct orientation.

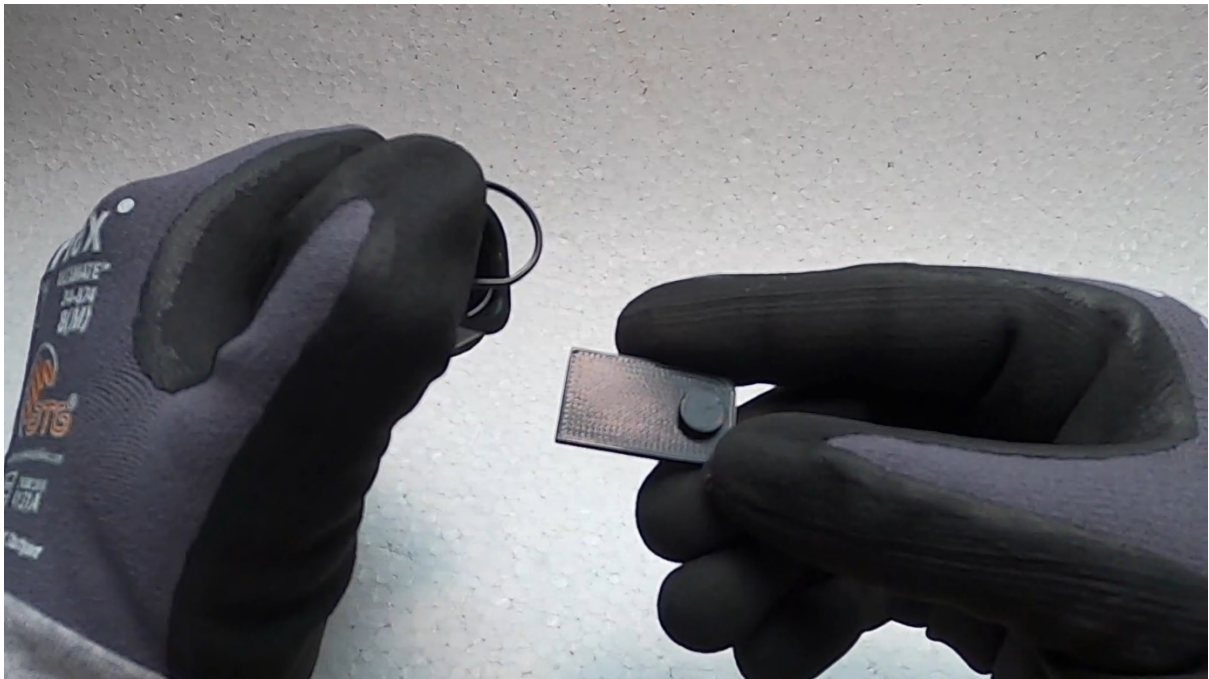
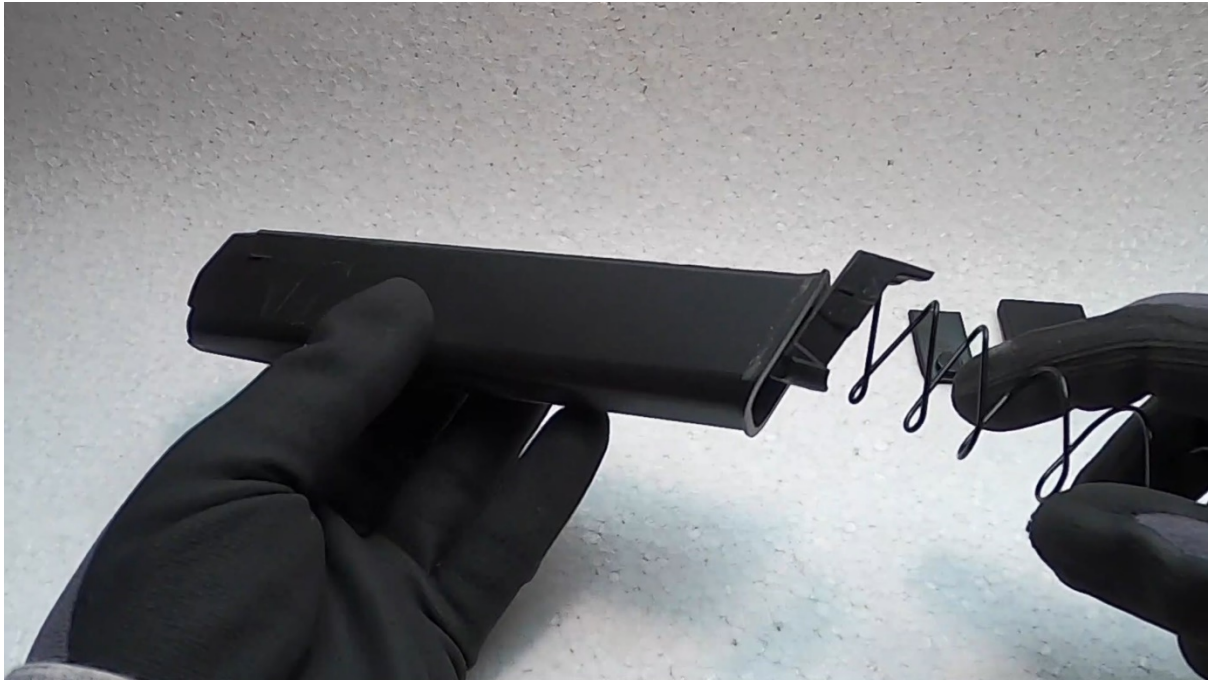

Insert the magazine spring with the follower on top into the magazine body.

While keeping the magazine spring inside the magazine body push the locking tab onto the bottom of the magazine spring so that it ends up being flush with the bottom of the magazine body.



While pushing the magazine locking tab inside the magazine body against the magazine spring pressure, slide the magazine floor plate over the front on the bottom of the magazine body and have the round feature of the locking tab lock itself into the hole of the magazine floor plate.

Assembling the lower



Get the 4mm drill bit and hand ream the hole on the lower receiver that will hold the hammer pin. (Hole near magwell) Ream only as much as needed so the drill bit can go through. Do not ream any more than that, as this will cause issues.

DON'T REAM THE HOLE FOR THE TRIGGER PIN (OTHER HOLE) IF YOU CAN INSERT THE AR-15 TRIGGER PIN WITH SOME FORCE. THE FIT FOR THE TRIGGER PIN HOLE NEEDS TO BE TIGHT. A LOOSE TRIGGER PIN HOLE MAY CAUSE ACCIDENTAL BINARY FIRE.



Get the 9.5mm diameter drill bit and hand ream the hole on the lower receiver through which the fire selector will go into.

Ream only as much as needed so the drill bit can go through.

Do not ream any more than that, as this will cause issues.



Put the trigger spring onto the trigger the way you see in the picture. Insert the disconnecter spring into the trigger, if you haven't inserted it in there already. Push the disconnecter in the shown orientation into the trigger and hold it onto it against the pressure of the disconnecter spring.

Now hold that assembly together and insert it into the lower receiver. While pushing this assembly through the bottom hole for the trigger on the lower receiver, take your AR-15 trigger pin and push it through the lower receiver as well as the lined up trigger and the disconnecter hole in the trigger.

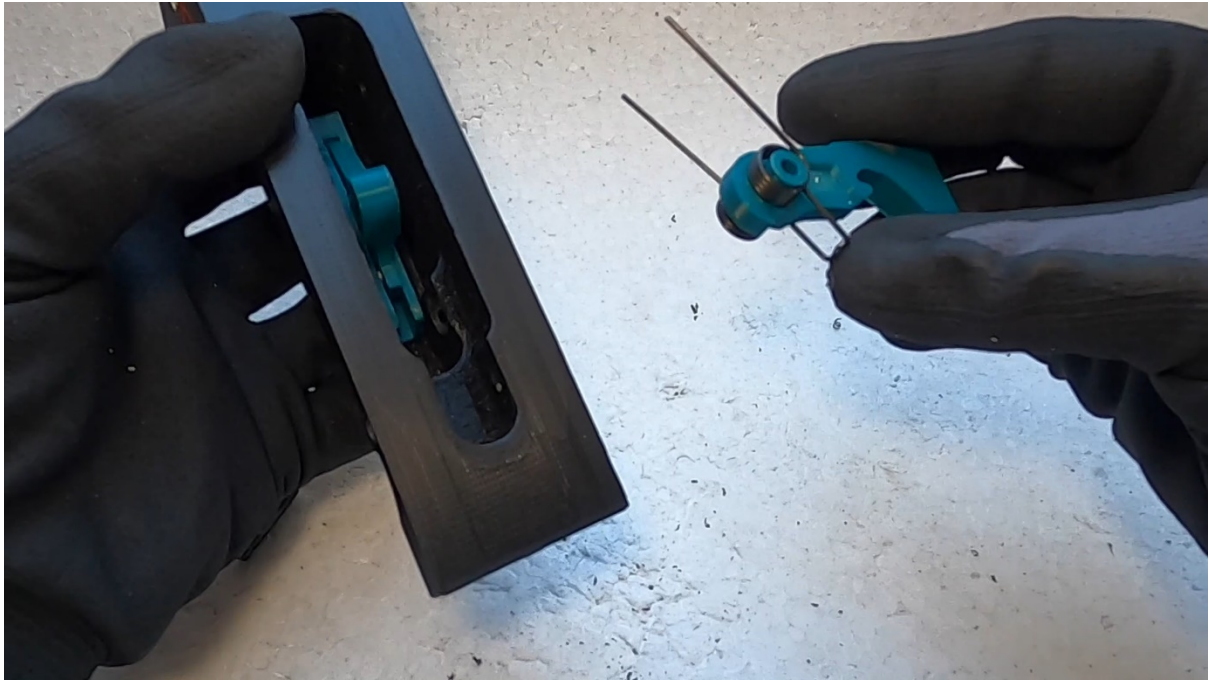

Put the hammer spring onto the hammer as shown in the upper picture. This will be challenging for you at first, but you will manage.

Now push with the spring legs leading against the studs on the trigger in the way shown on the picture.

You will have to fight against that spring pressure.

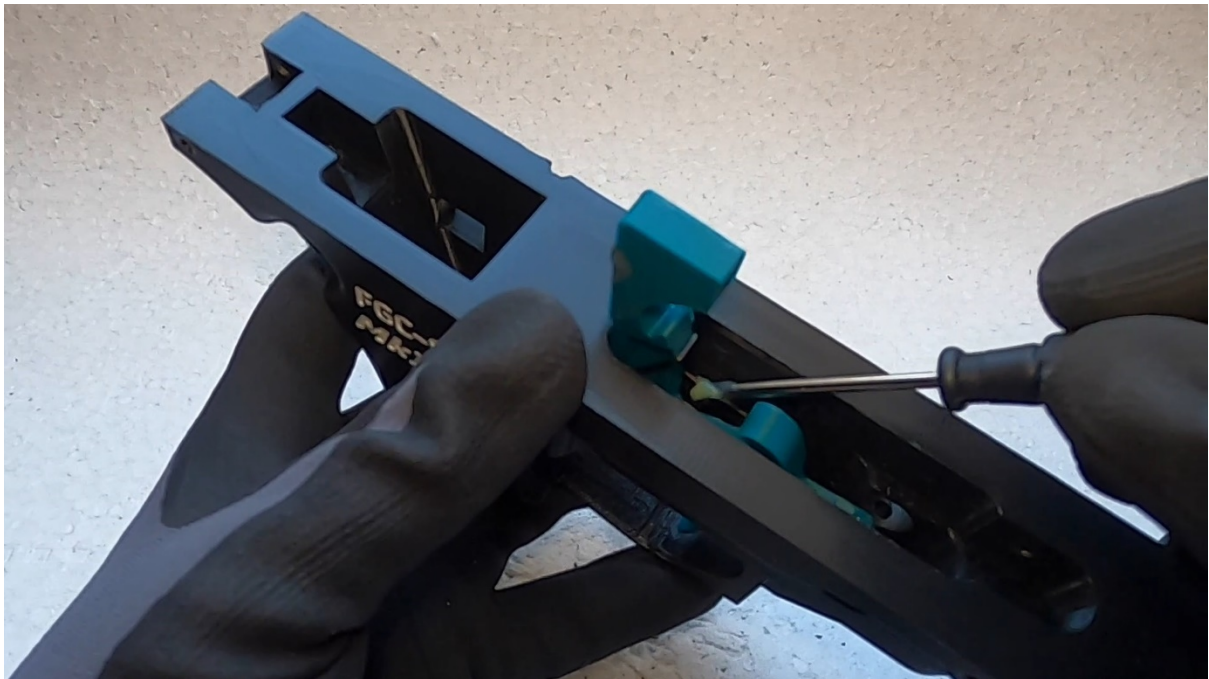

While holding the hammer in position against the spring pressure, take the 4mm diameter DIN pin and push it through the dedicated hole while trying to align the hammer.

With the hammer in the up position apply grease to the area where hammer and trigger touch each other.



Apply grease to the sear at the back of the hammer as seen in the picture as well as some grease onto the top sear surface of the trigger.

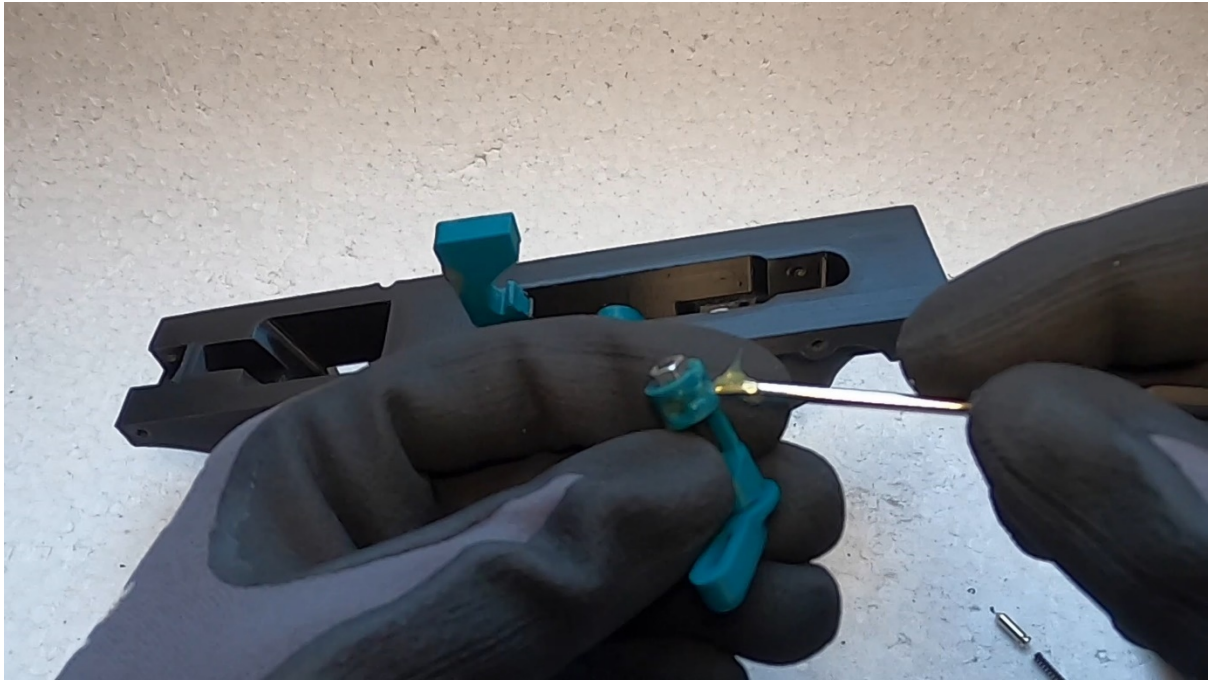

Take the fire selector assembly and apply grease to the detent cutout area as you can see in the picture.

Now take the fire selector and push it through from the left side of the lower receiver as you can see it, in the picture.



With the fire selector in the position you see in the picture, hold the lever in place and then at the same time put the fire selector detent with the sharp tip first inside the hole at the bottom side of the lower receiver near the safety selector indicators.



Take the fire selector detent spring and put it into the dedicated hole inside the top of the pistol grip.



While making sure the fire selector is in the position mentioned previously and the fire selector detent still inside the hole, push the pistol grip onto its mating surface and make sure the fire selector spring goes against the bottom of the fire selector detent.

As you push against the spring pressure hold the pistol grip in place and use the Socket Head Screw M6,25mm along with the External-Tooth Lock Washer M6 DIN 6797 to screw the pistol grip into the lower receiver. After having done this, you may put the pistol grip lid into the bottom of the pistol grip in the case that you went with the 3D-printed pistol grip that is included with the FGC-9 MkII design.

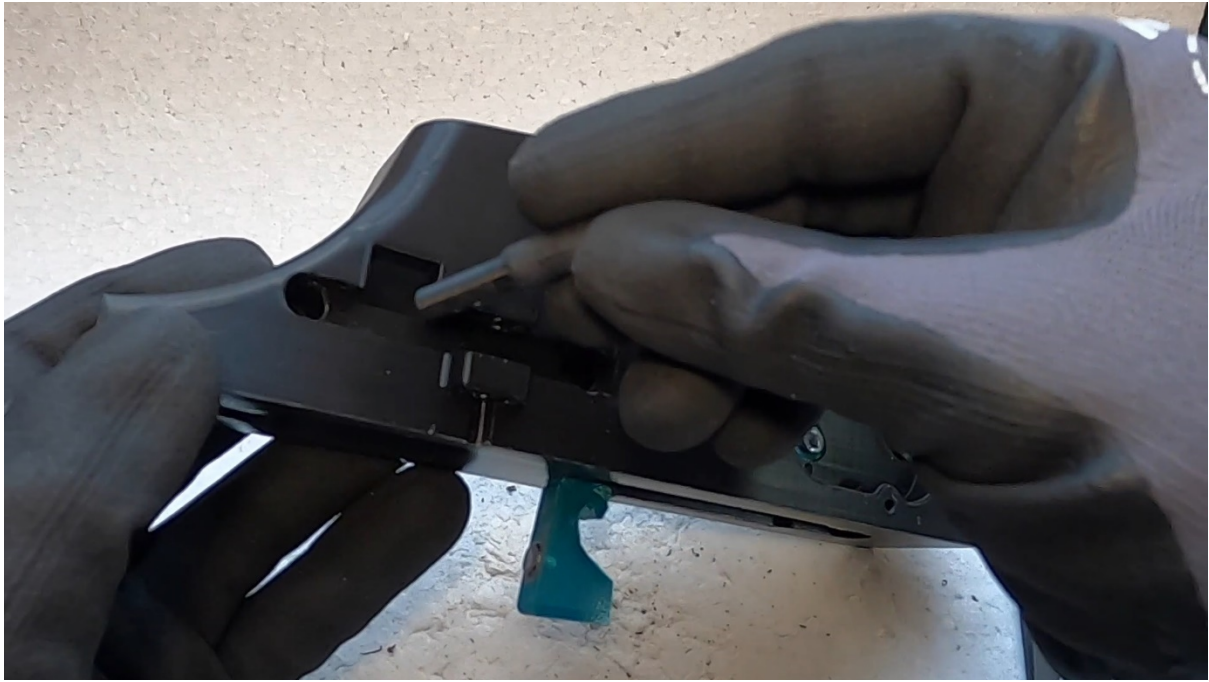

Insert the magazine catch button into the hole you see in upper picture.

Insert the magazine catch spring into the hole as you can see in the picture.

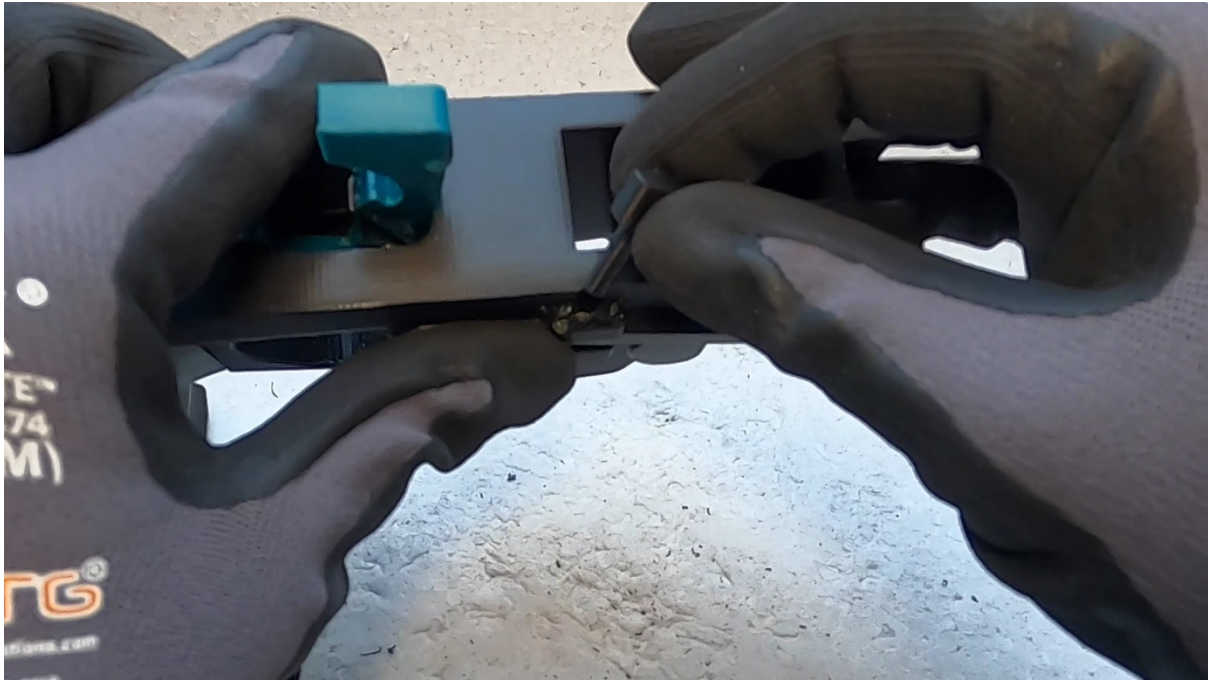

Take the magazine catch bar and push it into its cavity against the spring pressure of the magazine catch spring and try to align the hole on the bar with the hole on the lower receiver.

Push the magazine catch pivot pin through it.

Now take the feed ramp and put it in the orientation you can see in the lower picture, into its dedicated square slot on the top of the lower receiver near the front side.

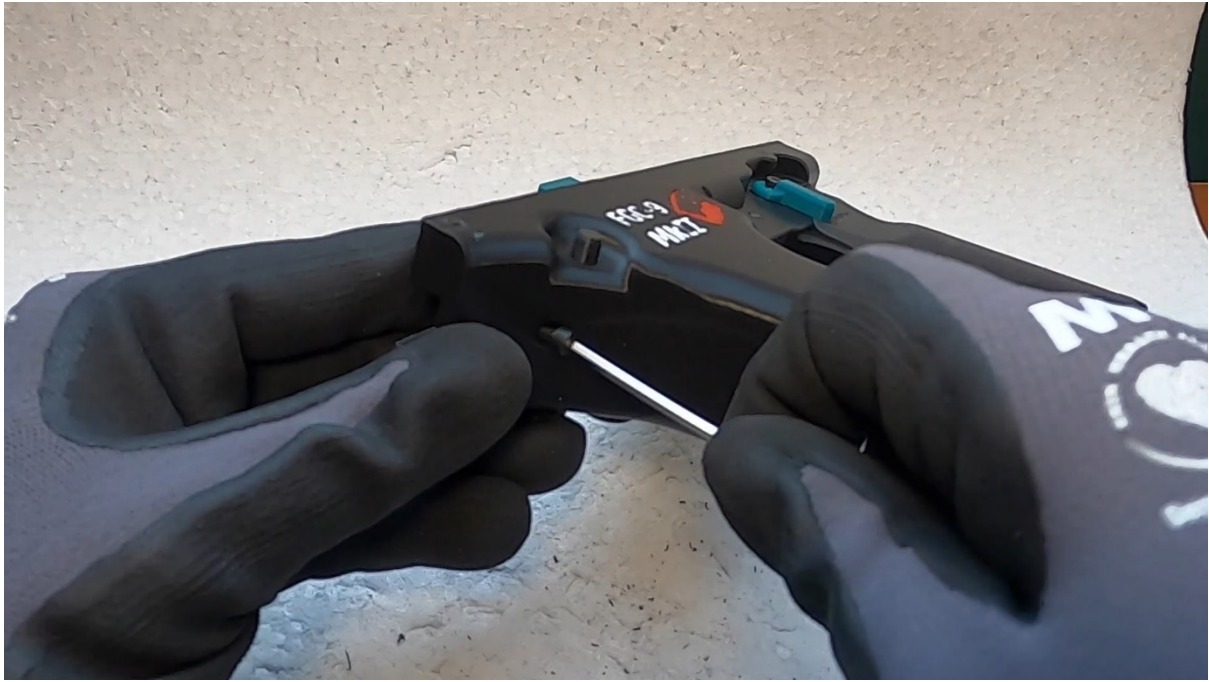

While pushing down on the feed ramp as much as possible from the top, use the Socket Head Screw M3,12mm to screw the feed ramp into place with the appropriate Allen key.

It is absolutely important that you pushed as much as you can from the top while screwing in the feed ramp to make sure that the the flat side on the top side of the feed ramp does not stick put past the top surface of the lower receiver.

Failing to do so will potentially prevent you from assembling the lower receiver to the upper receiver and then later on cause issues with the feeding of cartridges.

Assembling the barrel assembly

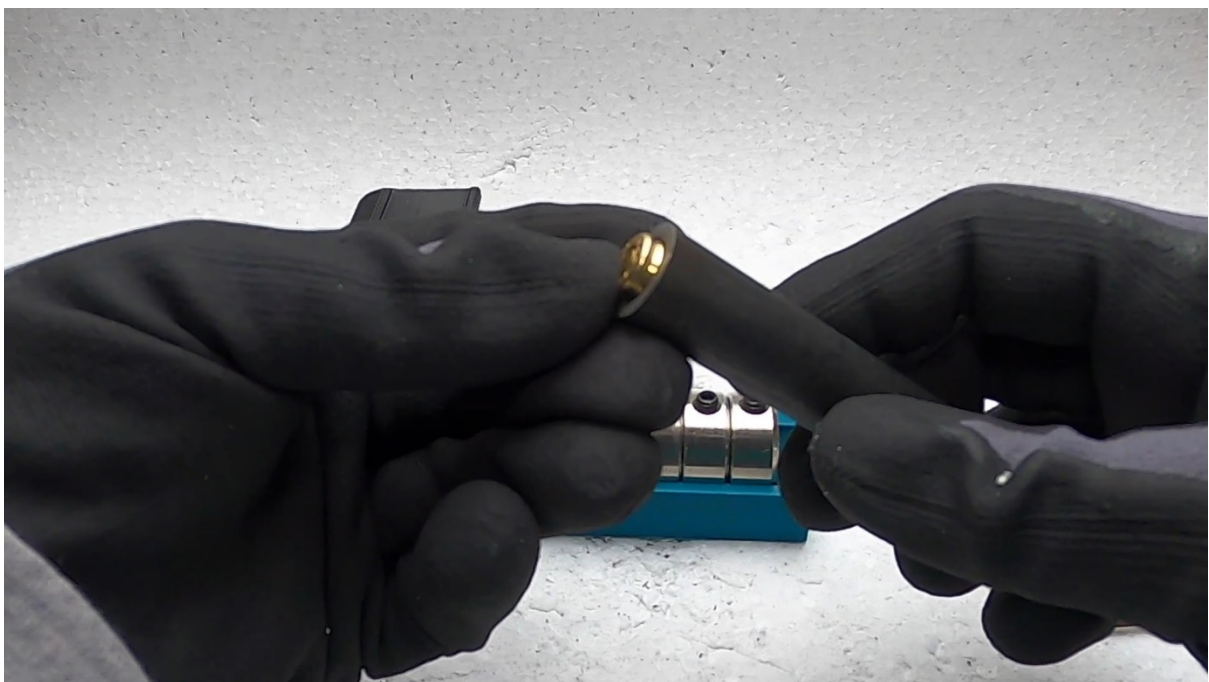
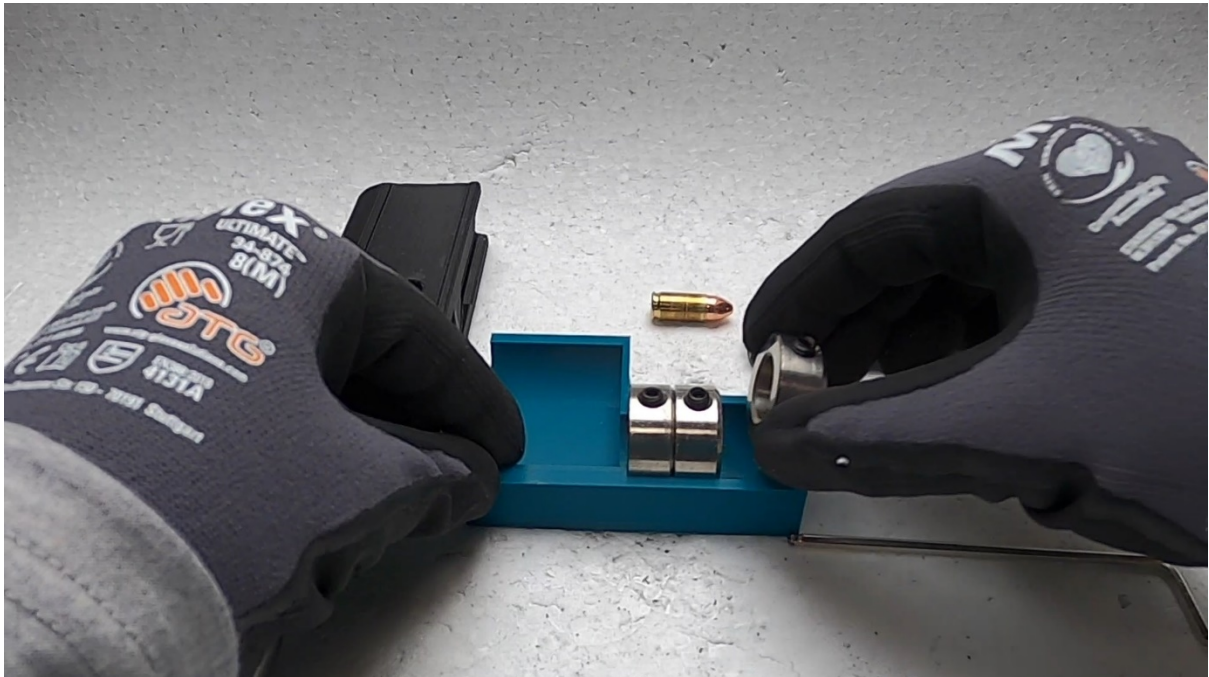

Get your headspacing jig and insert the three 16mm shaft collars into the shaft collar pocket.

Get your barrel and insert a case or cartridge into the chamber and make sure it is as deeply seated as possible. Make sure it does not back out.

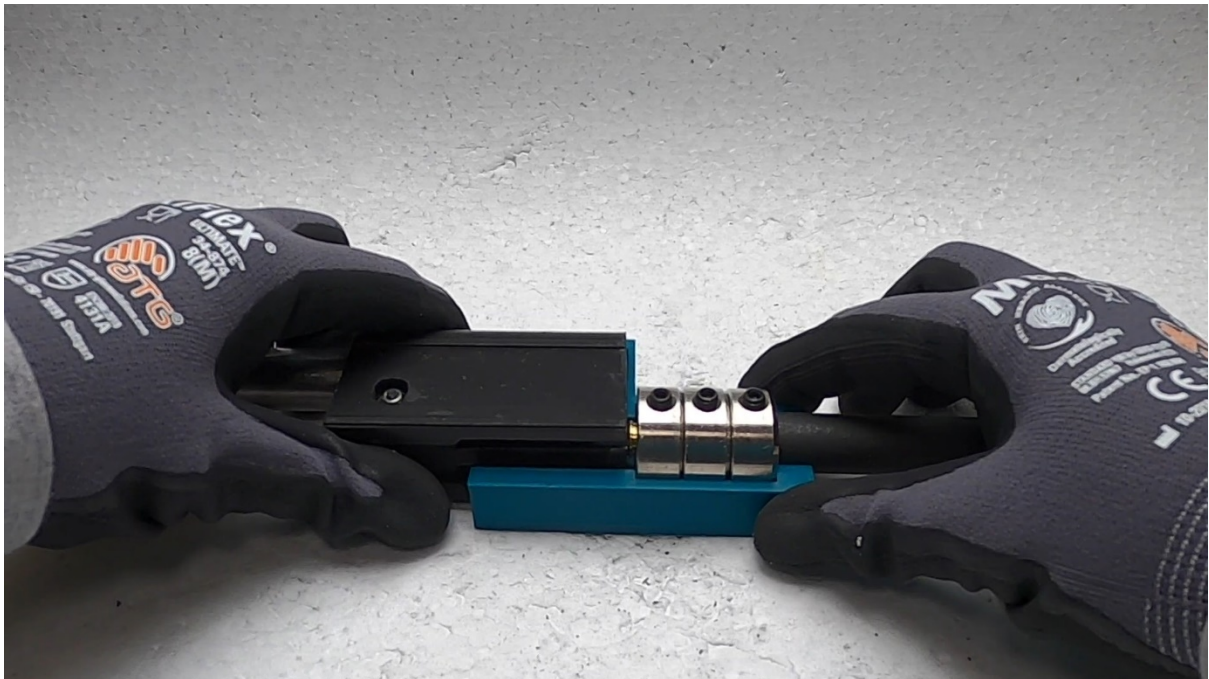
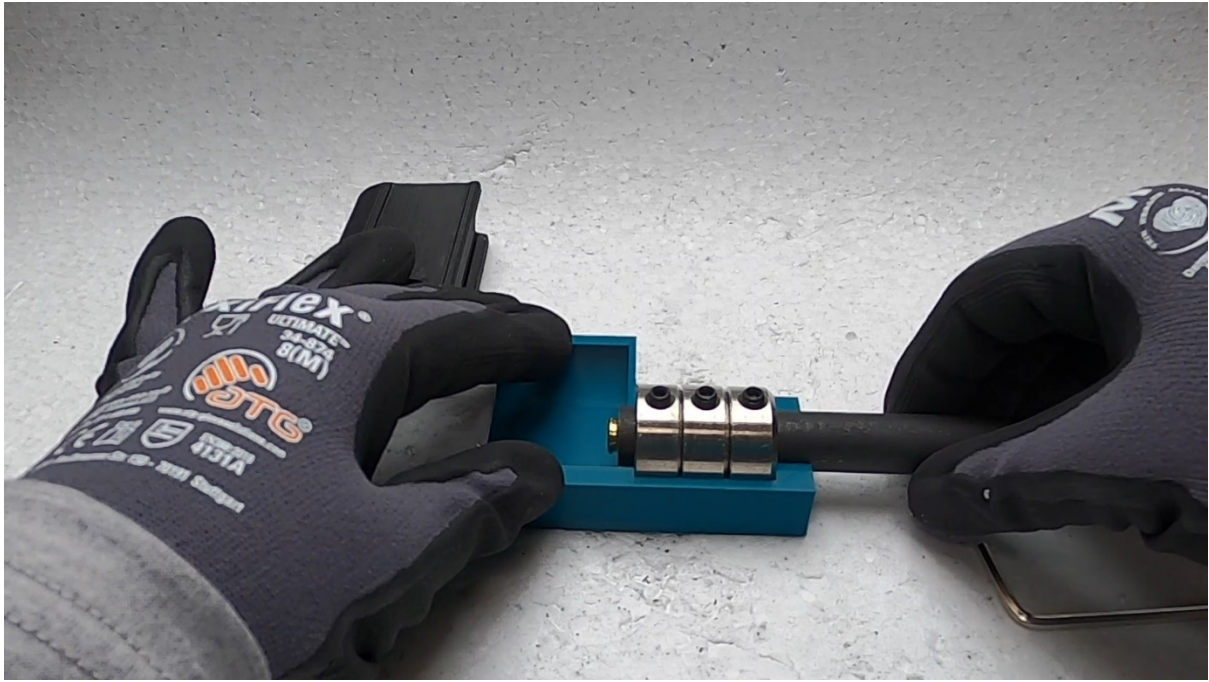

Insert the barrel through the shaft collars from the right and let it stick out into the main cavity on the left side as you can see in the picture.

You will then take your bolt assembly and slowly and carefully move it into the cavity until the bolt face makes contact with the inside of the cavity wall. Be sure to do this as slowly and meticulously as possible as to not move the case/cartridge and thus barrel further than it was than at the exact moment when the bolt face touched / kissed the end of the inside of the cavity.

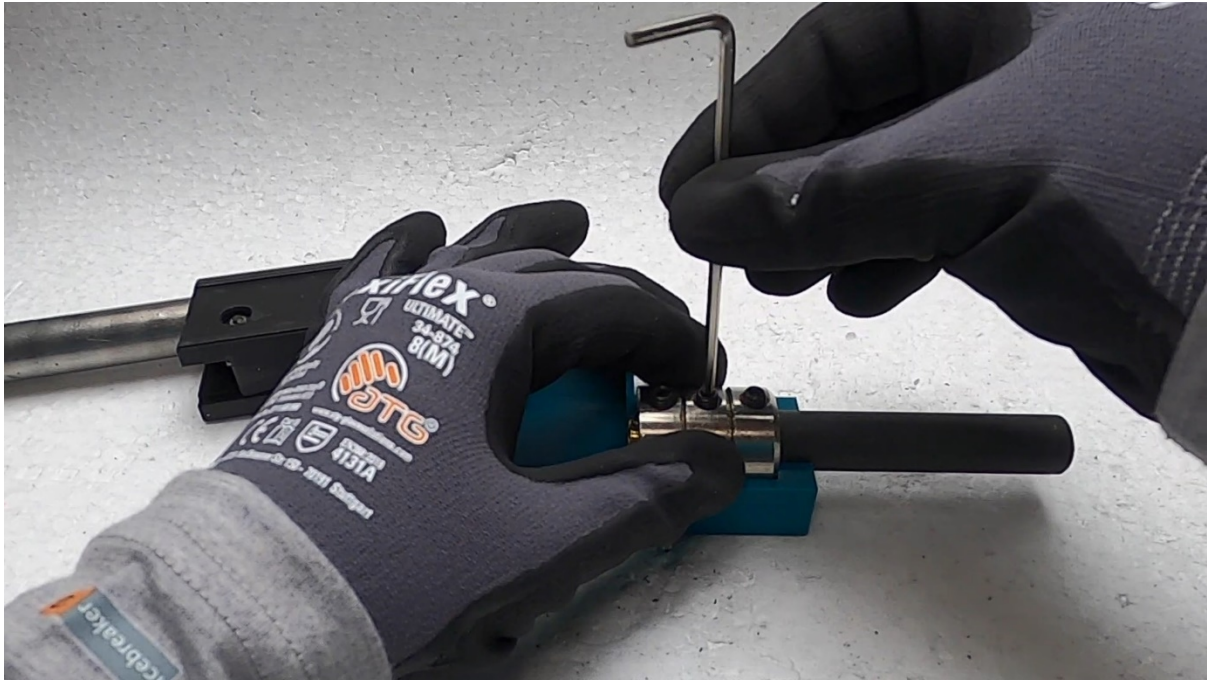

Being extremely careful that you don't move anything apart from the bolt assembly, slide the bolt assembly out of the setup and immediately tighten the grub screw of the center shaft collar.

Then go ahead and tighten the first and third shaft collar to the same degree. Make sure you press the first and third shaft collar as close to the center shaft collar as possible so that the stack maintains its shortest possible length. Once the center shaft collar can not be moved anymore you then can go ahead and lift the barrel assembly out of the jig and tighten the grub screws as hard as you can. The barrel assembly is now assembled properly and your headspacing should be properly set.

Assembling the upper



Take the ejector and try to get it into its designated slot on the inside of the upper receiver. Make sure to put it in there in the shown orientation.



Align the hole on the ejector with the hole on the underside of the ejector cavity and screw the Socket Head Screw M3,16mm into place with the appropriate Allen key.

MAKE ABSOLUTELY SURE THAT YOU ARE USING THE 16mm LONG M3 SOCKET SCREW. If you accidentally screw in the screw for the bolt assembly for example into this place, you will damage the upper receiver.

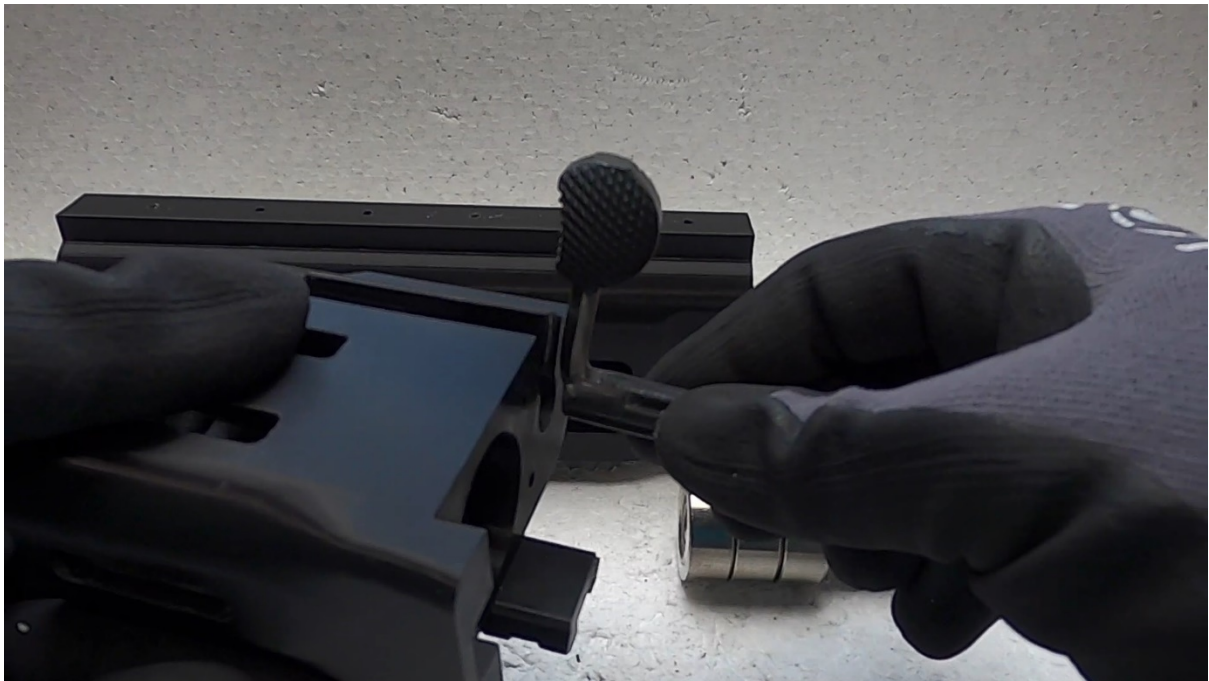

Having made sure you screwed the ejector into place and that the ejector is freely pivoting inside the upper receiver, get your charging handle and insert it into the barrel retainer in the orientation shown in the bottom picture.

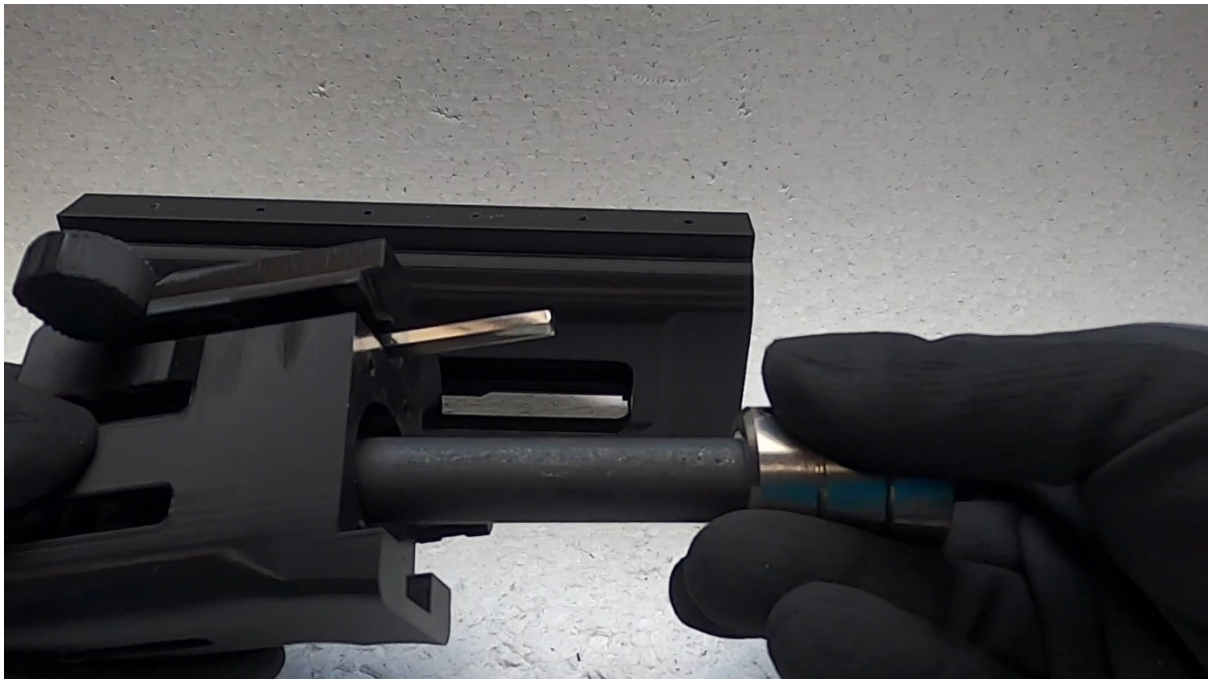

If you have silicone spray on hand, spray silicone spray into the charging handle cavity on the barrel retainer.

Afterwards, get your barrel assembly and with the muzzle side first push it through the barrel retainer from the shaft collar pocket side.

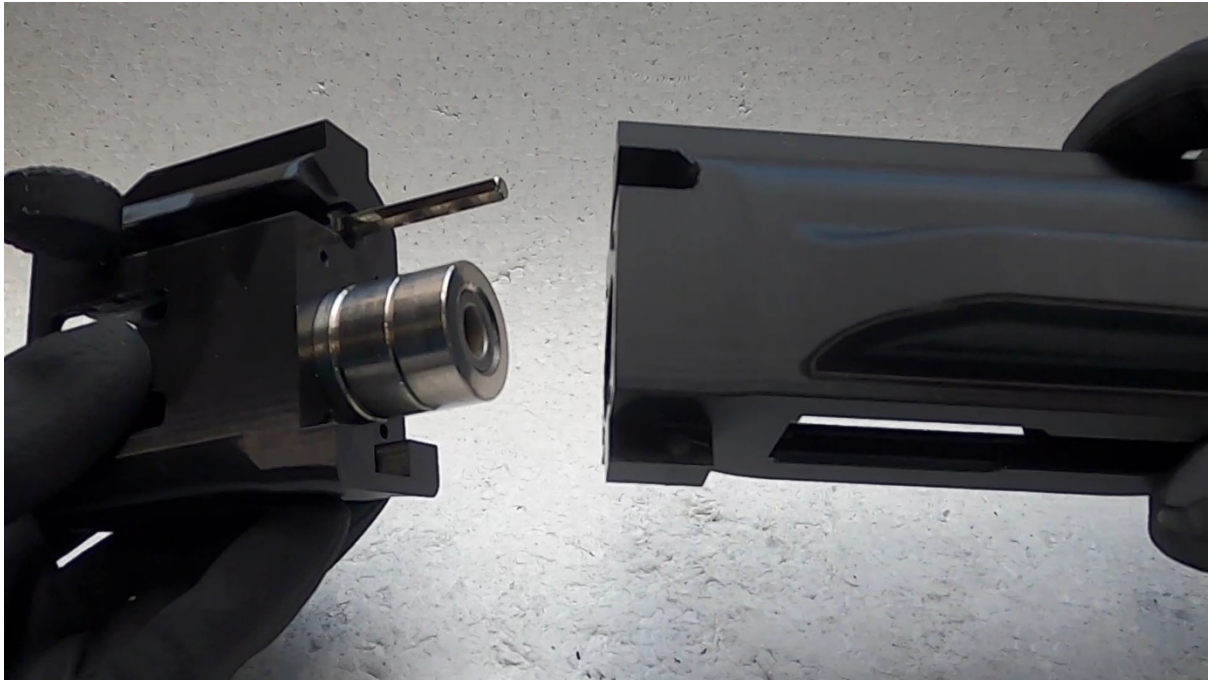

Making sure that the charging handle is in place in the correct orientation and the barrel assembly sits inside its pocket in the barrel retainer, push the upper receiver onto the barrel retainer.

You may now take each of your 40mm M3 screws with each having a M3 washer on them and use them to screw the barrel retainer onto the upper receiver. Screw each screw lightly at first, then go clockwise or in a cross-diagonal manner screwing the screws tighter in an alternating manner. You may need to change extensions on your socket tools to reach all the way down into the barrel retainer cavity.



You might be unfortunate to only have access to socket tools that are too wide and thus won't be able to reach all the way down, in that case try to look for alternate socket wrench tools until you find something that lets you screw down the screws firmly into place.



Take your top rail and place it on top of the upper receiver in the orientation shown in the upper picture.

Now take seven of your 16mm M3 socket screws and screw the top rail into place with the appropriate Allen key.

Assembling the stock assembly



Insert the secondary buffer spring into its dedicated slot at the bottom of the buffer tube. When you printed the buffer tube a piece of support that looks like a rod should have been left. Use that rod piece to push the secondary buffer spring firmly into place at the bottom of the buffer tube. To make sure it is firmly in place, try to shake out the buffer spring.

If it doesn't fall out while shaking the buffer tube violently, it is in place adequately. If the secondary buffer spring falls out while shaking, take your pliers and try to expand the last coil on the secondary buffer spring. Now you will be able to firmly re-insert it into the buffer tube and it should stay in place for sure.



Slide the stock over the buffer tube making sure that the L shaped feature of the stock points down into the direction of the hole at the end of the buffer tube. Your goal is to align the hole on the buffer tube end with the hole that goes through the main section of the stock.

You should now be able to use the 30mm long Socket Head Screw M4 to install the stock onto the buffer tube.



After making sure that the M4 screw is properly in place as you can see from the top picture, take the butt plate and hold it against the end of the stock.



Take your last two 16mm M3 socket screws and install the butt plate onto the stock.

Main assembly



If you have silicone spray on hand, spray it onto the side and bottom surface of the bolt assembly. Now push the bolt assembly WITHOUT FIRING PIN INSTALLED, into the upper receiver.

There is a trick to inserting the bolt assembly. You will have to go through the underside of the upper receiver with your fingers and push the ejector against the inside of the upper receiver as you push the bolt assembly in. During occasions when you have your lower attached the upper, additionally you need to depress the hammer with your finger, by going through the ejection port.



Pull the bolt assembly slightly out of the upper receiver, as to make sure that you have room near the chamber area of the upper receiver. This will make sure you can mate the lower receiver against the upper receiver and prevent the feed ramp from bumping into the bottom of the bolt.

After you have pushed the lower receiver up against the bottom of the upper receiver, you should be able to slide the lower receiver towards the front and this should let you properly mate the upper to the lower. If you encounter issues during this process, you will realize that the feed ramp will be the main culprit. You will have to make sure you get the bolt out of the way first and do the aforementioned maneuver to butt the lower up against the main portion of the upper receiver first, then slide the lower receiver forward and then finally align the holes on the lugs of the upper receiver with the holes on the ends of the lower receiver.



Once you were able to align the holes, you can insert your last two 40mm M3 screws, along with M3 washers from one side of the lower receiver and then secure them on the other side with M3 nuts.

Once the lower is securely attached to the upper you can push the main buffer spring onto the long bolt piece towards the inside of the upper receiver.



Now push the stock assembly against the back end of the main assembly and secure it with the 4x 20mm M3 hex head screws making sure you include 4x M3 washers.



Make sure you push the stock assembly firmly against the backside of the main assembly while securing each screw. Not doing so may cause unnecessary stress to the first two or three screws as you are securing the last ones. So make sure after you started screwing in the first screw, to constantly hold the stock assembly against the main assembly while screwing in the remaining screws.

Even though it may seem like you have completely assembled your FGC-9, it is still not ready to be fired. Continue the next steps on the following pages to complete your FGC-9 build to be able to safely test-fire!

Testing cartridge feeding

To make sure that your firearm functions properly when it comes to the bolt picking up cartridges from the magazine and putting them into the chamber each time the bolt comes forward, you need to test this before even thinking about firing your FGC-9 with live ammo.

Follow the following steps to complete this test and see whether your FGC-9 is functioning correctly.

If any of the 10 cartridges fail to properly go into chamber, you need to fix the causing issues before you fire real ammo, otherwise your FGC-9 won't function reliably.

BEFORE YOU CONTINUE: MAKE SURE YOUR FGC-9 HAS NO FIRING PIN IN THE BOLT ASSEMBLY !



Lock your bolt back with your charging handle.



Take your magazine and load 10x cartridges into it.



Insert your magazine into your FGC-9.



Look into the ejection port to ensure that the magazine is properly in place with the cartridge sitting properly at the top of the magazine.



With a quick motion slap the charging handle.



Look at the right side of your FGC-9 and see whether the bolt is closed and you don't see the cartridge being wedged. If you see that that bolt is open/the cartridge is not properly in chamber, you need to refer to the troubleshooting guide, to fix your firearm not feeding reliably.

If the bolt is closed and all you can see through your ejection port is the side of your bolt, you can continue with the next steps.

Remove the magazine now.



Lock your bolt open by using the charging handle, make sure you keep the muzzle pointed downwards while doing this.

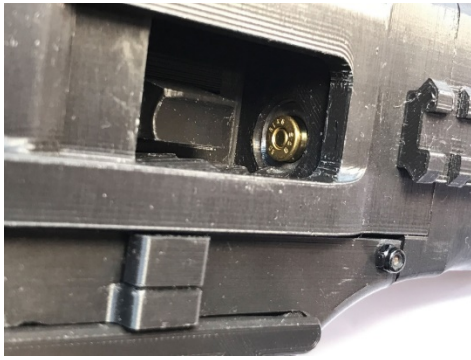

Now check whether the cartridge sits properly inside the chamber. Tip your FGC-9 upwards and interact with the charging handle / bolt assembly / ejector to have the cartridge fall out of the chamber.

If your chamber is made well, your cartridge should fall out with little manipulation.

If your chamber was made less than ideal, you need to use a small slot screwdriver for example, to aid you in getting the cartridge out of the chamber.

If you need a significant amount of force to do this, it is a sign that your chamber has not been made well and you should consider looking at the trouble shooting guide of this guide and/or the ECM-rifling guide to improve your chamber.



After you have removed the cartridge, repeat the last few steps for the rest of your 9x cartridges still in your magazine.

Only after you have made sure that your FGC-9 has reliably put each of the 10x cartridges successfully into the chamber, you should consider going ahead with the completion of your FGC-9, let alone live firing it.

Adjusting the firing pin protrusion



Take your firing pin spring stock (6mm OD, 1mm Wire, 25mm \pm 1 Factory Length) and cut off a 7.5mm section from it.



Use wire cutters. Wear protective glasses or have a rag over the cutters while cutting, to prevent the spring from flying off.



Afterwards make sure that the spring is about 7.5mm long.



Use a rotary tool or a file to grind the side flat you just cut.



Make sure the end is as flat as possible.



Put your spring over your firing pin and insert the pin into your bolt.



Use a 3mm pin punch for example or any tool that fits into the back opening of the bolt, to push the firing pin in.



Push in as hard as possible.

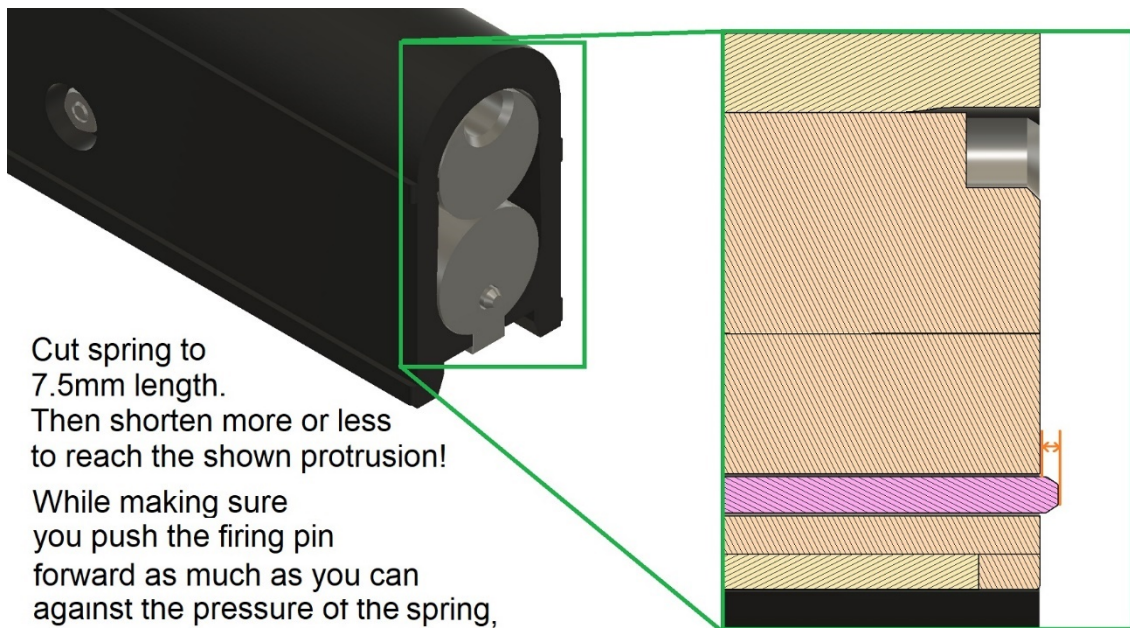

Cut spring to 7.5mm length. Then shorten more or less to reach the shown protrusion! While making sure you push the firing pin forward as much as you can against the pressure of the spring,

Reach a protrusion distance of: **1.5mm \pm 0.25mm**

You need to measure how much the tip of your firing pin sticks out while doing this. The tip needs to stick out 1.5mm \pm 0.25. So between 1.25mm – 1.75mm



Use the depth measuring rod at the end of your digital caliper to measure how far the tip sticks out from the metal portion of the bolt face.



Your goal is to get the tip to stick out 1.25 – 1.75mm.

If the tip sticks out less, try to shorten the firing pin spring, by cutting off a quarter coil off it. Don't forget to grind the end of the spring flat after cutting.

If it sticks out more than 1.75mm, you need to cut a longer spring from your spring stock.

Final bolt assembly

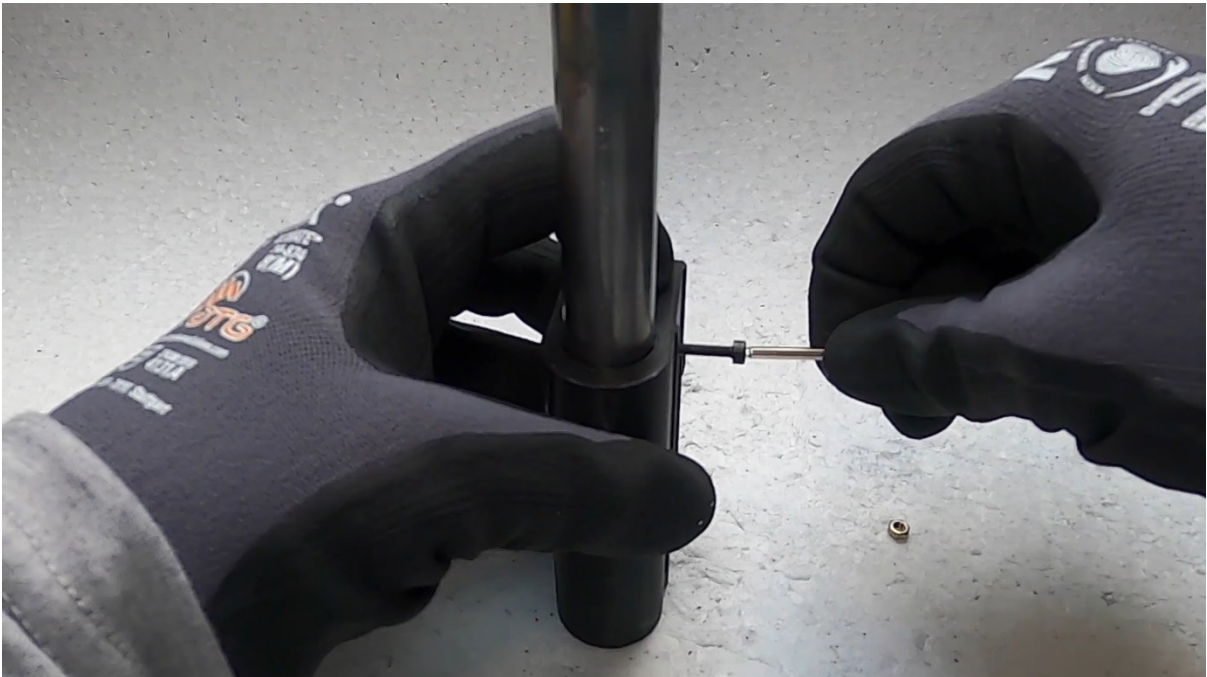
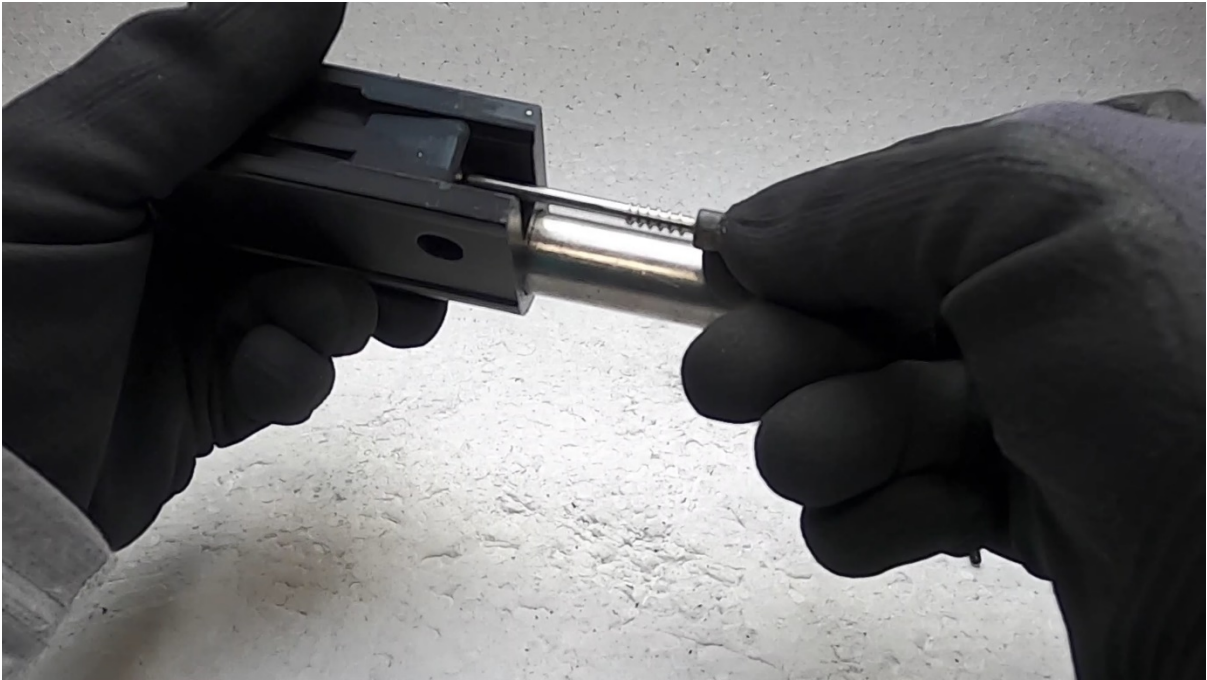

After you have completed the firing pin protrusion adjustment, insert the firing pin with the properly made spring on it, into the bolt.

While making sure that the firing pin and spring do not fall out, tip the bolt with the bolt face down and push against the back of the firing pin with your finger and insert the 20mm M3 socket head screw into the smaller hole on the side of the bolt. Use the appropriate hex key tool to screw the socket head screw in as deep as possible.



Get your LOCTITE fluid/glue now and apply it to the threads of the screw that are sticking out, as well as on the inside of a M3 nut. Now screw the nut onto the screw properly with your socket tool while keeping the screw in place with the Allen key/appropriate hex bit tool.

If you don't apply Loctite and don't tighten the nut properly, it may lead to the screw backing out during operation and cause severe issues, up to severe damage to the printed parts.

Now go ahead and assemble your FGC-9 MkII according to the previous instructions, but this time with the firing pin included.

Test firing and maintenance

Primer test

To make sure your firing mechanism works well without having to fire live ammo, you can fire empty cases with live primers.

If you don't have empty cases and live primers to assemble, you can also take apart cartridges with a bullet puller, they are available on Ebay, Amazon and Aliexpress. Make absolutely sure you have NO BULLET or POWDER in your cases. Take 10x primed cases and fire them. Scrunch up some kitchen towel paper into a ball and hold it against the muzzle when you fire, that way you will significantly muffle the noise.

Make sure all 10 out of 10 primers fire. Clean your barrel afterwards! If any of them didn't fire, you need to investigate whether you might need to shorten your firing pin spring or check for any other causes for your firing mechanism not being able to reliably set off primers.



Empty Case with no Bullet!



Only primer! No bullet or powder

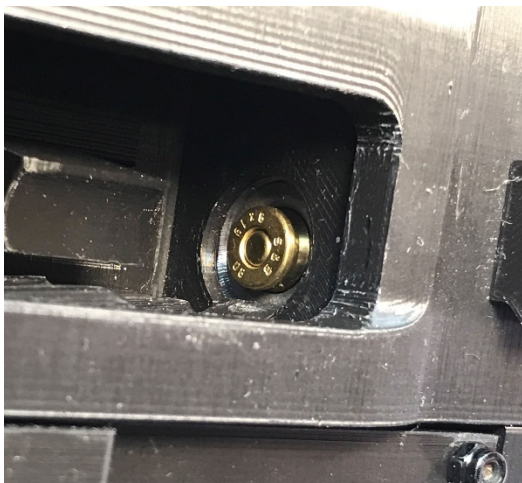

Insert manually into chamber



Pressing paper towels against muzzle to muffle the sound

Where and into what to test fire

One of the questions you will ask yourself once you have completed assembly is where you will fire the first dozen shots to test your FGC-9 build.

Ideally you have a patch of land, a building, garage or similar facility that is very far from inhabited areas.

If you do not have access to a remote firing area you can use a basement.

The next question will be what you will shoot into.

This becomes especially tricky when firing in a basement.

One needs to fire into a so called bullet trap in that case.

A portable and easy to build solution is the following, a video of one being used is included in the media folder.

Take a 60-liter plastic barrel and fill it with around 25kg of rubber mulch. Before the rubber mulch is poured into the barrel you can JB weld a 5mm+ thick steel disc that has the appropriate diameter down at the bottom, inside the barrel, to guarantee that no pistol caliber projectile can leave the bullet trap. Use a plastic barrel that has a plastic lid so that you can simply use strips of electrical tape to cover the bullet hole entrances.

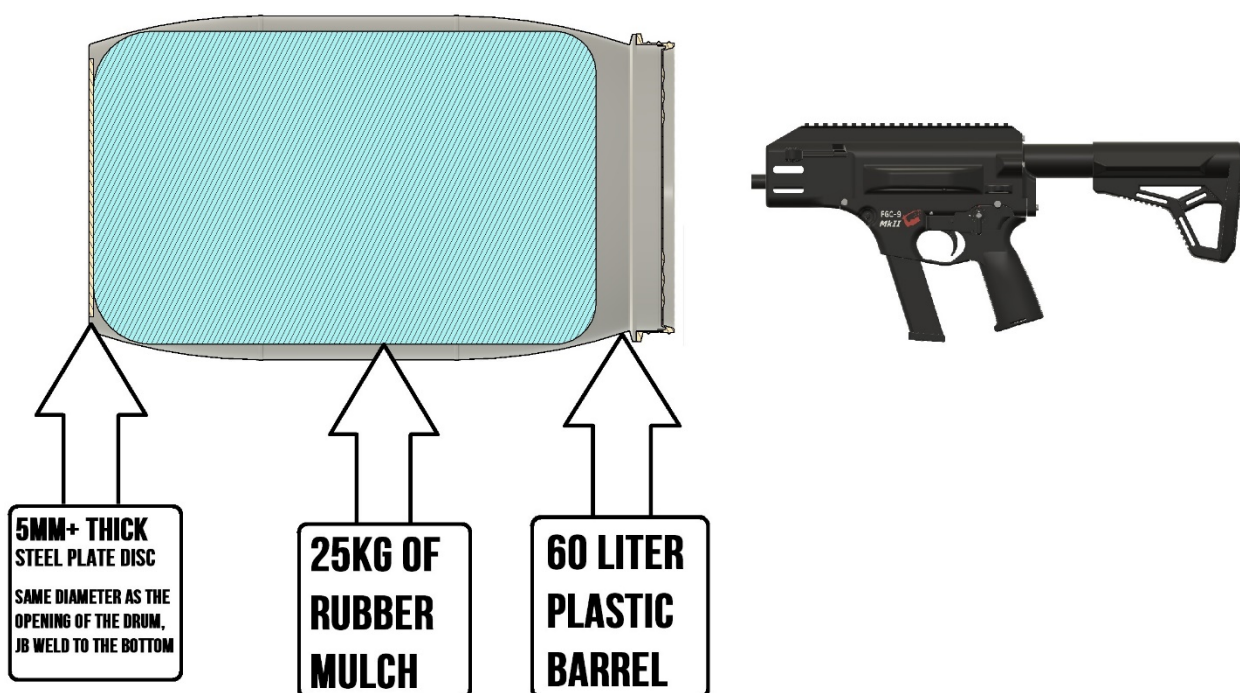

Test firing

For the first few test shots I recommend you wear gloves and ballistic eyewear or a welding helmet.

Only load one cartridge for the very first test shot.

Make sure to check that the bullet has left the FGC-9 barrel and check that there are no cracks or damage of any form on the gun after each of the first dozen shots. Inspect the firearm very closely after each shot. If you encounter any issues while testing the firearm or later down the line refer to the troubleshooting page.

Maintenance & Repairs

When you have spare time, brush the inside of your barrel with an appropriate brush from a cleaning kit and afterwards make sure that you have a film of gun oil(W18/S-758/S-761) inside the bore.

Use the occasion when cleaning your barrel bore, to spray some silicone spray into the inside of your firearm (mainly inside the upper receiver where the bolt rides on), so that the 3D-printed parts interact smoothly.

Keep dry-firing at a minimum as it can shorten the lifespan of the 3D-printed fire control group and firing pin spring. When dry-firing your FGC-9 MkII use 9x19mm snap caps to minimize wear.

Disassemble your FGC-9 MKII after every 200-300 rounds fired, to inspect the feeding ramp, bolt assembly and firing pin for any potential damages or deformation. Check that the firing pin spring still ensures the right protrusion distance(1.5mm +-0.25).

In the case that anything breaks on your FGC-9 MkII, first try to replace the part by 3D-printing it again.

If that is not possible because of time constraints or urgent need on the use of your FGC-9 MkII, you can resort to a technique called "PLA welding". Take some PLA filament string and have it act like soldering material and use your soldering iron to melt the new PLA filament into a crevice or crack on your broken part. This is a quick solution for repairing your 3D-printed parts. If you can wait a day before you need the part, resort to using JB-Weld as a filler material/glue for broken areas instead. Using JB-Weld will result in a stronger repair. If after it dries(12-24h) there is excess JB-WELD sand the repaired area first with rough, then fine grit sandpaper to ensure smooth function.

Note: This section of the guide will continue to be updated if new issues get uncovered over time by builders of the FGC-9 MkII.

Troubleshooting

Text and diagrams by IvanTheTroll

Check your primers to determine, whether your FGC-9 is functioning properly.



Good Primer Hits - Note the little to no bulging

Note these hits are a little off-center, this is about the furthest off-center the hits can be before the gun won't work!



Slightly Bulged Primers, these might be ok, but if the gun has extraction issues, consider these primers to be bulged and follow the steps.

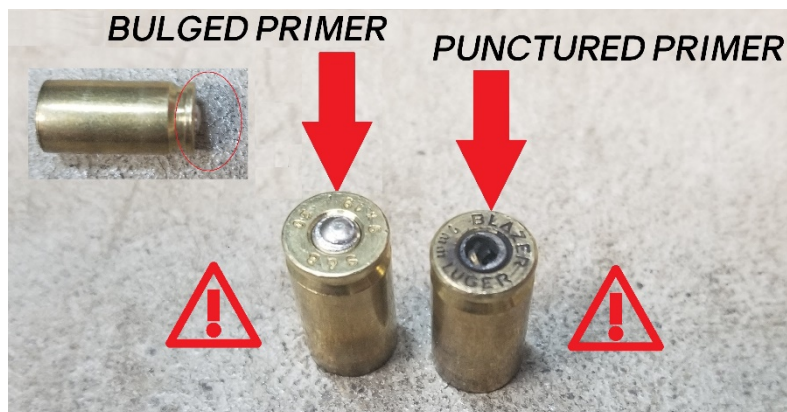

Dangerous degree of bulging or punctured/ruptured primers, refer to the diagrams to identify the causes of these issues.

When it comes to the issues the FGC-9 may face, two stand out as most common:

Failures to extract (the fired casing does not leave the chamber)

Issues with the firing pin (the primer on the cartridge is hit but does not ignite, or the firing pin is poking holes all the way through primers)

These steps will walk you through the tips and tricks that have been shown to help alleviate or completely solve these issues.

Troubleshooting Failures to Extract

The most common causes of FTEs(Failures to Extract) are:
a poorly cut/misshaped chamber and/or an issue with headspacing.

The frustrating part about solving this issue is that it's hard to be sure exactly which part (the chamber or headspacing) is to blame for your FTEs.

Do note that these steps/instructions are meant for troubleshooting guns that are using barrels made via the ECM process –if you have these issues using a factory or reamed chamber, then your issue might be due to your firing pin.

Skip to the section about firing pin issues and follow those steps.

This flow diagram should help you identify what your issue might be.

Based on which answer you arrive at in the flowchart, follow the instructions after the flowchart.

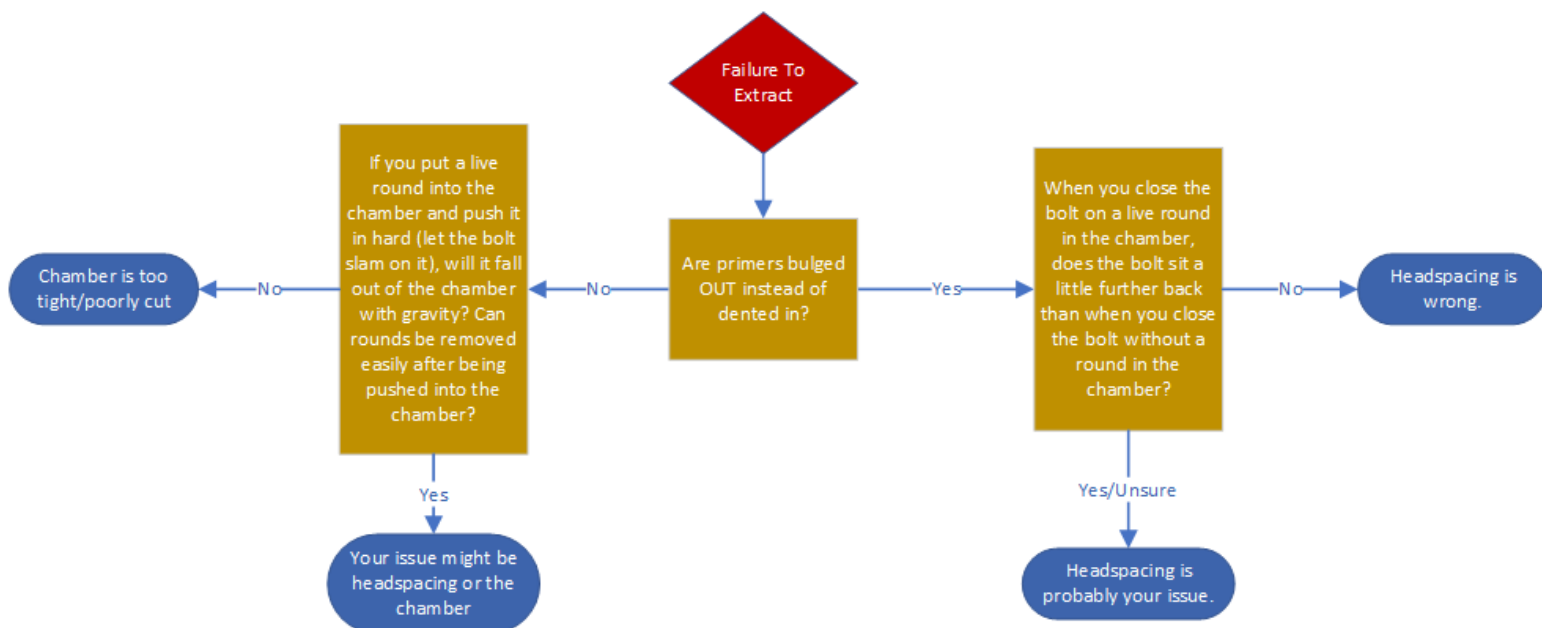

Chamber is too tight/poorly cut

First off –if you made your barrel following the ECM process and you didn't use a tapered chambering rod, understand that this issue is usually best resolved by using a tapered chambering rod.

Using a Ø9mm FLEX-HONE brush or a Ø10mm Chinese copy of it, to smoothen the inside of your chamber might already fix this issue.

If you didn't use the ECM process to make your barrel and the flowchart lead you here, there are two things that can be wrong with your chamber that can cause FTEs.

One is that the chamber itself being too tight –this can best be resolved by cutting for 10 more seconds on the chamber (assuming you used the ECM setup to make your barrel). The other thing is that your chamber seat is very curved/poorly defined. You will be able to tell which of these two things is happening by taking a live round and letting the bolt slam it into the chamber.(Put Fire selector to SAFE!)

Take the round out and look at it. If the round is shiny around the case mouth (where the bullet sits inside the case), then your chamber seat is poorly defined. If the case mouth looks good, then it's most likely that your chamber is just too tight (especially if anywhere on the case that isn't the case mouth is shiny).

If you determine that your chamber is just too tight, go back to your ECM setup and cut for 10 more seconds, then repeat the process of checking if the chamber is too tight. If you determine that your chamber seat is to blame, you probably cut your throat too wide during the ECM process (stick closer to the specs in the documentation next time). You will probably have to redo you barrel.

However, you can still try the troubleshooting tips in the “Headspacing is wrong” section if you would like to make absolutely certain it is your chamber that is the issue.

Your issue might be headspacing or the chamber

This is the worst spot to be in. I recommend you follow the steps from the next section first, and if that doesn't solve your issue, follow the steps in the section above this one. There's no good way to tell what's going wrong with your build, so you'll have to check both–however, the only time one of my builds ended up in this spot is when I had a proper chamber, but I had too little headspacing (read the next section to understand what this means).There is also a small chance your issue is your firing pin itself–refer to the “Firing Pin Troubleshooting” section below if you suspect this is the case.

Headspacing is wrong / Headspacing is your issue

This is probably the easiest issue to check/resolve. First, you'll need to understand what "headspacing" is. Headspacing refers to the distance between the face of the bolt and the rear end of the cartridge case. When speaking in terms of the FGC-9, LESS headspace means that the barrel is moving rearwards (towards the bolt), MORE headspace means the barrel is moving forwards (away from the bolt). Too little headspacing means that that bolt will ram a cartridge hard into the chamber, and it will be the cartridge itself in the chamber that stops the bolt. Too much headspacing means that the bolt won't actually be touching the rear end of the cartridge (or it will only barely be touching it) -this is what would cause bulged primers and could potentially be dangerous. Perfect headspacing is where the bolt will push the cartridge fully into the chamber and be resting against both the rear end of the cartridge AND the front wall of the upper receiver at the same time. The steps that follow describe how to help make sure your headspacing is where it is supposed to be.

On the FGC-9, you'll want your headspacing to be 0.00mm or less (meaning the bolt is resting against the rear end of the cartridge). However, you want your headspacing to be as close to 0.00mm as possible. You can establish this using the FGC-9 headspacing jig, but sometimes the headspace you set with that tool won't be quite perfect -you may still need to decrease headspace some.

Always start with the headspacing that you set on the jig, and after testing you can adjust from there.

The jig should never be causing too little headspace -if you suspect your issue is having too little headspace, reset your barrel using the jig and confirm it before moving the barrel forward.

NOTE: If you suspect you have too much headspacing (which can happen sometimes after using the jig), first check that the bolt is not getting stopped by the charging handle –when the bolt is all the way forward, the charging handle should NOT be touching the bolt face. The easy way to check this is to let the bolt and charging handle go all the way forward.

The charging handle should be able to move forward and backward a little without moving the bolt at all. If your charging handle is touching the bolt when the bolt is closed, you should grind down the long leg on your charging handle or drill the recess in the bolt face a little deeper.

Finally, if you've made sure that you started with a barrel that was set up on the headspacing jig, and that the charging handle is not touching the bolt face when the bolt is closed, you are ready to make a change to your headspace. Remove the barrel and shaft collar assembly. Make a visual note of where the barrel sits in relation to the shaft collars. Loosen the set screws on the shaft collars. Move the barrel rearward (towards where the bolt would be) relative to the shaft collars. If the shaft collars feel tight or the barrel won't move in them, make sure the set screws are loosened and tap the barrel with a hammer to move it.

After ensuring that the barrel has moved backward a little (when I say a little, I mean like 0.5mm –it only needs to move a tiny amount), tighten the shaft collars and reinstall the barrel. If primers are still getting bulged or you are still having FTEs, follow the flowchart again.

Firing Pin Troubleshooting

If you are experiencing light primer strikes, ruptured primers, or a failure to extract that you could not solve by following steps from the flowchart above, this section should be able to help you. First off –the FGC-9 runs best with about 1.5mm of firing pin extension. This value does not need to be very precise, and depending on your setup and ammo used, a firing pin with as little as 1.25mm of extension or as much as 1.75mm of extension might work fine. This section will help you fix issues with your firing pin.

Light Strikes

The most common cause for light primer strikes (the primer gets hit but the round doesn't go off) is that something is wrong with the firing pin. There is a small chance that the issue is headspacing (covered in the “Troubleshooting Failures to Extract (FTE)”, so be aware your barrel might be set too far forward in the shaft collars – but don't worry about changing this until you've made sure your firing pin is correctly set up. This flow diagram should help you identify what your issue might be. Based on which answer you arrive at in the flowchart, follow the instructions after the flowchart.

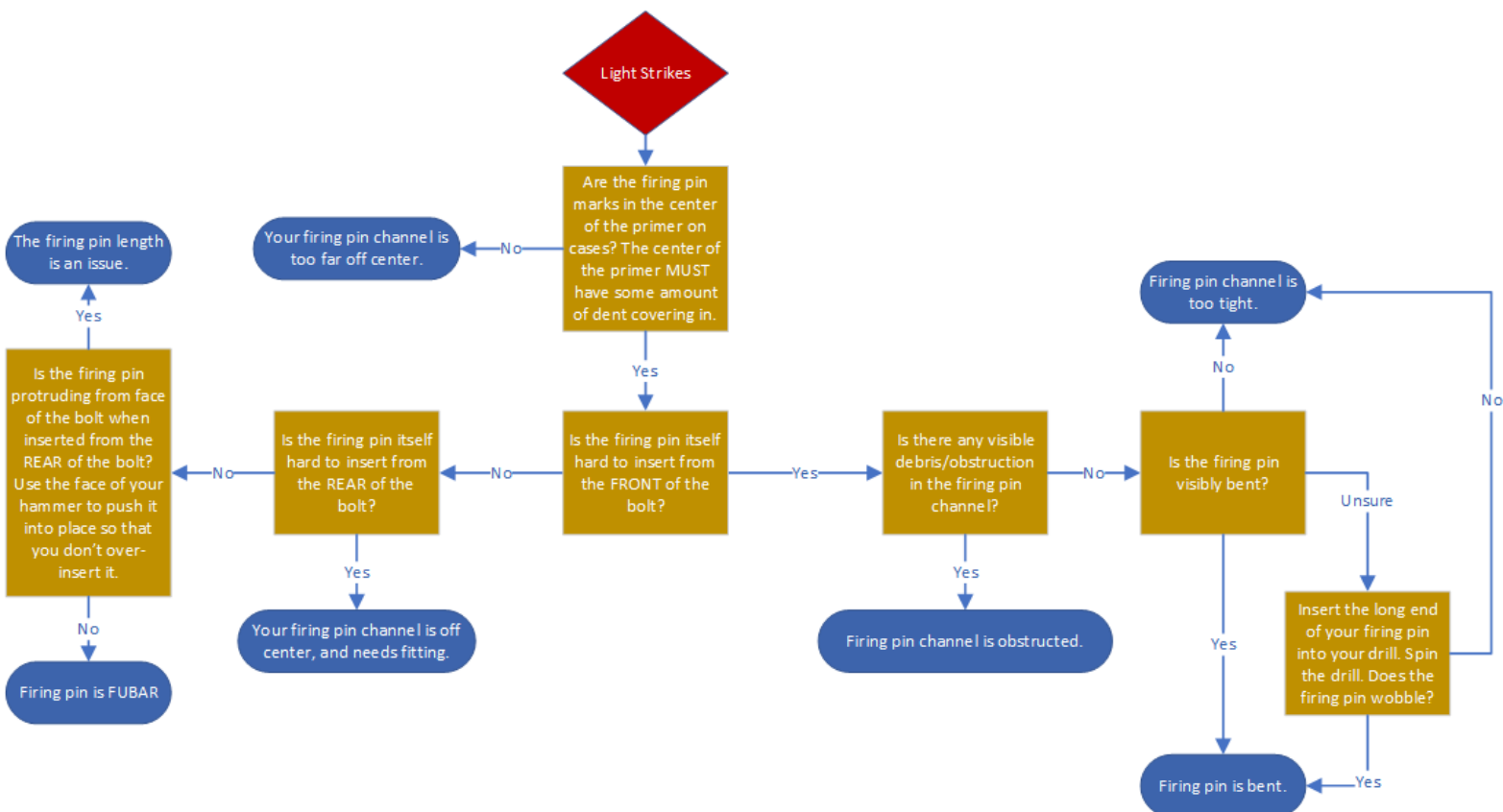

Your Firing Pin Channel is too far off Center

This is an annoying situation to be in. I've tried a huge number of things to try and fix this problem, but the only real solution is to make a new bolt. Pay very close attention to drilling the firing pin channel straight and ensure that the end of the lower bolt rod (the one with the firing pin channel) that you drilled into (the side facing up in the jig) is the side of the rod that faces forward whenever you mate your rods together.

The Firing pin Length is an Issue

First thing -check that your firing pin has the correct overall length(about 67.50mm).

If your firing pin is too long or too short, you can have light strikes. Go back to the firing pin documentation and ensure all the dimensions in the instructions line up with your firing pin. If either end of your firing pin is too long, you can trim it down slightly and check if that fixes your issue. If either end of your firing pin is too short, you will need to make a new firing pin and pay closer attention to the instructions -more often than not, it's getting the shaft collar in the right spot that is the issue.

Firing Pin is FUBAR

If you ended up here, your firing pin channel is either over 3mm off or your firing pin is totally wrong. Assuming your bolt isn't way off, then you need to redo your firing pin and slow down to read the documentation/get the measurements right.

Firing pin Channel is too Tight

Take the drill bit you used to drill out your firing pin channel. Using your drill, drill from the front of the bolt, spinning the drill at a high speed while moving it in and out of the hole. Apply a little silicone oil to the firing pin hole and test again.

Your Firing Pin Channel is off Center and Needs Fitting

So -your firing pin channel is off center, but at least some portion of your firing pin indent is still hitting the middle of the primer. You may be having inconsistent primer hits because your off-center firing pin channel is causing the shaft collar on the firing pin to drag against the internal cavity of the bolt housing. Inspect your firing pin/bolt housing and look to see if the shaft collar is in contact with the bolt housing. If it is, you can use a rotary tool/Dremel tool/drill to try and remove a little material from the bolt housing so that the firing pin shaft collar won't be dragging against the bolt housing. Just be careful not to remove too much material!

Firing pin Channel is Obstructed

Take the drill bit you used to drill out your firing pin channel. Using your drill, drill from the front of the bolt, spinning the drill at a high speed while moving it in and out of the hole. Apply a little silicone oil to the firing pin hole and test again.

Firing pin is Bent

This is an indicator that your headspace might be wrong or your firing pin might have been too long –a firing pin that is too long, especially when headspace isn't right, can puncture primers, which can bend firing pins.

If your firing pin has bent, you can try to straighten it back out (and then shorten it to the specs called out in the documentation), but I recommend you make a whole new firing pin. Refer to the previous section (Troubleshooting Failures to Extract (FTE)) to check your headspace, and refer to the documentation for making a new firing pin/straightening your old one.

Punctured Primers

If you are having punctured primers, you should stop using your FGC-9 and fix this issue. The two things that could cause punctured primers are an issue with headspace and a firing pin with too much extension (too long). If you have punctured primers, first make sure headspace is set correctly –refer to the previous section (Troubleshooting Failures to Extract (FTE)). If you still have punctured primers after ensuring headspace is good, then you will need to make a new firing pin (or identify which end of your firing pin is too long and trim it down to size according to the instructions for making your firing pin).

Failure to Extract due to Firing Pin

This issue is rather uncommon, but I have noticed it before. You can have failures to extract because a firing pin has too much extension. The quick and easy way to check this issue out is to measure how much extension your firing pin has. The best way to do this is to remove the barrel from your gun and let the hammer hit the firing pin –when it comes to a rest, it will be pushing the firing pin to its extended position. While looking from the front of the gun (with the barrel removed), take a note of how far the firing pin is sticking out past the face of the bolt –it should only be 1.25 - 1.75mm.

If it is sticking out a long distance, you might want to make sure that the tip of the firing pin isn't pointed (it should be a flat shape on the tip), and make sure to grind it down a little so that about 1.5mm of the firing pin is sticking out past the bolt face.

Troubleshooting Feeding Issues

If you are experiencing feeding issues with your FGC-9, one of many factors could be involved. Listed below are some of the most common causes, as well as what can be done to mitigate these issues.

- Magazine Related Feeding Issues

Description: Some FGC-9 builds can be picky with their magazines – most often, magazine related feeding issues will cause cartridges to miss the chamber entirely, leading to them popping upwards and ending up between the bolt and the front wall of the upper receiver. Other magazine feeding issues will cause the bolt to shove rounds into the feed ramp and jam.

Solution: Try testing out different magazines. If issues persist using 3D Printed magazines, OEM Glock magazines, and PMAGs or other decent quality magazines, then your issue is likely not magazine related.

- Bad Print/Warping/Incorrect Assembly

Description: Some feeding issues can happen simply due to errors in printing or assembly of your FGC-9. The most common print issues are warping – if your lower receiver warps significantly, it will cause feeding issues. If your upper receiver doesn't have supports removed properly from the pocket that that barrel sits inside, it will cause feeding issues. If the recommended layer heights are not employed, tolerances can stack between printed parts and you might have feeding issues. Another common issue is not fully seating the feed ramp – ensure your feed ramp is pushed to the bottom of the pocket, that there is no support material remaining in its pocket, and that it is screwed in tight.

Solution: If you can't nail down your feeding issue, try reprinting any parts that may have warped, ensure all supports were removed from your upper and lower and reassemble everything, and double-check that you didn't skip any steps in the assembly process described in this document.

- Bolt-Related Feeding Issues

Description: The bolt on the FGC-9 can be to blame for some feeding issues. The first couple things to check – make sure that the firing pin spring hasn't collapsed by pushing on the end of the firing pin – you should feel spring pressure/resistance before the firing pin protrudes from the bolt face. After verifying that there is spring pressure, remove your firing pin from the bolt – assuming you used Loctite on the firing pin retaining screw, the screw and nut will be stiff and hard to separate, but with a little strength they will come apart.

Some bolts have issues that can cause feeding trouble – with a little fitting, these issues can be resolved. Any bolt can have these same sorts of issues show up – so if your feeding issue isn't the result of bad magazines, your lower isn't warped, your upper had supports removed, and your feed ramp is properly seated, trouble shoot your bolt using the following instructions:

If your feeding issues look like rounds are just getting stuck/wedged into the barrel and just quite won't chamber, or if your rounds get badly damaged when feeding, then you likely have a bolt-related feeding issue.



Figure 1: Example of round badly damaged by bolt-related feeding issue

Solution: There are two very important aspects when it comes to ensuring your FGC-9 bolt is in good working order – the round pickup (the leg at the bottom of the bolt face) needs to be both square and flush with the bolt face, and the bolt face itself must be free of any snags. Begin by checking for snags, since it's easy to do. Take a cartridge case (or complete cartridge, either works) and hold it at a 45 degree angle to the bolt face. If you look closely, the rear end of the cartridge has a little 45 degree angle on the rear end of it – you'll want to hold that face flat against the bolt. Starting from the bottom of the round pickup, slide the cartridge up the bolt, applying moderate pressure.

The case may drag some if the bolt face isn't perfectly smooth, but that's ok. What you're checking for is any point where the case snags – where it locks against the bolt face and won't move up any higher.

Snags commonly show up between the round pickup and lower bolt rod and around the firing pin channel. Pay close attention when sliding the rounds past these points on the bolt. On a good bolt, you may feel a little 'click' or some drag in these spots, but the cartridge *should not* lock, snag, or feel like it's digging in.



Figure 2: While holding the case at a 45-degree angle to the bolt face, apply moderate pressure (pushing the case against the bolt face) while sliding the case upwards. The case should not snag at any point, but a little resistance or some bumps is fine.

If you experience snags, pay close attention to where they happen – if it's at a pockmark in the bolt face, at the firing pin hole, where the round pickup meets the lower bolt rod, etc. The round consistently snags on the bolt face in a certain spot, you will have to smooth things out. It is recommended that you use a Dremel tool with a new cutoff wheel designed for cutting metal, but a normal grinding tool in a Dremel or battery drill can also be used. Try and visually identify the point where the cartridge is snagging. It will usually look like an indentation, a sharp edge, or a burr. A sharp edge or sharp chamfer on the firing pin hole can cause snags easily.



Figure 3: Example of a firing pin hole with a sharp edge. If your firing pin hole has a sharp edge like this and you are having feed issues or feel snagging when sliding cases on the bolt face, you will need to smooth out the top edge of the hole.

Once you've made sure of where the snag is happening, take your Dremel tool or drill and smooth this area out. Make very light cuts. Coloring the area of the snag with sharpie marker can help you identify where you are removing material from. Wherever your snag is happening, ensure that the metal you are removing is making the snag less likely by smoothing things out – don't add any new gouges. If your firing pin hole is causing snags, then you can use the edge of your Dremel cutting wheel/grinding tool to 'blend' the edge of the hole out – using light cuts, make the edge of the hole more rounded/smooth. Remove a little metal, then drag a case across the bolt face and check for snags. Repeat as necessary, until the case doesn't snag any more. Avoid removing excessive material from the bolt face, especially around the firing pin hole – you just want to blend out any sharp edges.

The recommended technique for smoothing out the sharp edge on a firing pin hole is as follows:

Take a Dremel tool with a cutting wheel and your bolt. Using slow, gentle swooping motions starting from the middle of the firing pin hole to smooth out the top of the firing pin hole.



Figure 4: Rounding out the top of the firing pin hole. Use light cuts, starting from the middle of the firing pin hole, and scoop up towards the top of the firing pin hole.

After a few swooping cuts, check to see if your round still snags. If it does, you may need to either round out the sides of the firing pin hole, or just round out the top a little bit more. For reference, this is as much rounding as the top of the firing pin hole should ever need:



Figure 5: Top of firing pin hole rounded out. Try not to remove more material than this.

If you have removed as much material as seen in the previous picture, you should try rounding out the sides of the firing pin hole a little – this can be accomplished using a different technique:

Starting from the left or right side of the firing pin hole, make light cuts in an arc, following the curvature of the firing pin hole.

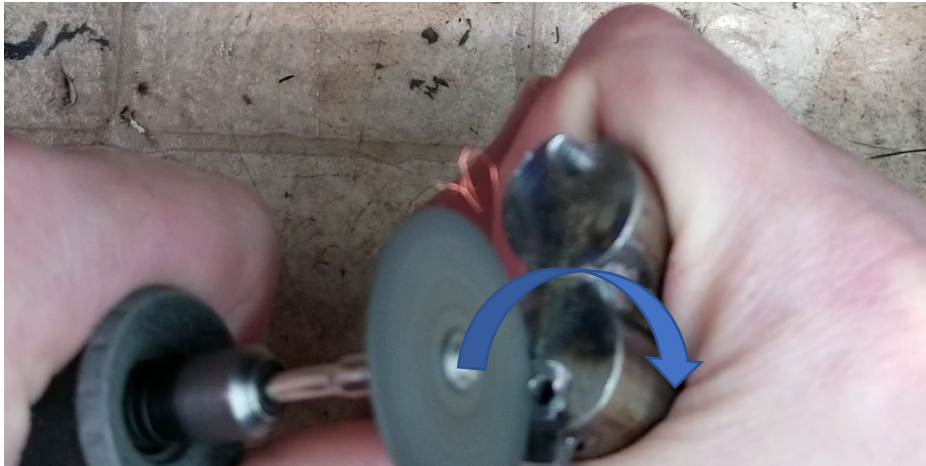

Figure 6: Use gentle, light cuts in an arc around the firing pin hole to round out the edges of the hole.

After a few passes, check and see if your case is still snagging. At this point, you may feel drag or the bump from the rounded edge you've made on the bolt face, but there should be no hard snagging like you felt before. Try not to exceed the amount of material removed in the following picture:



Figure 7: Maximum suggested removal from bolt face.

After making these cuts and doing some tests by dragging cases up the bolt face, you should be ready to do some basic feeding tests – refer to the “Testing cartridge feeding” section of the manual to test feeding. With even a little rounding on the sharp edge of a firing pin hole, feeding issues can disappear.

After checking for any snags, check the round pickup itself – the shape of the pickup is very important, and if it's done wrong then all manner of strange feeding issues can occur.

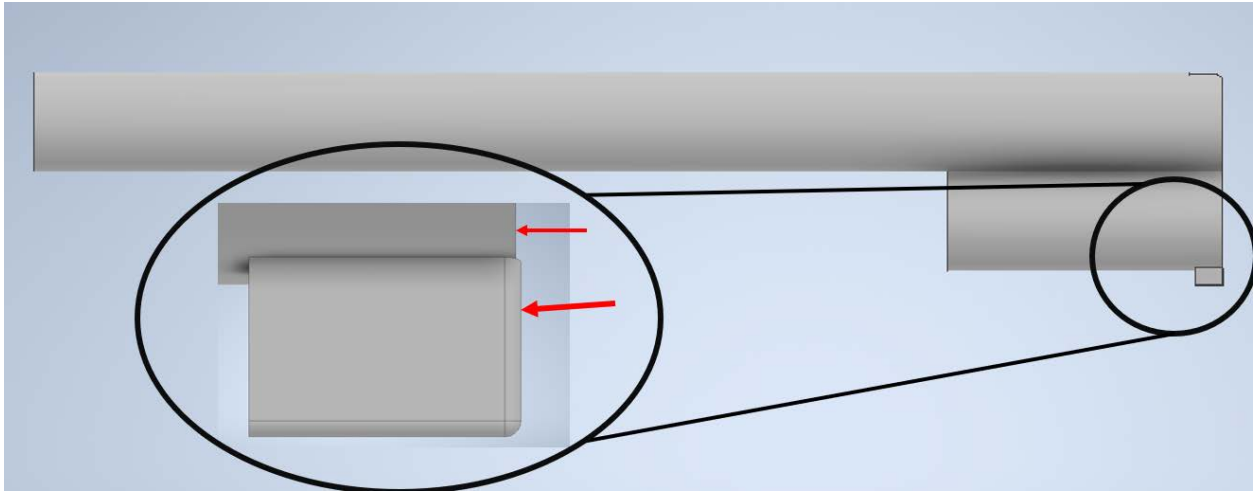

Figure 8: Bolt that is square, but not flush.

If your bolt face is square, but not flush, it just needs a little file work or Dremel tool work to make the parts flush.

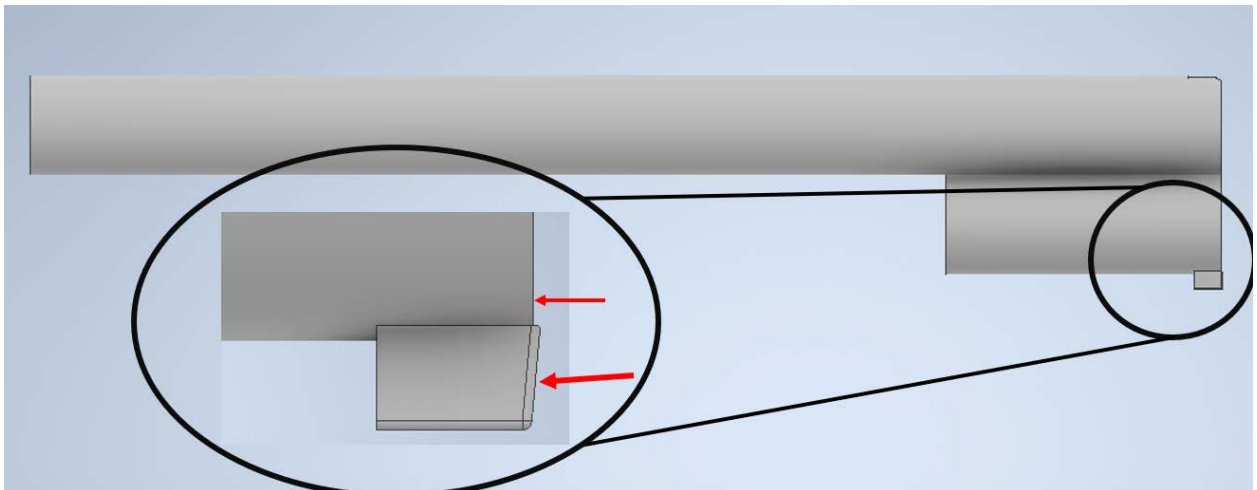

Figure 9: Bolt that is neither square nor flush

If your bolt face is neither square nor flush, you will need to use a Dremel tool or a file to make it both square and flush. You may need to use a little JB Weld afterwards to bridge any gap between the lower bolt rod and the round pickup.

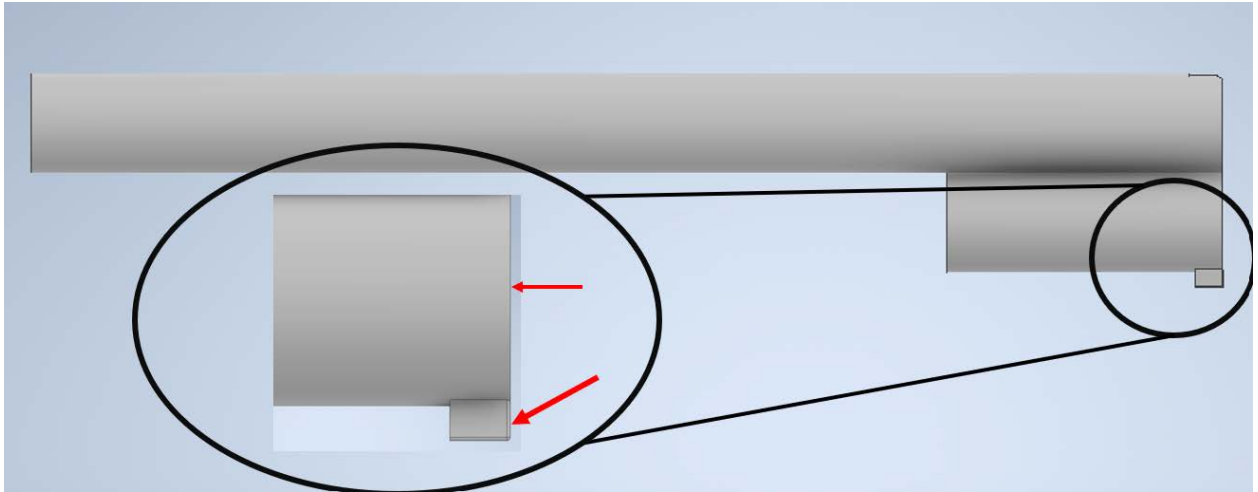

Figure 10: Bolt that is flush and square

If your round pickup is both flush and square, then your issue isn't your round pickup – unless your pickup is sticking too far down. If your pickup extends more than 0.25mm below the height of the rib on the bolt housing, you might have to grind it down a little.

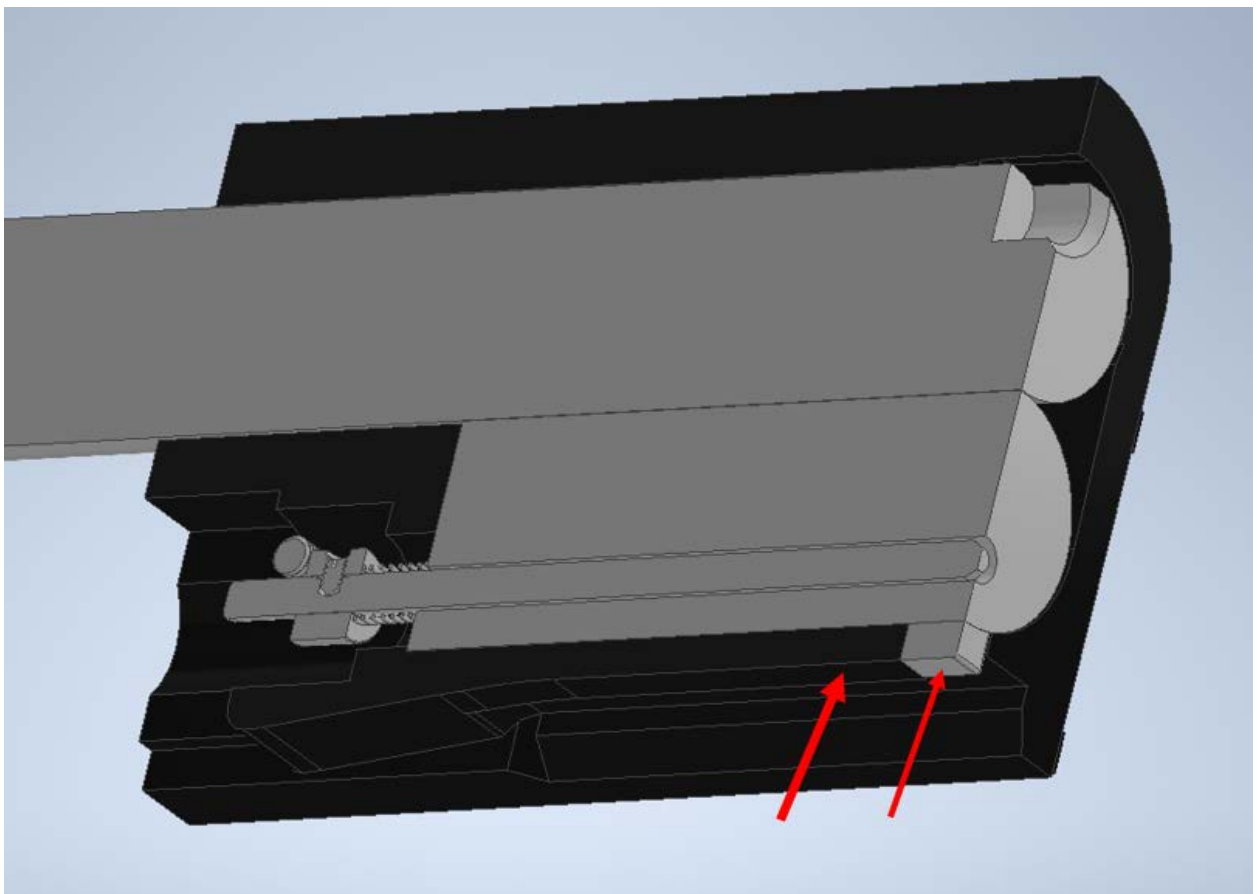

Figure 11: The height of the bottom of the round pickup should align with the height of the rib on the bottom of the bolt housing.

Out-of-battery discharge

The FGC-9 can fire a significant distance out of battery.

This is an intentional design decision, as leaving a large 'go-zone' for the hammer to be able to fire a cartridge, ensures that the builder can deviate from specs for the firing pin, bolt and chamber dimensions and still have a reliable build.

As with many improvised firearms, this trade-off is made such that the firearm is easier to build and more reliable with a wide range of deviation from the spec, but at the cost of some level of safety.

Out of battery discharges are a failure where a cartridge that isn't fully seated in the chamber is set off by the hammer. Because the cartridge isn't fully supported by the chamber, the side walls of the cartridge will blow out, venting gas pressure and some small shrapnel from the breech of the barrel.

This type of malfunction is not uncommon in firearms, especially improvised firearms – however, because the FGC-9 uses plastic for its receiver, out of battery discharges will seriously damage the upper receiver and disable the gun and require repairs whereas out of battery discharges in most steel constructed 9x19mm firearms just leave debris to clear and the weapon is ready to continue shooting.

So long as the shooter wears safety glasses and does not place their hands, face, or other soft tissue over the ejection port of their FGC-9, out of battery discharges pose relatively low risk of injury with the FGC-9 design.

The main cause for Out-of-battery discharges in previous cases with earlier FGC-9 MkII builds, were the usage of third party firing pins and firing pin springs.

With third party components you have to be absolutely sure that they meet the specifications described in this guide. Otherwise you are risking malfunctions and even severe damage to your gun and yourself.