



portuguese english



OVER 6,000 WORDS
AND PHRASES

BILINGUAL
DICTIONARY

VISUAL



Bilingual
VISUAL
dictionary

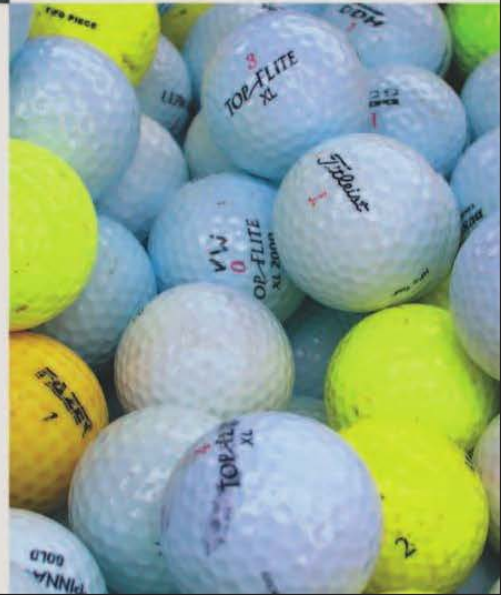
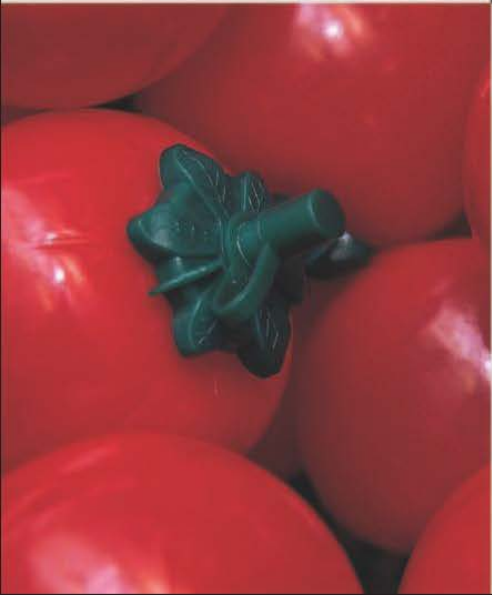
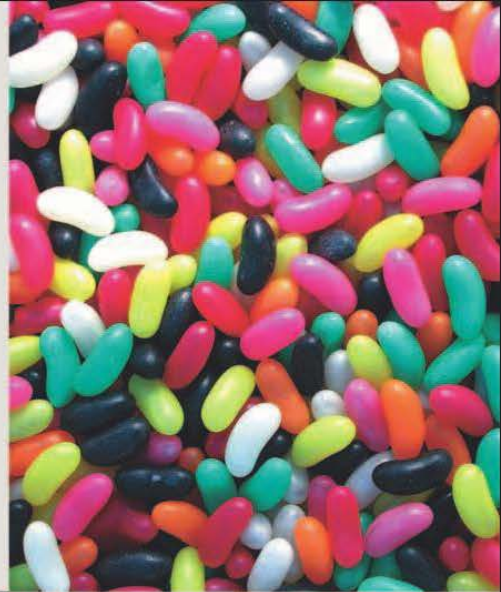

Bilingual

VISUAL

dictionary



A DORLING KINDERSLEY BOOK



LONDON, NEW YORK, MELBOURNE, MUNICH, AND DELHI

Senior Editor Scarlett O'Hara
Senior Art Editor Vicky Short
Production Editor Phil Sergeant
Production Controller Danielle Smith
Managing Art Editor Louise Dick
Managing Editor Julie Oughton
US Editor Liza Kaplan

Designed for Dorling Kindersley by WaltonCreative.com

Art Editor Colin Walton, assisted by Tracy Musson
Designers Peter Radcliffe, Earl Neish, Ann Cannings
Picture Research Marissa Keating

Language content for Dorling Kindersley by
First Edition Translations Ltd., Cambridge, UK

Translator Maria Hooper
Editor Norma Tait
Typesetting Writeldea

First American Edition, 2010

Published in the United States by
DK Publishing
375 Hudson Street
New York, New York 10014

10 11 12 10 9 8 7 6 5 4 3 2 1

177768—May 2010

Copyright © Dorling Kindersley Limited
All rights reserved.

Without limiting the rights under copyright reserved above,
no part of this publication may be reproduced, stored in or
introduced into a retrieval system, or transmitted, in any
form, or by any means (electronic, mechanical, photocopying,
recording, or otherwise), without the prior written permission of
both the copyright owner and the above publisher of this book.

Published in Great Britain by Dorling Kindersley Limited.

A catalog record for this book is available from the
Library of Congress.

ISBN: 978-0-7566-6209-7

DK books are available at special discounts when purchased in bulk for
sales promotions, premiums, fund-raising, or educational use.
For details, contact: DK Publishing Special Markets, 375 Hudson Street,
New York, New York 10014 or SpecialSales@dk.com.

Printed by Tlaciarne BB s.r.o., Slovak Republic

Discover more at

www.dk.com

índice contents

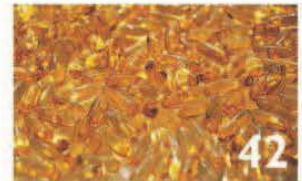

42

a saúde
health



146

comer fora
eating out

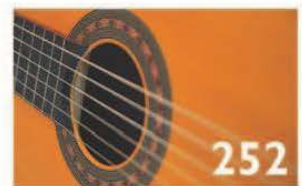

252

o lazer
leisure



6
sobre o dicionário
about the dictionary



8
como utilizar este livro
how to use this book



10
as pessoas
people



28
a aparência
appearance



56
o lar
home



92
os serviços
services



102
as compras
shopping



116
os alimentos
food



160
o estudo
study



170
o trabalho
work



192
os transportes
transport



218
os desportos
sports



278
o ambiente
environment



302
referência
reference



324
índice
index



360
agradecimentos
acknowledgments

as pessoas • people

o corpo body	12
a cara face	14
a mão hand	15
o pé foot	15
os músculos muscles	16
o esqueleto skeleton	17
os órgãos internos internal organs	18
os órgãos reprodutores reproductive organs	20
a família family	22
as relações relationships	24
as emoções emotions	25
os acontecimentos da vida life events	26

**a aparência •
appearance**

a roupa de criança children's clothing	30
a roupa de homem men's clothing	32
a roupa de senhora women's clothing	34
os acessórios accessories	36
o cabelo hair	38
a beleza beauty	40

a saúde • health

a doença illness	44
o médico doctor	45
a lesão injury	46
os primeiros socorros first aid	47
o hospital hospital	48
o dentista dentist	50
o oculista optician	51
a gravidez pregnancy	52
o parto childbirth	53
as terapias alternativas alternative therapy	54

o lar • home

a casa house	58
as instalações internas internal systems	60
a sala de estar living room	62
a sala de jantar dining room	64
a cozinha kitchen	66
os utensílios de cozinha kitchenware	68
o quarto de dormir bedroom	70
a casa de banho bathroom	72
o quarto das crianças nursery	74
a lavandaria utility room	76
a oficina workshop	78
a caixa das ferramentas toolbox	80
a decoração decorating	82
o jardim garden	84
as plantas de jardim garden plants	86
as ferramentas de jardinagem garden tools	88
a jardinagem gardening	90

os serviços • services

os serviços de emergência emergency services	94
o banco bank	96
as comunicações communications	98
o hotel hotel	100

**as compras •
shopping**

o centro comercial shopping centre	104
os grandes armazéns department store	105
o supermercado supermarket	106
a farmácia chemist	108
a florista florist	110
o vendedor de jornais newsagent	112
o vendedor de doces confectioner	113
as outras lojas other shops	114

os alimentos • food

a carne meat	118
o peixe fish	120
os legumes vegetables	122
a fruta fruit	126
os grãos e as leguminosas grains and pulses	130
as ervas aromáticas e especiarias herbs and spices	132
os alimentos engarrafados bottled foods	134
os laticínios dairy produce	136
os pães e as farinhas breads and flours	138
os bolos e as sobremesas cakes and desserts	140
a charcutaria delicatessen	142
as bebidas drinks	144



comer fora •		os desportos • sport	
eating out		o futebol americano	220
o café café	148	American football	
o bar bar	150	o rãguebi rugby	221
o restaurante restaurant	152	o futebol soccer	222
a comida rápida	154	o hóquei hockey	224
fast food		o críquete cricket	225
o pequeno-almoço breakfast	156	o basquetebol basketball	226
o jantar dinner	158	o basebol baseball	228
o estudo • study		o ténis tennis	230
a escola school	162	o golfe golf	232
a matemática maths	164	o atletismo athletics	234
as ciências science	166	os desportos de combate	236
o ensino superior	168	combat sports	
college		a natação swimming	238
o trabalho • work		a vela sailing	240
o escritório office	172	a equitação horse riding	242
o computador computer	176	a pesca fishing	244
os meios de comunicação media	178	o esquí skiing	246
a lei law	180	outros desportos	248
a quinta farm	182	other sports	
a construção construction	186	a forma física	250
as profissões professions	188	fitness	
os transportes •		o lazer • leisure	
transport		o teatro theatre	254
as estradas roads	194	a orquestra orchestra	256
o autocarro bus	196	o concerto concert	258
o carro car	198	o turismo sightseeing	260
a motocicleta motorbike	204	as actividades ao ar livre	262
a bicicleta bicycle	206	outdoor activities	
o comboio train	208	a praia beach	264
o avião aircraft	210	o campismo camping	266
o aeroporto airport	212	o entretenimento no lar	268
o navio ship	214	home entertainment	
o porto port	216	a fotografia	270
		photography	
		os jogos games	272
		as artes manuais	274
		arts and crafts	
		o ambiente •	
		environment	
		o espaço space	280
		a Terra Earth	282
		a paisagem landscape	284
		o tempo weather	286
		as rochas rocks	288
		os minerais minerals	289
		os animais animals	290
		as plantas plants	296
		a cidade town	298
		a arquitectura architecture	300
		referência •	
		reference	
		as horas time	304
		o calendário calendar	306
		os números numbers	308
		os pesos e as medidas	310
		weights and measures	
		o mapa do mundo world map	312
		advérbios e antónimos	320
		partides and antonyms	
		frases úteis	322
		useful phrases	

sobre o dicionário

Está comprovado que a utilização de imagens ajuda na compreensão e retenção da informação. Baseado neste princípio, este dicionário bilingue altamente ilustrado apresenta uma ampla gama de vocabulário útil e actual em duas línguas europeias.

O dicionário está dividido por temas e cobre a maior parte dos aspectos do mundo quotidiano em pormenor, desde o restaurante ao ginásio, da casa ao local de trabalho e desde o espaço ao reino animal. Encontrará também palavras e frases adicionais para utilizar na conversação e para alargar o seu vocabulário.

Este dicionário é um instrumento de referência essencial para todos os que se interessam pelas línguas – é prático, estimulante e fácil de utilizar.

Alguns pontos a observar

As duas línguas são sempre apresentadas na mesma ordem: português e inglês.

Em português, os substantivos mostram-se sempre com os seus artigos definidos a reflectir o género (masculino ou feminino) e o número (singular ou plural), por exemplo:

a semente	as amêndoas
seed	almonds

Os verbos são indicados por um (v) depois do inglês, por exemplo:

colher = harvest (v)

Cada língua tem o seu próprio índice no final do livro. Aí poderá consultar uma palavra em qualquer das duas línguas e ser encaminhado para a(s) página(s) onde a mesma aparece. O género dos substantivos é indicado com as seguintes abreviações:

m = masculino
f = feminino

about the dictionary

The use of pictures is proven to aid understanding and the retention of information. Working on this principle, this highly-illustrated bilingual dictionary presents a large range of useful current vocabulary in two European languages.

The dictionary is divided thematically and covers most aspects of the everyday world in detail, from the restaurant to the gym, the home to the workplace, and from outer space to the animal kingdom. You will also find additional words and phrases for conversational use and for extending your vocabulary.

This is an essential reference tool for anyone interested in languages – practical, stimulating, and easy-to-use.

A few things to note

The two languages are always presented in the same order – Portuguese and English. In Portuguese, nouns are given with their definite articles reflecting the gender (masculine or feminine) and number (singular or plural), for example:

a semente	as amêndoas
seed	almonds

Verbs are indicated by a (v) after the English, for example:

colher = harvest (v)

Each language also has its own index at the back of the book. Here you can look up a word in either of the two languages and be referred to the page number(s) where it appears. The gender of nouns is shown using the following abbreviations:

m = masculine
f = feminine



Brief pronunciation guide

Vowels:

pilha (battery) and mula (mule) – the pronunciation of i and u doesn't change in most words – i like ee in tree, and u like oo in booster

Nasal sounds:

ão, as in "pão" (bread): pown[g]; ãe, as in "mãe" (mother): mayn[g]; õe, as in "feijões" (beans), sounds like oin in point: fayjoinsh

Consonants:

homem (man) – h is always silent at the beginning of the word

tenho (I have) – nh sounds like ny, tenyo

Julho (July) – lh sounds like ly, joolyo

tacho (pan) – ch sounds like sh in shadow
cenoura (carrot) and cidone (cyclone) – c before e and i is soft like s in sand, otherwise it sounds like the c in comer before a, o and u.

taça (cup) – ç always sounds like a soft s as in sun

gelo (ice) and girafa (giraffe) – g sounds like s in measure before e and i

guia (guide) – gu sounds like g in goat before e and i

caro (expensive) and carro (car) – one r sounds like r in Dora and rr is like r in rat
casa (house) – one s between vowels

sounds like z in zebra. Sapato (shoe) – the initial s sounds like s in sun. Passado (past) – ss also sounds like s in sun.

táxi (taxi) – x sounds like in the English equivalent taxi. Baixo (low) – x sounds like sh in shop. Próximo (next) – x sounds like c in pace. Exacto (exact) – x sounds like z in

como utilizar este livro

Quer esteja a aprender uma língua nova por motivos de trabalho, prazer ou para se preparar para umas férias no estrangeiro, ou queira aumentar o seu vocabulário numa língua que já conhece, este dicionário é um instrumento de aprendizagem valioso que poderá utilizar de várias maneiras diferentes.

Ao aprender uma nova língua, procure as palavras similares em línguas diferentes e as palavras que parecem similares mas que têm significados totalmente distintos. Poderá também observar como as línguas se influenciaram entre si. Por exemplo, a língua inglesa importou muitos termos de comida de outras línguas europeias, mas, em troca, exportou termos empregados na tecnologia e cultura popular.

Actividades práticas de aprendizagem

- Enquanto anda pela sua casa, local de trabalho ou escola, tente procurar as páginas que se referem a esse local. Poderá então fechar o livro, olhar em seu redor e ver de quantos objectos ou características consegue lembrar-se.
- Lance a si mesmo o desafio de escrever uma história, uma carta ou um diálogo empregando tantos termos de uma determinada página quanto conseguir. Isto ajudá-lo-á a reter o vocabulário e a lembrar-se da ortografia. Se quiser progredir para uma composição mais longa, comece com frases que incorporem 2 ou 3 palavras.
- Se tiver uma boa memória visual, tente desenhar ou decalcar objectos do livro num papel; a seguir feche o livro e escreva as palavras correspondentes abaixo do desenho.
- Quando se sentir mais seguro, escolha palavras do índice na língua estrangeira e veja se sabe o que significam antes de consultar a página correspondente para comprovar se tinha razão.

how to use this book

Whether you are learning a new language for business, pleasure, or in preparation for a holiday abroad, or are hoping to extend your vocabulary in an already familiar language, this dictionary is a valuable learning tool which you can use in a number of different ways.

When learning a new language, look out for cognates (words that are alike in different languages) and false friends (words that look alike but carry significantly different meanings). You can also see where the languages have influenced each other. For example, English has imported many terms for food from other European languages but, in turn, exported terms used in technology and popular culture.

Practical learning activities

- As you move about your home, workplace, or college, try looking at the pages which cover that setting. You could then close the book, look around you and see how many of the objects and features you can name.
- Challenge yourself to write a story, letter, or dialogue using as many of the terms on a particular page as possible. This will help you retain the vocabulary and remember the spelling. If you want to build up to writing a longer text, start with sentences incorporating 2–3 words.
- If you have a very visual memory, try drawing or tracing items from the book onto a piece of paper, then close the book and fill in the words below the picture.
- Once you are more confident, pick out words in the foreign language index and see if you know what they mean before turning to the relevant page to check if you were right.

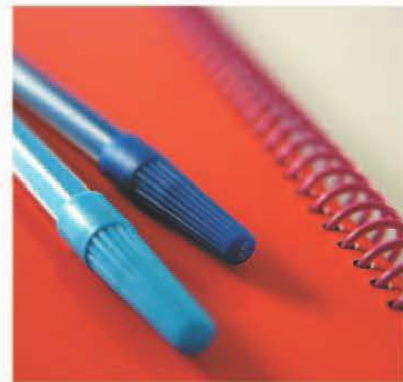





as pessoas
people

o corpo • body

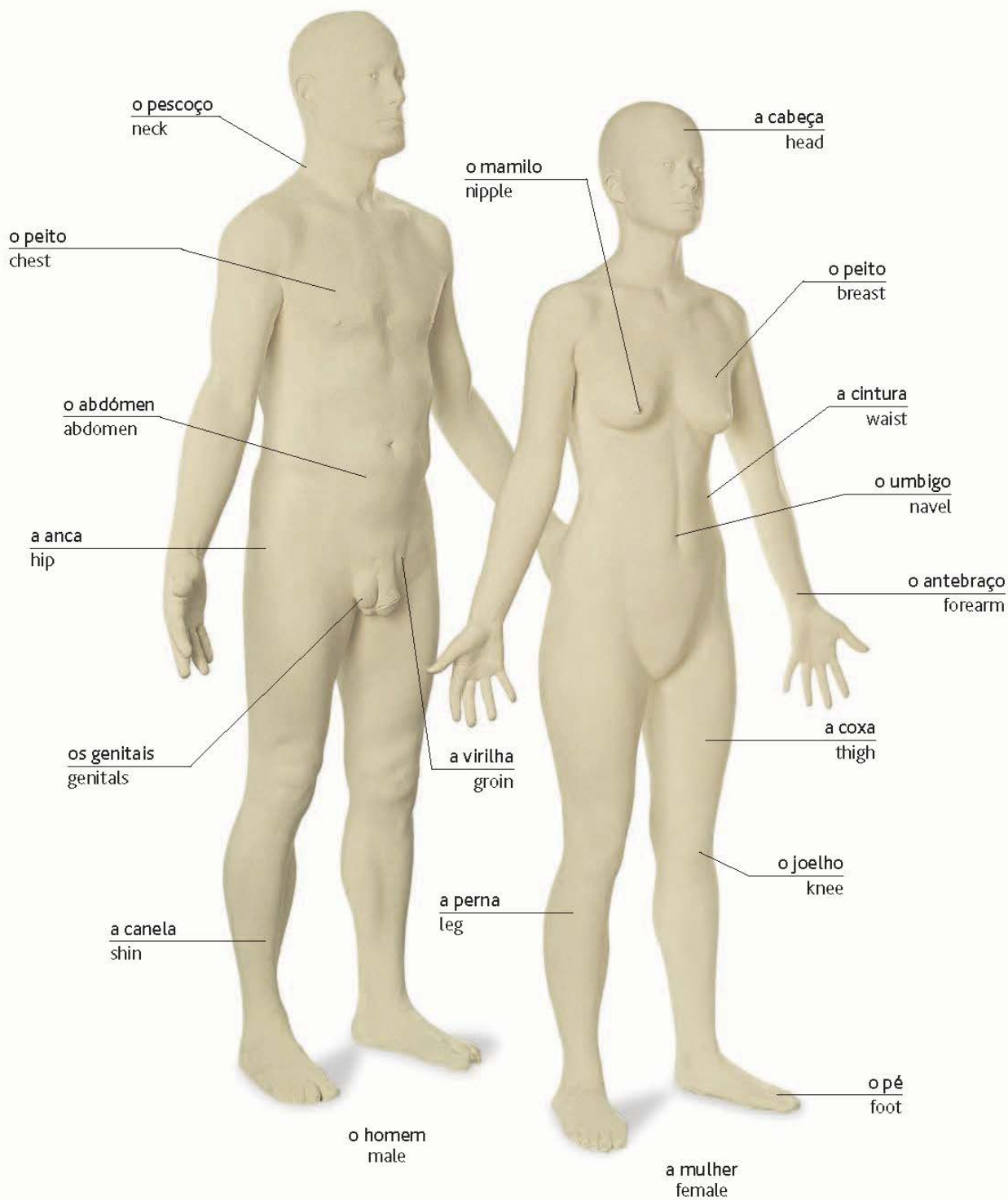

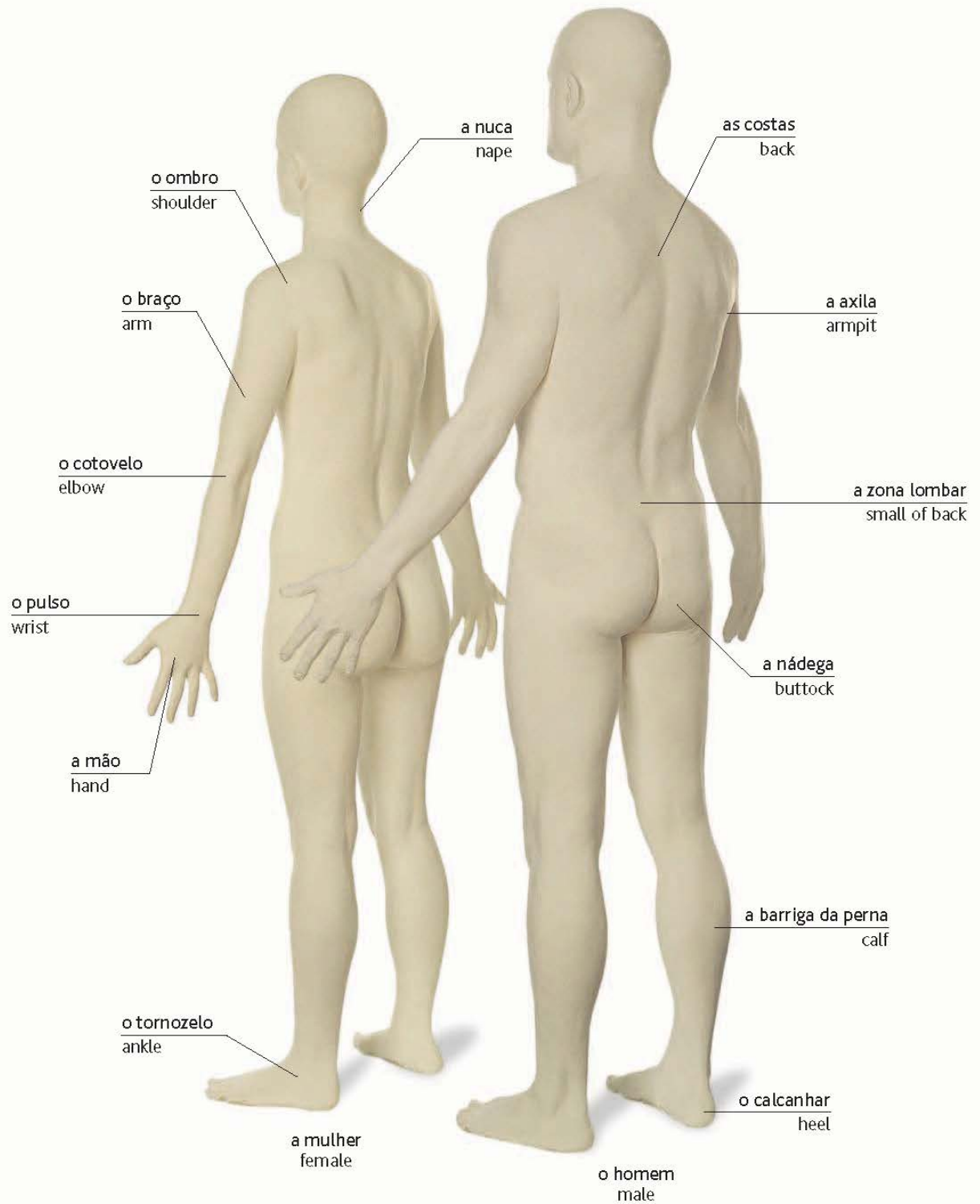

a cara • face

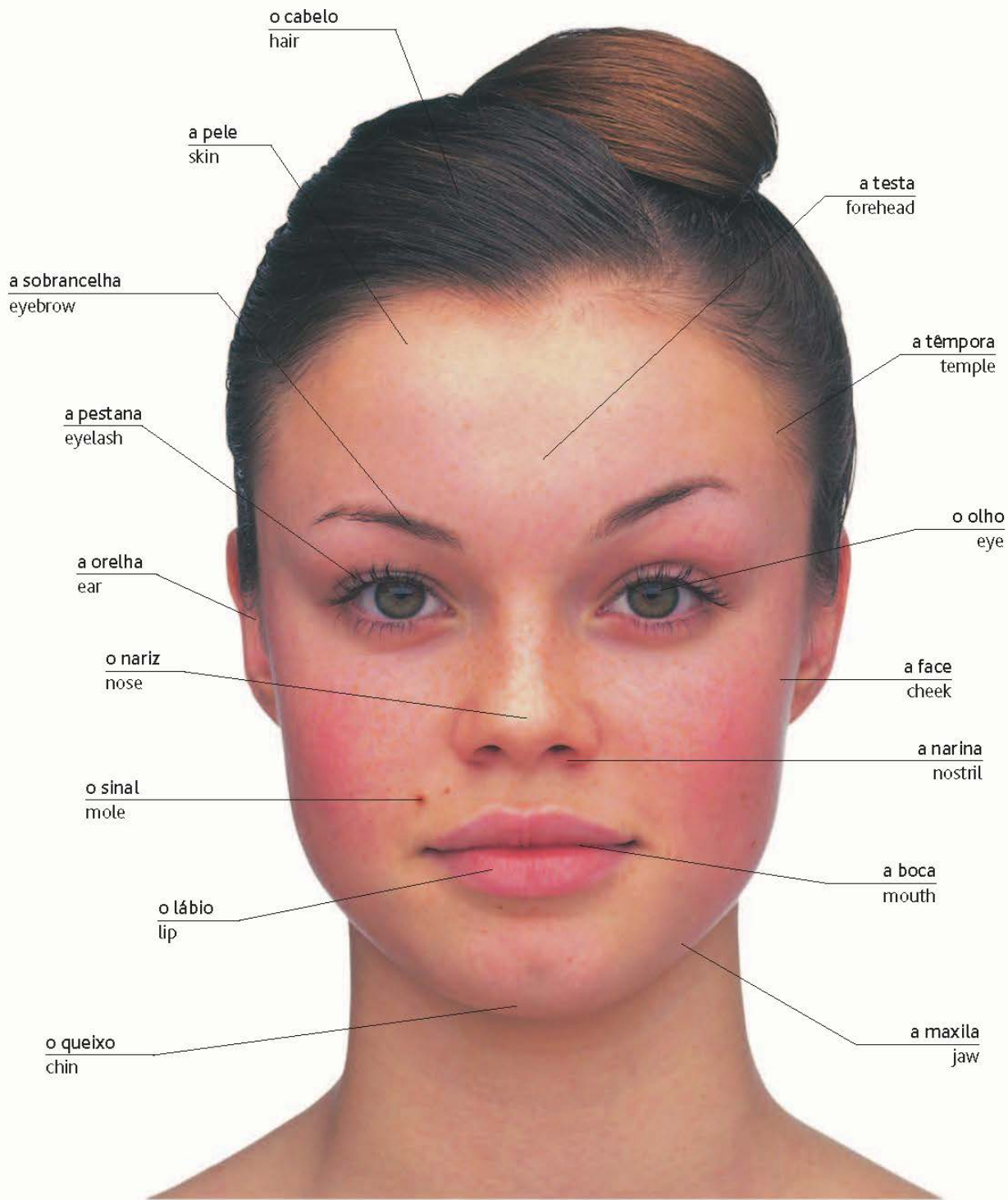

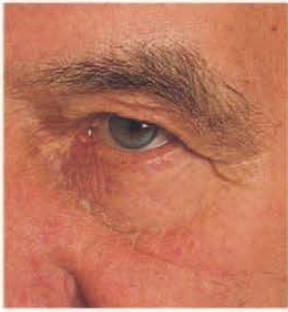

a ruga
wrinkle



a sarda
freckle



o poro
pore



a covinha
dimple

a mão • hand



o pé • foot



os músculos • muscles

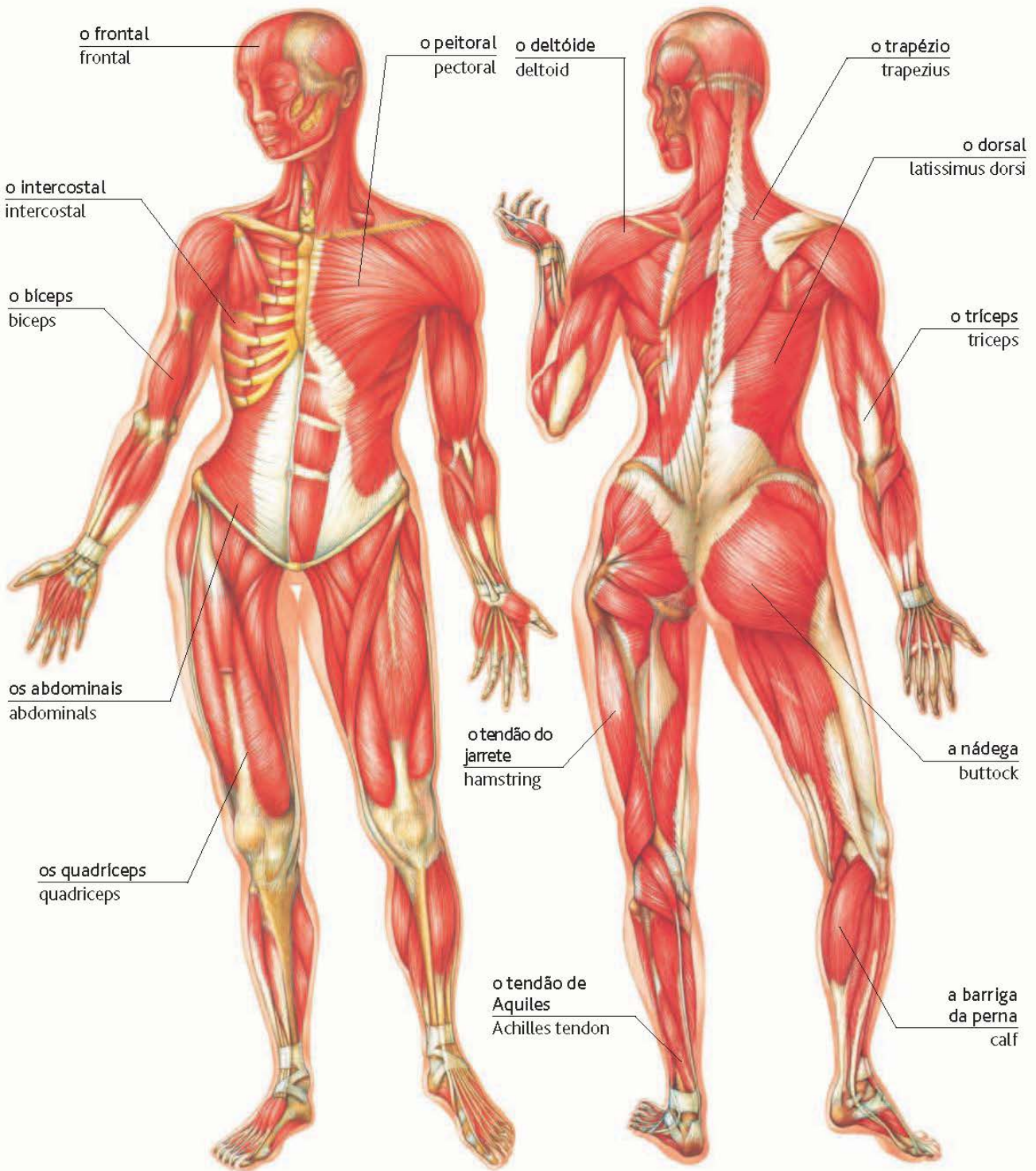

o esqueleto • skeleton

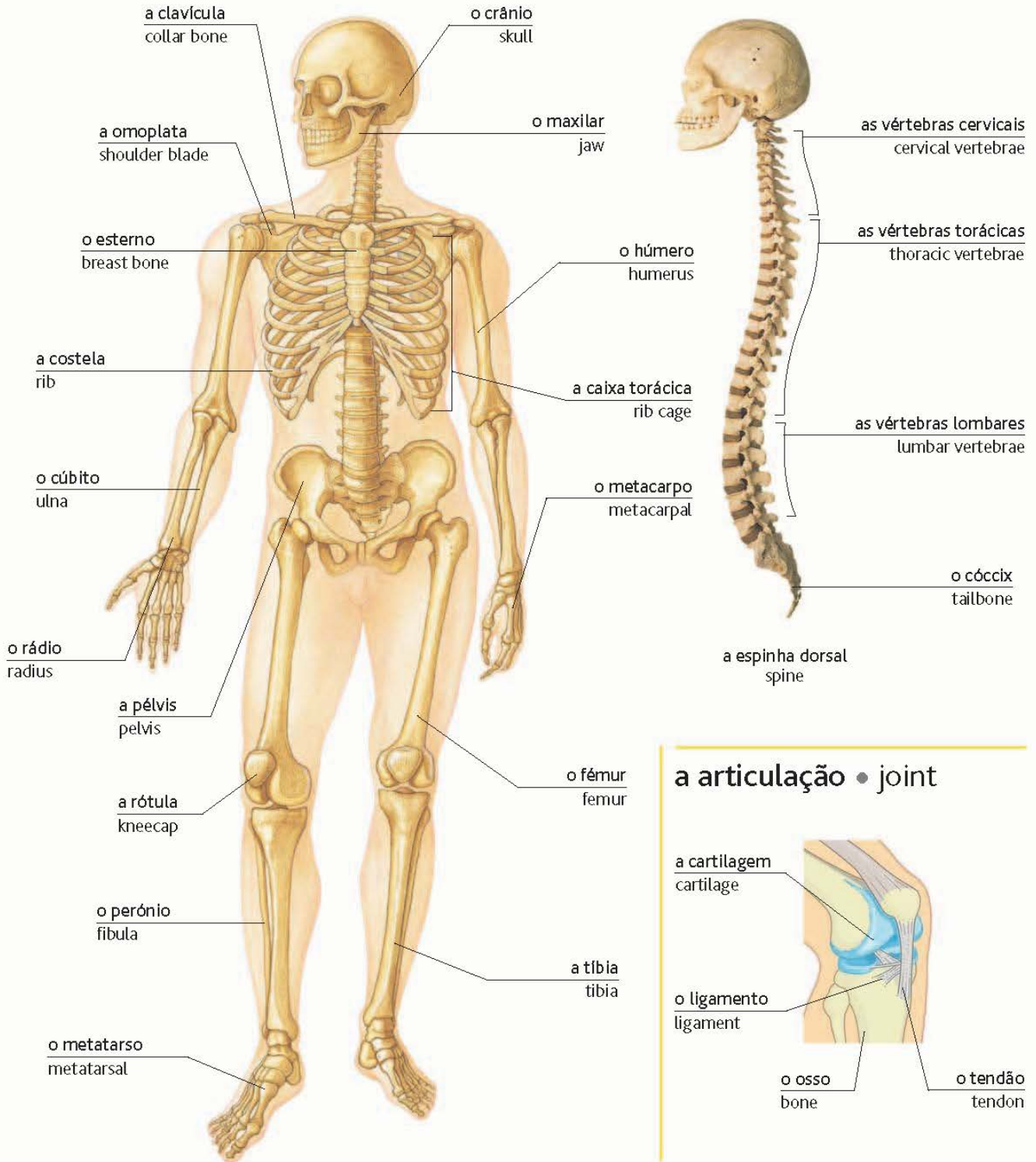

os órgãos internos • internal organs

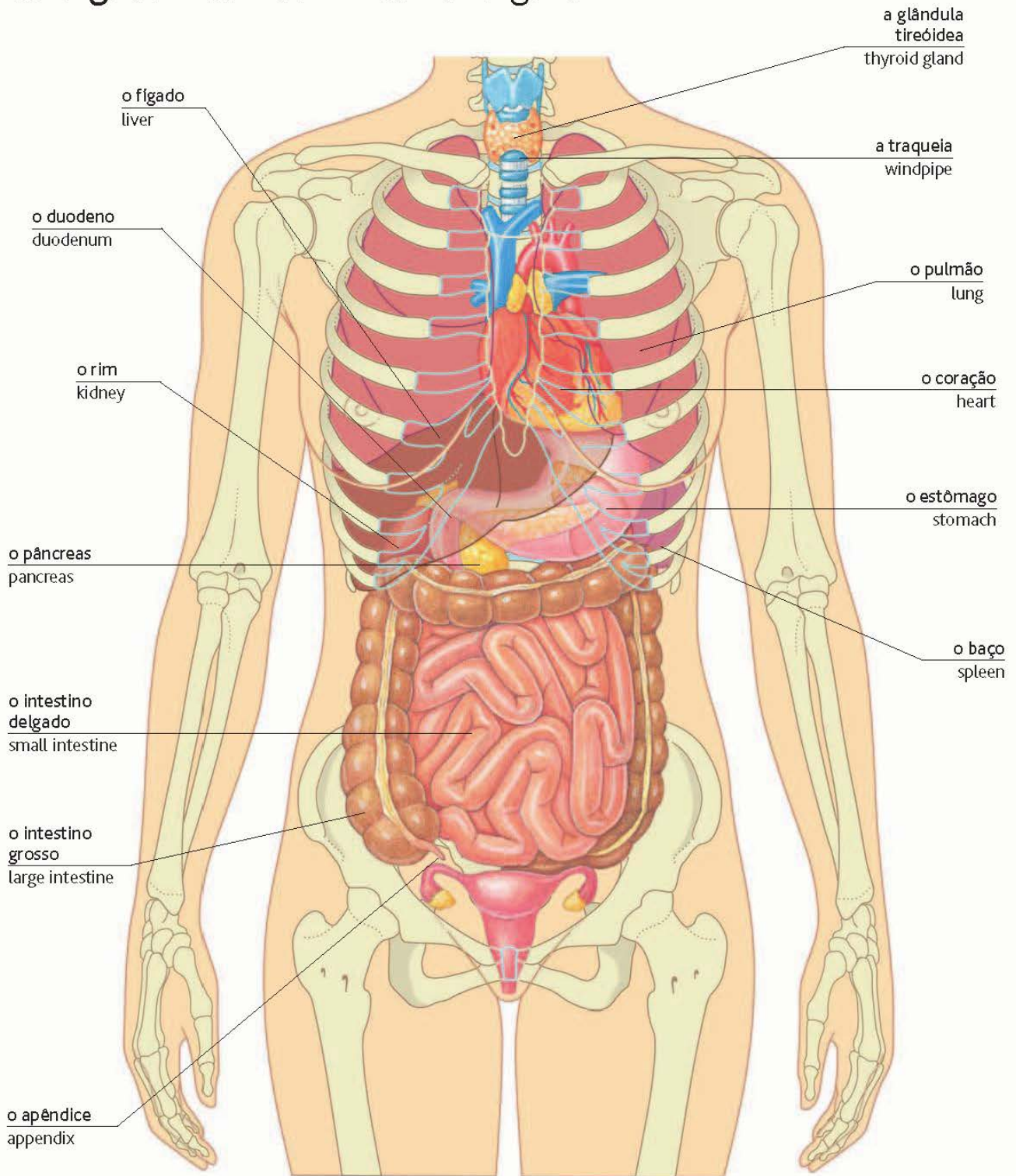

a cabeça • head

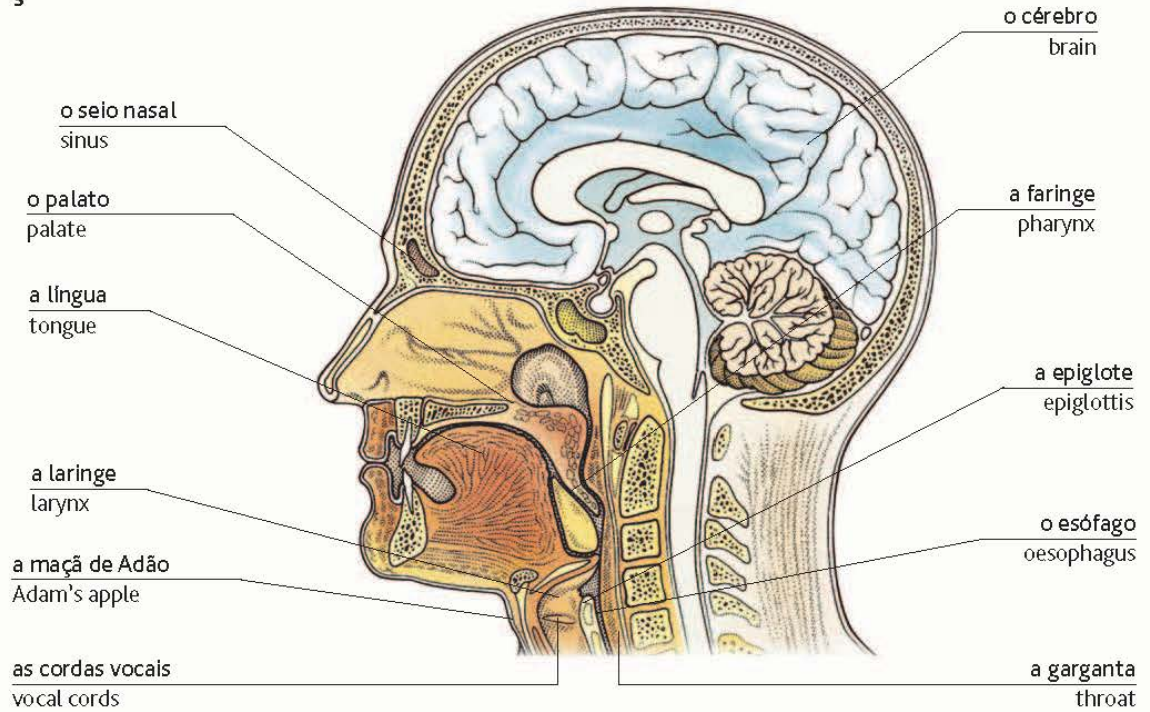

os sistemas • body systems

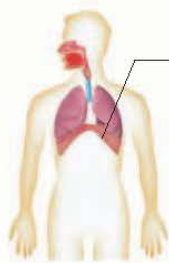

respiratório
respiratory

o diafragma
diaphragm

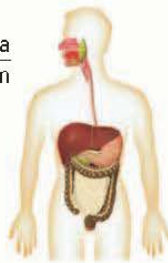

digestivo
digestive

a veia
vein



cardiovascular
cardiovascular

a artéria
artery



linfático
lymphatic

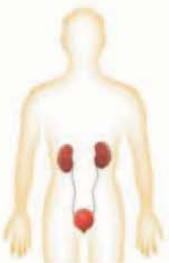

urinário
urinary

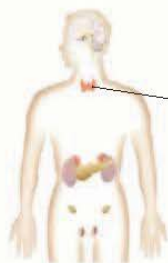

endócrino
endocrine

a glândula
gland



nervoso
nervous

o nervo
nerve



reprodutor
reproductive

os órgãos reprodutores • reproductive organs

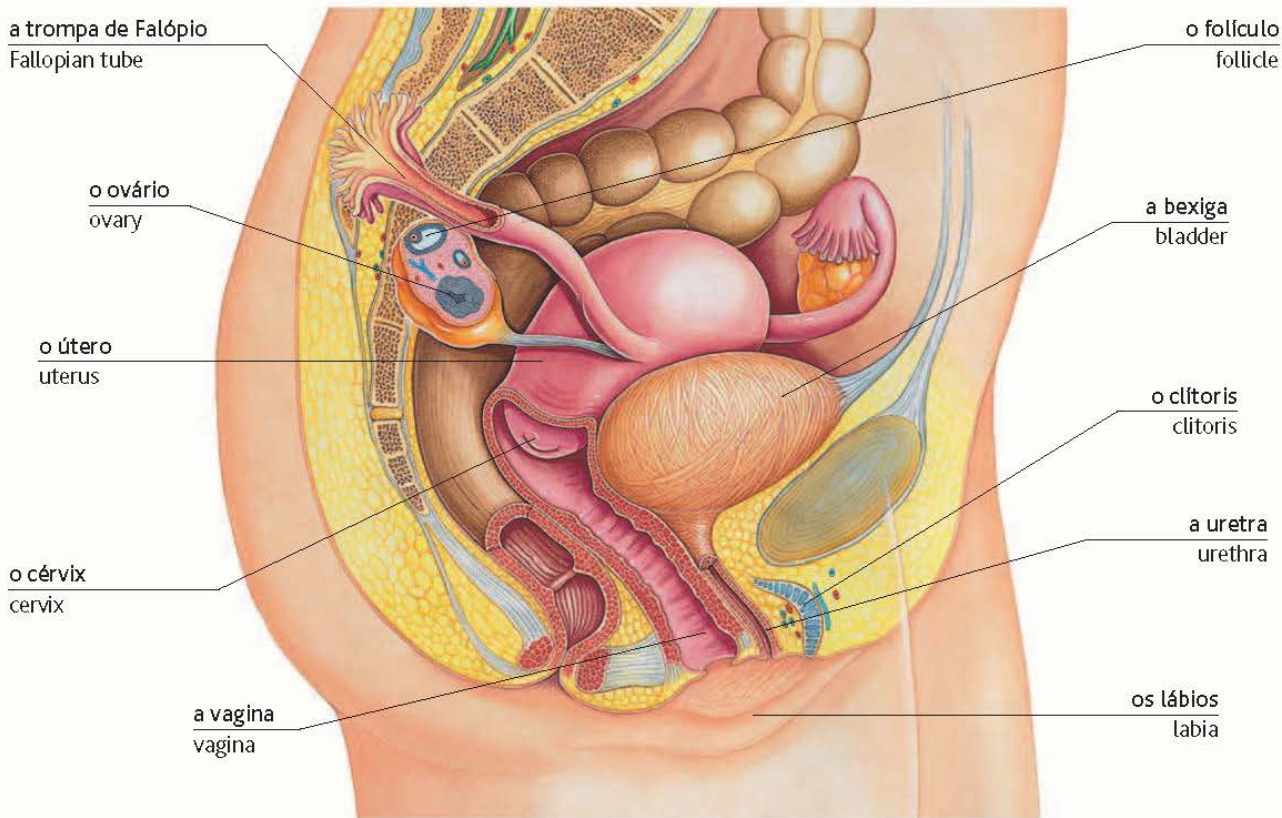

femininos | female

a reprodução • reproduction

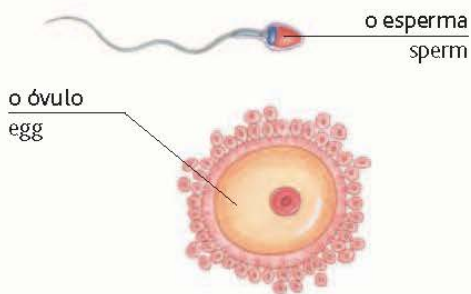

a fertilização | fertilization

vocabulário • vocabulary

a hormona / hormone	impotente / impotent	a menstruação / menstruation
a ovulação / ovulation	fértil / fertile	o coito / intercourse
estéril / infertile	conceber / conceive	a doença de transmissão sexual / sexually transmitted infection

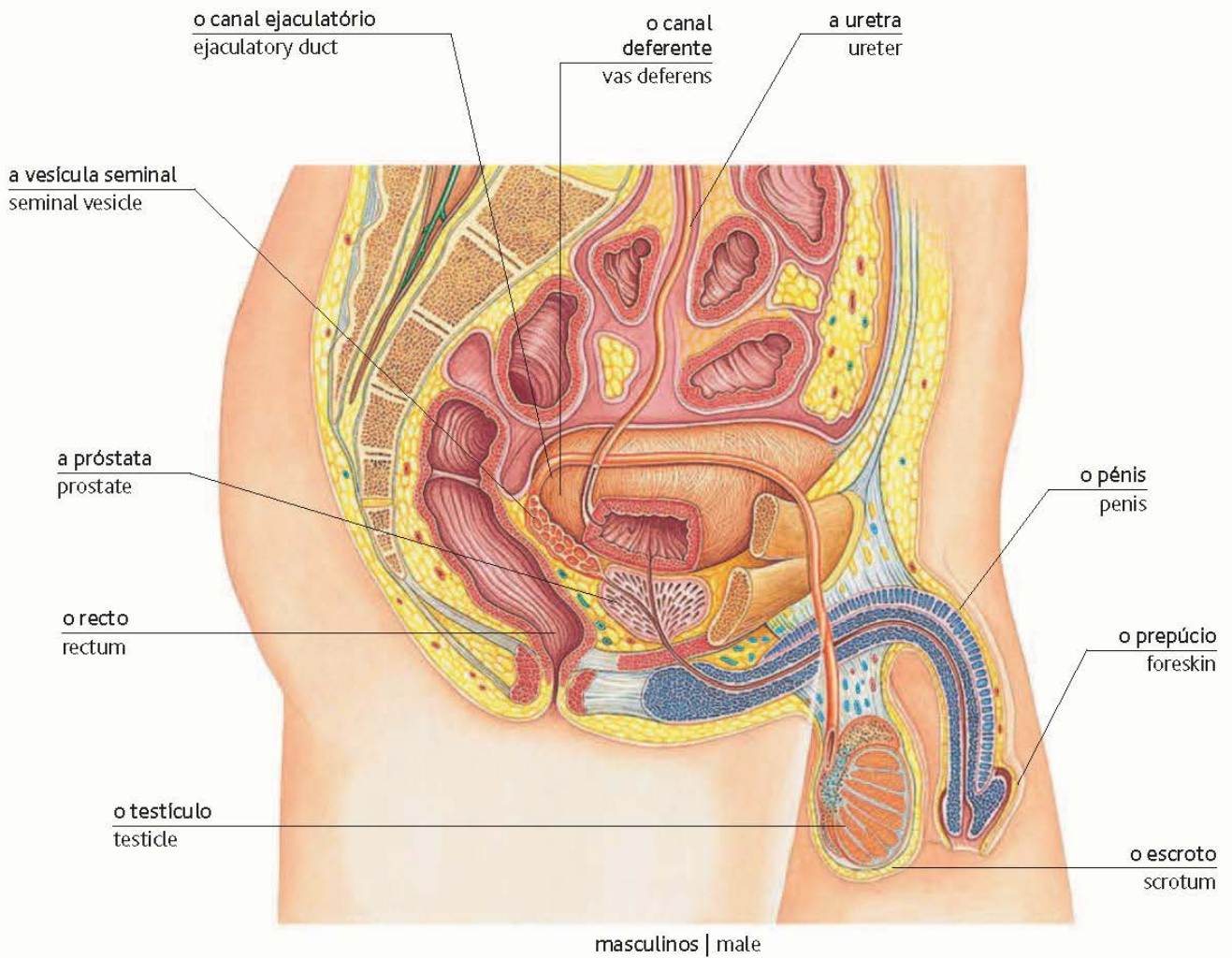

a contracepção • contraception



a família • family

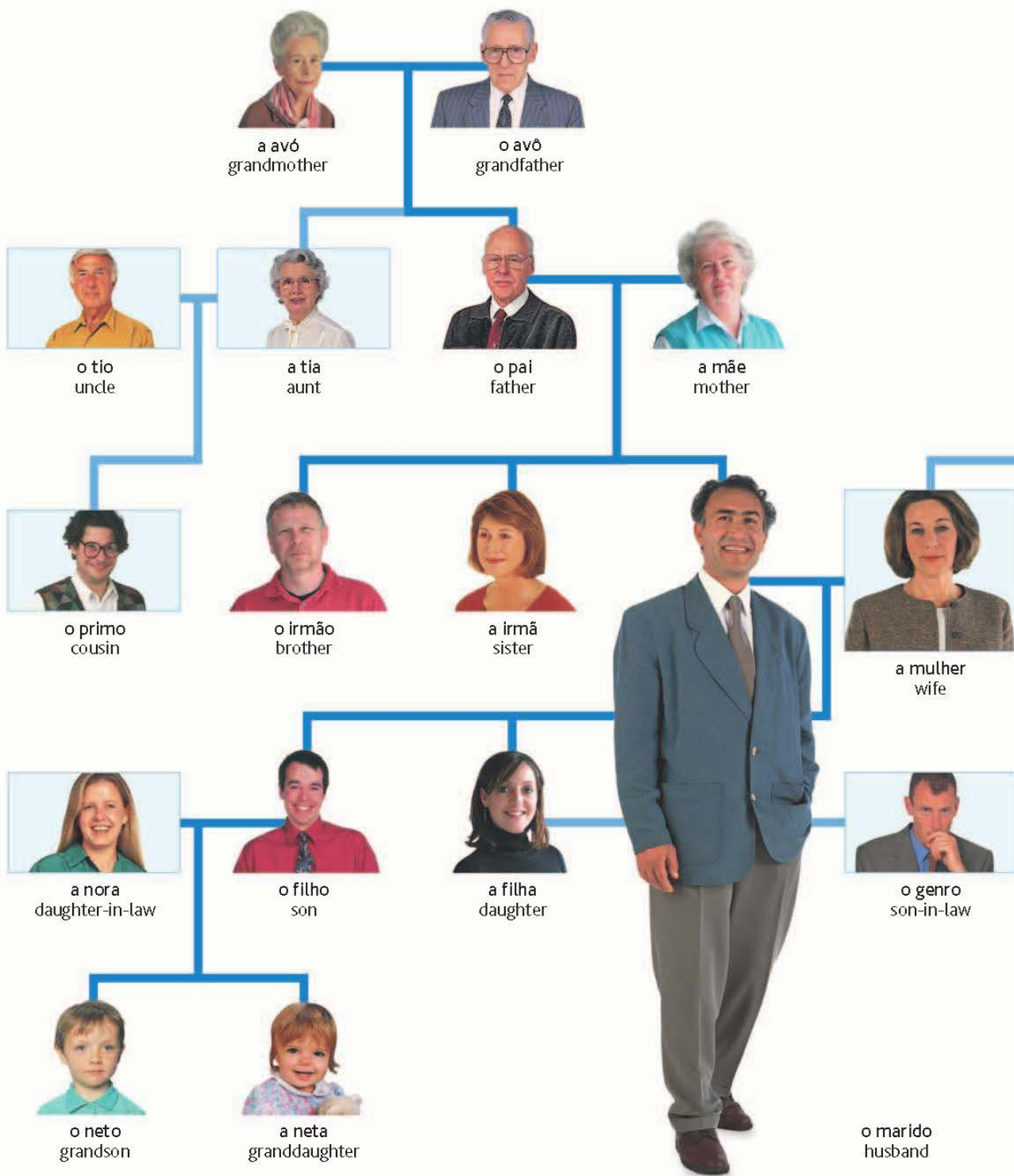

o vocabulário • vocabulary

os parentes
relatives

os pais
parents

os netos
grandchildren

a madrastra
stepmother

o enteado
stepson

a geração
generation

os avós
grandparents

os filhos
children

o padrasto
stepfather

a enteada
stepdaughter

o/a companheiro/a
partner

os gémeos
twins



a sogra
mother-in-law

o sogro
father-in-law



o cunhado
brother-in-law

a cunhada
sister-in-law



a sobrinha
niece

o sobrinho
nephew

Senhora
Mrs.

as formas de
tratamento • titles

Menina
Miss

Senhor
Mr.

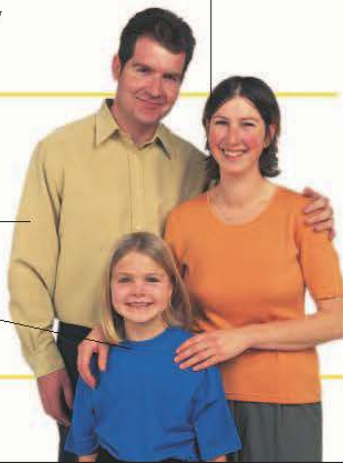

as fases da vida • stages



o bebé
baby



a criança
child



o rapaz
boy



a rapariga
girl



a adolescente
teenager



o adulto
adult



o homem
man



a mulher
woman

as relações • relationships

o chefe
manager

a auxiliar
assistant

a sócia
business partner

a empregadora
employer

o empregado
employee

o colega
colleague

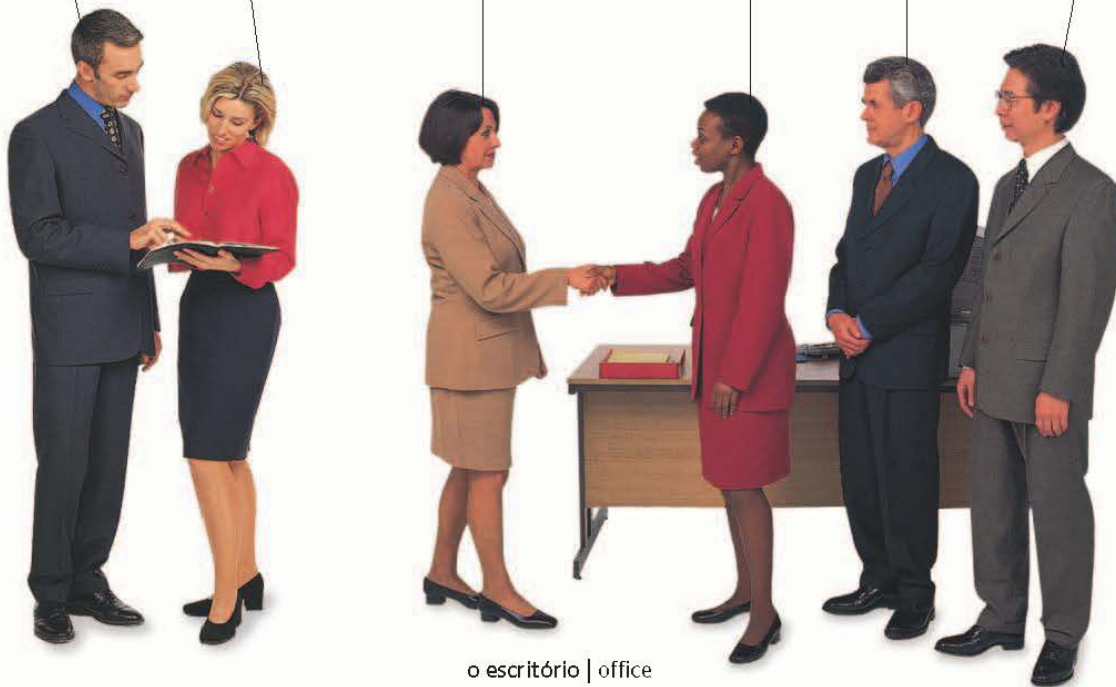

o escritório | office



o vizinho
neighbour



o amigo
friend



o conhecido
acquaintance



o correspondente
pen pal

o namorado
boyfriend



o casal | couple

a namorada
girlfriend

o noivo
fiancé



o casal comprometido | engaged couple

a noiva
fiancée

as emoções • emotions

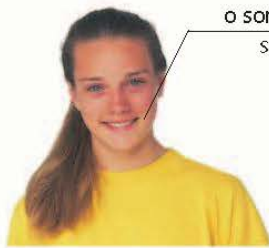

o sorriso
smile

feliz
happy



triste
sad



entusiasmado
excited



aborrecido
bored



surpreendido
surprised



assustado
scared



o sobrolho
franzido
frown

zangado
angry



confuso
confused



preocupado
worried



nervoso
nervous



orgulhoso
proud



confiante
confident



envergonhado
embarrassed



tímido
shy

vocabulário • vocabulary

abalado upset	rir (v) laugh (v)	suspirar (v) sigh (v)	gritar (v) shout (v)
chocado shocked	chorar (v) cry (v)	desmaiar (v) faint (v)	bocejar (v) yawn (v)

os acontecimentos da vida • life events



nascer (v)
be born (v)



começar a escola (v)
start school (v)



fazer amigos (v)
make friends (v)



licenciar-se (v)
graduate (v)



conseguir um emprego (v)
get a job (v)



apaixonar-se (v)
fall in love (v)



casar (v)
get married (v)



ter um filho (v)
have a baby (v)



o casamento | wedding



o divórcio
divorce



o funeral
funeral

vocabulário • vocabulary

o baptizado
christening

morrer (v)
die (v)

o bar mitzvah
bar mitzvah

fazer testamento (v)
make a will (v)

o aniversário
anniversary

a certidão de nascimento
birth certificate

emigrar (v)
emigrate (v)

a festa do casamento
wedding reception

reformar-se (v)
retire (v)

a lua-de-mel
honeymoon

as celebrações • celebrations

a festa de anos
birthday party



o aniversário
birthday

o cartão
card



a prenda
present



o Natal
Christmas

os festivais
• festivals



a Páscoa judia
Passover

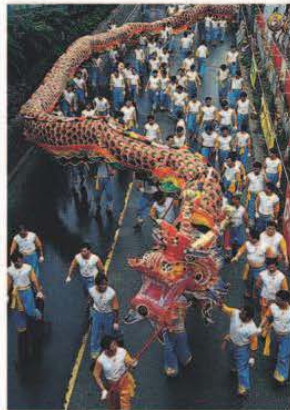

o Ano Novo
New Year



o Carnaval
carnival

o desfile
procession

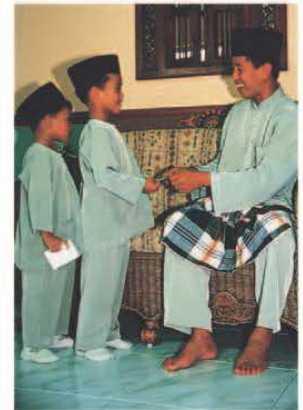

o Ramadão
Ramadan

a fita
ribbon

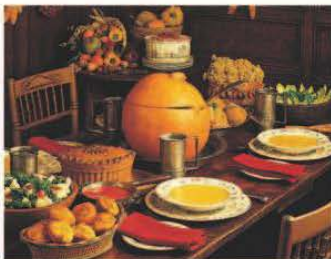

o dia de Acção de Graças
Thanksgiving



a Páscoa
Easter



o dia de Halloween
Halloween

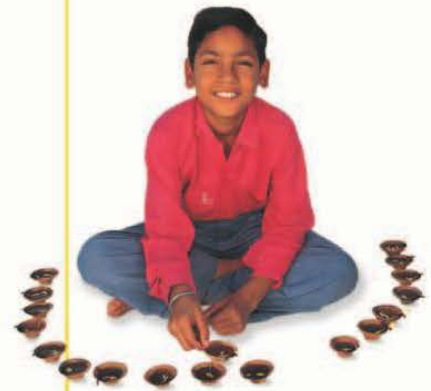

o Diwali
Diwali



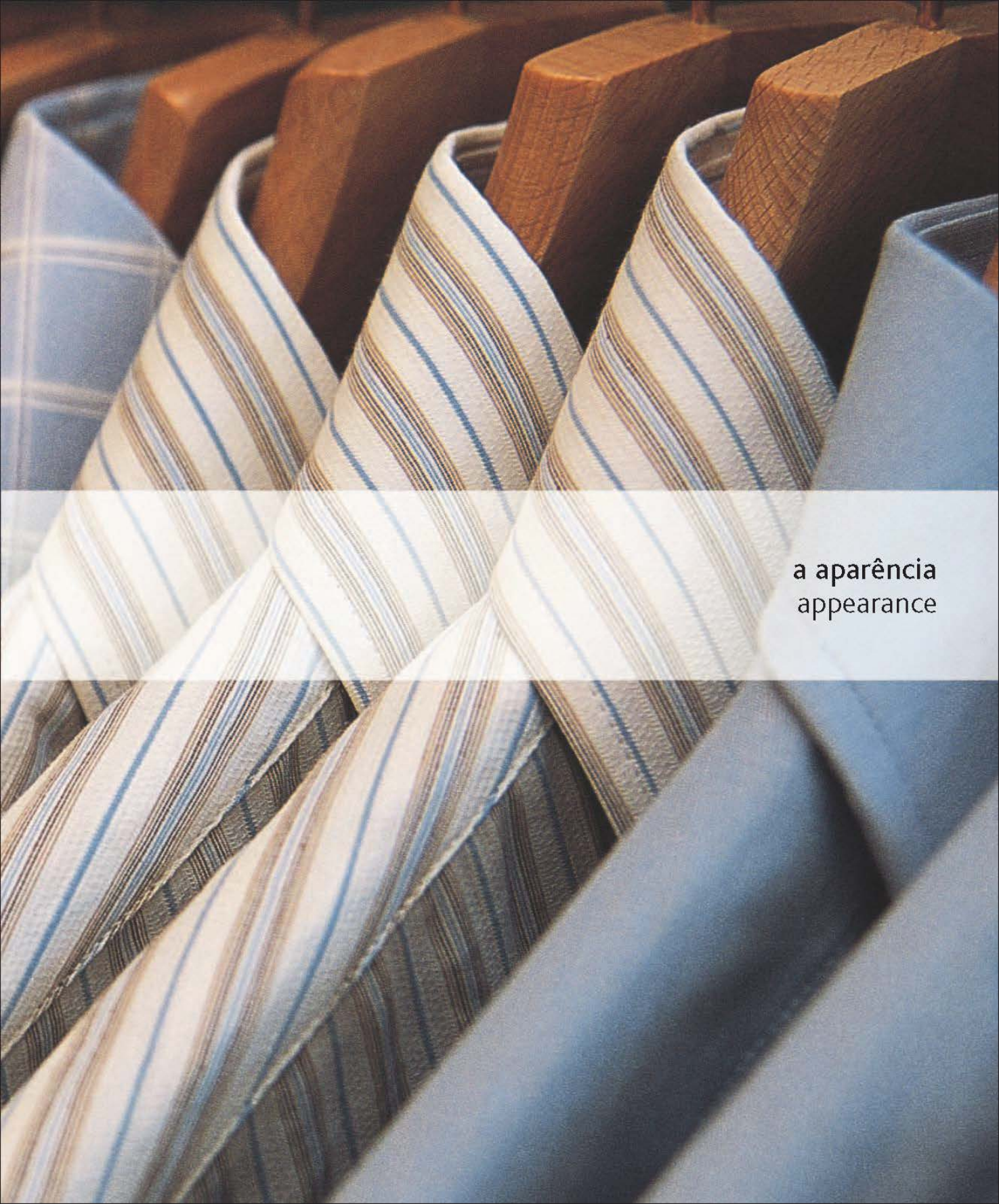

a aparência
appearance

a roupa de criança • children's clothing

o bebé • baby



o body
bodysuit

o babygrow
onesie

a mola
snap



o pijama com pés
sleeper



o fato acolchoado
snowsuit



o macaco sem pernas
romper



o bafeiro
bib



as luvas
mittens



as botinhas
booties



a fralda de turco
cloth diaper



a fralda descartável
disposable diaper



as cuecas de plástico
plastic pants

a criança pequena • toddler



o chapéu de sol
sun hat



o babete com bolso
apron



os calções
shorts

as jardineiras
overalls



a t-shirt
T-shirt



a saia
skirt

a criança • child



o vestido
dress

o capuz
hood

as sandálias
sandals

o Verão
summer



as calças
de ganga
jeans

o impermeável
raincoat



a mochila
backpack

o botão
de alamar
toggle

o Outono
fall



o casaco de baeta
duffel coat



o cachecol
scarf

o anoraque
parka

as botas de
borracha
rain
boots

o Inverno
winter



o roupão
bathrobe

o logótipo
logo

os tênis
athletic shoes

a camisa de noite
nightgown

as pantufas
slippers

a roupa de dormir
nightwear



a roupa da equipa
soccer uniform



o fato de treino
jogging suit



as pernas
leggings

vocabulário • vocabulary

a fibra natural
natural fiber

Pode lavar-se na máquina?
Is it machine-washable?

sintético
synthetic

Isto servirá a uma criança de dois
anos?
Will this fit a two-year-old?

a roupa de homem • men's clothing



vocabulário • vocabulary

a camisa
shirt

o roupão
bathrobe

o fato de treino
jogging suit

comprido
long

o casaco de
malha
cardigan

a roupa interior
underwear

o impermeável
raincoat

curto
short

Tem isto num tamanho acima/abaixo?
Do you have this in a larger/smaller size?

Posso experimentar isto?
May I try this on?



o blazer
blazer



o casaco desportivo
sport coat



o colete
vest

o decote em V
V-neck

o decote redondo
round neck

a t-shirt
T-shirt



as calças de treino
sweatpants

a roupa casual
casual wear



o anoraque
parka



a sweatshirt
sweatshirt



o blusão corta-vento
windbreaker



a camisola de lã
sweater



o pijama
pajamas



a camisola interior
tank top



os calções
shorts



as cuecas
briefs



os boxers
boxer shorts



as peúgas
socks

a roupa de senhora • women's clothing



o vestido de noite
evening dress



o vestido
dress

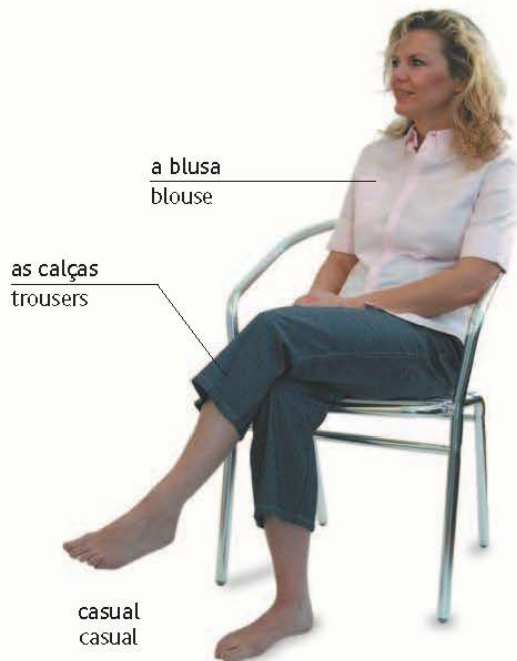

a lingerie • lingerie



o robe
negligée



a combinação
slip



a camisola interior
bra camisole



o espartilho de ligas
bustier

as ligas
garters



as meias de
liga
stockings



as collants
tights

a camisola de
alças
vest



as cuecas
panties



o soutien
bra



a camisa de noite
nightgown

o casamento • wedding



a renda
lace

o véu
veil

o ramo de flores
bouquet

a cauda
train

o vestido de casamento
wedding dress

vocabulário • vocabulary

o espartilho
corset

de corte justo
tailored

a liga
garter

preso no pescoço
halter neck

almofada de
ombro
shoulder pad

com arames
underwired

o cós
waistband

soutien de desporto
sports bra

os acessórios • accessories



o boné
cap



o chapéu
hat



o lenço de pescoço
scarf



a fivela
buckle
o cinto
belt



o cabo
handle
a ponta
tip



o lenço de assoar
handkerchief



o laço
bow tie



o alfinete de gravata
tie clip



as luvas
gloves

o guarda-chuva
umbrella

as jóias • jewelry



o pendente
pendant



o broche
brooch



o botão de punho
cufflink



o elo
link
o fecho
clasp
a pulseira
bracelet



o brinco
earring
o anel
ring
a pedra
stone
o fio
chain



o colar
necklace



o relógio
watch

o guarda-jóias | jewelry box

o colar de pérolas
string of pearls

as malas • bags



a carteira de homem
wallet



a carteira de senhora
change purse



a mala de pôr ao
ombro
shoulder bag

o fecho
fastening

a alça para
ombro
shoulder strap

as asas
handles



o saco de viagem
duffel bag



a pasta
briefcase



a mala de mão
handbag



a mochila
backpack

os sapatos • shoes

a ilhó
eyelet

o atacador
lace

a pala
tongue

a sola
sole

o salto
heel



o sapato de atacador
lace-up



a bota de caminhada
hiking boot



o ténis
athletic shoe



o sapato de cabedal
leather shoe



o chinelo de enfiar no
dedo
flip-flop



o sapato de salto alto
high-heel shoe



o sapato de cunha
platform shoe



a sandália
sandal



o mocassin
slip-on



o sapato de homem
brogue

o cabelo • hair



o pente
comb

pentear (v)
comb (v)



a escova
brush

escovar (v) | brush (v)

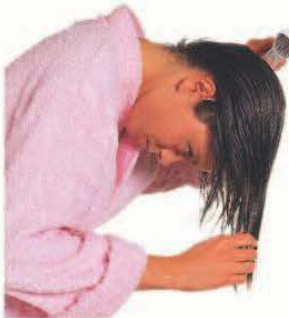

enxaguar (v)
rinse (v)



a cabeleireira
hair stylist

o lavatório
sink

a cliente
client

lavar (v) | wash (v)



a bata
robe

cutar (v)
cut (v)

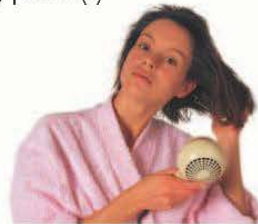

secar com o secador (v)
blow dry (v)



fazer mise (v)
set (v)

os acessórios • accessories



o secador
hairdryer



o champô
shampoo



o amaciador
conditioner



o gel
gel



a laca
hairspray



a tesoura
scissors



a bandolete
hairband

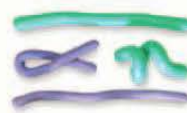

o rolo
curler



o gancho de mola
bobby pin

os penteados • styles



o rabo de cavalo
ponytail

a fita
ribbon



a trança
braid



a banana
French braid



o monho
bun



os rabichos
pigtails



virado para dentro
bob



curto
crop



encaracolado
curly



permanente
perm



liso
straight



os reflexos
highlights

as raízes
roots

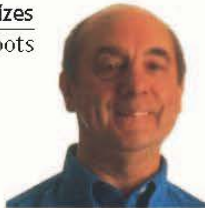

careca
bald



a cabeleira
wig

as cores • colours



loiro
blonde



castanho
brunette



cobre
auburn



ruivo
ginger



preto
black



cinzento
gray



branco
white



pintado
dyed

vocabulário • vocabulary

aparar (v)
trim (v)

oleoso
greasy

alisar (v)
straighten (v)

seco
dry

o barbeiro
barber

normal
normal

a caspa
dandruff

o couro cabeludo
scalp

as pontas espigadas
split ends

o elástico de cabelo
hair tie

a beleza • beauty



a tinta do cabelo
hair dye

a sombra de
olhos
eye shadow

o rímel
mascara

o lápis de olhos
eyeliner

o blush
blusher

a base
foundation

o báton
lipstick

a maquilhagem • makeup



o lápis de sobrancelhas
eyebrow pencil



a escova de sobrancelhas
eyebrow brush



a pinça
tweezers



o brilho para lábios
lip gloss



o pincel para lábios
lip brush



o lápis de contorno
lip liner



o pincel para pó-de-arroz
brush



o lápis corrector
concealer

o espelho
mirror

o pó-de-arroz
face powder

a esponja para
pó-de-arroz
powder puff

a caixa de pó compacto | compact

os tratamentos de beleza • beauty treatments



os artigos de toilette • toiletries



a manicura • manicure



vocabulário • vocabulary

a pele complexion	oleosa oily	o bronzado tan
clara fair	sensível sensitive	a tatuagem tattoo
escura dark	hipoalergénico hypoallergenic	o anti-rugas antiwrinkle
seca dry	a tonalidade shade	as bolas de algodão cotton balls





a saúde
health

a doença • illness



a febre | fever



a dor de cabeça
headache



o sangramento
do nariz
nosebleed



a tosse
cough



o espirro
sneeze



a constipação
cold



a gripe
flu



o inalador
inhaler

a asma
asthma



as cólicas
cramps



a náusea
nausea



a varicela
chickenpox



a erupção
rash

vocabulário • vocabulary

o AVC
stroke

a diabetes
diabetes

a eczema
eczema

o resfriado
chill

vomitir (v)
vomit (v)

a diarreia
diarrhea

a tensão arterial
blood pressure

a alergia
allergy

a infecção
infection

a dor de estômago
stomach ache

a epilepsia
epilepsy

o sarampo
measles

o enfarte do
miocárdio
heart attack

a febre dos
fenos
hayfever

o vírus
virus

desmaiar (v)
faint (v)

a enxaqueca
migraine

a papeira
mumps

o médico • doctor
a consulta • office visit

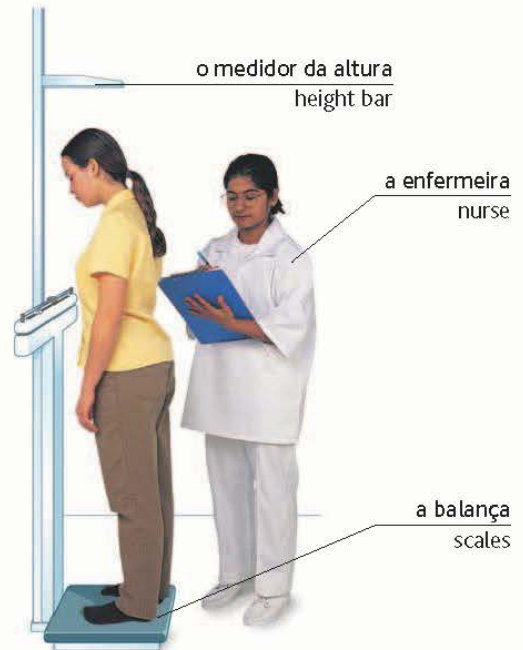
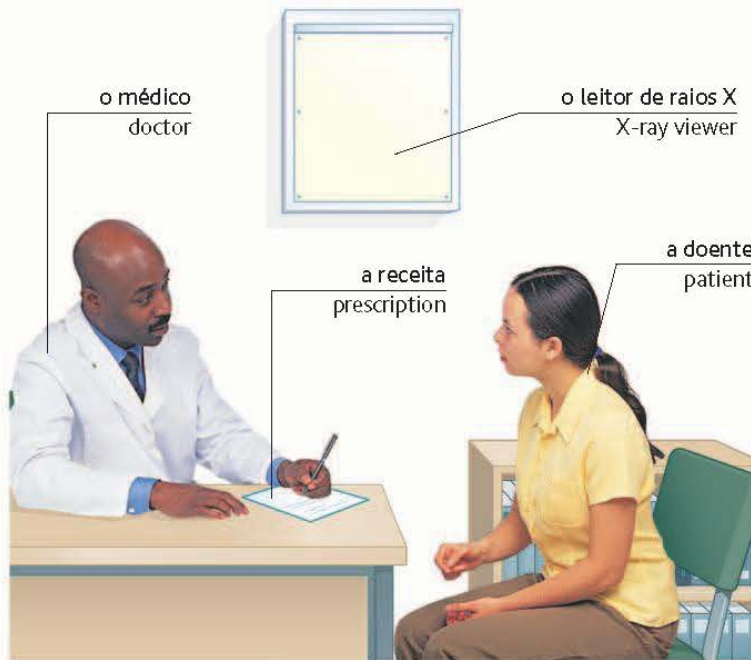

o medidor de tensão arterial
blood pressure gauge

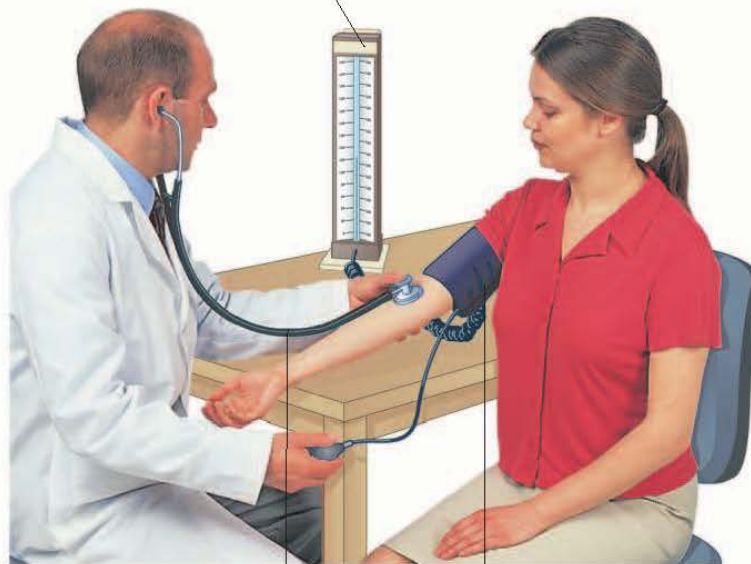

vocabulário • vocabulary

a consulta
appointment

a vacina
inoculation

o consultório
surgery

o termómetro
thermometer

a sala de espera
waiting room

o exame médico
medical examination

Preciso de uma consulta.
I need to see a doctor.

Dói-me aqui.
It hurts here.

a lesão • injury



a entorse | sprain

a ligadura triangular de suporte
sling



a fractura
fracture

o colar cervical
neck brace



a distensão cervical
whiplash



o corte
cut



o arranhão
graze



o hematoma
bruise



a farpa
splinter



a queimadura solar
sunburn



a queimadura
burn



a mordedura
bite



a picada
sting

vocabulário • vocabulary

o acidente
accident

a hemorragia
haemorrhage

o envenenamento
poisoning

Ele/ela vai ficar bem?
Will he/she be all right?

a emergência
emergency

a bolha
blister

o choque eléctrico
electric shock

Onde é que lhe dói?
Where does it hurt?

a ferida
wound

a concussão
concussion

o ferimento na cabeça
head injury

Por favor chame uma ambulância.
Please call an ambulance.

os primeiros socorros • first aid

a pomada
ointment

o penso rápido
adhesive
bandages

o alfinete de
segurança
safety pin

a ligadura
bandage

os analgésicos
painkillers



a toalhita
anti-séptica
antiseptic wipe

a pinça
tweezers

a tesoura
scissors

o anti-séptico
antiseptic

a caixa de primeiros socorros | first aid kit

a gaze
gauze



o curativo
dressing



a tala | splint



o adesivo
adhesive tape



a reanimação
resuscitation

vocabulário • vocabulary

o choque
shock

o pulso
pulse

engasgar-se (v)
choke (v)

Pode ajudar-me?
Can you help?

inconsciente
unconscious

a respiração
breathing

estéril
sterile

Tem conhecimentos de
primeiros socorros?
Do you know first aid?

o hospital • hospital



a análise de sangue
blood test



a injeção
injection

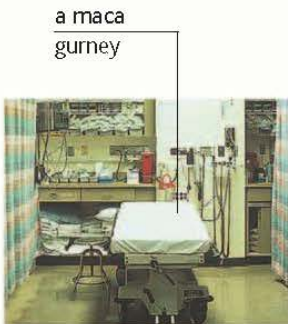

a maca
gurney

a sala de urgências
emergency room

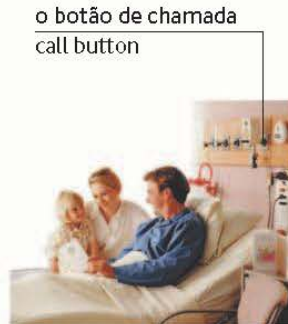

o botão de chamada
call button

a enfermaria
hospital room



a cadeira de rodas
wheelchair



a radiografia
X-ray

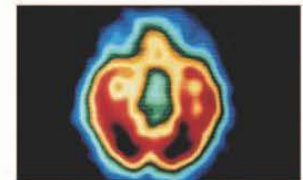

a ecografia
scan

vocabulário • vocabulary

a operação
operation

com alta
discharged

as horas de visita
visiting hours

a enfermaria da
pediatria
children's ward

a unidade de cuidados
intensivos
intensive care unit

internado
admitted

a clínica
clinic

a enfermaria da
maternidade
maternity ward

o quarto particular
private room

o doente externo
outpatient

os serviços • departments



a otorrinolaringologia
ear, nose, and throat (ENT)



a cardiologia
cardiology



a ortopedia
orthopedics



a ginecologia
gynecology



a fisioterapia
physiotherapy



a dermatologia
dermatology



a pediatria
pediatrics



a radiologia
radiology



a cirurgia
surgery



a maternidade
maternity



a psiquiatria
psychiatry



a oftalmologia
ophthalmology

vocabulário • vocabulary

a neurologia
neurology

a urologia
urology

a endocrinologia
endocrinology

a patologia
pathology

o resultado
result

a oncologia
oncology

a cirurgia plástica
plastic surgery

o encaminhamento
referral

a análise
test

o especialista
consultant

o dentista • dentist

o dente • tooth

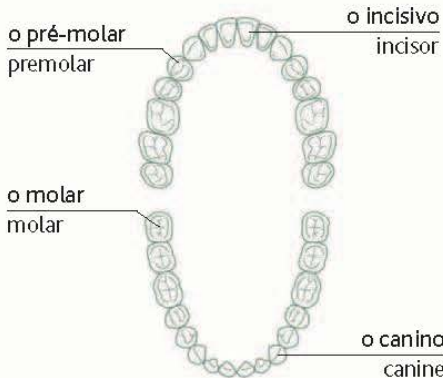
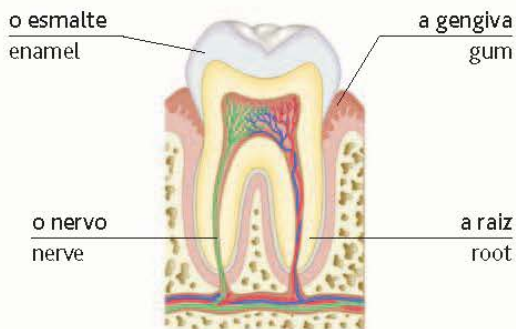

o checkup • checkup

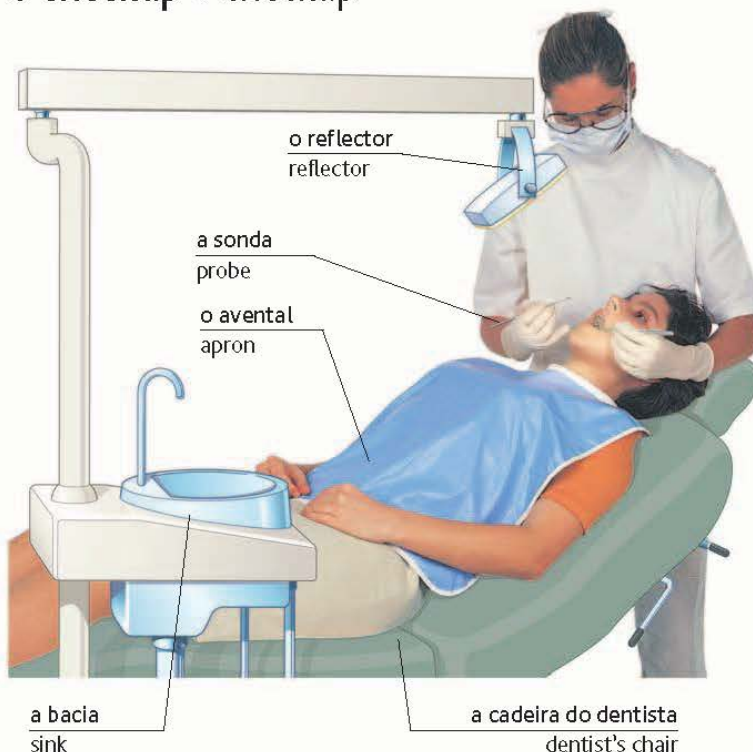

vocabulário • vocabulary

a dor de dentes
toothache

a broca
drill

a placa bacteriana
plaque

o fio dentário
dental floss

a cárie
decay

a extração
extraction

a obturação
filling

a coroa dentária
crown



usar o fio
dentário (v)
floss (v)



a escova
brush



o aparelho
ortodôntico
braces



os raios x dentários
dental X-ray



a radiografia
X-ray film



a dentadura postiça
dentures

o oculista • optician



o exame dos olhos | eye test

o estojo
case



os óculos
glasses

a lente
lens



os óculos de sol
sunglasses

a armação
frame

o líquido de limpeza
cleaning fluid



a solução
desinfectante
disinfectant solution

o estojo das
lentes
lens case



as lentes de contacto | contact lenses

o olho • eye

a sobrancelha
eyebrow

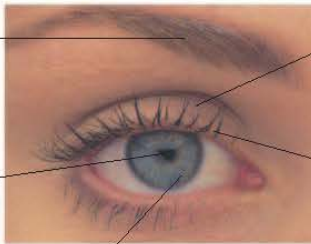

a pálpebra
eyelid

a pupila
pupil

a pestana
eyelash

a íris
iris

a retina
retina

o cristalino
lens

o nervo óptico
optic nerve

a córnea
cornea

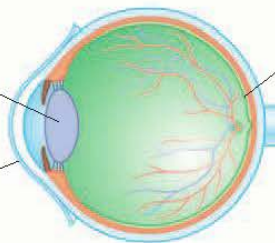

vocabulário • vocabulary

a visão
vision

o astigmatismo
astigmatism

a diopetria
diopter

a hipermetropia
far-sightedness

a lágrima
tear

a miopia
near-sightedness

a catarata
cataract

bifocal
bifocal

a gravidez • pregnancy



a enfermeira
nurse

o teste de gravidez
pregnancy test

a ecografia
scan

o ultra-som | ultrasound

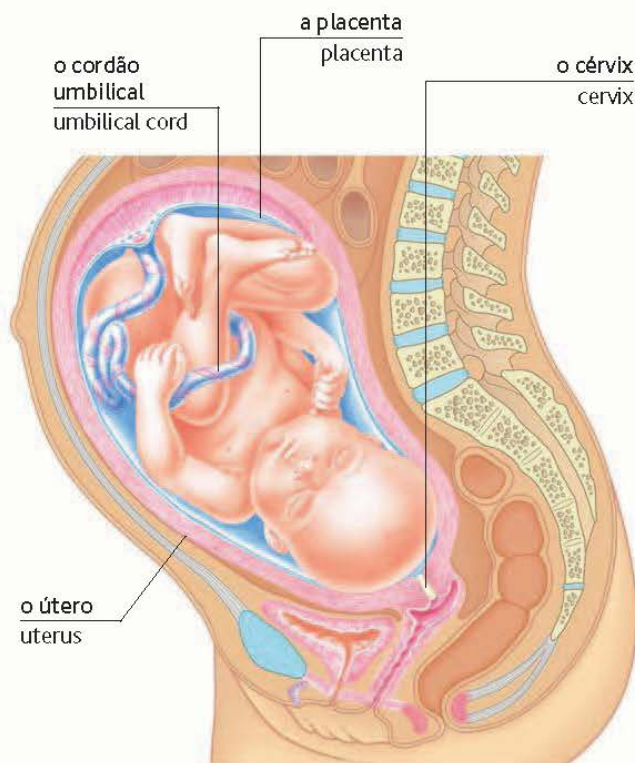

o cordão
umbilical
umbilical cord

a placenta
placenta

o cérvix
cervix

o útero
uterus

o feto | fetus

vocabulário • vocabulary

a ovulação
ovulation

pré-natal
prenatal

a amniocentese
amniocentesis

a dilatação
dilatation

o parto
delivery

distóxico
breach

a concepção
conception

o embrião
embryo

a contracção
contraction

a epidural
epidural

o nascimento
birth

premature
premature

grávida
pregnant

o útero
womb

romper águas (v)
break waters (v)

a episiotomia
episiotomy

o aborto
espontâneo
miscarriage

o ginecologista
gynecologist

gestante
expectant

o trimestre
trimester

o líquido amniótico
amniotic fluid

a cesariana
caesarean section

os pontos
stitches

o obstetra
obstetrician

o parto • childbirth

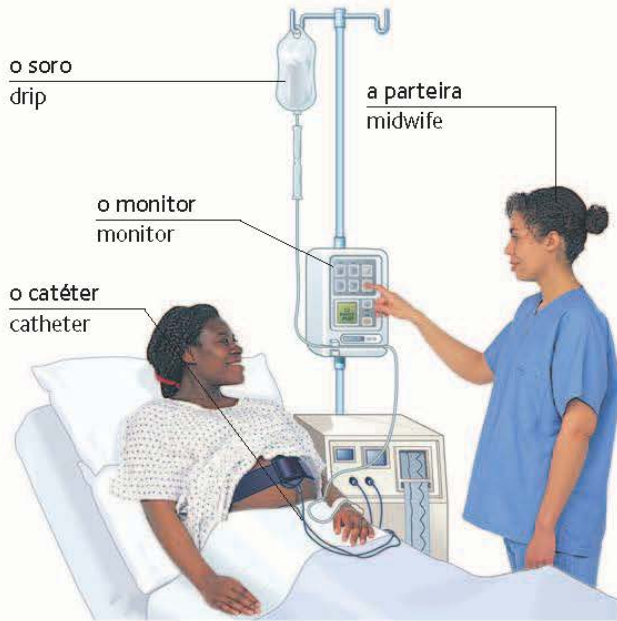

provocar o parto (v)
induce labor (v)



a incubadora | incubator



a balança
scales

o peso à nascença | birth weight

os fórceps
forceps



a ventosa
suction cup

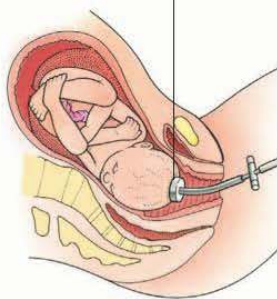

o parto assistido
assisted delivery

a pulseira de identificação
identity tag



o recém-nascido | newborn baby

a amamentação • nursing



a bomba de leite materno
breast pump



o soutien de amamentação
nursing bra



amamentar (v)
breastfeed (v)



os discos protectores
pads

as terapias alternativas • alternative therapy

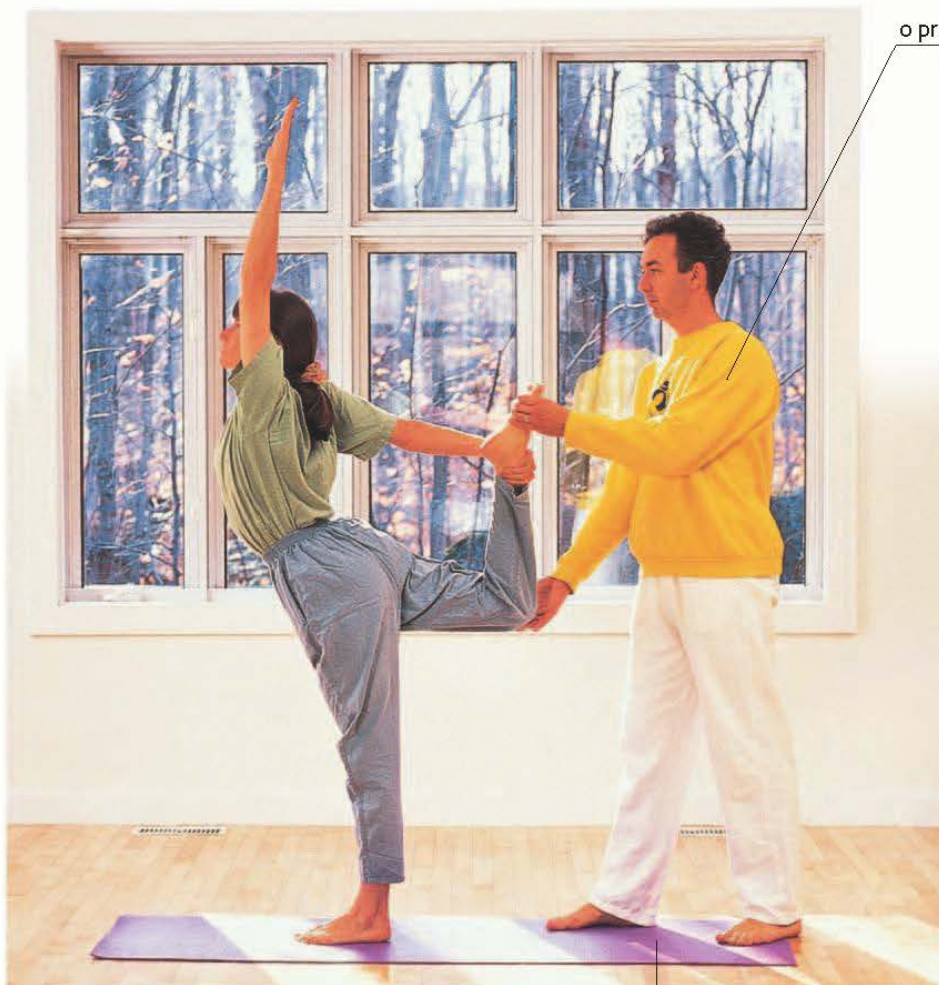

o ioga | yoga

o tapete
mat

o professor
teacher

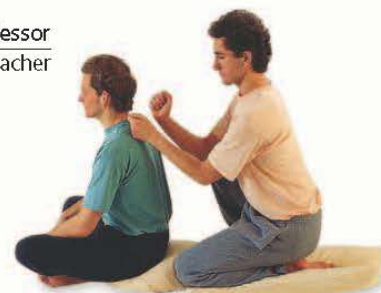

a massagem
massage



o shiatsu
shiatsu



a meditação
meditation



a quiroprática
chiropractic



a osteopatia
osteopathy



a reflexologia
reflexology

o terapeuta
counselor



a terapia de grupo
group therapy



o reiki
reiki



a acupunctura
acupuncture

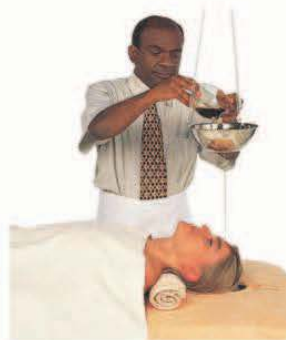

a ayurveda
ayurveda



a hipnoterapia
hypnotherapy

os óleos essenciais
essential oils



a fitoterapia
herbalism



a aromaterapia
aromatherapy



a homeopatia
homeopathy



a acupressão
acupressure

a terapeuta
therapist



a psicoterapia
psychotherapy

vocabulário • vocabulary

o suplemento
supplement

a naturopatia
naturopathy

o relaxamento
relaxation

a erva
herb

a hidroterapia
hydrotherapy

o feng shui
feng shui

o stress
stress

a cristaloterapia
crystal healing

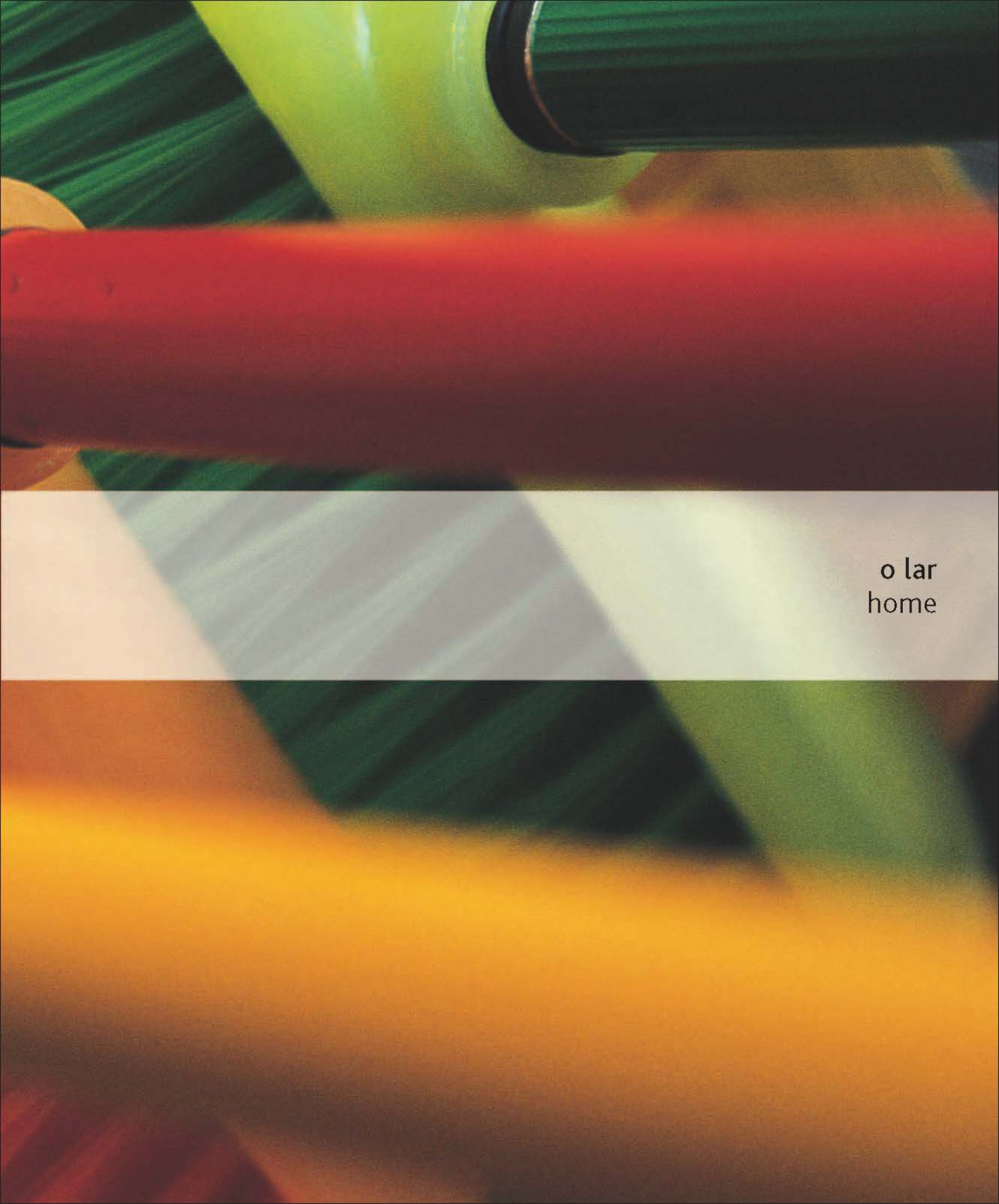

The image features a white horizontal band across the middle. Above and below this band are abstract, blurred shapes in shades of green, red, and yellow. The text 'o lar' and 'home' is positioned on the right side of the white band.

o lar
home

a casa • house

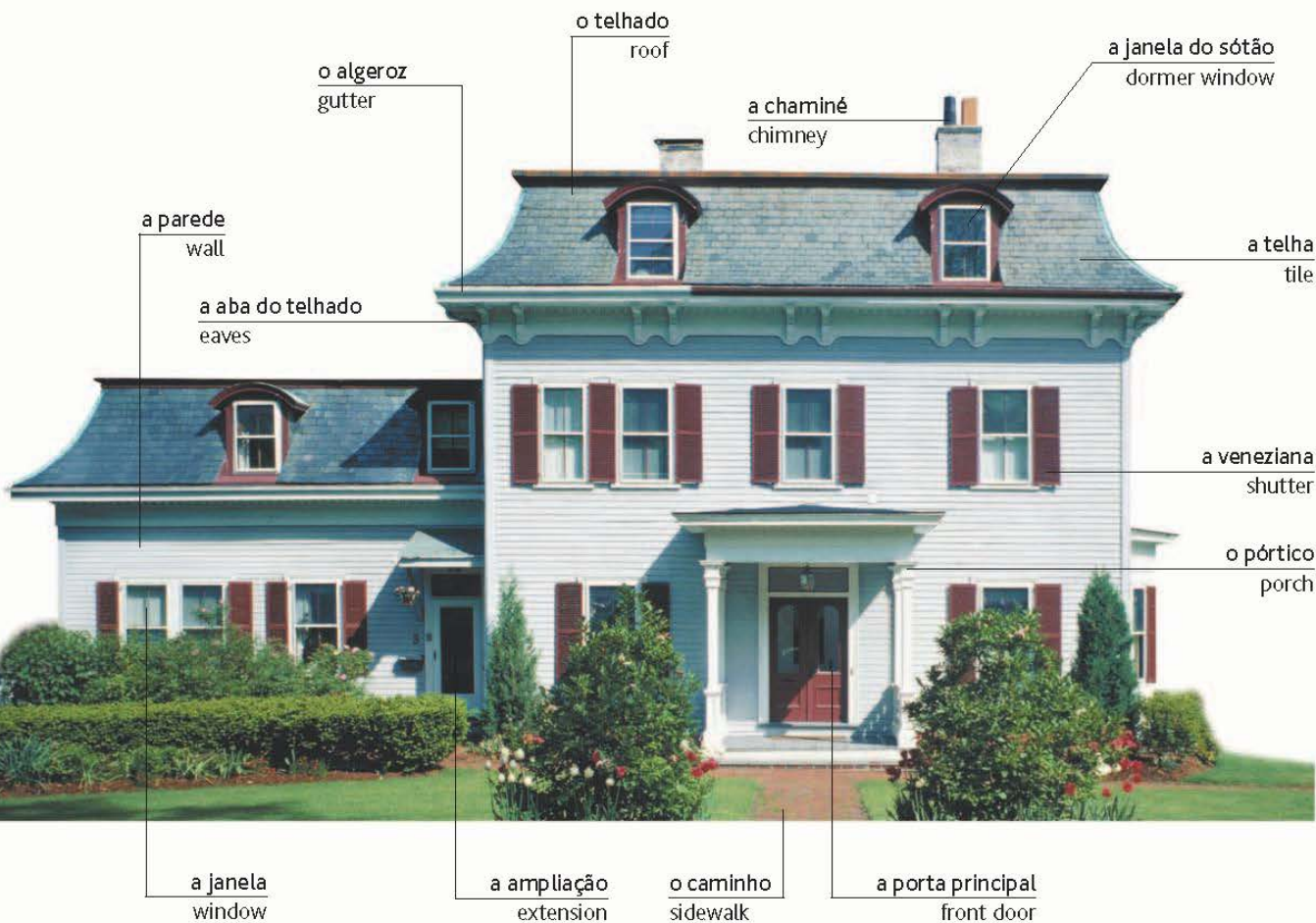

vocabulário • vocabulary

isolada
single-family

o inquilino
tenant

a garagem
garage

a caixa do correio
mailbox

o alarme anti-roubo
burglar alarm

arrendar (v)
rent (v)

geminada
two-family

o bangaló
bungalow

o sótão
attic

a luz da entrada
porch light

o pátio
courtyard

a renda
rent

a moradia urbana
townhouse

a cave
basement

a divisão
room

o senhorio
landlord

o soalho
floor

em banda
rowhouse

a entrada • entrance



o corrimão
hand rail

as escadas
staircase

o patamar
landing

o balaústre
banister

o vestíbulo
hallway



a campainha
doorbell



o capacho
doormat



o batente
door knocker



a corrente
door chain

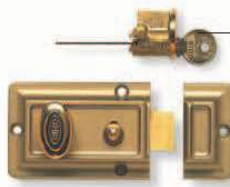

a fechadura
lock



o ferrolho
bolt

a chave
key

o apartamento
• apartment

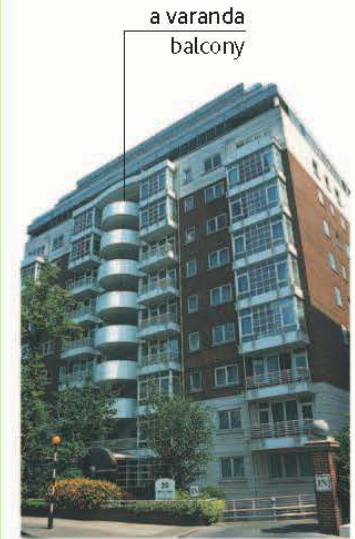

a varanda
balcony

o bloco de apartamentos
apartment building



o intercomunicador
intercom

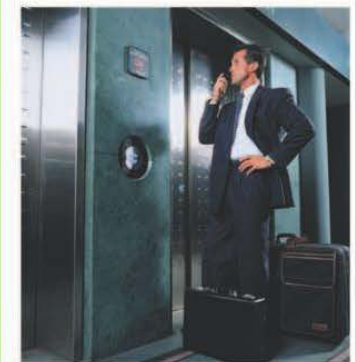

o elevador
elevator

as instalações internas • internal systems



o radiador
radiator



o aquecedor
space heater



a palheta
blade

a ventoinha
fan



o convector
portable heater

a electricidade • electricity



o filamento
filament

o casquilho de baioneta
thread

a lâmpada | light bulb

a ligação à terra
ground prong

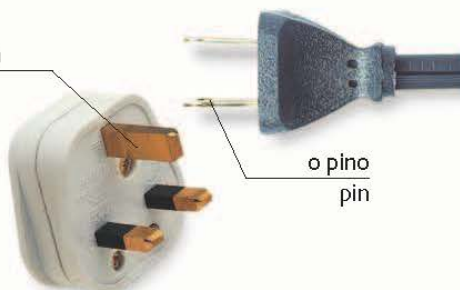

a ficha | plug

o pino
pin

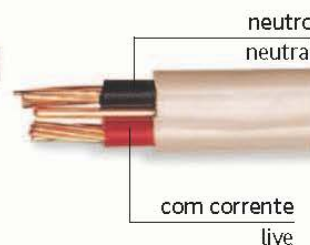

neutro
neutral

com corrente
live

os cabos | wires

vocabulário • vocabulary

a tensão
voltage

o fusível
fuse

a tomada
socket

a corrente contínua
direct current (DC)

o corte de
corrente
power outage

amp
o ampere

a caixa dos fusíveis
fuse box

o interruptor
switch

o transformador
transformer

o fornecimento
de electricidade
domestic supply

a corrente
eléctrica
power

o gerador
generator

a corrente alterna
alternating current (AC)

o contador da
electricidade
electricity meter

a canalização • plumbing

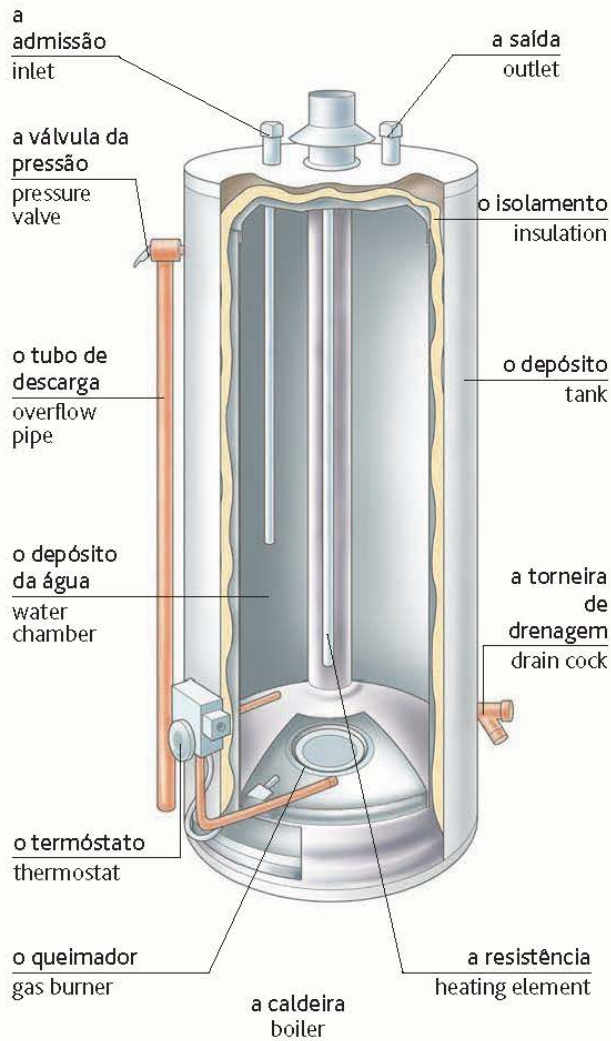

o lava-loiças • sink

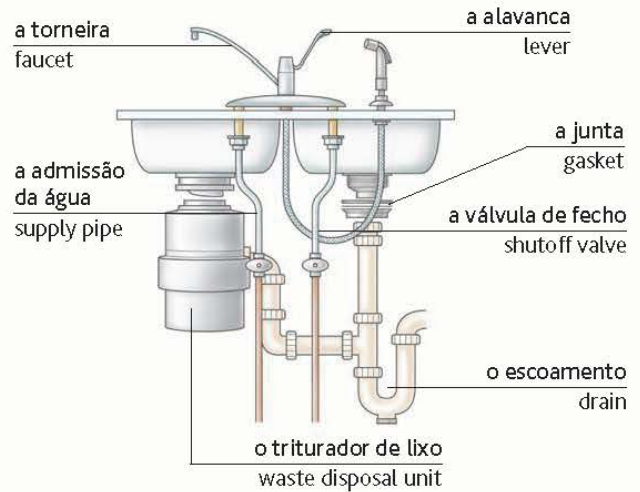

a sanita • toilet

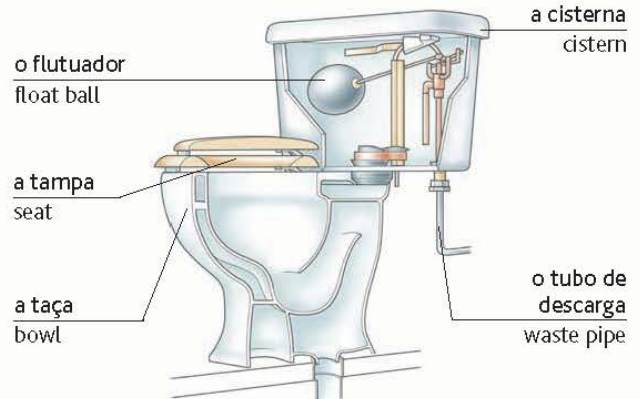

a eliminação de resíduos • waste disposal



a sala de estar • living room



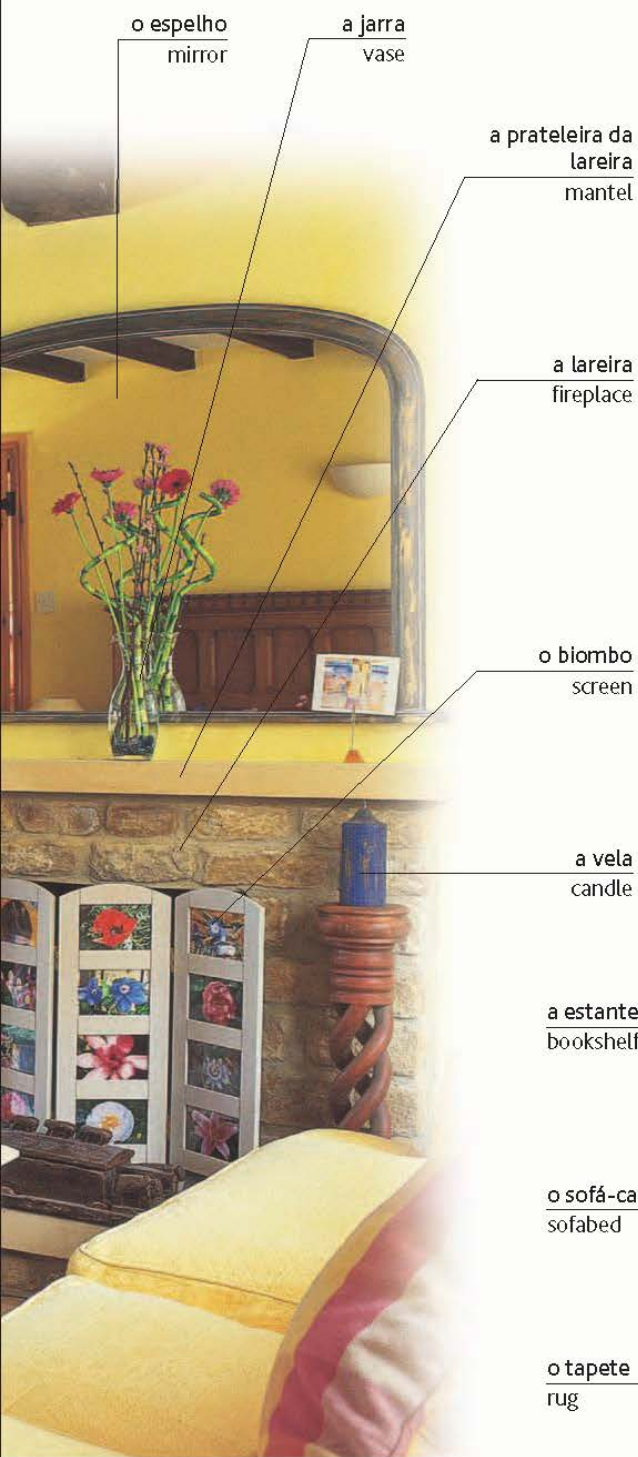

a cortina
curtain



a cortina de rede
sheer curtain



o estore veneziano
venetian blind



o estore com rolo
window shade

o friso
molding

a poltrona
armchair



o escritório | study

a sala de jantar • dining room



vocabulário • vocabulary

pôr a mesa (v)
set the table (v)

faminto
hungry

o almoço
lunch

cheio
full

o anfitrião
host

Posso repetir, por favor?
Can I have some more, please?

servir (v)
serve (v)

a toalha de
mesa
tablecloth

o jantar
dinner

a dose
portion

a anfitriã
hostess

Estou satisfeito, obrigado.
I've had enough, thank you.

comer (v)
eat (v)

o pequeno-
almoço
breakfast

o individual
placemat

a refeição
meal

o convidado
guest

Estava delicioso.
That was delicious.

a louça e os talheres • crockery and flatware



a caneca
mug



a chávena de café
coffee cup



a chávena de chá
teacup

a colher de chá
teaspoon



o prato
plate



a taça
bowl



a cafeteira
cafetière



o bule
teapot



o jarro
pitcher



o ovoiro
egg cup

o copo de vinho
wine glass

o copo de água
tumbler



os vidros
glassware

a argola de
guardanapo
napkin ring

o prato
de pão
side plate

o prato raso
dinner plate

o prato de sopa
soup bowl

a colher de sopa
soup spoon



o guardanapo
napkin



o garfo
fork



o lugar
place setting



a colher
spoon

a faca
knife

a cozinha • kitchen



os electrodomésticos • appliances



a máquina de
cubos de gelo
icemaker

o congelador
freezer



o frigorífico
refrigerator

a prateleira
shelf

a caixa dos
legumes
crisper

o frigorífico-congelador | side-by-side refrigerator

vocabulário • vocabulary

o escorredor
draining board

congelar (v)
freeze (v)

o queimador
burner

descongelar (v)
defrost (v)

o fogão
stovetop

cozer ao
vapor (v)
steam (v)

o caixote do lixo
garbage can

saltear (v)
sauté (v)

cozinhar • cooking



pelar (v)
peel (v)



cortar (v)
slice (v)



ralar (v)
grate (v)



deitar (v)
pour (v)



misturar (v)
mix (v)



bater (v)
whisk (v)



ferver (v)
boil (v)



fritar (v)
fry (v)



estender com o rolo (v)
roll (v)



mexer (v)
stir (v)



cozer em fogo
lento (v)
simmer (v)



escalfar (v)
poach (v)



cozer no forno (v)
bake (v)



assar (v)
roast (v)



grelhar (v)
grill (v)

os utensílios de cozinha • kitchenware



a tábua para cortar
chopping board

a faca de pão
bread knife



a faca de cozinha
kitchen knife



o cutelo
cleaver



o afiador de facas
knife sharpener



o martelo de carne
meat tenderizer



o espeto
skewer



o ralador
grater



o almofariz
mortar

o pilão
pestle



o esmagador
de batata
masher



o pelador
peeler



o descaroçador de
maças
apple corer



o abre-latas
can opener



o tira-cápsulas
bottle opener



o esmagador de
alhos
garlic press



a colher de servir
serving spoon



a espátula de peixe
food turner



o coador
colander



a espátula
spatula



a colher de pau
wooden spoon



a colher perfurada
slotted spoon



a concha
ladle



o garfo de trinchar
carving fork



a colher para gelado
scoop



o batedor de arames
whisk



o passador
strainer



a pastelaria • baking cakes



o quarto de dormir • bedroom

o guarda-fatos
wardrobe

o candeeiro de
mesa-de-
cabeceira
bedside lamp

a cabeceira
headboard

a mesa-de-cabeceira
bedside table

a cómoda
chest of drawers



a gaveta
drawer

a cama
bed

o colchão
mattress

a colcha
bedspread

a almofada
pillow



o saco de água
quente
hot-water bottle



o rádio despertador
clock radio



o relógio despertador
alarm clock



a caixa de lenços de
papel
box of tissues



o cabide
coat hanger

a roupa de cama • bed linen



o espelho
mirror

o toucador
dressing table

o soalho
floor



a fronha
pillowcase

o lençol
sheet

o rodapé da cama
dust ruffle

o edredão
comforter

a coberta acolchoada
quilt

o cobertor
blanket



vocabulário • vocabulary

a cama de solteiro
twin bed

os pés da cama
footboard

a insónia
insomnia

acordar (v)
wake up (v)

pôr o despertador
para tocar (v)
set the alarm (v)

a cama de casal
full bed

a mola
spring

deitar-se (v)
go to bed (v)

levantar-se (v)
get up (v)

ressonar (v)
snore (v)

o cobertor eléctrico
electric blanket

a alcatifa
carpet

ir dormir (v)
go to sleep (v)

fazer a cama (v)
make the bed (v)

o roupeiro embutido
closet

a casa de banho • bathroom

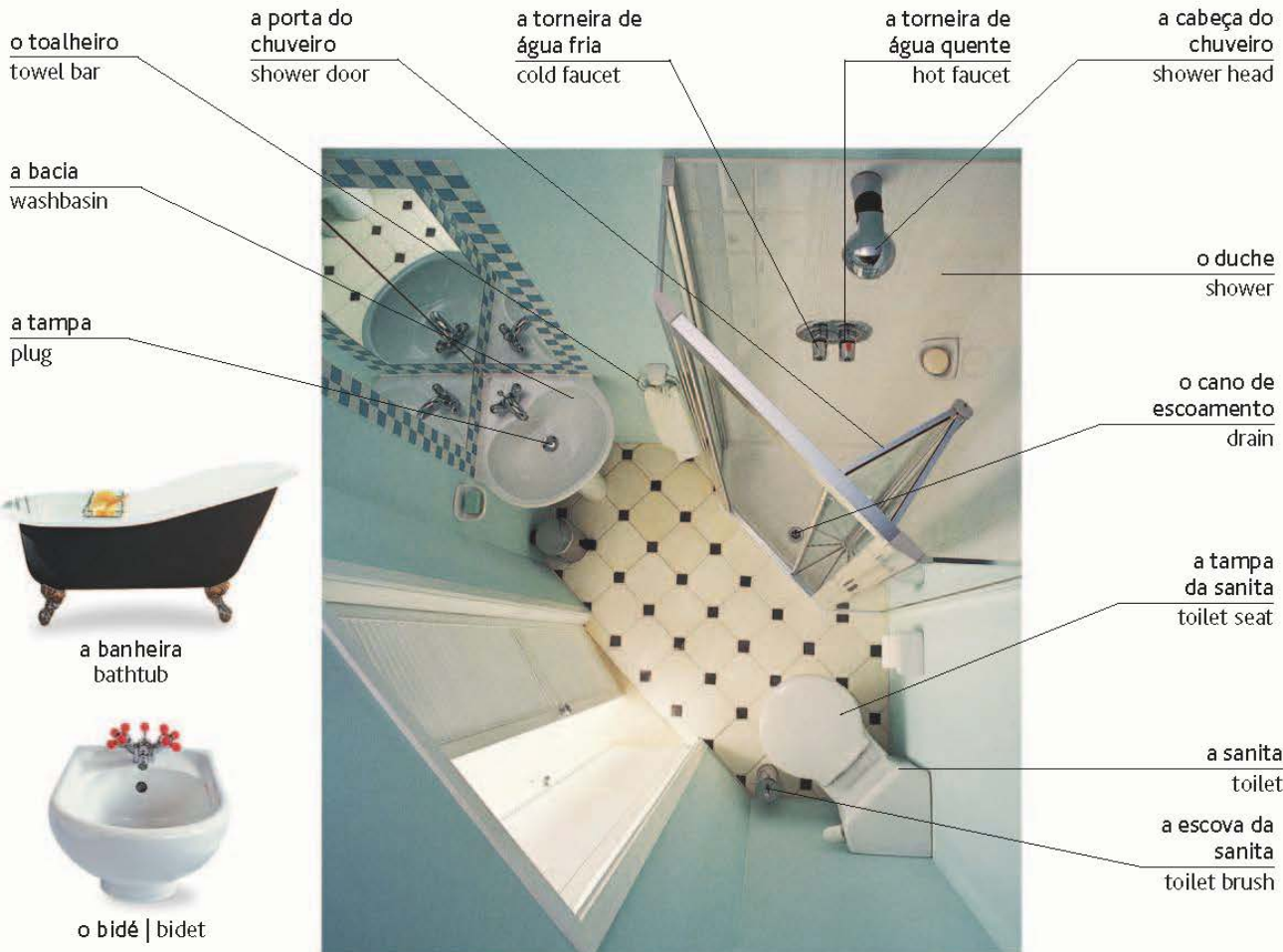

vocabulário • vocabulary

o armário de medicamentos
medicine cabinet

o tapete de banheira
bath mat

o rolo de papel higiénico
toilet paper

a cortina do chuveiro
shower curtain

tomar um duche (v)
take a shower (v)

tomar um banho (v)
take a bath (v)

a higiene dental • dental hygiene



a escova de dentes
toothbrush



o fio dentário
dental floss



a pasta de dentes
toothpaste



o elixir bucal
mouthwash



a lufa
loofah

a esponja
sponge



a pedra-pomes
pumice stone



a escova para as costas
back brush



o desodorizante
deodorant

a saboneteira
soap dish



o sabonete
soap

o gel de duche
shower gel



o creme para a cara
face cream



o gel de banho
bubble bath



o roupão de banho
bathrobe

a toalha
de mãos
hand towel



as toalhas
towels

a toalha de
banho
bath towel



a loção de corpo
body lotion



o pó de talco
talcum powder

a barba • shaving

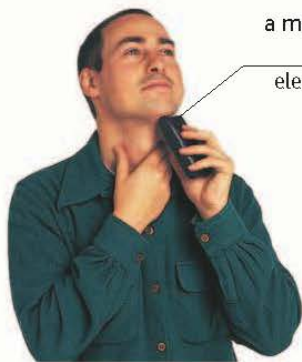

a máquina de
barbear
electric razor



a espuma de barbear
shaving foam



a gilete descartável
disposable razor



a lâmina de
barbear
razor blade



o aftershave
aftershave

o quarto das crianças • nursery

o cuidado do bebé • baby care



a esponja
sponge

o creme para as
assaduras
diaper rash cream

a toalhita
húmida
wet wipe

a banheira do bebé
baby bath

o bacio
potty

o muda-fraldas
changing mat

a hora de dormir • sleeping

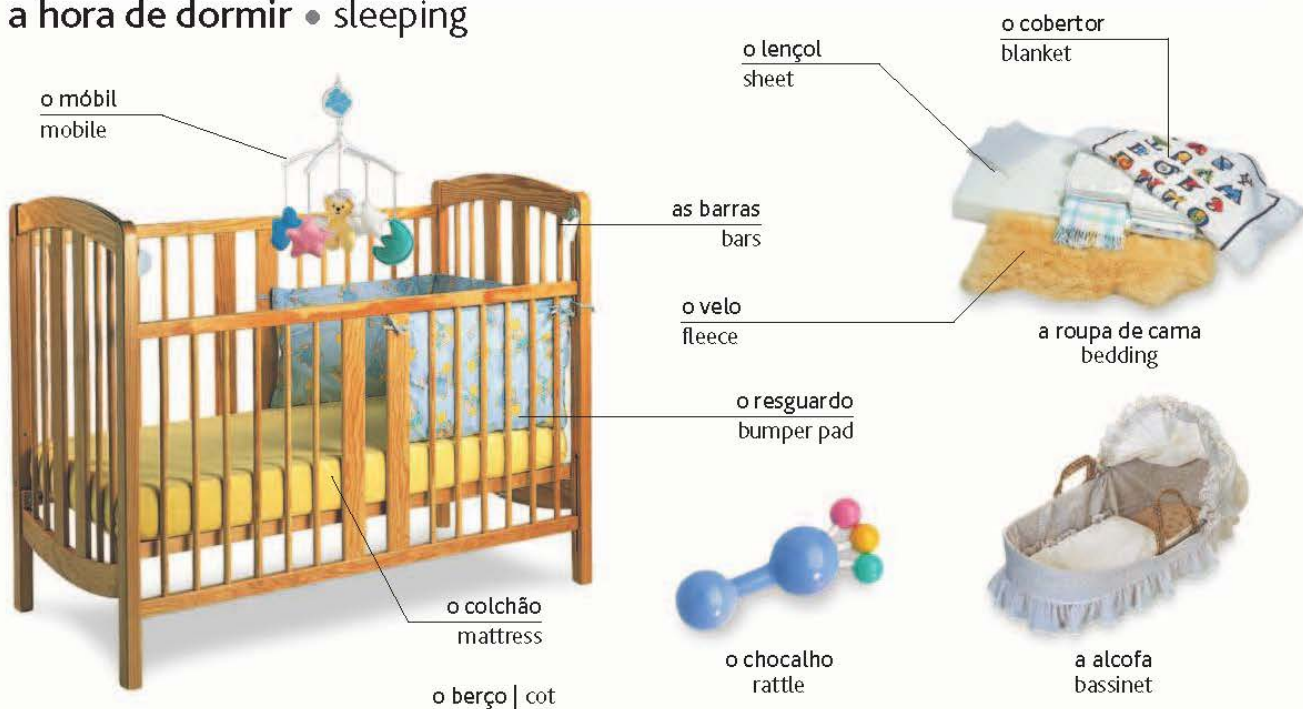

o móbil
mobile

o lençol
sheet

o cobertor
blanket

as barras
bars

o velo
fleece

a roupa de cama
bedding

o resguardo
bumper pad

o colchão
mattress

o berço | cot

o chocalho
rattle

a alcova
bassinet

os jogos • playing

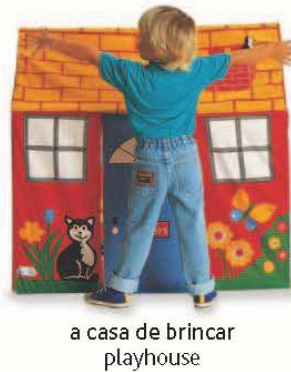
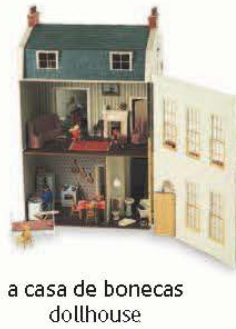

a segurança • safety



a comida • eating



o passeio • going out

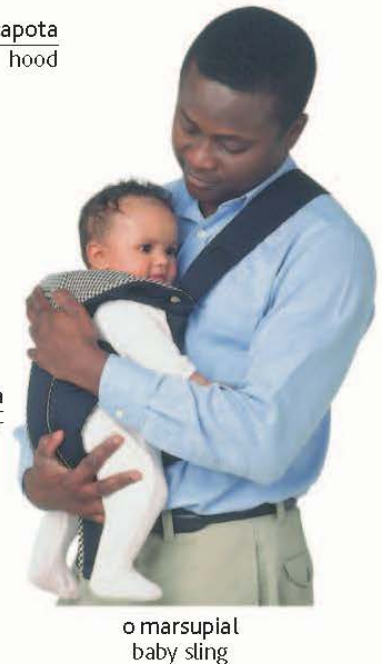

a lavanderia • utility room

o tratamento da roupa • laundry

a roupa suja
dirty laundry



o cesto da roupa suja
laundry basket



a máquina de lavar
roupa
washing machine



a máquina de lavar e
secar roupa
washer-dryer



a máquina de secar
roupa
tumble dryer

a roupa limpa
clean clothes



o cesto da roupa
para engomar
laundry basket

a mola da roupa
clothes pin



secar (v)
dry (v)

a corda da roupa
clothesline



a tábua de engomar | ironing board



o ferro
iron

vocabulário • vocabulary

pôr a roupa na
máquina (v)
load (v)

centrifugar (v)
spin (v)

engomar (v)
iron (v)

Como funciona a máquina de lavar?
How do I operate the washing machine?

enxaguar (v)
rinse (v)

a centrifugadora
spin dryer

o amaciador de
roupa
fabric softener

Qual é o programa para a roupa de cor/branca?
What is the setting for colors/whites?

o equipamento de limpeza • cleaning equipment



as acções • activities

limpar (v)
clean (v)lavar (v)
wash (v)passar um pano (v)
wipe (v)esfregar (v)
scrub (v)raspar (v)
scrape (v)a vassoura
broomvarrer (v)
sweep (v)limpar o pó (v)
dust (v)dar brilho (v)
polish (v)

a oficina • workshop

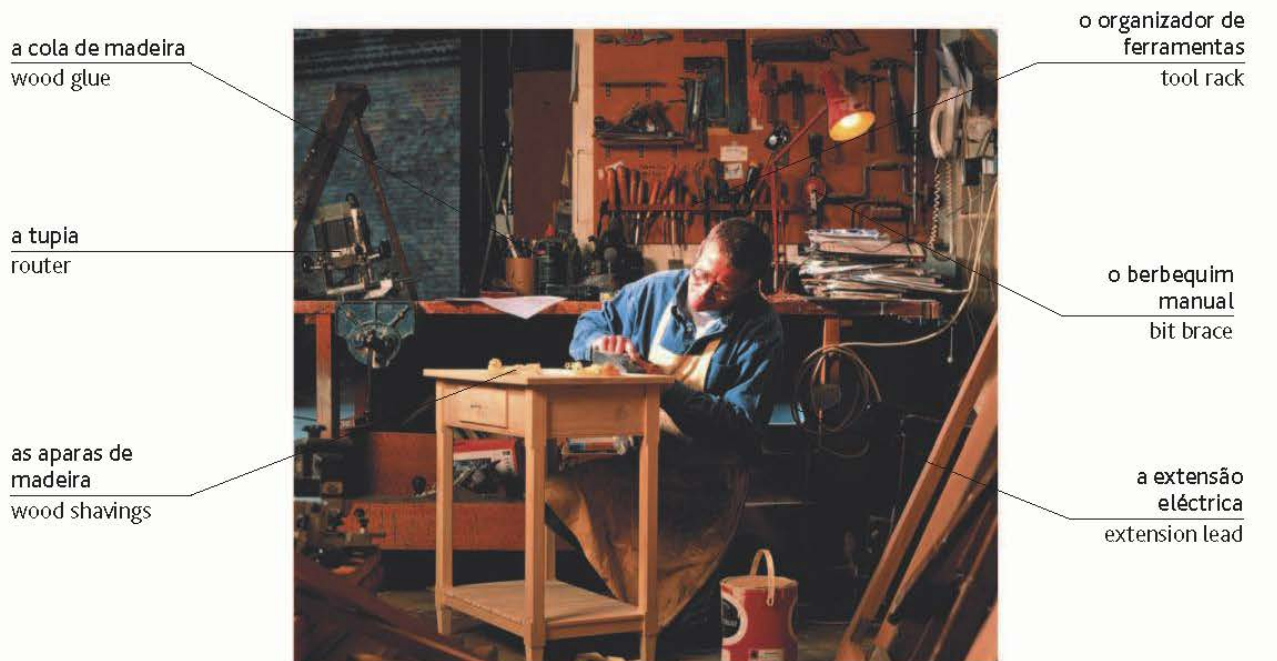

as técnicas • techniques

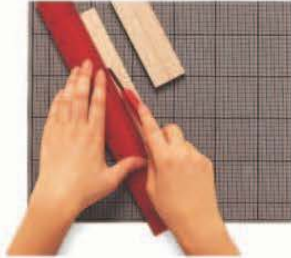

cortar (v)
cut (v)



serrar (v)
saw (v)



furar (v)
drill (v)



martelar (v)
hammer (v)



aplinar (v) | plane (v)



tornear (v) | turn (v)

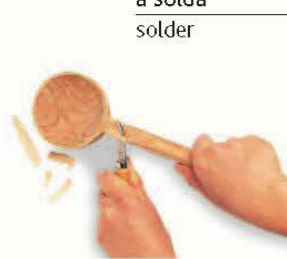

talhar (v) | carve (v)

a solda
solder

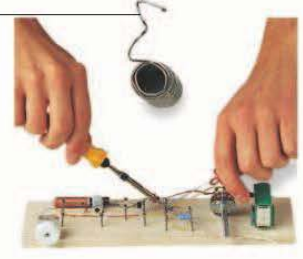

soldar (v) | solder (v)

os materiais • materials

a fibra de média densidade (MDF)
fiberboard (MDF)

o contraplacado
plywood

o aglomerado
chipboard

o cartão
prensado
hardboard

a madeira
macia
softwood



a madeira | wood

a madeira dura
hardwood

o arame
wire

o verniz
varnish

o corante de
madeiras
wood stain

o cabo
cable

o aço inoxidável
stainless steel

galvanizado
galvanized

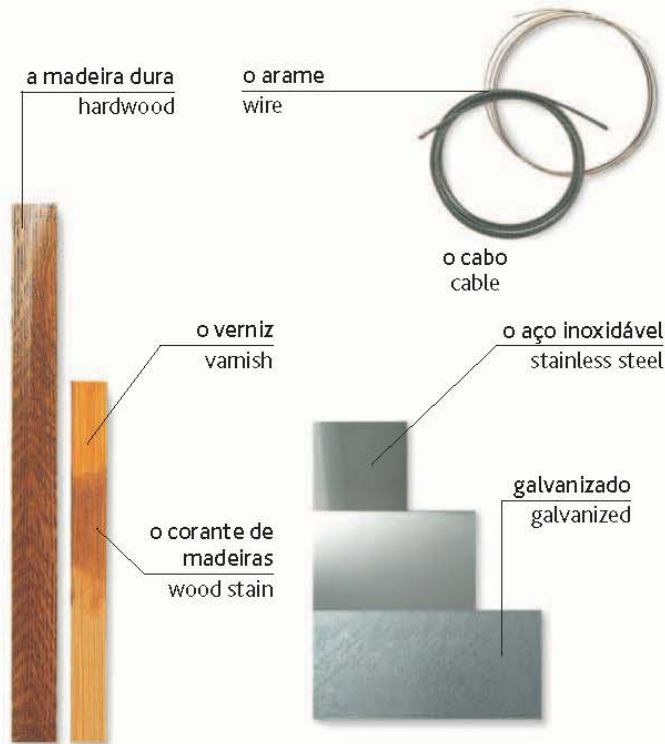

o metal | metal

a caixa das ferramentas • toolbox

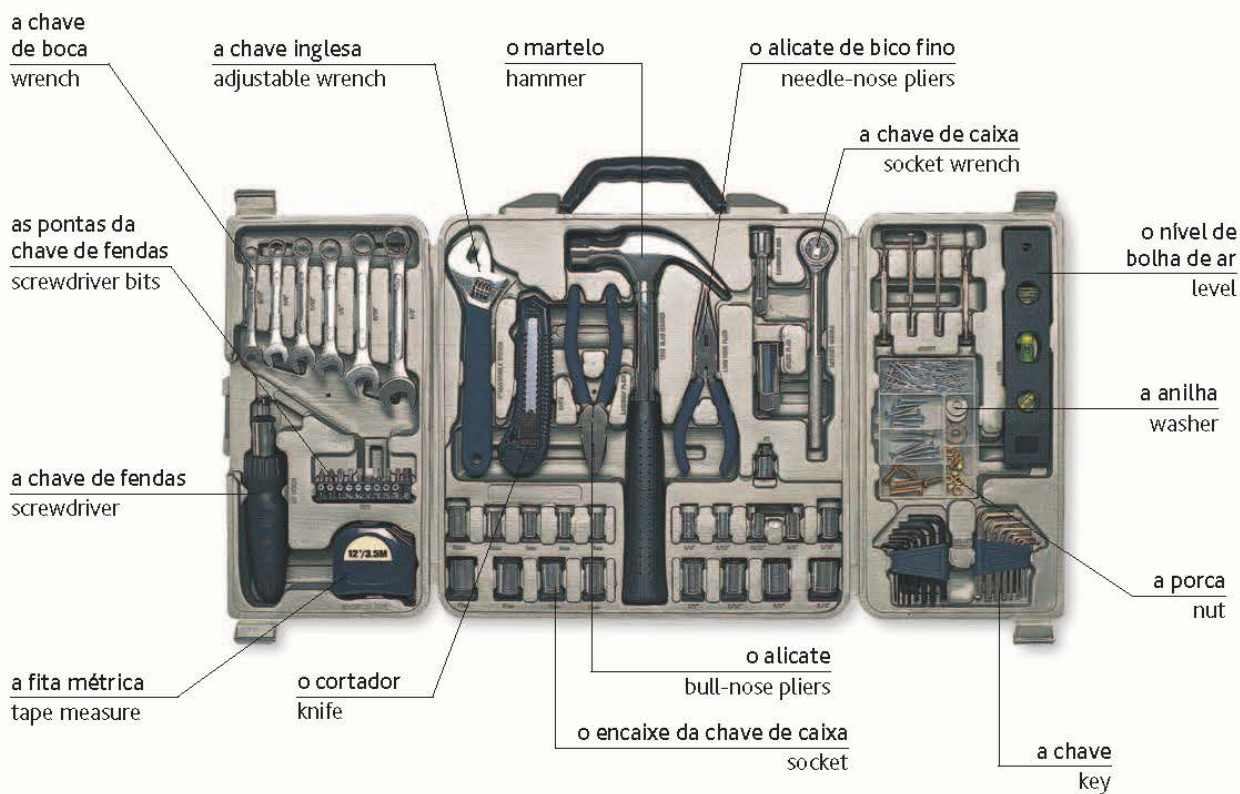

as brocas • drill bits

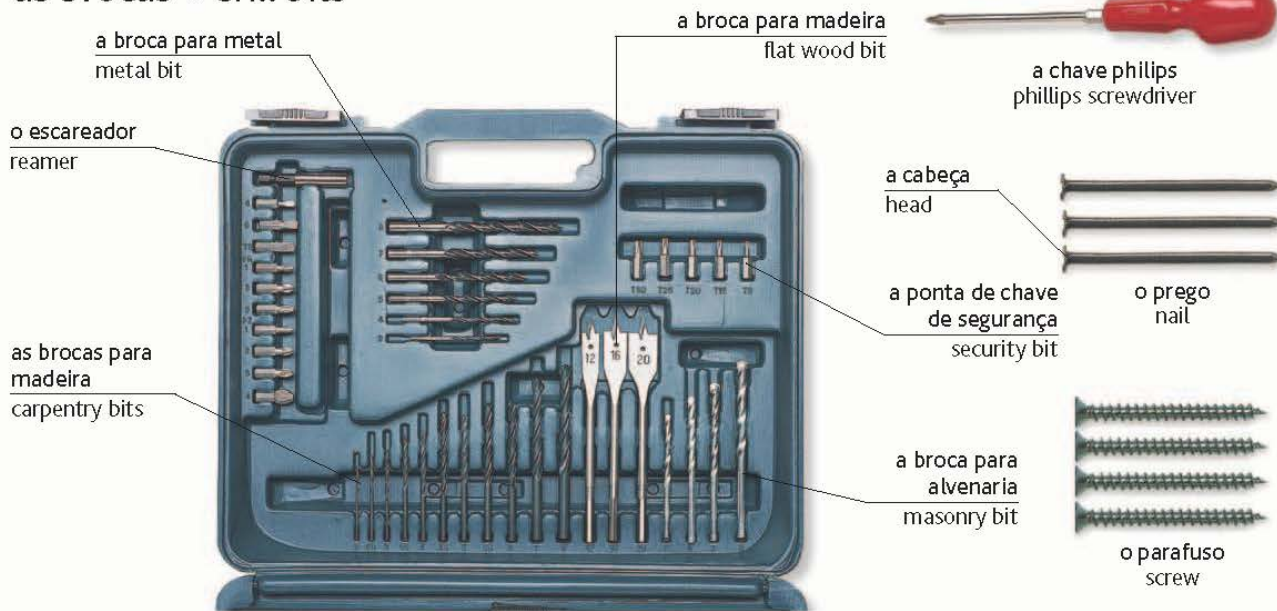



o descarnador de fios
wire strippers

o alicate corta-arames
wire cutters

o ferro de soldar
soldering iron

a fita isolante
electrical tape

a solda
solder

o escalpelo
scalpel



a serra de rodear
fretsaw



o serrote com costas | tenon saw



os óculos de
segurança
safety goggles



a plaina
plane



o serrote
handsaw

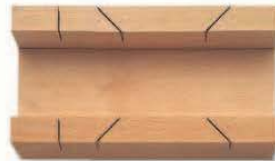

caixa de corte a 45º
miter block



a serra de metais
hacksaw



o berbequim manual
hand drill



a lâ de aço
steel wool



o papel de lixa
sandpaper

a chave inglesa
wrench



o formão
chisel



a lima
file



a pedra de amolar
sharpening stone



o corta-tubos | pipe cutter

o desentupidor
plunger



a decoração • decorating



a tesoura
scissors



o x-acto
utility knife



o fio de prumo
plumb line



o raspador
scraper

o pintor
decorator

o papel de parede
wallpaper

o escadote
stepladder



a trincha de alisar
o papel
wallpaper brush

a mesa de colar
pasting table

a trincha da cola
pasting brush

a cola de papel de
parede
wallpaper paste

o balde
pail

forrar com papel de parede (v) | wallpaper (v)



arrancar (v) | strip (v)



betumar (v) | fill (v)



lixar (v) | sand (v)



estucar (v) | plaster (v)



colocar o papel (v) | hang (v)



colocar azulejos (v) | tile (v)



vocabulário • vocabulary

o estuque
plaster

com brilho
gloss

o papel com relevo
embossed paper

a primeira demão
undercoat

o vedante
sealant

o verniz
varnish

mate
matte

o papel de base
lining paper

a última demão
top coat

o dissolvente
solvent

a tinta de água
latex

o stencil
stencil

o primário
primer

o conservante
preservative

a mistura para
juntas
grout

o jardim • garden

os estilos de jardim • garden styles

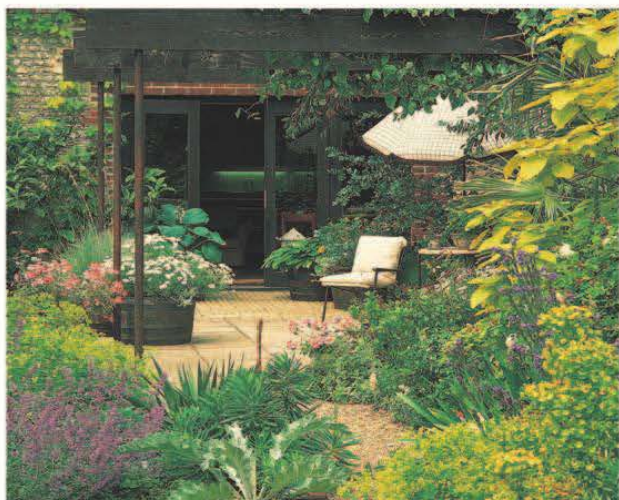

o pátio ajardinado | patio garden



o jardim de terraço
roof garden



o jardim de pedras
rock garden

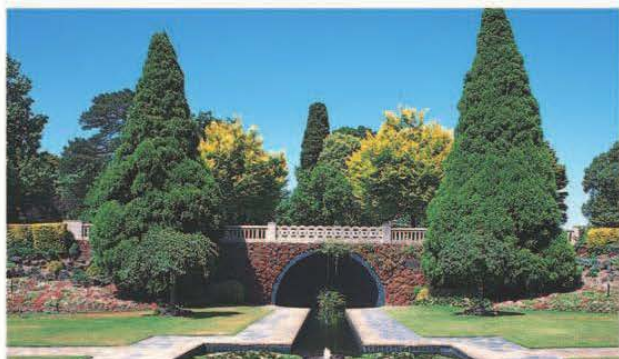

o jardim clássico | formal garden



o pátio | courtyard



o jardim campestre
cottage garden



o jardim de plantas herbáceas
herb garden



o jardim aquático
water garden

os adornos para o jardim • garden features

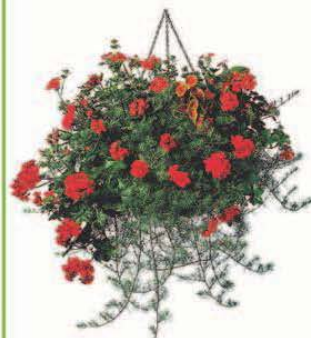

o cesto de pendurar
hanging basket



a treliça | trellis

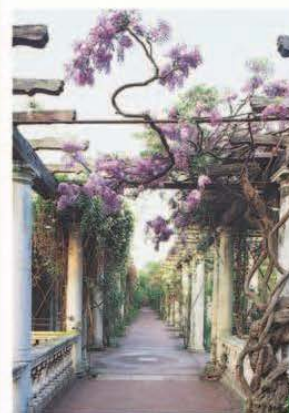

a pérgola
arbor

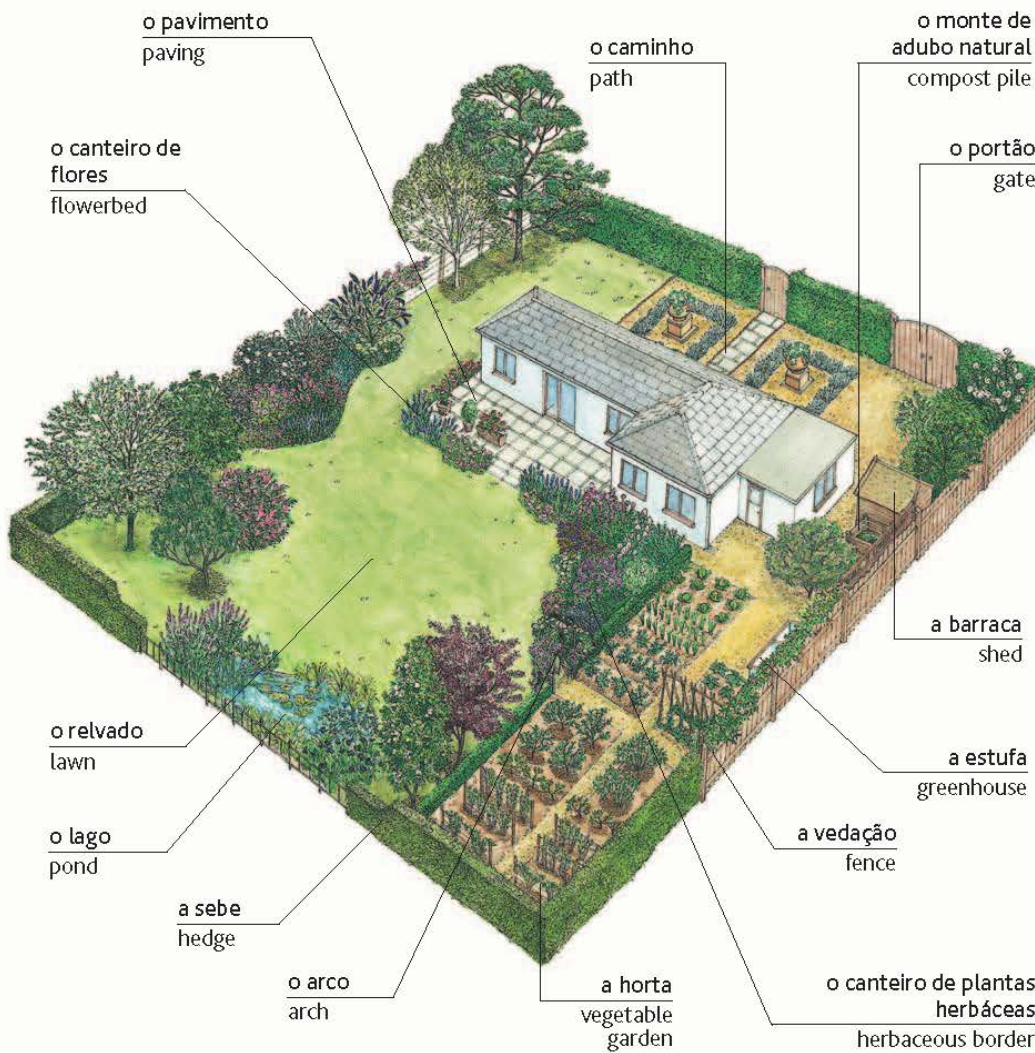

o solo • soil



a camada superior topsoil



a areia sand



a greda chalk



o silte silt



a argila clay



o deck de madeira deck

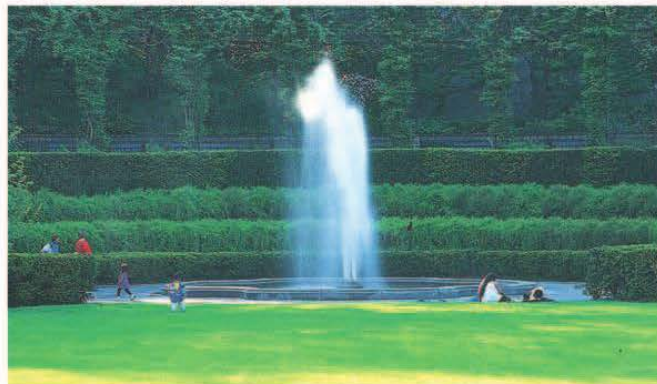

a fonte | fountain

as plantas de jardim • garden plants

os tipos de plantas • types of plants



anual
annual



bienal
biennial



vivaz
perennial

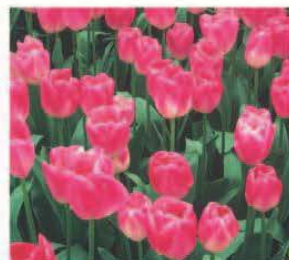

o bolbo
bulb



o feto
fern



o junco
rush



o bambu
bamboo



as ervas daninhas
weeds



a erva aromática
herb



a planta aquática
water plant



a árvore
tree



de folha caduca
deciduous



a palmeira
palm



a conífera
conifer



de folha persistente
evergreen



a topiária
topiary



a planta alpina
alpine



a planta suculenta
succulent



o cacto
cactus

a planta de vaso
potted plant

a planta de sombra
shade plant

a trepadeira
climber

o arbusto que dá
flores
flowering shrub

a vegetação de
cobertura
ground cover



a planta rasteira
creeper

ornamental
ornamental

a relva
grass

as ferramentas de jardim • garden tools



a pá
spade



a forquilha
pitchfork



a vassoura para relva
lawn rake

a podadeira de cabo comprido
long-handled shears



o ancinho
rake



o sachó
hoe



a terra adubada
compost



as sementes
seeds



a farinha de ossos
bone meal



a gravilha
gravel



o saco para a relva
grass bag

o motor
motor

o protector
shield

a roçadora
trimmer

a máquina de cortar relva
lawnmower



a cesta de jardineiro
tote



o suporte
stand

o carrinho de mão
wheelbarrow



o garfo para flores
hand fork



a tesoura de podar
pruners

as luvas de jardinagem
gardening gloves



a colher de transplante
trowel



o tabuleiro de
germinação
seed tray

a guita
twine

as etiquetas
labels

os atilhos de arame
twist ties

a lâmina
blade



a tesoura de jardim
shears



o pesticida
pesticide



as canas
canes



as anilhas
ring ties



a serra manual
hand saw



o crivo
sieve



o vaso
plant pot



as botas de borracha
rubber boots

a rega • watering

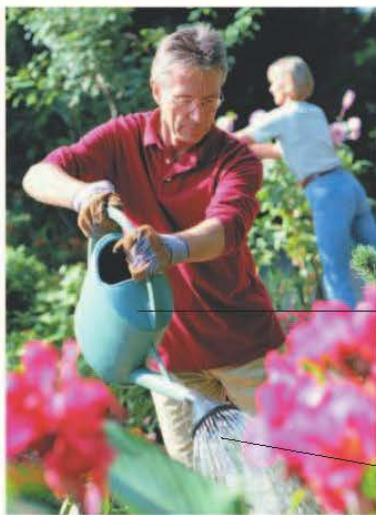

o pulverizador | spray bottle



o aspersor
sprinkler

a boquilha
nozzle

o regador
watering can

o ralo
rose

a mangueira
hose



o enrolador de mangueira | hose reel

a jardinagem • gardening



cortar a relva (v) | mow (v)



cobrir de relva (v)
sod (v)



arejar a relva (v)
spike (v)



raspar com a vassoura
de relva (v)
rake (v)



podar (v)
trim (v)



cavar (v)
dig (v)



semear (v)
sow (v)



adubar à superfície (v)
top-dress (v)



regar (v)
water (v)



guiar (v)
train (v)



tirar as flores mortas (v)
deadhead (v)

pulverizar (v)
spray (v)



a cana
cane



enxertar (v)
graft (v)



a estaca
cutting

propagar (v)
propagate (v)

podar (v)
prune (v)

estacar (v)
stake (v)



transplantar (v)
transplant (v)



mondar (v)
weed (v)



cobrir a terra (v)
mulch (v)

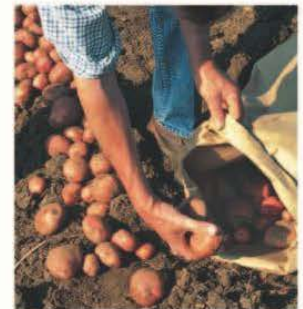

colher (v)
harvest (v)

vocabulário • vocabulary

cultivar (v)
cultivate (v)

desenhar (v)
landscape (v)

fertilizar (v)
fertilize (v)

peneirar (v)
sieve (v)

orgânico
organic

a plântula
seedling

o subsolo
subsoil

cuidar (v)
tend (v)

mudar de
vaso (v)
pot (v)

apanhar (v)
pick (v)

arejar (v)
aerate (v)

a drenagem
drainage

o adubo
fertilizer

o herbicida
weedkiller



os serviços
services

os serviços de emergência • emergency services

a ambulância • ambulance



a ambulância | ambulance



a maca
stretcher

o paramédico | paramedic

a polícia • police



o crachá
badge

o uniforme
uniform

a sirene
siren

as luzes
lights



o carro da polícia
police car



a estação da polícia
police station

o cassetete
nightstick

a pistola
gun



as algemas
handcuffs

o agente da polícia | police officer

vocabulário • vocabulary

o inspetor
lieutenant

o suspeito
suspect

a queixa
complaint

a prisão
arrest

o crime
crime

a agressão
assault

a investigação
investigation

a cela da
polícia
jail cell

o detective
detective

a impressão
digital
fingerprint

o assalto
burglary

a acusação
charge

os bombeiros • fire department



o incêndio | fire

o fumo
smoke

a
mangueira
hose

a cesta
basket

a lança
boom

o capacete
helmet

o jacto de água
water jet



os bombeiros
firefighters

a escada
ladder

a cabina
cab



o quartel dos bombeiros
fire station



a saída de emergência
fire escape



o camião dos bombeiros
fire engine



o detector de fumo
smoke alarm



o alarme de incêndio
fire alarm



o machado
ax



o extintor de incêndio
fire extinguisher



a boca-de-incêndio
hydrant

Preciso da polícia / dos bombeiros /
de uma ambulância.
I need the police/fire department/
ambulance.

Há um incêndio em...
There's a fire at...

Houve um acidente.
There's been an accident.

Chame a polícia!
Call the police!

o banco • bank

o cliente
customer

o guiché
window

o caixa
teller



os folhetos
leaflets

o balcão
counter

o talão de depósito
deposit slips

o cartão de débito
debit card

o talão do cheque
stub

o número da conta
account number

a assinatura
signature

a quantia
amount



o gerente do banco
bank manager



o cartão de crédito
credit card



o livro de cheques
checkbook

o cheque
check

vocabulário • vocabulary

as poupanças
savings

a hipoteca
mortgage

o pagamento
payment

depositar (v)
deposit (v)

a conta corrente
checking account

o imposto
tax

o descoberto
line of credit

o débito directo
automatic payment

o encargo bancário
fee

a conta de poupança
savings account

o empréstimo
loan

a taxa de juro
interest rate

o talão de levantamento
withdrawal slip

a transferência bancária
electronic transfer

o número do código secreto
PIN

a moeda
coin



a nota
bill

o dinheiro | money

o ecrã
screen

o teclado
keypad



a ranhura do
cartão
card slot

o caixa automático | ATM

as divisas • foreign currency



o serviço de câmbio
currency exchange bureau



o cheque de viagem
traveler's check



a taxa de câmbio
exchange rate

vocabulário • vocabulary

levantar (v)
cash (v)

as acções
shares

a divisa
denomination

os dividendos
dividends

a comissão
commission

o contabilista
accountant

o investimento
investment

a carteira
portfolio

os títulos
stocks

os capitais próprios
equity

as finanças • finance

a cotação das acções
share price

o corretor da bolsa
stockbroker



a assessora financeira
financial advisor



a bolsa de valores | stock exchange

Posso cambiar isto, por favor?
Can I change this please?

Qual é a taxa de câmbio de hoje?
What's today's exchange rate?

as comunicações • communications

o empregado
dos correios
postal worker

o guiché
window

a balança
scales

o balcão
counter



os correios | post office

o carimbo postal
postmark

o selo
stamp

a morada
address

o código postal
ZIP code



o envelope | envelope



o carteiro
mail carrier

vocabulário • vocabulary

a carta
letter

a morada do
remetente
return address

a entrega
delivery

frágil
fragile

não dobrar (v)
do not bend (v)

por avião
by airmail

a assinatura
signature

o vale postal
money order

o saco do correio
mailbag

para cima
this way up

correio registado
registered mail

a recolha
pickup

a franquia
postage

o telegrama
telegram

o fax
fax



o marco de correio
mailbox



a caixa de correio
letter slot



a encomenda
package



o mensageiro
delivery service

o telefone • telephone

o auscultador
handset

a base
base station



o telefone sem fios
cordless phone

o gravador de
chamadas
answering machine



o videotelefone
video phone



a cabina telefónica
phone booth



o telemóvel
cell phone

o teclado
keypad

o auricular
receiver

as moedas devolvidas
coin return



o telefone de moedas
coin phone



o telefone de cartão
card phone

vocabulário • vocabulary

o serviço de informações
directory assistance

atender (v)
answer (v)

o telefonista
operator

Poderia dar-me o número de...?
Can you give me the number for...?

a chamada paga no
destino
collect call

a mensagem de texto
text message

ocupado
busy

Qual é o indicativo para...?
What is the area code for...?

marcar (v)
dial (v)

a mensagem de voz
voice message

desligado
disconnected

o hotel • hotel

o lóbi • lobby



a recepção | reception



a bagagem
luggage

o carrinho
cart

o porteiro | porter



o elevador | elevator



o número do quarto
room number

os quartos • rooms



o quarto individual
single room



o quarto duplo
double room



o quarto com duas camas
twin room



a casa de banho privativa
private bathroom

os serviços • services

o serviço de limpeza
maid serviceo serviço de lavanderia
laundry servicea bandeja do pequeno-almoço
breakfast tray

o serviço de quarto | room service

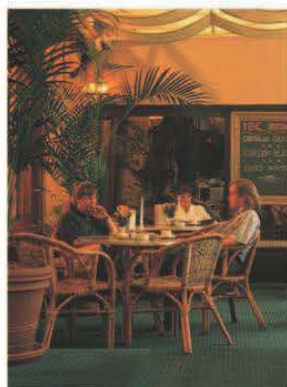
o minibar
minibaro restaurante
restauranto ginásio
gyma piscina
swimming pool

vocabulário • vocabulary

o quarto com pequeno-almoço
bed and breakfasta pensão completa
all meals includeda meia pensão
some meals includedTem quartos livres?
Do you have any vacancies?Tenho uma reserva.
I have a reservation.Queria um quarto individual.
I'd like a single room.Queria um quarto para três noites.
I'd like a room for three nights.Quanto é a diária?
What is the charge per night?A que horas tenho que sair do quarto?
When do I have to check out?

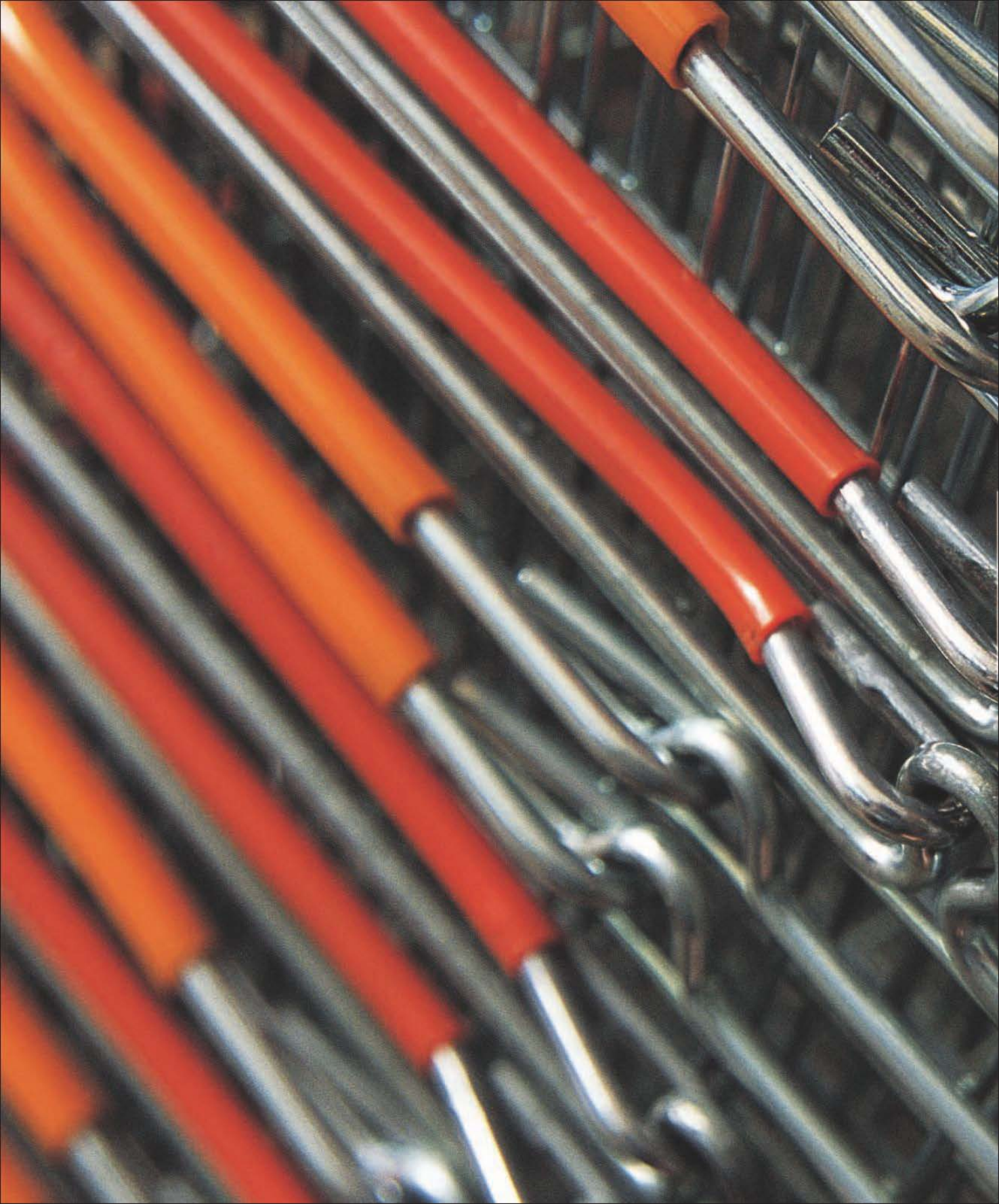



as compras
shopping

o centro comercial • shopping center

o átrio
atrium

o sinal
sign

o elevador
elevator



o segundo andar
third floor

o primeiro andar
second floor

as escadas rolantes
escalator

o rés-do-chão
ground floor

o cliente
customer

vocabulário • vocabulary

a secção de criança
children's department

a secção de bagagens
luggage department

a secção de sapataria
shoe department

a planta do centro
store directory

o empregado
sales clerk

os serviços de
atendimento ao
cliente
customer services

as cabinas de prova
changing rooms

o fraldário
baby changing facilities

as casas de banho
restrooms

Quanto custa isto?
How much is this?

Posso trocar isto?
May I exchange this?

os grandes armazéns • department store



a roupa de homem
men's wear



a roupa de senhora
women's wear



a lingerie
lingerie



a perfumaria
perfume



os produtos de beleza
beauty



os têxteis para o lar
bed and bath



as mobílias e a decoração
home furnishings



a retrosaria
notions



o equipamento de cozinha
kitchenware



a loiça
china



os aparelhos eléctricos
electronics



a iluminação
lighting



os artigos desportivos
sports



os brinquedos
toys



os artigos de escritório
stationery



o supermercado
groceries

o supermercado • supermarket



o corredor
aisle

a prateleira
shelf

a correia transportadora
conveyor belt

o caixa
checker

as ofertas
offers

a caixa | checkout

o cliente
customer

a caixa
registadora
cash register

o saco de
compras
shopping bag



o carrinho | cart

as mercearias
groceries

a pega
handle



o cesto | basket



o código de barras
bar code



o scanner | scanner



a padaria
bakery



os laticínios
dairy



os cereais
cereals



as conservas
tinned food



a confeitaria
confectionery



os legumes
vegetables



a fruta
fruit



a carne e as aves
meat and poultry



o peixe
fish

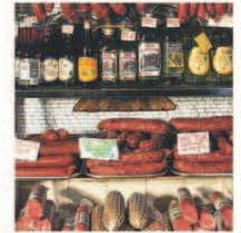

a charcutaria
deli



os congelados
frozen food



a comida pronta
convenience food



as bebidas
drinks



os produtos de limpeza
household products



os artigos de
higiene pessoal
toiletries



os artigos para bebé
baby products



os electrodomésticos
electrical goods



a comida para animais
pet food



as revistas | magazines

a farmácia • drugstore

os cuidados dentários
dental care

a higiene feminina
feminine hygiene

os desodorizantes
deodorants

as vitaminas
vitamins

o dispensário
pharmacy



o farmacêutico
pharmacist

o xarope para a tosse
cough medicine

os medicamentos
fitoterápicos
herbal remedies

os cuidados da pele
skin care



o creme pós-solar
aftersun

o protector solar
sunscreen



o creme protector total
sunblock



o repelente de insectos
insect repellent



a toalhita húmida
wet wipe



o lenço de papel
tissue



o penso higiênico
sanitary towel



o tampão
tampon



o protege-slip
panty liner



a cápsula
capsule



o comprimido
pill

a colher doseadora
measuring spoon



o xarope
syrup

as instruções
instructions



o inalador
inhaler



o creme
cream



a pomada
ointment



o gel
gel



o supositório
suppository



as gotas
drops

o conta-gotas
dropper



a seringa
syringe

a agulha
needle



o spray
spray



o pó
powder

vocabulário • vocabulary

o ferro
iron

a insulina
insulin

descartável
disposable

o medicamento
medicine

o analgésico
painkiller

o cálcio
calcium

os efeitos secundários
side effects

solúvel
soluble

o laxativo
laxative

o sedativo
sedative

o magnésio
magnesium

o prazo de validade
expiration date

a dose
dosage

a diarreia
diarrhea

o comprimido para
dormir
sleeping pill

as multivitaminas
multivitamins

os comprimidos para o
enjoo
travel sickness pills

a medicação
medication

a pastilha para a
garganta
throat lozenge

o anti-inflamatório
anti-inflammatory

a florista • florist

as flores
flowers

o lírio
lily

a acácia
acacia

o cravo
carnation

a planta de vaso
potted plant

o gladiolo
gladiolus

a íris
iris

a margarida
daisy

o crisântemo
chrysanthemum

a gipsófila
gypsophila

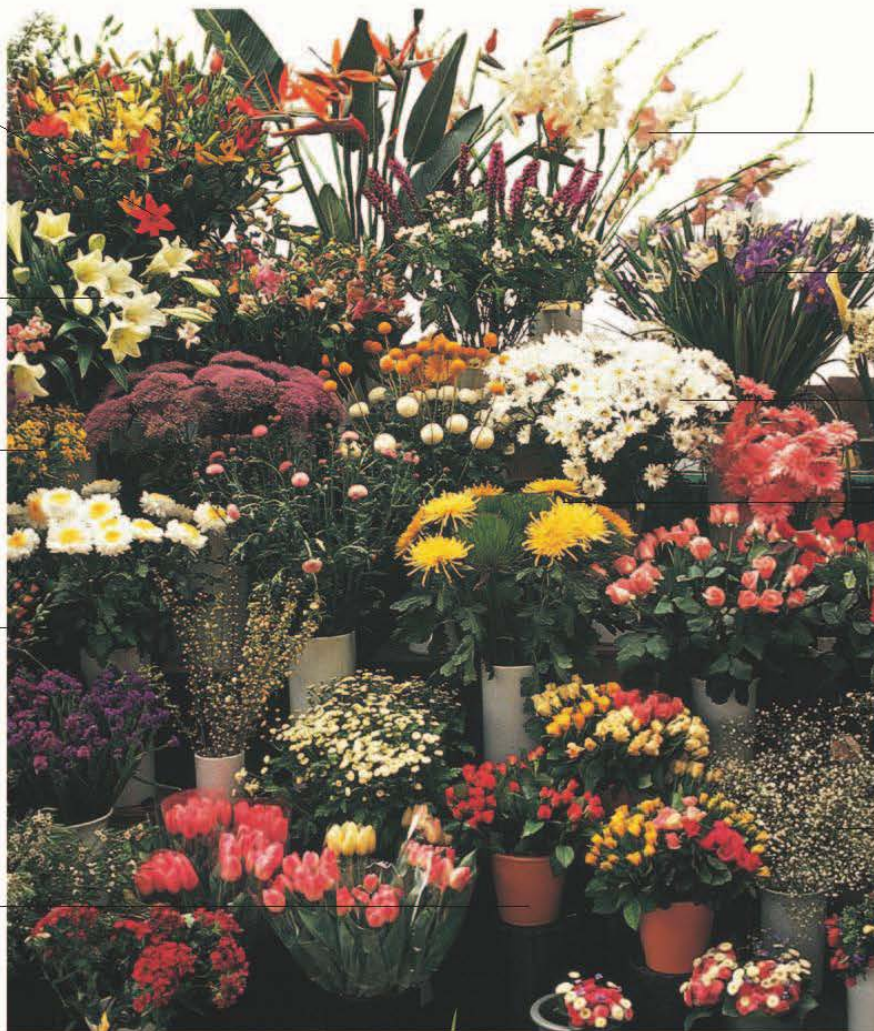

o goivo
stocks



a gerbera
gerbera



a folhagem
foliage



a rosa
rose



a frésia
freesia

os arranjos • arrangements



a jarra
vase

a orquídea
orchid

a peónia
peony

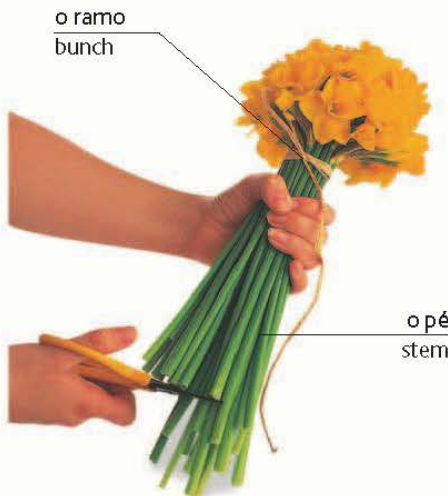

o ramo
bunch

o pé
stem

o narciso
daffodil

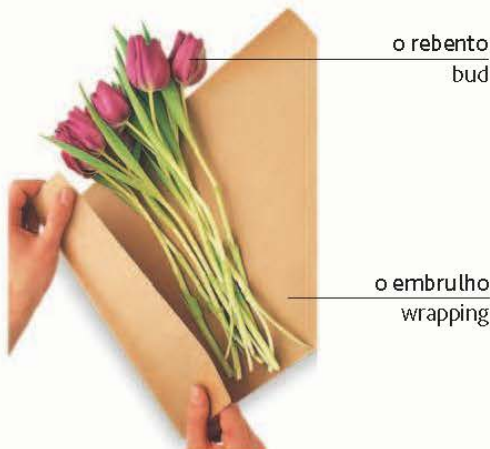

o rebento
bud

o embrulho
wrapping

a tília | tulip



a fita
ribbon

o buquê
bouquet



as flores secas
dried flowers



o pot-pourri | potpourri



a coroa | wreath



a grinalda
garland

Posso juntar uma mensagem?
Can I attach a message?

São perfumadas?
Are they fragrant?

Podia embrulhar-mas?
Can I have them wrapped?

Quanto tempo durarão estas?
How long will these last?

Pode enviá-las para...?
Can you send them to...?

Podia dar-me um ramo de..., por favor?
Can I have a bunch of... please.

o vendedor de jornais • newsstand



os cigarros
cigarettes

o maço de cigarros
pack of cigarettes

os fósforos
matches

os bilhetes da lotaria
lottery tickets

os selos
stamps



o bilhete postal
postcard

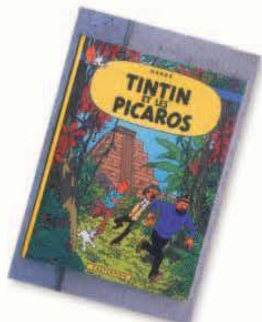

a revista de banda
desenhada
comic book



a revista
magazine



o jornal
newspaper

fumar • smoking



o tabaco
tobacco



o isqueiro
lighter



a haste
stem

o forninho
bowl

o cachimbo
pipe



o charuto
cigar

o vendedor de doces • confectionery

a caixa de chocolates
box of chocolates

a barrita
de snack
snack bar

as batatas fritas
de pacote
chips



a loja de doces | candy store

vocabulário • vocabulary

o chocolate de leite
milk chocolate

o caramelo
caramel

o chocolate preto
dark chocolate

a trufa
truffle

o chocolate branco
white chocolate

a bolacha
cookie

os doces a granel
pick and mix

os rebuçados
hard candy

os doces • confectionery



o chocolate
chocolate



a tablete de chocolate
chocolate bar



os rebuçados
candies



o chupa-chupa
lollipop



o caramelo | toffee



o torrão | nougat



a goma marshmallow
marshmallow



o rebuçado de menta
mint



a pastilha elástica
chewing gum



as gomas em forma de
feijão
jellybean



as gomas de fruta
jelly candy



o alcaçuz
licorice

as outras lojas • other stores



a padaria
bakery



a confeitaria
pastry shop



o talho
butcher shop



a peixaria
fishmonger



a loja de frutas e legumes
greengrocer



a mercearia
grocery store



a sapataria
shoe store



a loja de ferragens
hardware store



a loja de antiguidades
antique shop



a loja de artigos de oferta
gift shop



a agência de viagens
travel agent



a joalheria
jeweler



a livraria
bookstore



a loja de discos
record store



a loja de bebidas alcoólicas
liquor store



a loja de animais de
estimação
pet store



a loja de mobílias
furniture store



a boutique
boutique

vocabulário • vocabulary

o agente imobiliário
real estate agent

a loja de artigos fotográficos
camera store

o centro de jardinagem
garden center

a loja de produtos naturais
health food store

a tinturaria
dry cleaner

a loja de materiais de arte
art supply store

a lavandaria automática
laundromat

a loja de artigos usados
secondhand store



o alfaiate
tailor

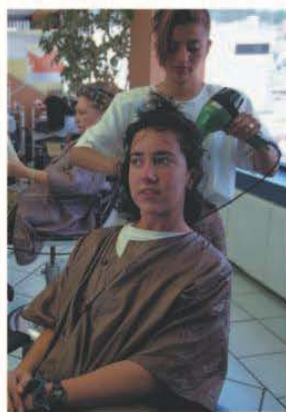

o cabeleireiro
hairdresser's



o mercado | market





os alimentos
food

a carne • meat



a carne de borrego
lamb

o talhante
butcher

hak rzeźnicki
meat hook

a balança
scales

o afiador de facas
knife sharpener

o bacon
bacon

as salsichas
sausages

o fígado
liver

vocabulário • vocabulary

a carne de porco
pork

a carne de veado
venison

os miúdos
variety meat

criado ao ar livre
free range

a carne vermelha
red meat

a carne de vaca
beef

o coelho
rabbit

curado
cured

biológico
organic

a carne magra
white meat

a carne de vitela
veal

a língua
tongue

fumado
smoked

a carne branca
white meat

as carnes frias
cooked meat

os cortes de carne • cuts

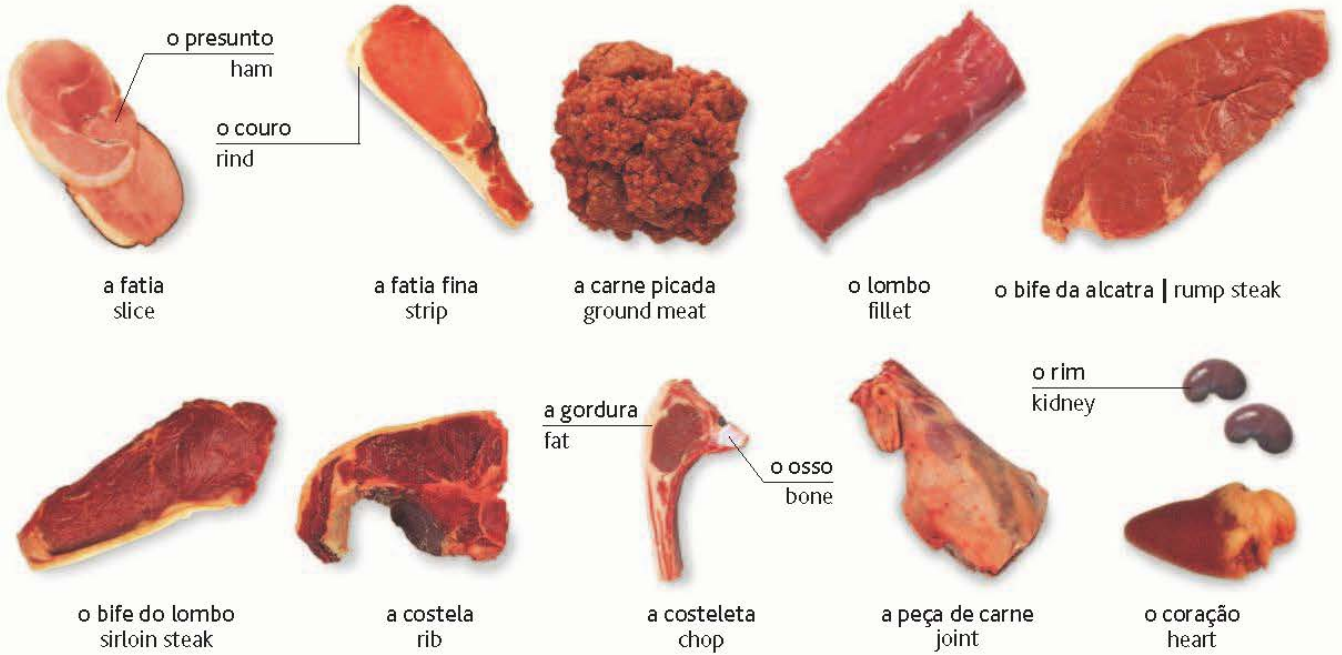

a carne de aves • poultry

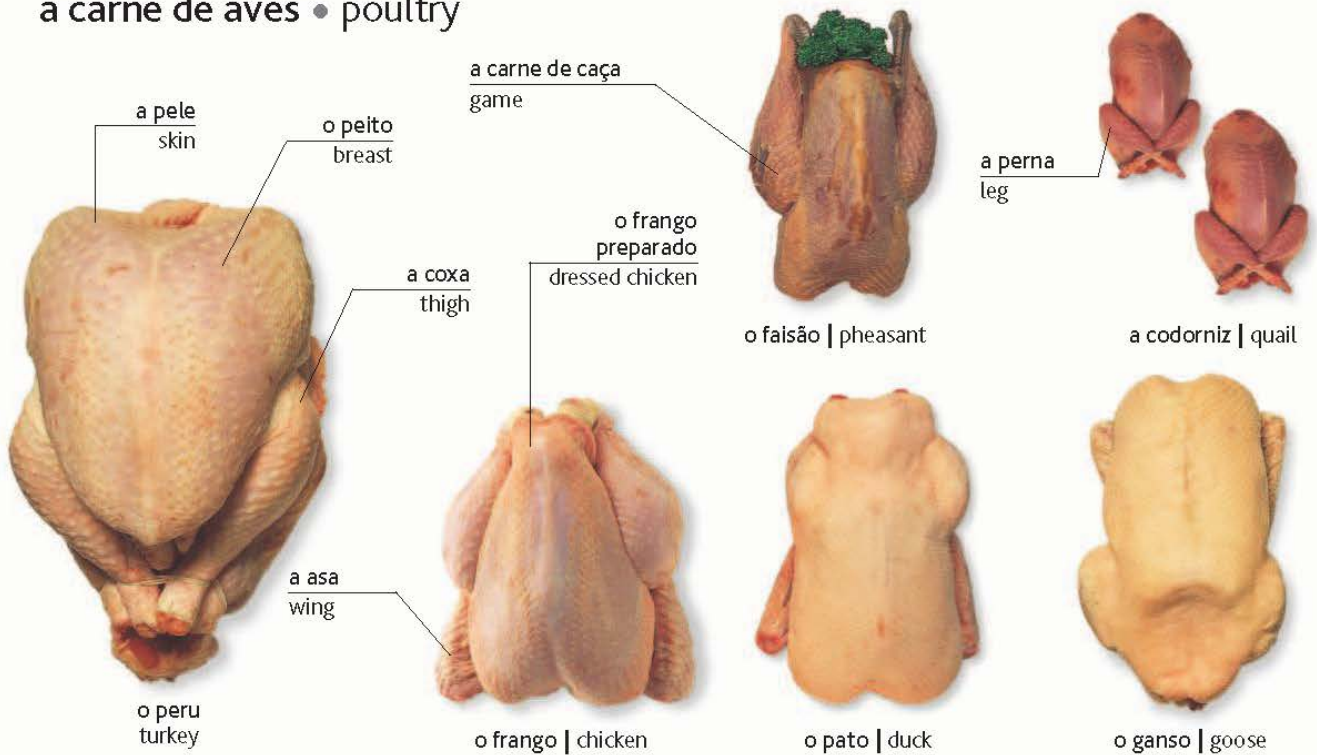

o peixe • fish

as gambas peladas
peeled shrimp

o gelo
ice

o salmonete
red mullet

os filetes de alabote
halibut filets

a truta arco-íris
rainbow trout

as abas de rala
skate wings

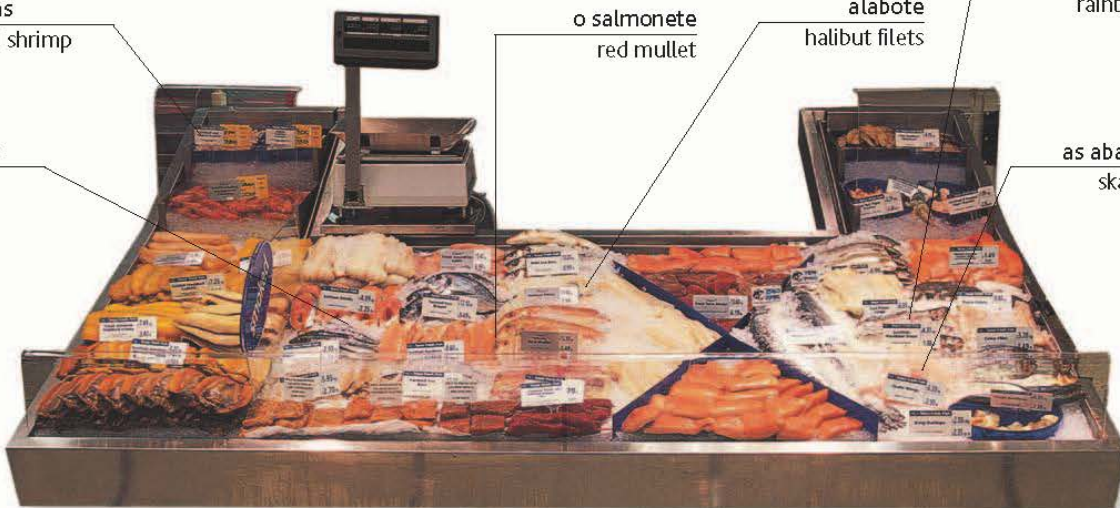

a peixaria
fish counter



o tamboril
monkfish



a cavala
mackerel



a truta
trout



o peixe-espada
swordfish



o linguado
Dover sole



a solha-limão
lemon sole



a arinca
haddock



a sardinha
sardine



a raia
skate



o badejo
whiting



o robalo
sea bass



o salmão | salmon



o bacalhau
cod



o pargo
sea bream



o atum
tuna

os mariscos • seafood

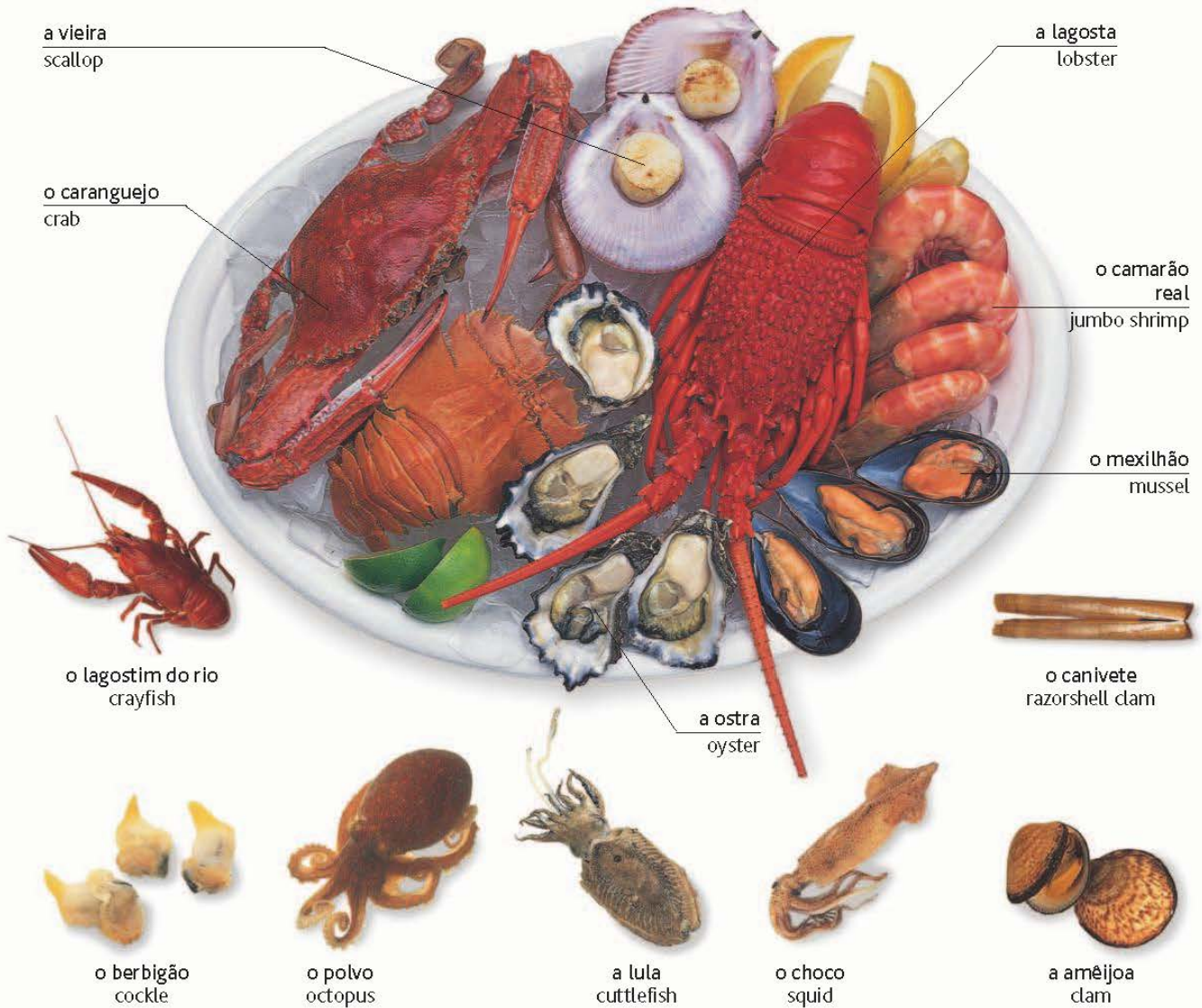

vocabulário • vocabulary

congelado frozen	limpo cleaned	fumado smoked	escamado descaled	filete filet	o lombo loin	a cauda tail	a espinha bone	a escama scale
fresco fresh	salgado salted	sem pele skinned	sem espinhas boned	em filetes fileted	a posta steak	Pode limpar-mo? Will you clean it for me?		

os legumes 1 • vegetables 1

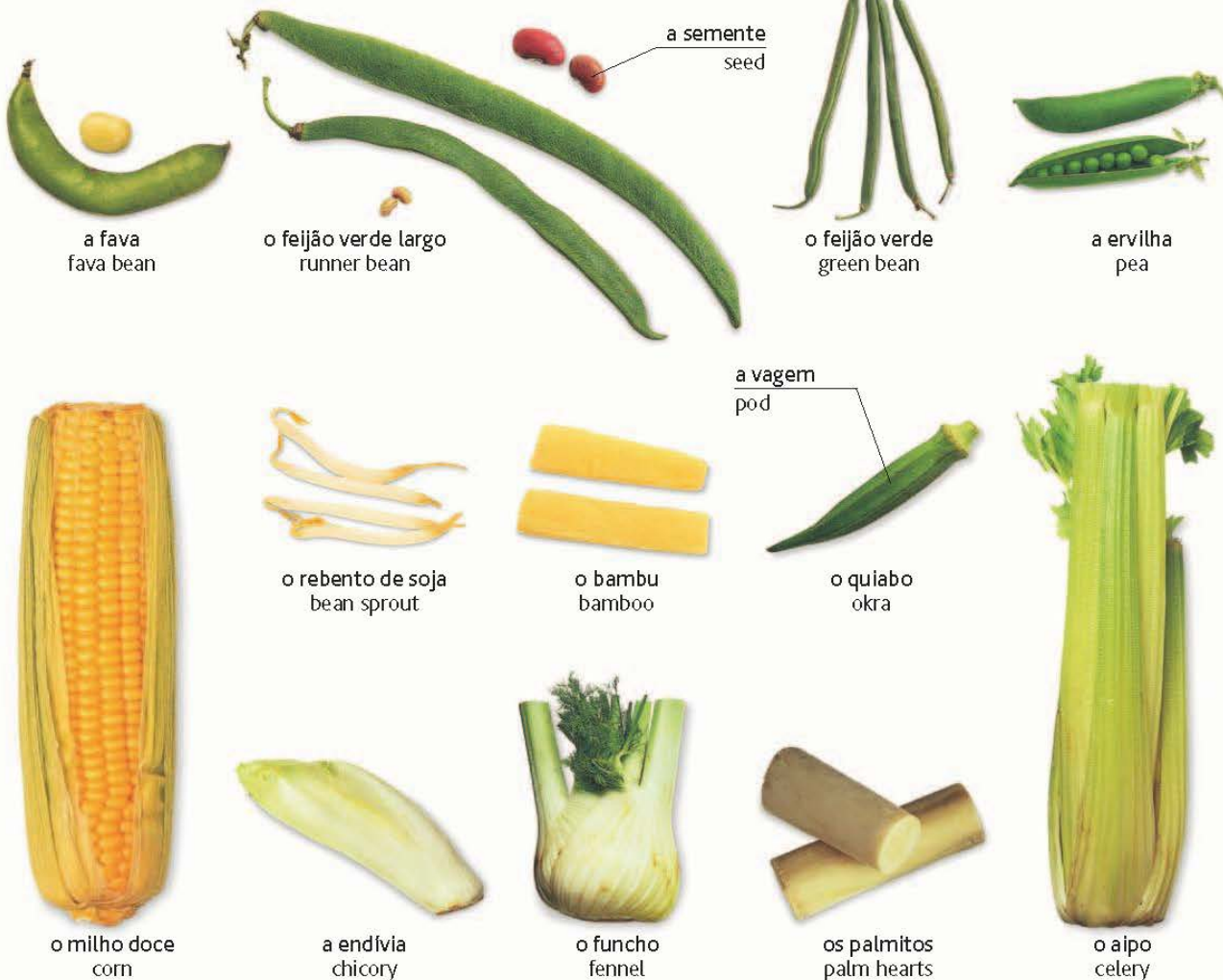

vocabulário • vocabulary

a folha
leaf

a flor
flore

a ponta
tip

biológico
organic

Vende legumes biológicos?
Do you sell organic vegetables?

o caule
stalk

a amêndoa
kernel

o centro
heart

o saco plástico
plastic bag

São produtos locais?
Are these grown locally?



a rúcula
arugula



o agrião
watercress



a couve roxa
radicchio



a couve-de-bruxelas
brussels sprout



a acelga
swiss chard



a couve frisada
kale



a azeda
sorrel



a endívia
endive



o dente-de-leão
dandelion



o espinafre
spinach



a couve-rábano
kohlrabi



a couve chinesa
bok choy



a alface
lettuce



os brócolos
broccoli



a couve
cabbage



a couve penca
greens

os legumes 2 • vegetables 2

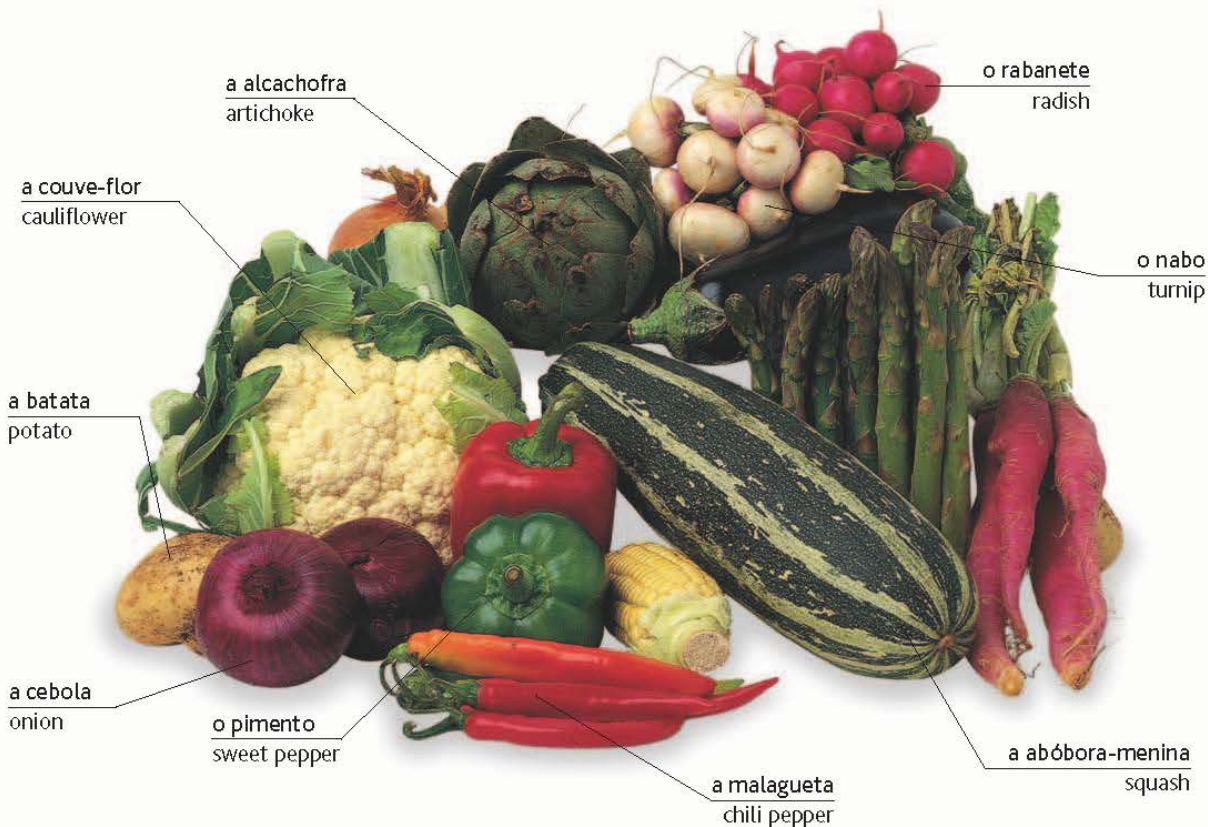

vocabulário • vocabulary

o tomate cereja
cherry tomato

o aipo-rábano
celery

congelado
frozen

amargo
bitter

Pode dar-me um quilo de batatas, por favor?
Can I have one kilo of potatoes please?

a cenoura
carrot

a raiz de taro
taro root

cru
raw

firme
firm

Quanto é o quilo?
What's the price per kilo?

a fruta-pão
breadfruit

a mandioca
cassava

picante
hot (spicy)

a polpa
flesh

Como se chamam esses?
What are those called?

a batata nova
new potato

a castanha-de-
água
water chestnut

doce
sweet

a raiz
root



a batata doce
sweet potato



o inhame
yam



a beterraba
beet



a couve-nabo
rutabaga



a alcachofra
Jerusalem artichoke



o rábano picante
horseradish



a pastinaga
parsnip



o gengibre
ginger



a beringela
eggplant



o tomate
tomato



o cebolinho
green onion

o alho francês
leek



a chalota
shallot



o alho
garlic

o dente
clove



o cogumelo
mushroom

a trufa
truffle

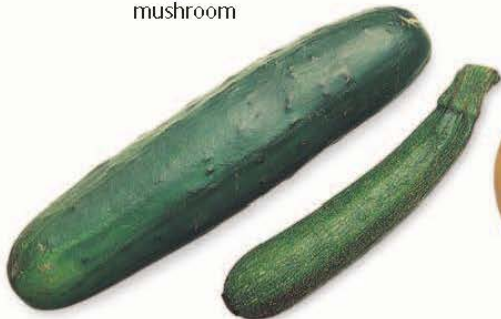

o pepino
cucumber

a curgete
zucchini



a cabaça
butternut squash



a abóbora-porqueira
acorn squash



a abóbora
pumpkin

a fruta 1 • fruit 1

os citrinos • citrus fruit



a laranja
orange



a clementina
clementine



o ugli
ugli fruit

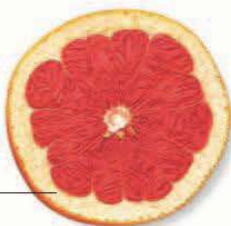

a pele
pith

a toranja
grapefruit



a tangerina
tangerine

o gomo
segment

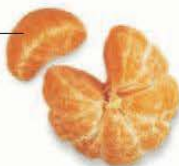

a satsuma
satsuma



a lima
lime

a casca
zest



o limão
lemon



o kumquat
kumquat

a fruta com caroço • stoned fruit



o pêssego
peach



a nectarina
nectarine



o alperce
apricot



a ameixa
plum



a cereja
cherry

a pêra
pear

a maçã
apple



o cesto de fruta | basket of fruit

as bagas e os melões • berries and melons

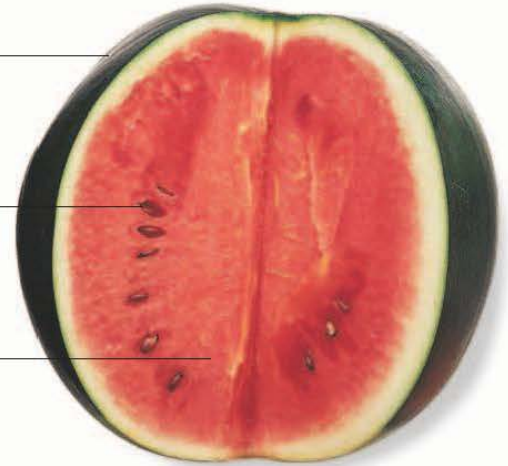
o morango
strawberrya framboesa
raspberryo melão
melona uva
grapesa amora
blackberrya groselha vermelha
red curranta groselha negra
black curranta uva-dos-montes
cranberryo mirtilo
blueberrya groselha branca
white curranta framboesa silvestre
loganberrya groselha-espim
gooseberrya casca
rinda semente
seedsa polpa
flesha melancia
melon

vocabulário • vocabulary

o ruibarbo
rhubarbácido
sourviçoso
crispo sumo
juiceEstão maduros?
Are they ripe?a fibra
fiberfresco
freshpodre
rotteno coração
corePosso provar um?
Can I try one?doce
sweetsumarento
juicya polpa
pulpsem grainhas
seedlessQuanto tempo durarão?
How long will they keep?

a fruta 2 • fruit 2

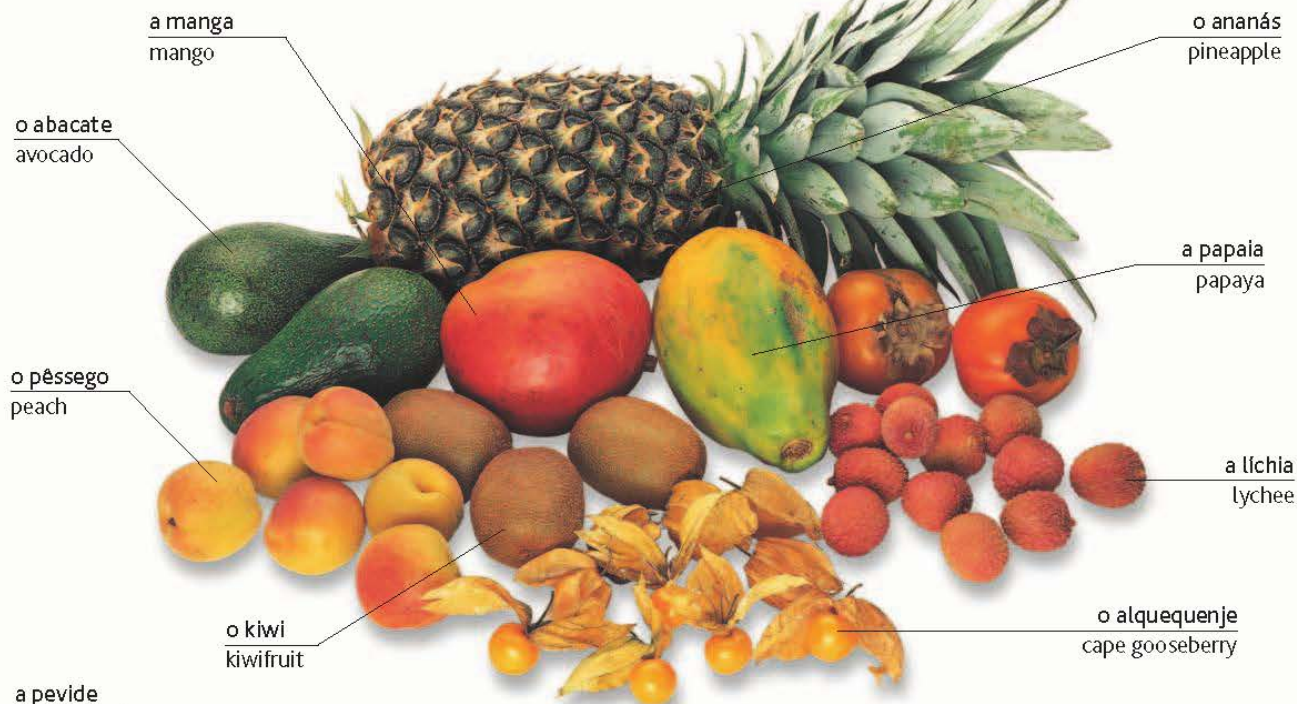

a pevide
seed



o marmelo
quince



o maracujá
passion fruit



a casca
peel

a banana
banana



a goiaba
guava

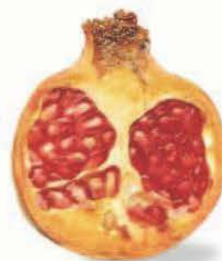

a romã
pomegranate



o dióspiro
persimmon



a feijoa
feijoa



o figo da Índia
prickly pear



a carambola
starfruit



o mangustão
mangosteen

os frutos secos • nuts and dried fruit

o pinhão
pine nuto pistácio
pistachioo caju
cashewo amendoim
peanuta avelã
hazelnuta castanha-do-pará
brazil nuta noz pecan
pecana amêndoa
almonda noz
walnuta castanha
chestnuta macadâmnia
macadamiao figo
figa tâmara
datea ameixa seca
prunea sultana
seedless raisina passa
raisina passa de Corinto
curranta casca
shella polpa
flesho coco
coconut

vocabulário • vocabulary

verde
greenduro
harda amêndoa
kernelsalgado
saltedtorrado
roastedpelado
shelleda fruta cristalizada
candied fruitmaduro
ripemole
softdesidratado
desiccatedcru
rawda estação
seasonalinteiro
wholea fruta tropical
tropical fruit

os grãos e as leguminosas • grains and pulses

os grãos • grains



o trigo
wheat



a aveia
oats



a cevada
barley

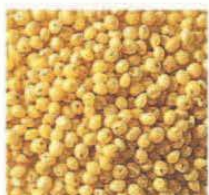

o milho-miúdo
millet



o milho
com

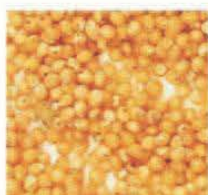

a quinoa
quinoa

vocabulário • vocabulary

a semente seed	perfumado fragranced	de fácil cozedura quick-cooking
a casca husk	o cereal cereal	de grãos longos long-grain
o grão kernel	integral whole-grain	de grãos curtos short-grain
seco dry	pôr de molho (v) soak (v)	
fresco fresh		

o arroz • rice



o arroz branco
white rice



o arroz integral
brown rice



o arroz selvagem
wild rice



o arroz para doce
arborio rice

os grãos processados • processed grains



o cuscuz
couscous



o trigo partido
cracked wheat



a sémola
semolina



o farelo
bran

os feijões e as ervilhas • beans and peas



o feijão manteiga
butter beans



o feijão branco miúdo
navy beans



o feijão encarnado
red kidney beans



o feijão aduki
adzuki beans



as favas
fava beans



o grão de soja
soybeans



o feijão frade
black-eyed beans



o feijão pinto
pintos beans



o feijão mung
mung beans



o feijão branco
flageolet beans



a lentilha castanha
brown lentils



a lentilha vermelha
red lentils



as ervilhas
green peas



os grãos de bico
chick peas



as ervilhas secas
split peas

as sementes • seeds



a semente de
abóbora
pumpkin seed



a semente de
mostarda
mustard seed



a alcaravia
caraway



a semente de sésamo
sesame seed

a semente de girassol
sunflower seed



as ervas aromáticas e as especiarias • herbs and spices

as especiarias • spices



a baunilha | vanilla



a noz mozcada
nutmeg



o macis
mace



a curcuma
turmeric



os cominhos
cumin



o ramo aromático
bouquet garni



a pimenta da Jamaica
allspice



a pimenta em grão
peppercorn



o fenacho
fenugreek



o piri-piri
chili pepper

inteiro
whole

esmagado
crushed



o açafraão
saffron



o cardamomo
cardamom



o pó de caril
curry powder

moldo
ground



o colorau
paprika

laminado
flakes



o alho
garlic



as ervas aromáticas • herbs

os paus de
canela
sticks



a canela
cinnamon



a citronela
lemon grass



os cravinhos
cloves



o anis estrelado
star anise



o gengibre
ginger

as sementes de
funcho
fennel seeds



o funcho
fennel



a cebolinha
chives



a hortelã
mint



o estragão
tarragon



a manjerona
marjoram



os orégãos
oregano



o coentro
coriander



a folha de louro
bay leaf



a salsa
parsley



o tomilho
thyme



a salva
sage



o basílico
basil



o endro
dill



o rosmaninho
rosemary

os alimentos engarrafados • bottled foods



os doces para barrar • sweet spreads



os condimentos e as pastas de barrar • condiments and spreads



o boião hermético
sealed jar



a manteiga de
amendoim
peanut butter



o chocolate de barrar
chocolate spread



a fruta em conserva
preserved fruit

vocabulário • vocabulary

o óleo de milho
corn oil

o óleo de colza
canola oil

o óleo de
amendoim
groundnut oil

o óleo extraído a
frio
cold-pressed oil

o óleo vegetal
vegetable oil

os lacticínios • dairy produce

o queijo • cheese

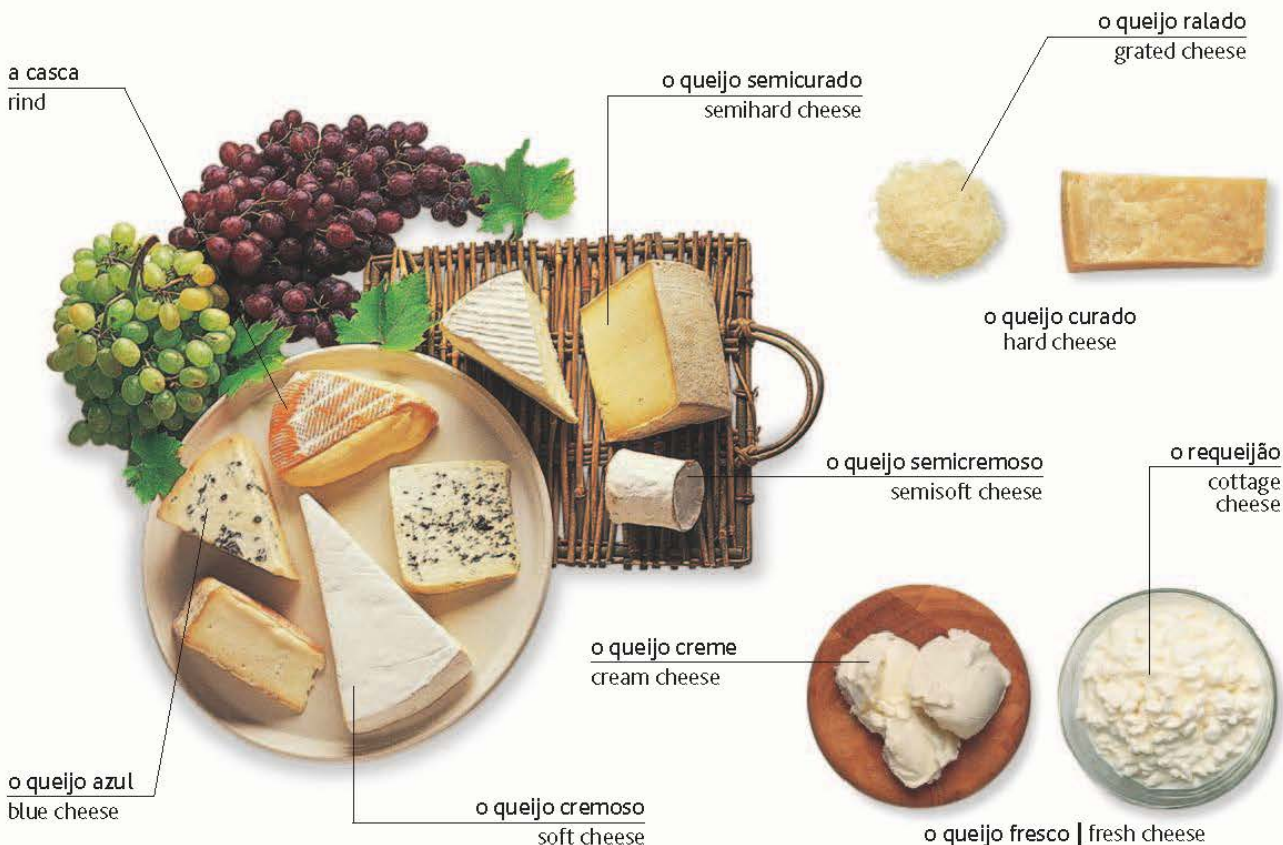

o leite • milk





a manteiga
butter



a margarina
margarine



a nata
cream



a nata líquida
light cream



a nata gorda
heavy cream



a nata batida
whipped cream



a nata azeda
sour cream



o iogurte
yogurt



o gelado
ice cream

os ovos • eggs

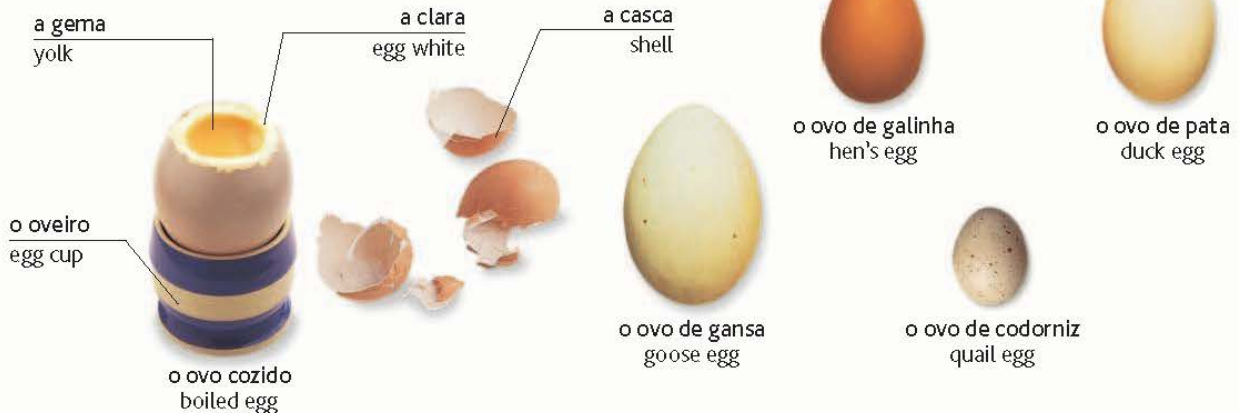

vocabulário • vocabulary

pasteurizado
pasteurized

o batido de leite
milkshake

com sal
salted

o leite de ovelha
sheep's milk

a lactose
lactose

homogeneizado
homogenised

não pasteurizado
unpasteurized

o iogurte
congelado
frozen yogurt

sem sal
unsalted

o soro do leite
buttermilk

sem gordura
fat-free

o leite em pó
powdered milk

os pães e as farinhas • breads and flours

o pão fatiado
sliced bread

as sementes de papoila
poppy seeds

o pão de centeio
rye bread

a baguete
baguette



piekarnia | a padaria

fazendo pão • making bread



a farinha branca
white flour



a farinha com farelo
brown flour



a farinha integral
whole-wheat flour



o fermento
yeast



penear (v) | sift (v)



misturar (v) | mix (v)

a massa
dough



amassar (v) | knead (v)



cozer no forno (v) | bake (v)

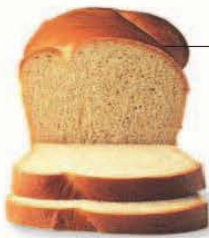

a crosta
crust

o pão branco
white bread



o pão de forma
loaf

o pão escuro
brown bread



o pão integral
whole-wheat bread

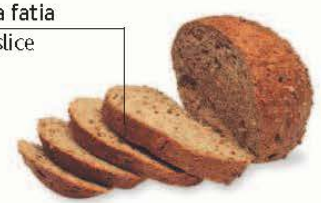

a fatia
slice

o pão granary
multigrain bread



o pão de milho
corn bread



o pão com bicarbonato de
soda
soda bread



o pão fermentado
sourdough bread



o pão sem levedura
flatbread



o bagel
bagel



o pãozinho de leite
bun



o pãozinho
roll



o pão de fruta
fruit bread



o pão com sementes
seeded bread

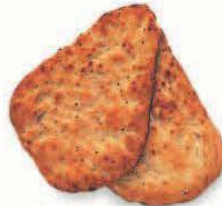

o pão naan
naan bread



o pão pitta
pita bread



o cracker
crispbread

vocabulário • vocabulary

a farinha para pão
bread flour

subir (v)
rise (v)

levedar (v)
prove (v)

o pão ralado
breadcrumbs

o fatiador
slicer

a farinha com
fermento
self-raising flour

a farinha sem
fermento
all-purpose
flour

pôr cobertura (v)
glaze (v)

o entalhe
flute

o padeiro
baker

os bolos e as sobremesas • cakes and desserts



os bolos | cakes

vocabulário • vocabulary

o creme pasteleiro
crème patisserie

o pãozinho doce
bun

a massa
pastry

o arroz doce
rice pudding

Pode dar-me uma fatia,
por favor?
May I have a slice, please?

o bolo de chocolate
chocolate cake

o creme
custard

a fatia
slice

a celebração
celebration



a pepita de chocolate
chocolate chip

os biscoitos de
champanhe
ladyfingers

a florentina
florentine

o pavê
trifle

as bolachas | cookies



a mousse
mousse



o sorvete
sherbet



a tarte de natas
cream pie



o pudim flan
crème caramel

os bolos para celebrações • celebration cakes



a camada de cima
top tier

a fita
ribbon

a camada de
baixo
bottom tier

a cobertura
icing

o maçapão
marzipan

o bolo de casamento | wedding cake



a decoração
decoration

as velas de
aniversário
birthday candles

soprar (v)
blow out (v)

o bolo de aniversário | birthday cake

a charcutaria • delicatessen

o enchido
picante
spicy sausage

o óleo
oil



o salame
salami

o pepperoni
pepperoni

o vinagre
vinegar

a carne fresca
uncooked meat

o balcão
counter

a quiche
flan

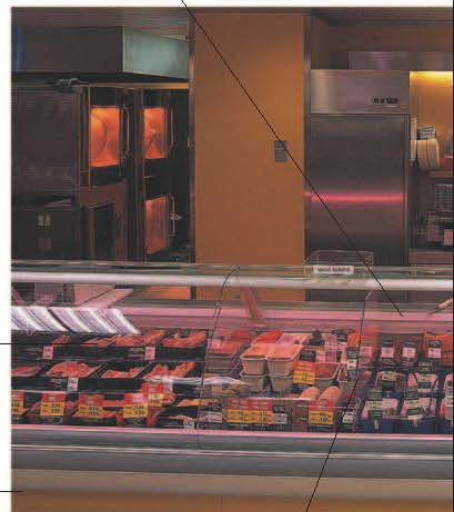

o pâté
pâté



o mozzarella
mozzarella



o brie
brie



o queijo de cabra
goat's cheese



o cheddar
cheddar



o parmesão
parmesan



o camembert
camembert

a casca
rind



o flamengo
edam



o manchego
manchego

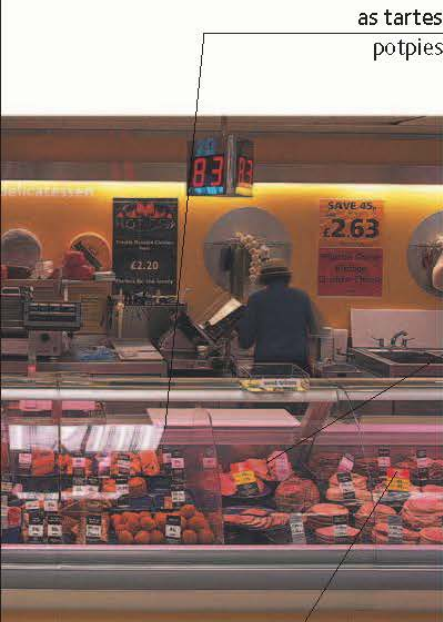

as tartes
potpies

o presunto
ham

o paposco
dinner roll

as carnes frias
cooked meat



a azeitona preta
black olive

a azeitona verde
green olive

a malagueta
chili pepper

o molho
sauce

o balcão de sanduíches | sandwich counter



o peixe fumado
smoked fish



as alcaparras
capers

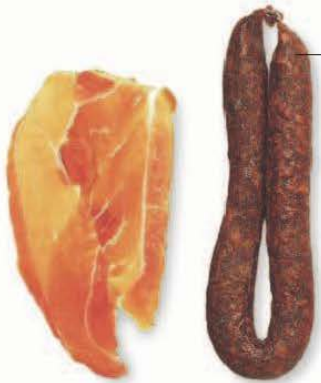

o presunto serrano
prosciutto

o chouriço
chorizo



a azeitona recheada
stuffed olive

vocabulário • vocabulary

em óleo
in oil

marinado
marinated

fumado
smoked

em salmoura
in brine

salgado
salted

curado
cured

Tire uma senha numerada, por favor.
Take a number, please.

Posso provar um pouco disto, por favor?
Can I try some of that, please?

Podia dar-me seis fatias desse?
May I have six slices of that, please?

as bebidas • drinks

a água • water



as bebidas quentes • hot drinks



os refrescos • soft drinks



as bebidas alcoólicas • alcoholic drinks



o gin | gin



a lata
can

a cerveja
beer



a sidra
hard cider



a cerveja amarga
bitter



a cerveja preta
stout



a vodka | vodka



o whisky | whisky



o rum
rum



o brandy
brandy



o porto
port



seco
dry

o xerez
sherry



o campari
bitters

rosé
rosé

branco
white

tinto
red



o licor
liqueur



a tequila
tequila



o champagne
champagne



o vinho | wine



LES CHAMPS CLOS
SANCERRE
1994



Bourguignon
145



comer fora
eating out

o café • café



a ementa
menu

o toldo
awning

o café com mesas fora | pavement café



o guarda-sol
umbrella

o café de esplanada
terrace café

o empregado
waiter

a máquina do café
coffee machine

a mesa
table



o snack-bar | snack bar

o café • coffee



o café com leite
white coffee

o café
black coffee

o cacau em pó
cocoa powder

a espuma
froth

o café de filtro
filter coffee

a bica
espresso

o cappuccino
cappuccino

o café com gelo
iced coffee

o chá • tea

o chá de infusão
herbal tea

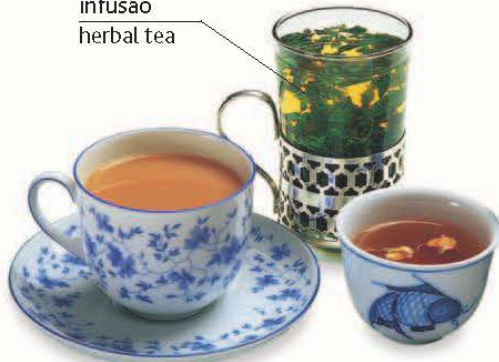

o chá com leite
tea with milk

o chá preto
black tea



o chá de camomila
chamomile tea



o chá verde
green tea



o chá com limão
tea with lemon



o chá de hortelã
mint tea



o iced tea
iced tea

os sumos e os batidos • juices and milkshakes



o sumo de laranja
orange juice



o sumo de maçã
apple juice



o sumo de ananás
pineapple juice



o sumo de tomate
tomato juice

o batido de chocolate
chocolate milkshake

o batido de morango
strawberry milkshake

o batido de café
coffee milkshake



a comida • food



a sanduíche torrada
toasted sandwich

o pão escuro
brown bread



a salada
salad



o gelado
ice cream

a bola
scoop



o folhado
pastry

o bar • bar

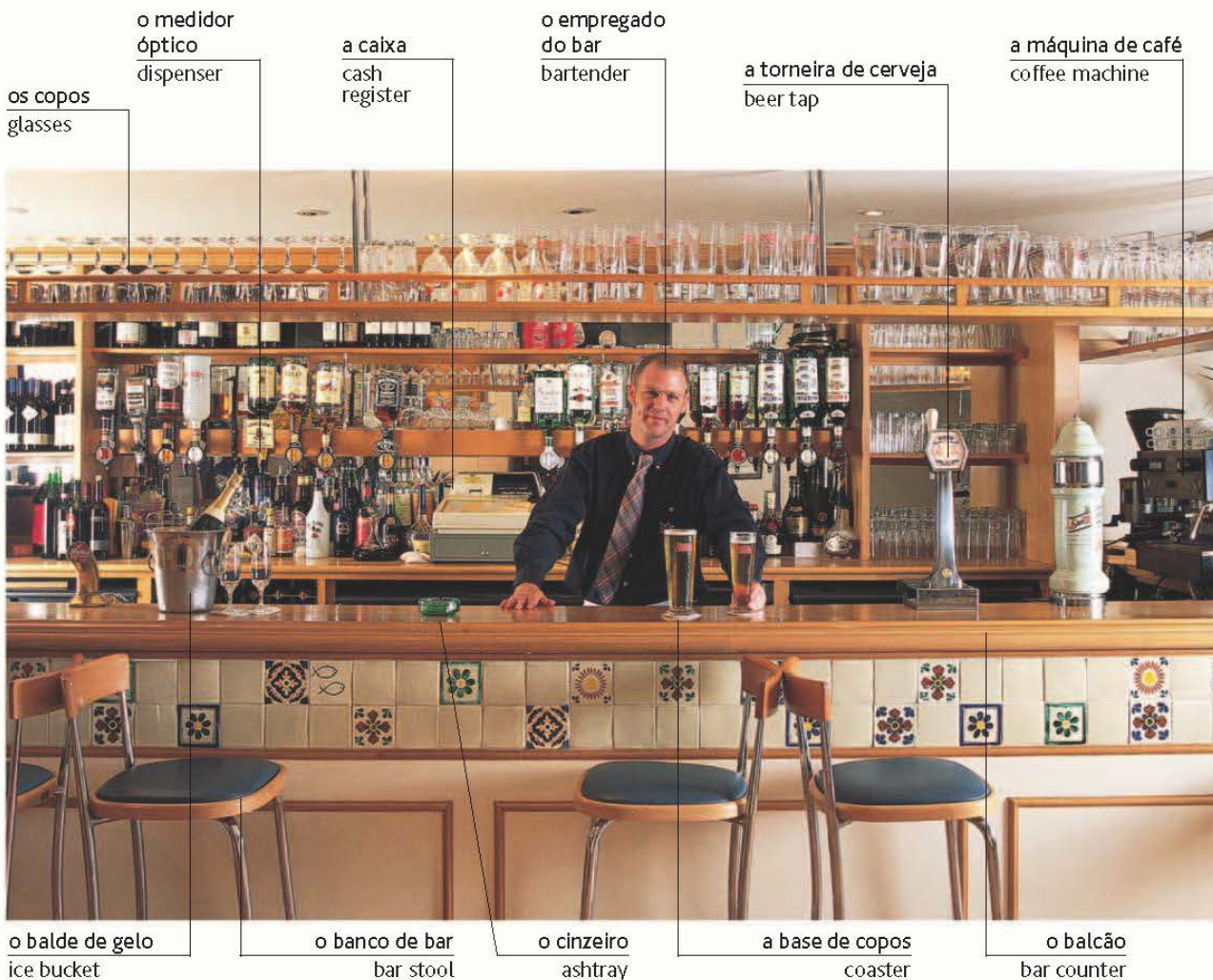

o descapsulador
bottle opener

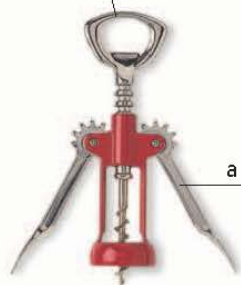

o saca-rolhas | corkscrew

a alavanca
lever

a pinça
tongs



o shaker | cocktail shaker

o agitador
stirrer

a medida
measure



o gin tónico
gin and tonic

o jarro
pitcher



o whisky escocês com água
scotch and water



o cubo de gelo
ice cube

o rum com cola
rum and coke



a vodka com laranja
screwdriver



o martini
martini



o cocktail
cocktail



o vinho
wine



a cerveja
beer



um shot
a shot

simples
single



uma medida
measure

duplo
double



sem gelo
without ice

gelo e limão
ice and lemon



com gelo
with ice

os aperitivos • bar snacks



as batatas fritas | chips

os cajus
cashewnuts

as amêndoas
almonds

os amendoins
peanuts



os frutos secos | nuts



as azeitonas | olives

o restaurante • restaurant

a área de não fumadores
nonsmoking section

o guardanapo
napkin

o ajudante do chefe
commis chef



o lugar posto na mesa
table setting

o chefe de cozinha
chef

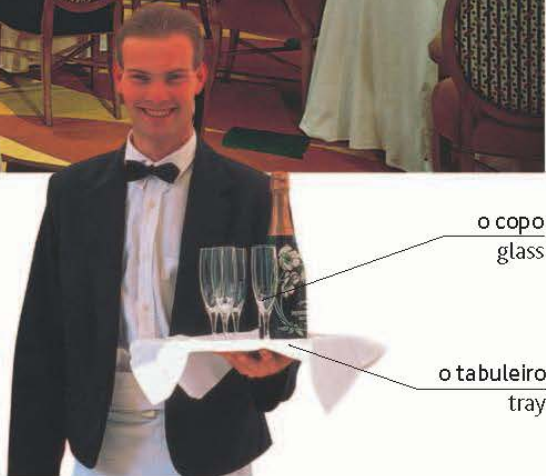

o copo
glass

o tabuleiro
tray

a cozinha | kitchen

o empregado | waiter

vocabulário • vocabulary

a ementa do jantar
evening menu

os pratos do dia
specials

o preço
price

a gorjeta
tip

o buffet
buffet

o cliente
customer

a carta de vinhos
wine list

à la carte
à la carte

a conta
check

serviço incluído
service included

o bar
bar

o sal
salt

a ementa do almoço
lunch menu

o carrinho das sobremesas
dessert cart

o recibo
receipt

serviço não incluído
service not included

a área de fumadores
smoking section

a pimenta
pepper



a ementa
menu



a refeição para crianças
child's meal



pedir (v) | order (v)



pagar (v) | pay (v)

os pratos • courses



o aperitivo
apéritif



a entrada
starter



a sopa
soup



o prato principal
main course



o acompanhamento
side order

o garfo
fork



a sobremesa | dessert

a colher de café
coffee spoon



o café | coffee

Uma mesa para dois, por favor.
A table for two please.

Podia ver a ementa/carta de vinhos,
por favor?
Can I see the menu/winelist please?

Há uma ementa de preço fixo?
Is there a fixed price menu?

Tem alguns pratos vegetarianos?
Do you have any vegetarian dishes?

Podia trazer-me a conta/o recibo,
por favor?
Could I have the check/a receipt please?

Podemos pagar separadamente?
Can we have separate checks?

Onde ficam as casas de banho?
Where are the restrooms, please?

a comida rápida • fast food

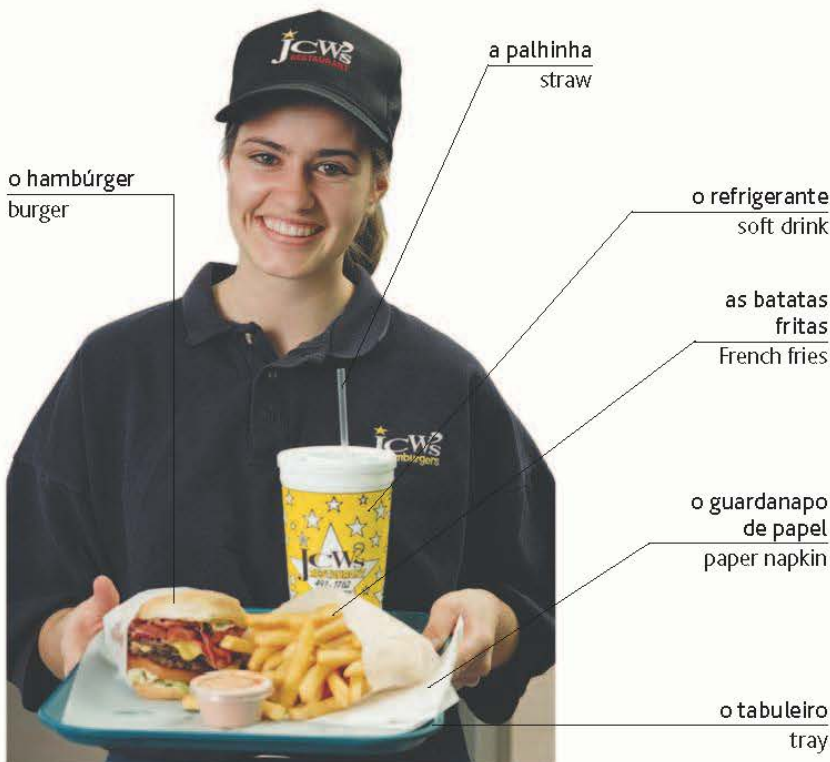

a refeição de hambúrguer | burger meal



a entrega em casa | home delivery

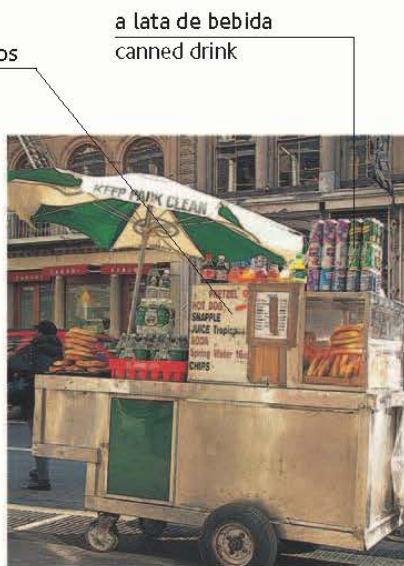

a tenda de rua | street stand

vocabulário • vocabulary

a pizzeria
pizzeria

a hamburgueria
burger bar

a ementa
menu

para comer no estabelecimento
eat-in

para levar
carry-out

reaquecer (v)
reheat (v)

o molho de tomate
ketchup

Posso comprar para levar?
Can I have that to go, please?

Entrega em casa?
Do you deliver?



o hambúrguer
hamburger

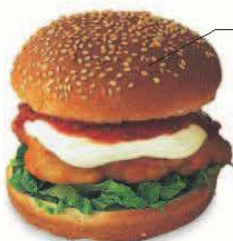

o hambúrguer de frango
chicken patty



o hambúrguer vegetariano
veggie burger

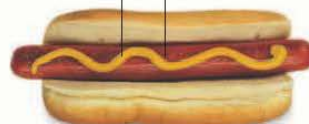

o cachorro quente | hot dog

o pãozinho
bun

a mostarda
mustard

a salsicha
sausage



a sanduíche
sandwich



a sanduíche club
club sandwich



a sanduíche aberta
open-face sandwich

o recheio
filling



o taco
wrap



a espetada
kebab

o molho
sauce



os nuggets de frango
chicken nuggets

salgado
savoury



os crepes | crêpes



doce
sweet

a cobertura
topping



o peixe e as batatas fritas
fish and chips



o entrecosto
ribs



o frango frito
fried chicken



a pizza
pizza

o pequeno-almoço • breakfast



a mesa do pequeno-almoço | breakfast table



as bebidas | drinks



o brioche
brioche



o pão
bread

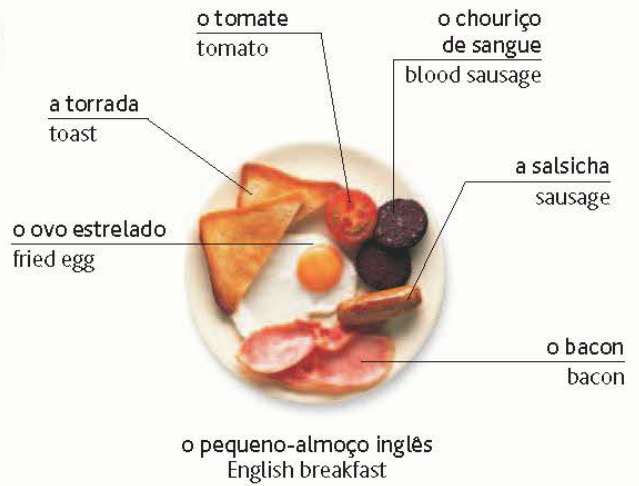

os arenques fumados
kippers



a tosta
french toast

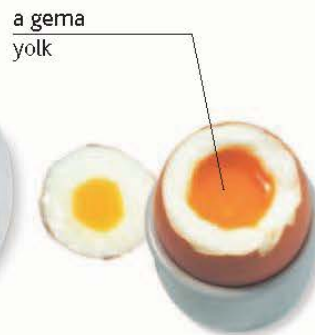

os ovos mexidos
scrambled eggs



as panquecas
pancakes

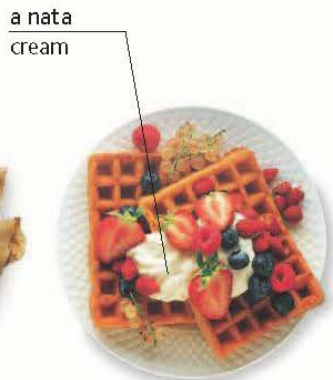

as waffles
waffles



as papas de aveia
oatmeal

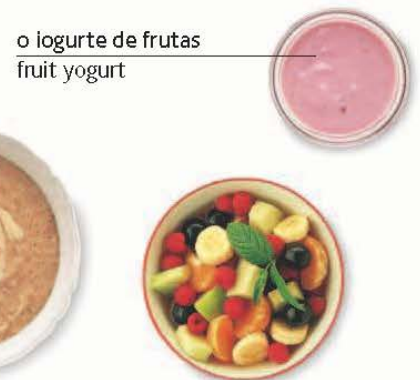

a fruta fresca
fresh fruit

o jantar • dinner



a sopa | soup



o consommé | broth



o estufado | stew



o caril | curry



o assado | roast



a tarte | potpie



o soufflé | soufflé



a espetada | kebab



as bolas de carne | meatballs



a omelete | omelette



a comida frita chinesa
stir-fry



a massa chinesa
noodles



a massa | pasta



o arroz | rice



a salada mista | tossed salad



a salada verde | green salad



o tempero de salada
dressing

as técnicas • techniques



recheado | stuffed



em molho | in sauce



grelhado | grilled



marinado | marinated



escalfado | poached



em puré | mashed



cozido no forno | baked



frito com pouco óleo | pan-fried



frito | fried



em vinagre | pickled



fumado | smoked

frito imerso em óleo
deep-fried

em calda | in syrup



temperado | dressed



ao vapor | steamed



curado | cured





o estudo
study

a escola • school

o professor
teacher

o quadro
(preto)
blackboard



a sala de aula | classroom



o aluno | schoolboy

o estudante
pupil

o uniforme
escolar
school uniform

a secretária
desk

o giz
chalk



a aluna
schoolgirl

vocabulário • vocabulary

a história
history

as ciências
science

a física
physics

as línguas
languages

a arte
art

a química
chemistry

a literatura
literature

a música
music

a biologia
biology

a geografia
geography

a matemática
math

a educação
física
physical
education

as actividades • activities



ler (v) | read (v)



escrever (v) | write (v)



soletrar (v) | spell (v)



desenhar (v) | draw (v)



o retroprojector
overhead projector



a caneta
pen



o lápis
pencil



o lápis de cor
colored pencil

o apara-lápis
pencil
sharpener



a borracha
eraser



o caderno
notebook

o manual | textbook



o estojo de lápis | pencil case

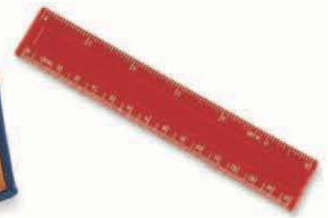

a régua | ruler



perguntar (v) | question (v)



responder (v) | answer (v)



discutir (v) | discuss (v)



aprender (v) | learn (v)

vocabulário • vocabulary

o director
principal

a resposta
answer

a nota
grade

a aula
lesson

o trabalho de
casa
homework

o ano
year

a pergunta
question

o exame
test

o dicionário
dictionary

tirar
apontamentos
(v)
take notes (v)

a redacção
essay

a enciclopédia
encyclopedia

a matemática • math

as formas • shapes

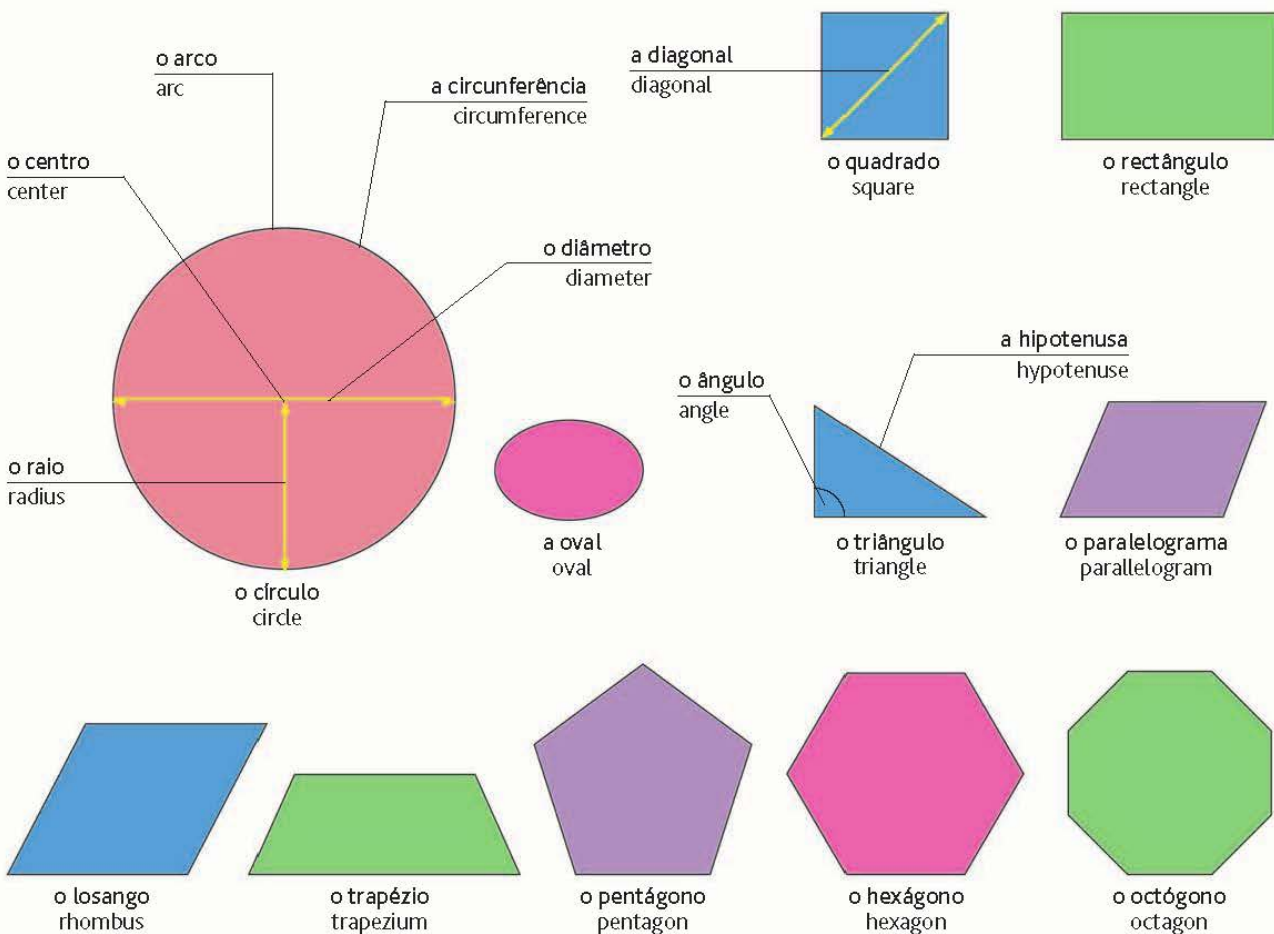

os sólidos • solids

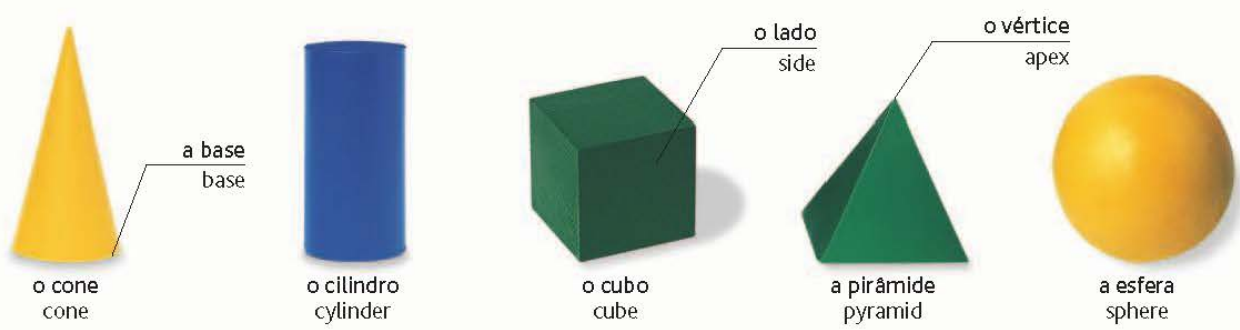

as linhas • lines

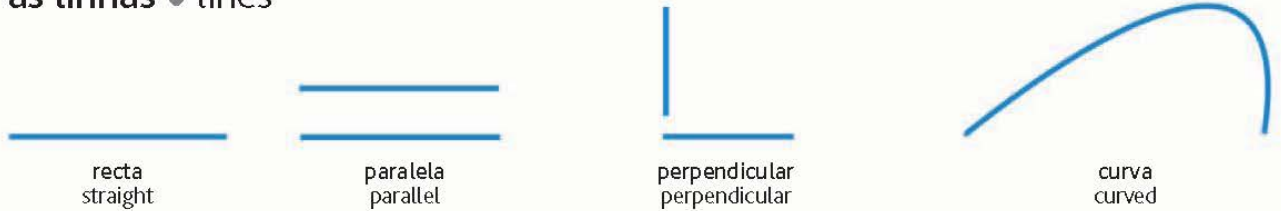

as medidas • measurements

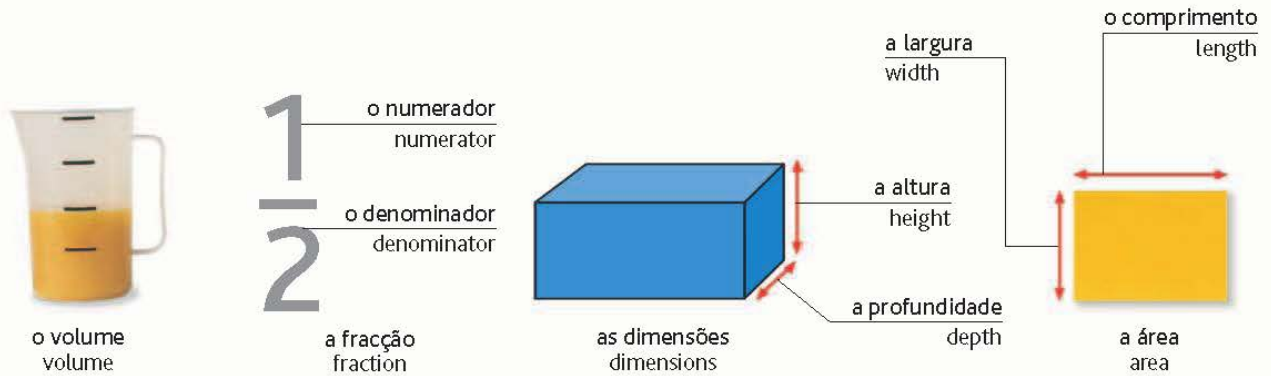

o equipamento • equipment

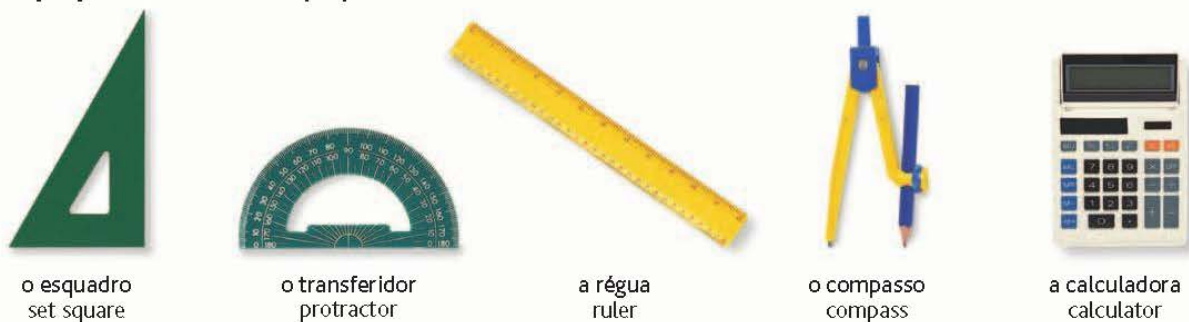

vocabulário • vocabulary

a geometria geometry	mais plus	vezes times	é igual a equals	somar (v) add (v)	multiplicar (v) multiply (v)	a equação equation
a aritmética arithmetic	menos minus	dividido por divided by	contar (v) count (v)	subtrair (v) subtract (v)	dividir (v) divide (v)	a percentagem percentage

as ciências • science



o laboratório
laboratory

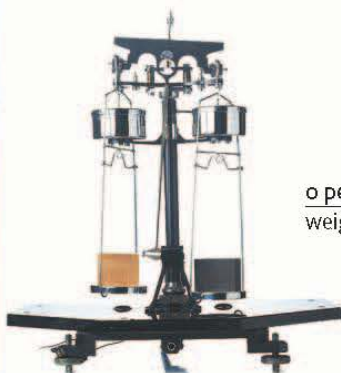

a balança
scales



o peso
weight

a balança de mola
spring balance

o cadinho
crucible



o bico de Bunsen
bunsen burner

o tripé
tripod

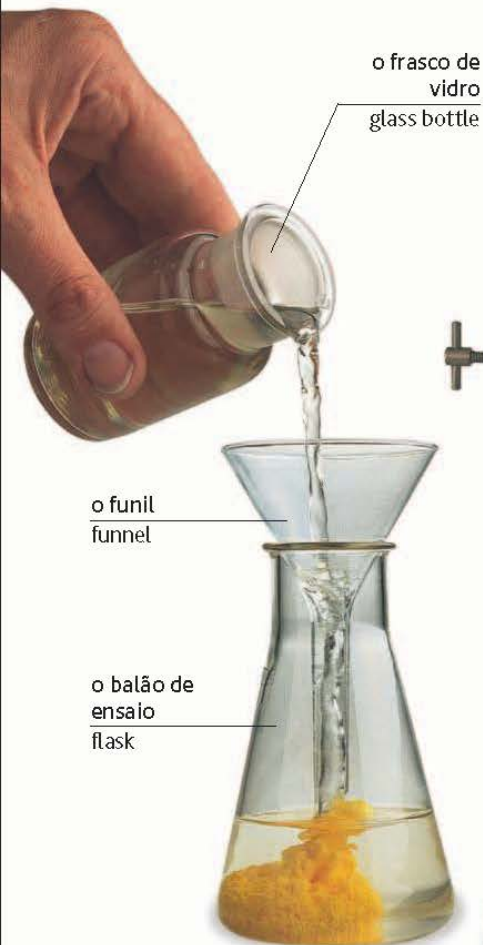

o frasco de
vidro
glass bottle

o funil
funnel

o balão de
ensaio
flask

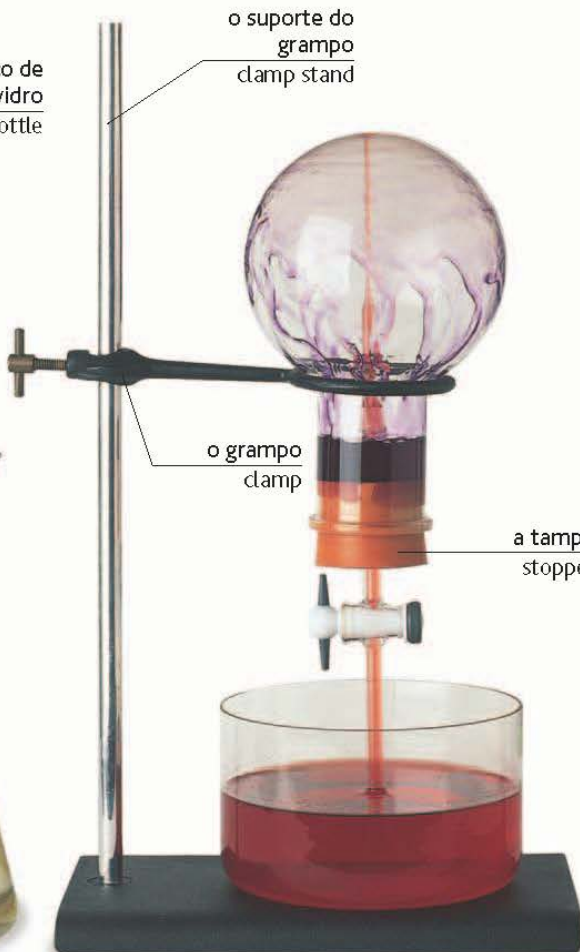

o suporte do
grampo
clamp stand

o grampo
clamp

a tampa
stopper

a experiência | experiment

o tubo de ensaio
test tube



o suporte
rack



o cronómetro
timer



a caixa de Petri
petri dish



o termómetro
thermometer



a seringa
syringe



a pinça
tweezers



o bisturi
scalpel



o conta-gotas | dropper



o forcéps | forceps



a tenaz | tongs



a espátula | spatula

o pilão
pestle



o almofariz
mortar



o filtro de papel
filter paper



os óculos de segurança
safety goggles

a ocular
eyepiece

o botão de ajuste
focusing knob



o microscópio | microscope

a lente da
objectiva
objective lens

a platina
stage

a lâmina
slide

o espelho
mirror



a vareta de vidro
glass stirring rod



o copo de laboratório
beaker

a pipeta
pipette



o íman
magnet



o jacaré
crocodile clip

o eléctrodo
negativo
negative
electrode



a pilha | battery

o eléctrodo
positivo
positive
electrode

o ensino superior • college



a secretaria
admissions

o refeitório
dining hall

o centro de saúde
health center

o campo de
desportos
playing field

a residência
universitária
residence hall

o catálogo
card catalog

o campus | campus

vocabulário • vocabulary

o cartão da
biblioteca
library card

a sala de leitura
reading room

a lista de leitura
reading list

a data de
devolução
return date

a informação
help desk

pedir
empréstado (v)
borrow (v)

reservar (v)
reserve (v)

renovar (v)
renew (v)

o empréstimo
loan

o livro
book

o título
title

o corredor
aisle

o balcão de
empréstimos
circulation desk

a prateleira
bookshelf

o periódico
periodical

o periódico
specializado
journal

a bibliotecária
librarian



a biblioteca | library

o estudante
universitário
undergraduate

o professor
universitário
lecturer



o anfiteatro | lecture hall

a licenciada
graduate

a toga
robe



a cerimónia de graduação | graduation ceremony

as escolas • schools



a modelo
model

a escola de Belas Artes | art college



o conservatório | music school



a academia de dança | dance academy

vocabulário • vocabulary

a bolsa de estudos
scholarship

a investigação
research

a dissertação
dissertation

a medicina
medicine

a filosofia
philosophy

o diploma
diploma

o mestrado
master's

o departamento
department

a zoologia
zoology

a literatura
literature

o grau
degree

o doutoramento
doctorate

o direito
law

a física
physics

a história da arte
art history

o pós-graduado
postgraduate

a tese
thesis

a engenharia
engineering

a política
politics

a economia
economics

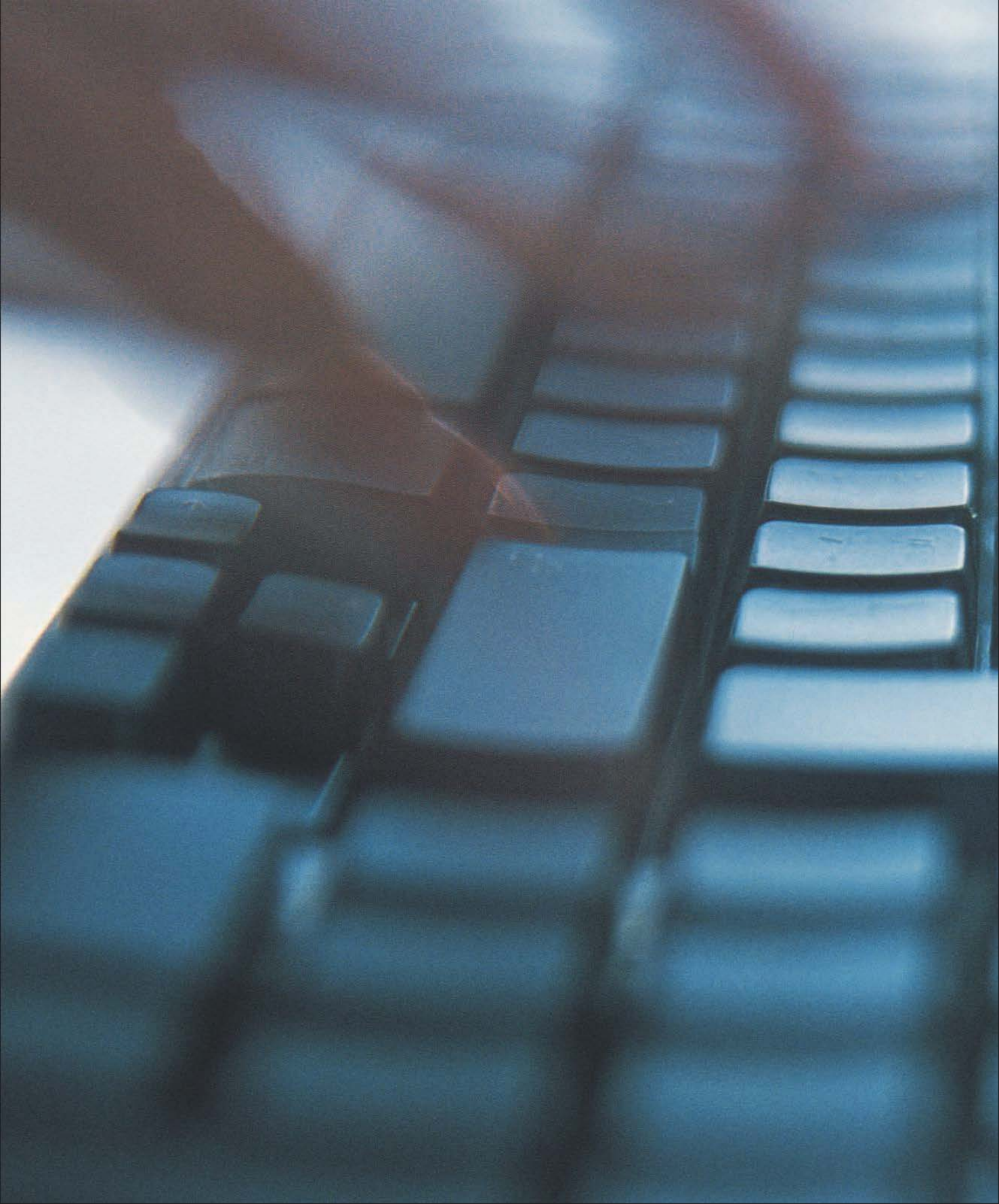

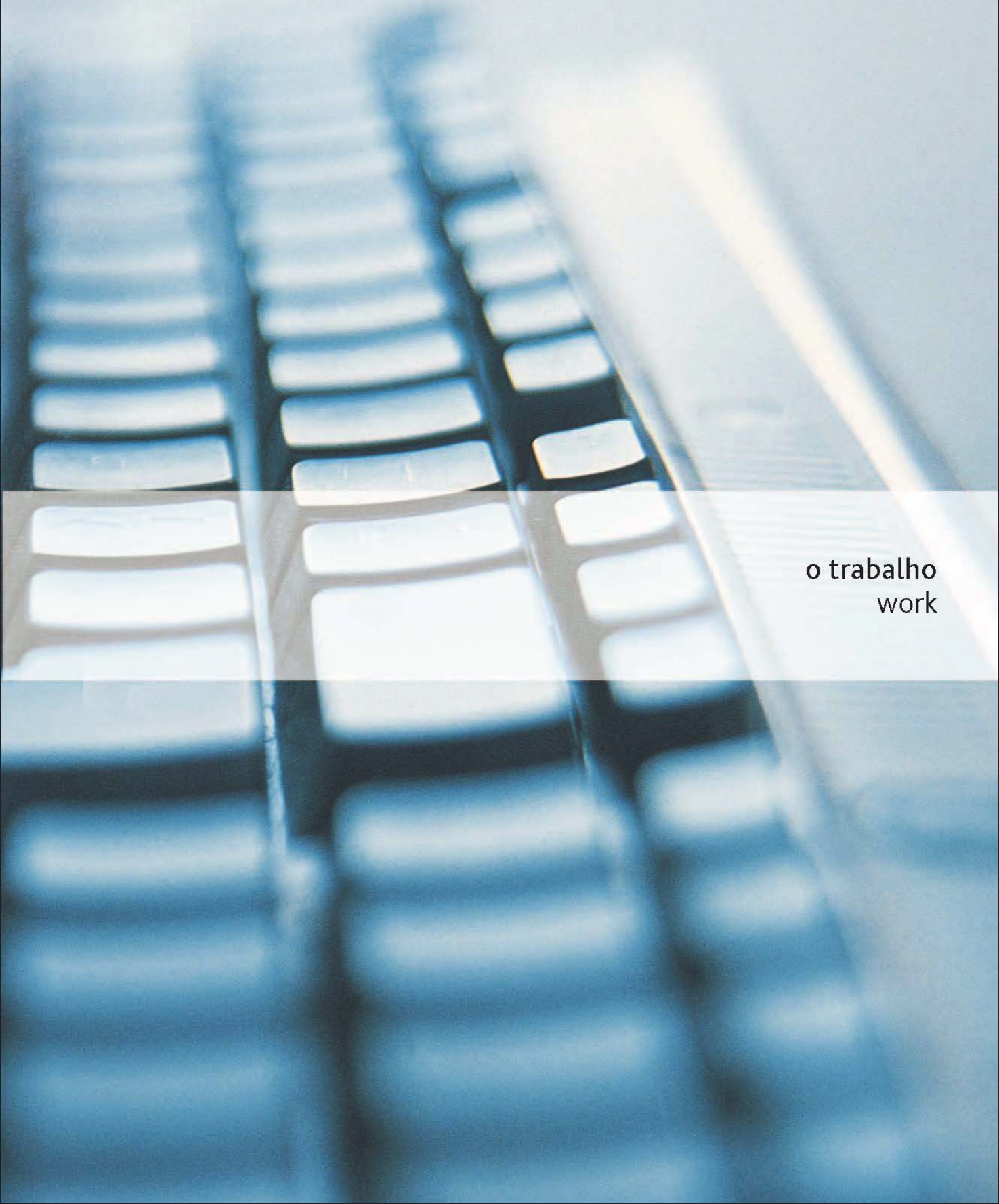

o trabalho
work

o escritório 1 • office 1

o escritório • office



o equipamento de escritório • office equipment

o tabuleiro de papel
paper tray

a guia do papel
paper guide

o fax
fax



a impressora | printer



a máquina de fax | fax machine

vocabulário • vocabulary

imprimir (v)
print (v)

ampliar (v)
enlarge (v)

fotocopiar (v)
copy (v)

reduzir (v)
reduce (v)

Preciso de fazer umas fotocópias.
I need to make some copies.

office supplies • os materiais de escritório



a nota de cumprimentos
notecard

o papel timbrado
letterhead



o envelope
envelope

a caixa de arquivo
box file



a prancheta de mola
clipboard

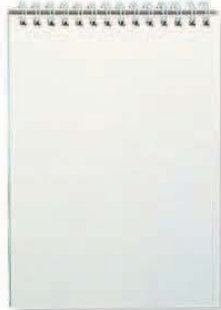

o bloco de apontamentos
note pad



a etiqueta
tab

a pasta suspensa
hanging file

o separador
divider



o arquivador em concertina
accordion file

o dossiê de argolas
binder



a agenda organiser
personal organizer

os agrafos
staples



o agrafador
stapler

a fita adesiva
adhesive tape

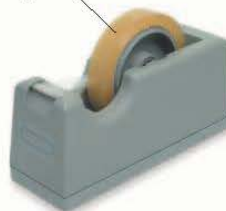

o desenrolador de fita adesiva
tape dispenser



o perfurador
hole punch

a almofada de tinta
ink pad



o carimbo de borracha
rubber stamp



o elástico
rubber band



a mola para papel
bulldog clip



o clip
paper clip

o alfinete
push pin



o quadro de avisos | notice board

o escritório 2 • office 2

o quadro de conferência
flipchart

a acta
minutes

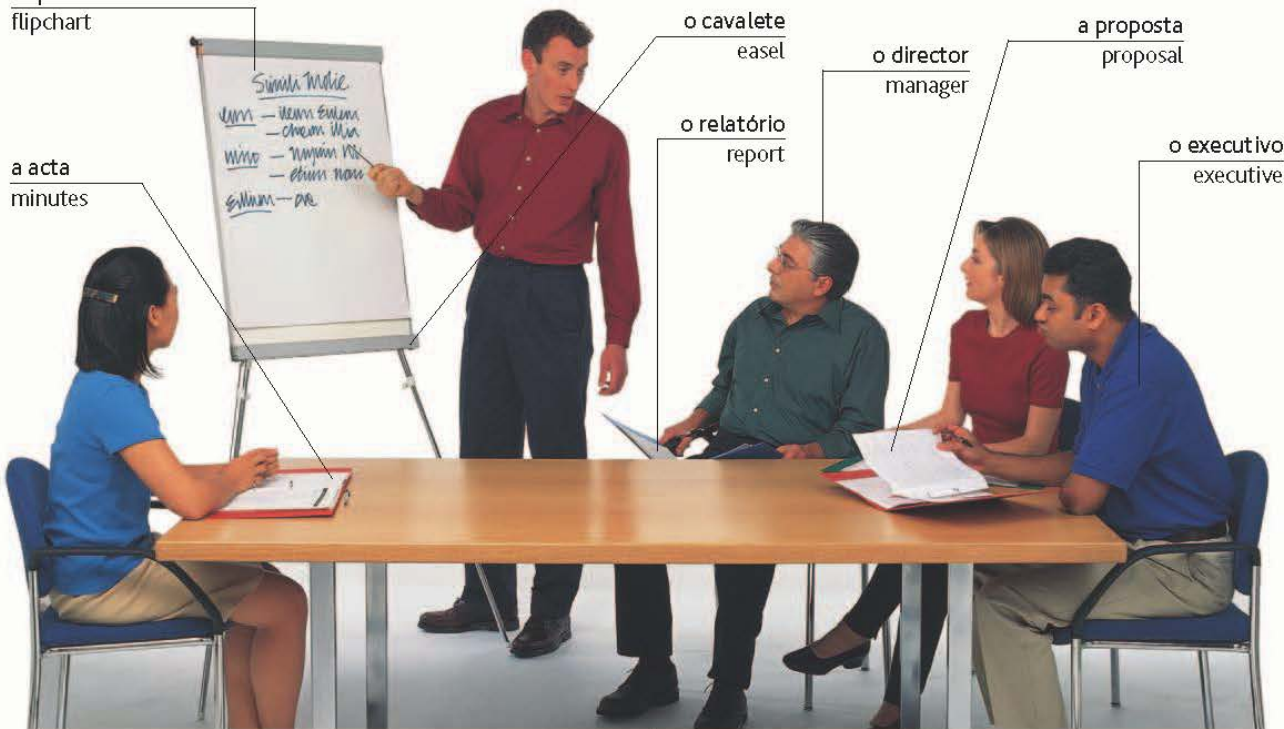

o cavalete
easel

o relatório
report

o director
manager

a proposta
proposal

o executivo
executive

a reunião | meeting

vocabulário • vocabulary

a sala de reuniões
meeting room

participar (v)
attend (v)

a ordem de trabalhos
agenda

presidir (v)
chair (v)

A que horas é a reunião?
What time is the meeting?

Quais são as suas horas de trabalho?
What are your office hours?

o retroprojector
projector

o orador
speaker



a apresentação | presentation

os negócios • business

o laptop
laptopas notas
notes

o almoço de negócios | business lunch

o homem de negócios
businessmana mulher de negócios
businesswoman

a viagem de negócios | business trip



a agenda | diary

o cliente
clienta marcação
appointmento PDA
palmtopo director-geral
managing
director

o acordo comercial | business deal

vocabulário • vocabulary

a empresa
companyo pessoal
staffo departamento de
contabilidade
accounts departmento departamento jurídico
legal departmenta sede
headquarterso salário
salaryo departamento de
marketing
marketing departmento departamento de atendimento
ao cliente
customer service departmenta filial
brancha folha de
pagamentos
payrollo departamento de vendas
sales departmento departamento de pessoal
human resource department

o computador • computer



o hardware
hardware



a disquete | disk



o laptop | laptop

vocabulário • vocabulary		
a memória memory	o software software	o servidor server
a RAM RAM	a aplicação application	a porta port
os bytes bytes	o programa program	o processador processor
o sistema system	a rede network	o cabo de alimentação power cable

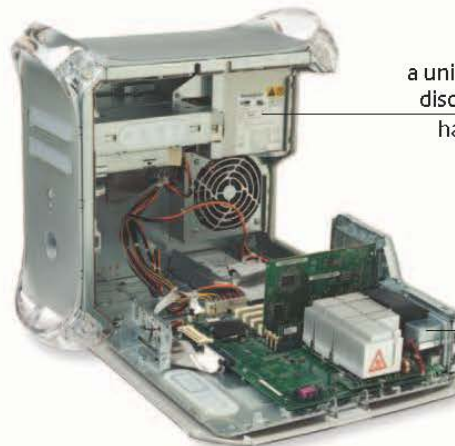

a unidade de disco rígido
hard drive

o modem
modem

o computador de secretária • desktop

a barra do menu
menubar

a barra de
ferramentas
toolbar

o wallpaper
wallpaper

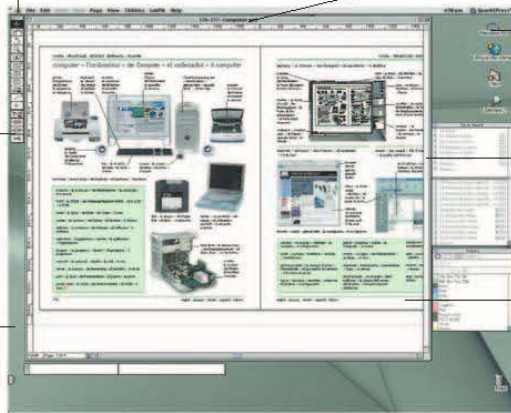

a fonte
font

o ícone
icon

a barra de deslocamento
scrollbar

a janela
window



a internet • internet



o programa de
navegação
browser

pasta a
receber
inbox

o site da internet
website

navegar (v) | browse (v)

o e-mail • email

a morada de e-mail
email address

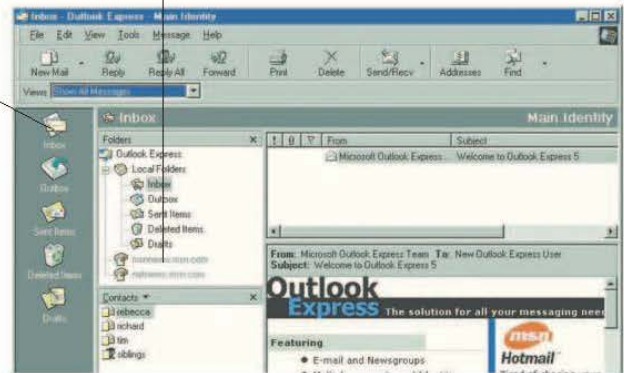

vocabulário • vocabulary

ligar (v)
connect (v)

o fornecedor de serviços
service provider

fazer log-in (v)
log on (v)

fazer download
download (v)

enviar (v)
send (v)

guardar (v)
save (v)

instalar (v)
instal (v)

a conta de e-mail
email account

on-line
online

o anexo
attachment

receber (v)
receive (v)

procurar (v)
search (v)

os meios de comunicação social • media

o estúdio de televisão • television studio

o apresentador
presenter

a iluminação
light

o plateau
set



a câmara
camera

a grua da câmara
camera crane

o operador de câmara
camera operator

vocabulário • vocabulary

o canal
channel

as notícias
news

a imprensa
press

a telenovela
soap

os desenhos animados
cartoon

em directo
live

a programação
programming

o documentário
documentary

a série televisiva
series

o concurso
game show

em diferido
pre-recorded

transmitir (v)
broadcast (v)



o entrevistador | interviewer



o repórter | reporter



o teleprompter | teleprompter



a apresentadora do telejornal | newsreader



os actores | actors



a girafa | sound boom

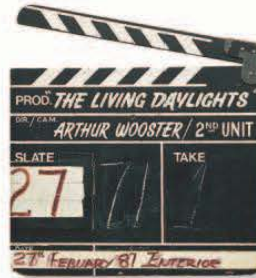

a claquete | clapper board



o plateau de rolagem
movie set

a rádio • radio

a mesa de
mistura
mixing desk

o microfone
microphone

o técnico de som
sound technician



o estúdio de gravação | recording studio

vocabulário • vocabulary

a estação de rádio
radio station

a frequência
frequency

o disco-jóquei
DJ

o volume
volume

a transmissão
broadcast

sintonizar (v)
tune (v)

o comprimento
de onda
wavelength

a onda curta
short wave

a onda larga
long wave

a onda média
medium wave

a lei • law

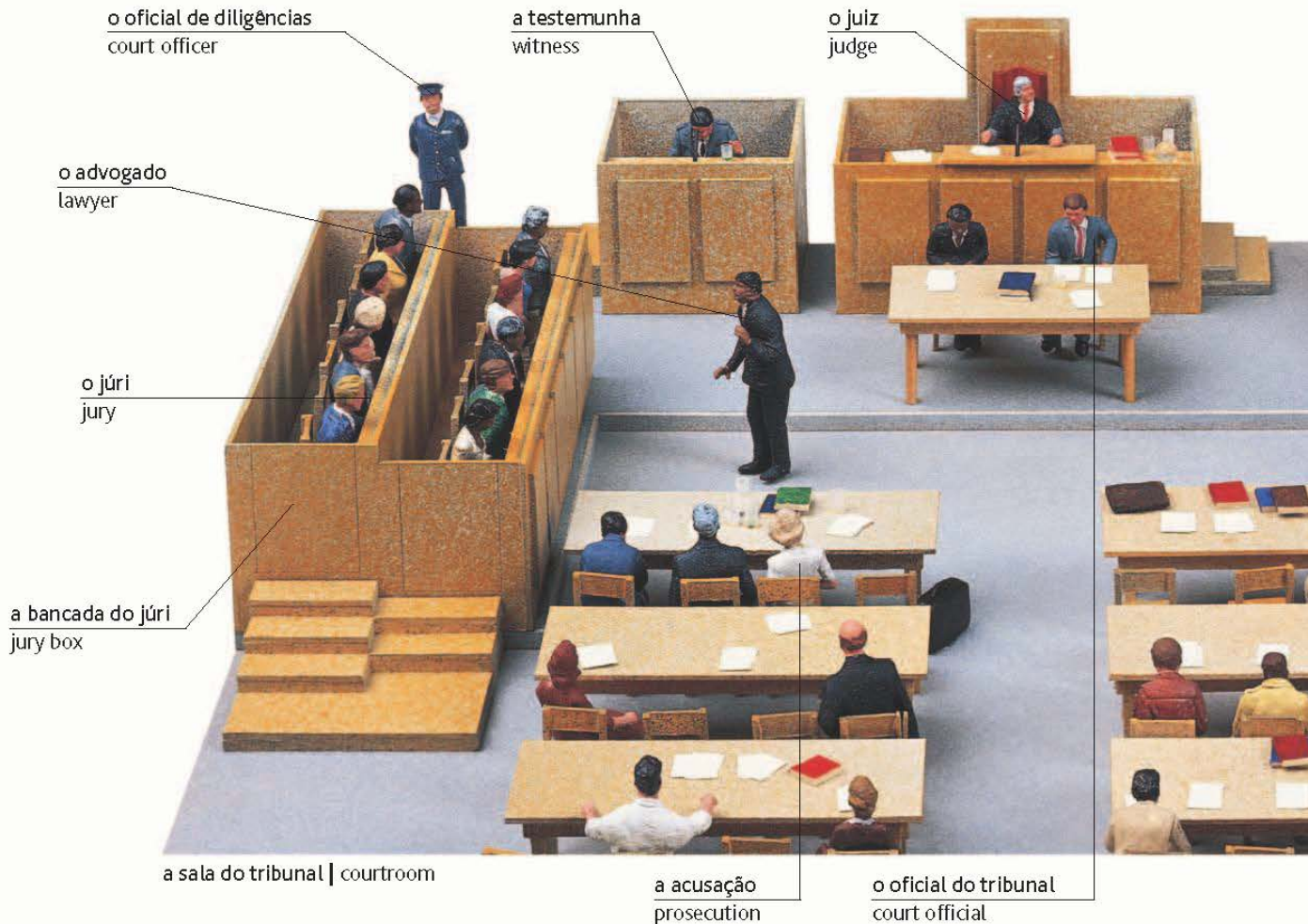

vocabulário • vocabulary

o escritório do advogado
lawyer's office

a citação
summons

a ordem judicial
writ

o processo de
tribunal
court case

a assessoria jurídica
legal advice

a declaração
statement

a data do julgamento
court date

a acusação
charge

o cliente
client

o mandado
warrant

a alegação do arguido
plea

o acusado
accused

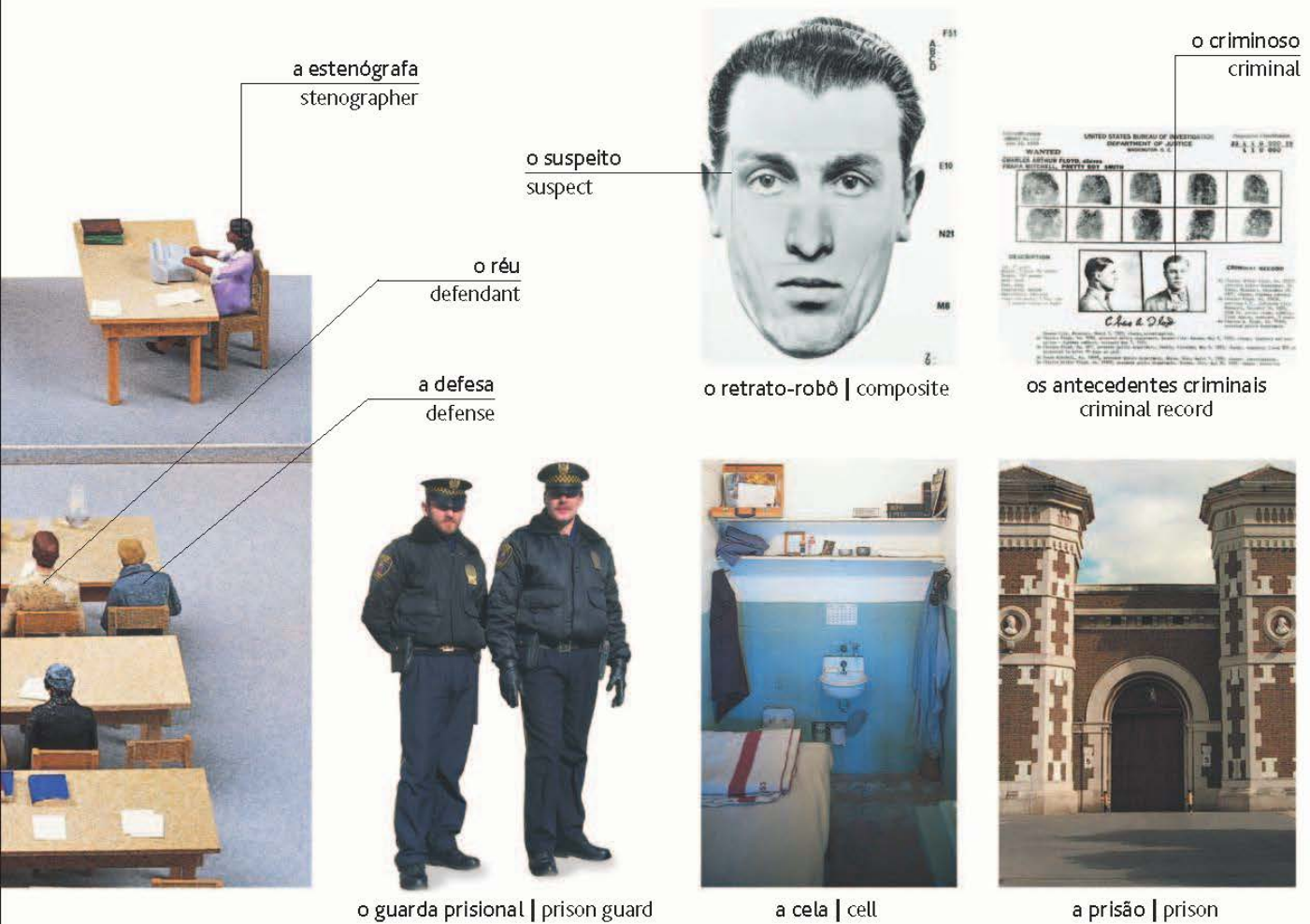

a estenógrafa
stenographer

o suspeito
suspect

o criminoso
criminal

o réu
defendant

a defesa
defense

o retrato-robô | composite

os antecedentes criminais
criminal record

o guarda prisional | prison guard

a cela | cell

a prisão | prison

vocabulário • vocabulary

a prova
evidence

culpado
guilty

a caução
bail

Quero falar com um
advogado.
I want to see a lawyer.

o veredicto
verdict

absolvido
acquitted

o recurso
appeal

Onde fica o tribunal?
Where is the courthouse?

inocente
innocent

a sentença
sentence

a liberdade condicional
parole

Posso pagar uma caução?
Can I post bail?

a quinta 1 • farm 1



o agricultor
farmer

a horta
vegetable garden

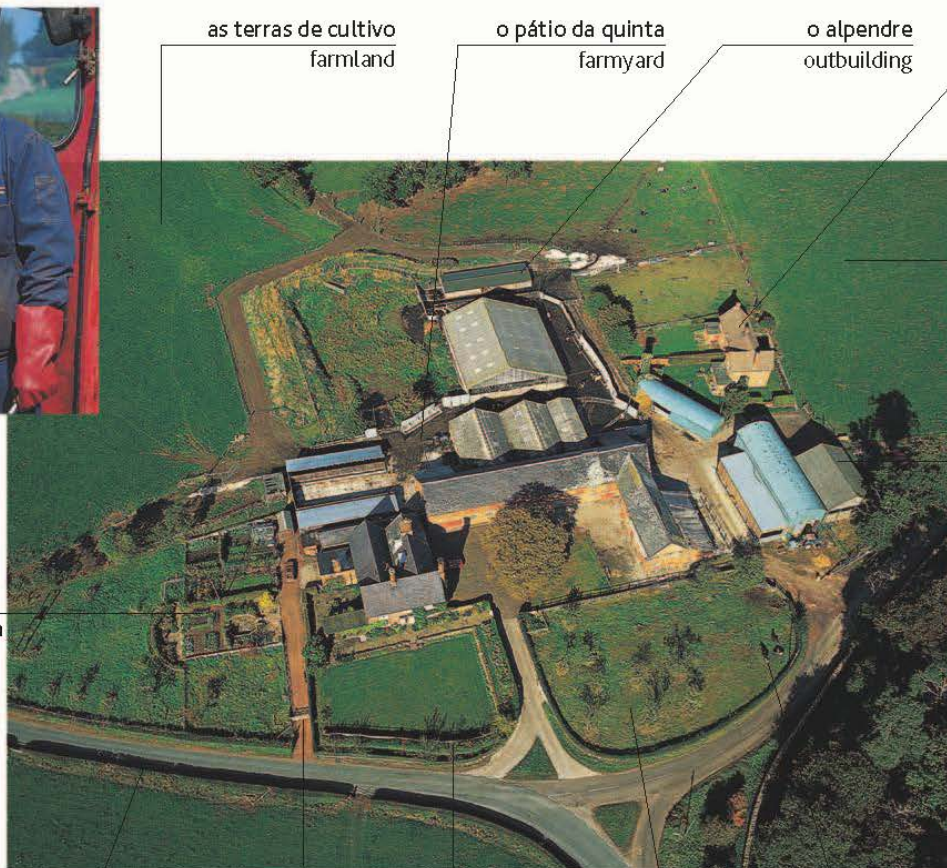

a sebe
hedge

o portão
gate

a vedação
fence

a pastagem
pasture

o gado
livestock



o tractor | tractor



o cultivador
cultivator

a ceifeira-debulhadora | combine

os tipos de quinta • types of farm

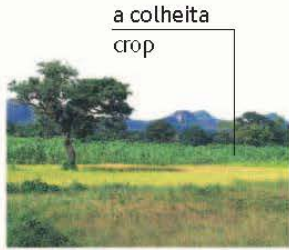

a colheita
crop

a quinta de terras aráveis
crop farm



a exploração leiteira
dairy farm



o rebanho
flock

a criação de gado ovino
sheep farm



a criação de aves
poultry farm



a criação de suínos
pig farm



a exploração piscícola
fish farm



a exploração frutícola
fruit farm

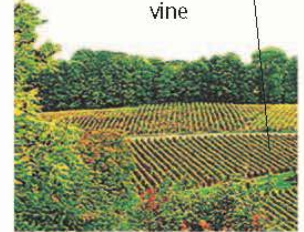

a videira
vine

a vinha
vineyard

as actividades • actions



o sulco
furrow

lavar (v)
plow (v)



semear (v)
sow (v)



ordenhar (v)
milk (v)

dar de comer (v)
feed (v)

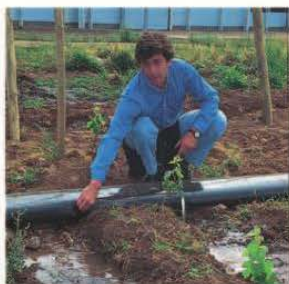

regar (v) | water (v)

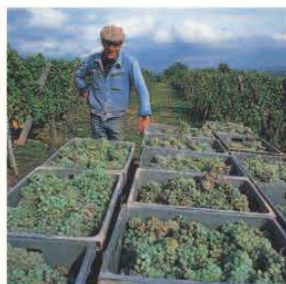

colher (v) | harvest (v)

vocabulário • vocabulary

o herbicida
herbicide

o rebanho
herd

o comedouro
trough

o pesticida
pesticide

o silo
silo

plantar (v)
plant (v)

a quinta 2 • farm 2

as colheitas • crops



o trigo
wheat



o milho
corn



a cevada
barley



a colza
rapeseed



o girassol
sunflower



o fardo
bale

o feno
hay



a alfafa
alfalfa



o tabaco
tobacco



o arroz
rice



o chá
tea

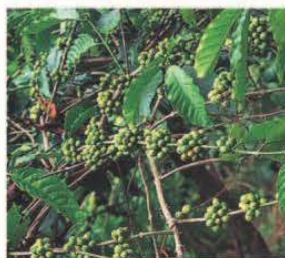

o café
coffee



o linho
flax



a cana-de-açúcar
sugarcane



o algodão
cotton



o espantalho
scarecrow

o gado • livestock



o leitão
piglet

o porco
pig



a vitela
calf

a vaca
cow



o touro
bull



a ovelha
sheep



o cordeiro
lamb



o cabrito
kid

a cabra
goat



o potro
foal

o cavalo
horse



o burro
donkey



o pintainho
chick

a galinha
chicken



o galo
rooster



o peru
turkey

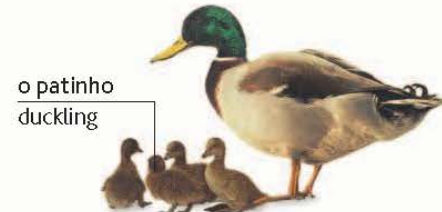

o patinho
duckling

o pato
duck



o estábulo
stable



o redil
pen

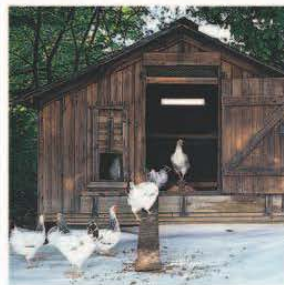

o galinheiro
chicken coop



a pocilga
pigsty

a construção • construction

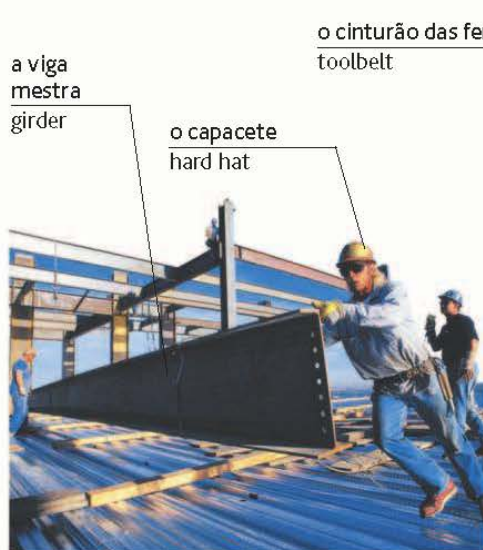
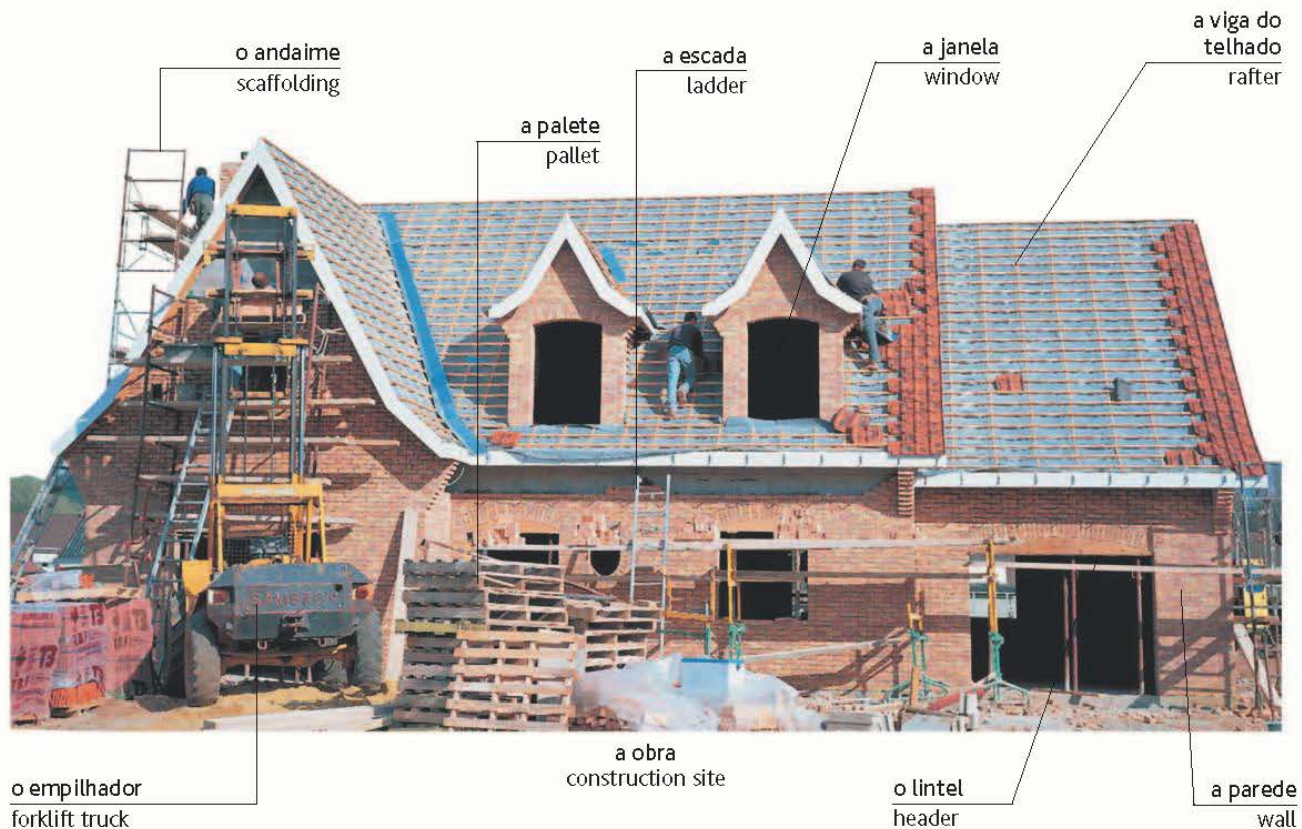

construir (v)
build (v)



o construtor
construction worker



os materiais • materials

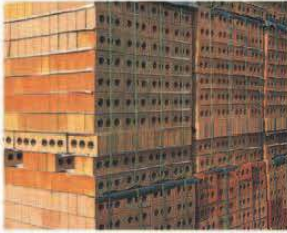

o tijolo
brick



a madeira
timber



a telha
roof tile



o bloco de betão
concrete block

as ferramentas • tools

a argamassa
mortar



a colher de pedreiro
trowel



o nível de bolha de ar
level



a marreta
sledgehammer



o cabo
handle

a picareta
pickax



a pá
shovel

a maquinaria •
machinery



o cilindro
roller



o camião basculante
dump truck

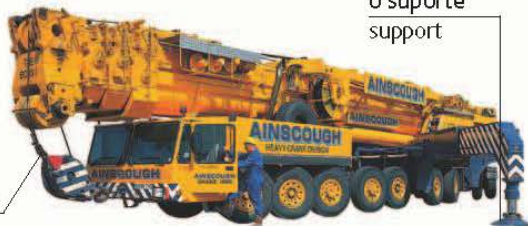

o gancho
hook

o suporte
support

a grua | crane

as obras na estrada • roadworks

o alcatrão
tarmac

o cone
cone



a britadeira
pneumatic drill

a repavimentação
resurfacing



a escavadora
mecânica
mechanical digger

as profissões 1 • occupations 1



o carpinteiro
carpenter



o electricista
electrician



o canalizador
plumber



o construtor
construction worker



o jardineiro
gardener

o aspirador
vacuum
cleaner



o empregado da limpeza
cleaner



o mecânico
mechanic



o talhante
butcher

a tesoura
scissors



o cabeleireiro
hair stylist



a peixeira
fishmonger



o vendedor de frutas e
legumes | greengrocer



a florista
florist



o barbeiro
barber



o joalheiro
jeweler



a empregada da loja
store clerk



a agente imobiliária
real estate agent



o oftalmologista
optician



a dentista
dentist

a máscara
mask



o médico
doctor



a farmacêutica
pharmacist



a enfermeira
nurse



a veterinária
veterinarian



o agricultor
farmer



o pescador
fisherman

a metralhadora
machine-gun



o soldado
soldier



o polícia
policeman

o crachá de
identificação
identity badge



o guarda de segurança
security guard

o uniforme
uniform



o marinheiro
sailor



o bombeiro
firefighter

as profissões 2 • occupations 2



o advogado
lawyer



o contabilista
accountant

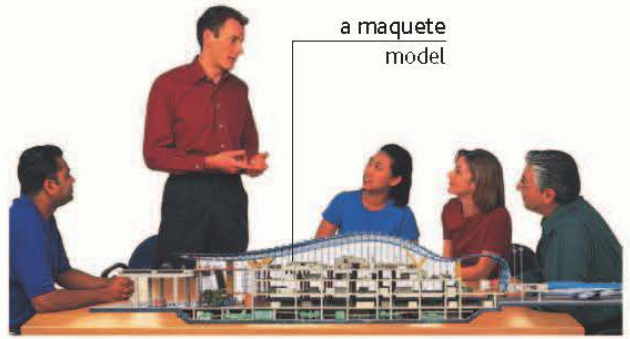

o arquitecto | architect



o cientista
scientist



o professor
teacher



o bibliotecário
librarian



a rececionista
receptionist



o carteiro
mail carrier



o motorista de autocarro
bus driver



o camionista
truck driver



o motorista de táxi
cab driver



o piloto
pilot



a hospedeira do ar
flight attendant



a agente de viagens
travel agent



o chefe de cozinha
chef



o músico
musician



o tutu
tutu

a bailarina
dancer



o actor
actor



a cantora
singer



a empregada
waitress



o empregado de bar
bartender



o desportista
athlete



o escultor
sculptor



a pintora
painter



o fotógrafo
photographer



o apresentador
news anchor



o jornalista
journalist

as notas
notes



a redactora
editor



a desenhadora
designer



a costureira
textile worker



o alfaiate
tailor





os transportes
transportation

as estradas • roads

a auto-estrada
highway

a cabina da portagem
toll booth

as marcas rodoviárias
road markings

a via de acesso
on-road

o sentido único
one-way

a linha divisória
divider

a saída
intersection

o semáforo
traffic light

o camião
truck

o separador central
median

a passagem subterrânea
underpass

a faixa da esquerda
inside lane

a faixa central
middle lane

a faixa de ultrapassagem
outside lane

a via de saída
exit ramp

o tráfego
traffic

o viaduto
overpass

a bermã
pavimentada
hard shoulder

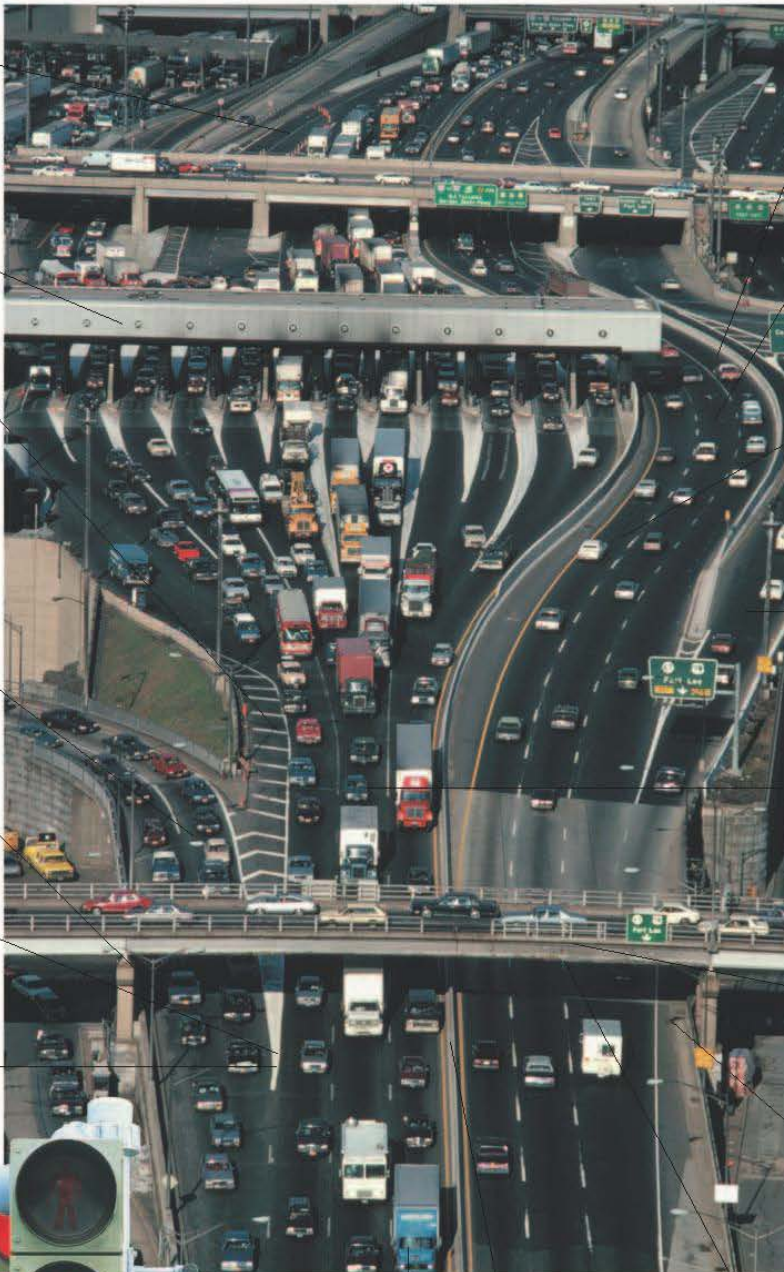



a passagem de peões
pedestrian crossing



o telefone de emergência
emergency phone



o estacionamento para deficientes
disabled parking



o engarrafamento de trânsito
traffic jam

o mapa
map



o parquímetro
parking meter



o polícia de trânsito
traffic police officer



vocabulário • vocabulary

a rotunda
traffic circle

estacionar (v)
park (v)

rebocar (v)
tow away (v)

o desvio
diversion

ultrapassar (v)
pass (v)

a faixa dupla
dual carriageway

as obras na estrada
roadwork

conduzir (v)
drive (v)

Esta é a estrada para...?
Is this the road to...?

a barreira de segurança
crash barrier

fazer marcha atrás (v)
back up (v)

Onde posso estacionar?
Where can I park?

os sinais de trânsito • road signs



sentido proibido
do not enter



o limite de velocidade
speed limit



o perigo
hazard



proibido parar
no stopping



proibido virar à direita
no right turn

o autocarro • bus

o lugar do
motorista
driver's seat

o corrimão
handrail

a porta
automática
automatic door

a roda da frente
front wheel

o porta-bagagens
luggage hold



a porta | door



a camioneta de passageiros | coach

os tipos de autocarros • types of buses



o autocarro de dois pisos
double-decker bus

o número da rota
route number

o motorista
driver



o eléctrico
tram



o autocarro eléctrico
trolley bus



o autocarro escolar | school bus



a roda traseira
rear wheel

a janela
window

o botão de paragem
stop button



o bilhete de autocarro
bus ticket



a campainha
bell



a estação de autocarros
bus station



a paragem de autocarros
bus stop

vocabulário • vocabulary

a tarifa
fare

o acesso para cadeiras de rodas
wheelchair access

o horário
timetable

o abrigo da paragem
bus shelter

Pára em...?
Do you stop at...?

Que autocarro vai para...?
Which bus goes to...?



o miniautocarro
minibus



o autocarro turístico | tourist bus



o autocarro de ligação | shuttle bus

o carro 1 • car 1

o exterior • exterior

o retrovisor lateral
side mirror

o pára-brisas
windshield

o espelho retrovisor
rearview mirror

o limpa-pára-brisas
windshield wiper

a porta
door

o capô
hood

a bagageira
trunk



o pisca-pisca
turn signal

o pára-choques
bumper

o farol dianteiro
headlight

a roda
wheel

o pneu
tire

a matrícula
license plate

a bagagem
luggage



o porta-bagagens
roofrack



a porta da bagageira
tailgate



o cinto de segurança
seat belt



a cadeira para crianças
child seat

os tipos • types



o compacto
small car



o carro de cinco portas
hatchback



a berlina
sedan



a carrinha
station wagon



o carro descapotável
convertible



o carro desportivo
sports car



o monovolume
minivan



o todo-o-terreno
four-wheel drive

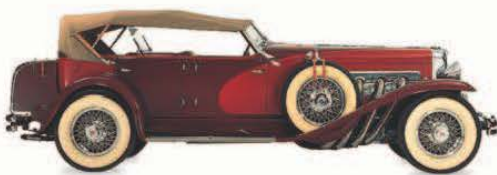

o carro de época
vintage



a limusina
limousine

o posto de abastecimento •
gas station



a bomba de
gasolina
gas pump

o preço
price

a zona de abastecimento
forecourt

a bomba de ar
air supply

vocabulário • vocabulary

o óleo
oil

com chumbo
leaded

a lavagem de
carros
car wash

a gasolina
gasoline

o gasóleo
diesel

o anticongelante
antifreeze

sem chumbo
unleaded

a oficina
garage

o líquido limpa-
pára-brisas
windshield wash

Encha o depósito, por favor.
Fill the tank, please.

o carro 2 • car 2

o interior • interior



vocabulário • vocabulary

de duas portas
two-door

de quatro portas
four-door

automático
automatic

o travão
brake

o acelerador
accelerator

de três portas
three-door

manual
manual

a ignição
ignition

a embraiagem
clutch

o ar condicionado
air-conditioning

Pode dizer-me como se vai para...?
Can you tell me the way to...?

Onde há um estacionamento?
Where is the car park?

Posso estacionar aqui?
Can I park here?

os controlos • controls

o volante
steering
wheel

a buzina
horn

o tablier
dashboard

as luzes de emergência
hazard lights

a navegação por satélite
satellite navigation



a direcção à esquerda | left-hand drive

o indicador de
temperatura
temperature gauge

o conta-rotações
tachometer

o velocímetro
speedometer

o indicador da gasolina
fuel gauge

o estéreo do carro
car stereo

o interruptor
das luzes
lights switch

os comandos de aquecimento
heater controls

o conta-
quilómetros
odometer

a manete das mudanças
gearshift

o airbag
air bag



a direcção à direita | right-hand drive

o carro 3 • car 3

a mecânica • mechanics

o depósito do limpapára-brisas
water fluid reservoir

a vareta medidora
dipstick

o filtro de ar
air filter

o depósito de óleo dos travões
brake fluid reservoir

a bateria
battery



a carroçaria
body

o depósito do líquido de refrigeração
coolant reservoir

a cabeça de cilindro
cylinder head

o tubo
pipe

o tecto de abrir
sunroof

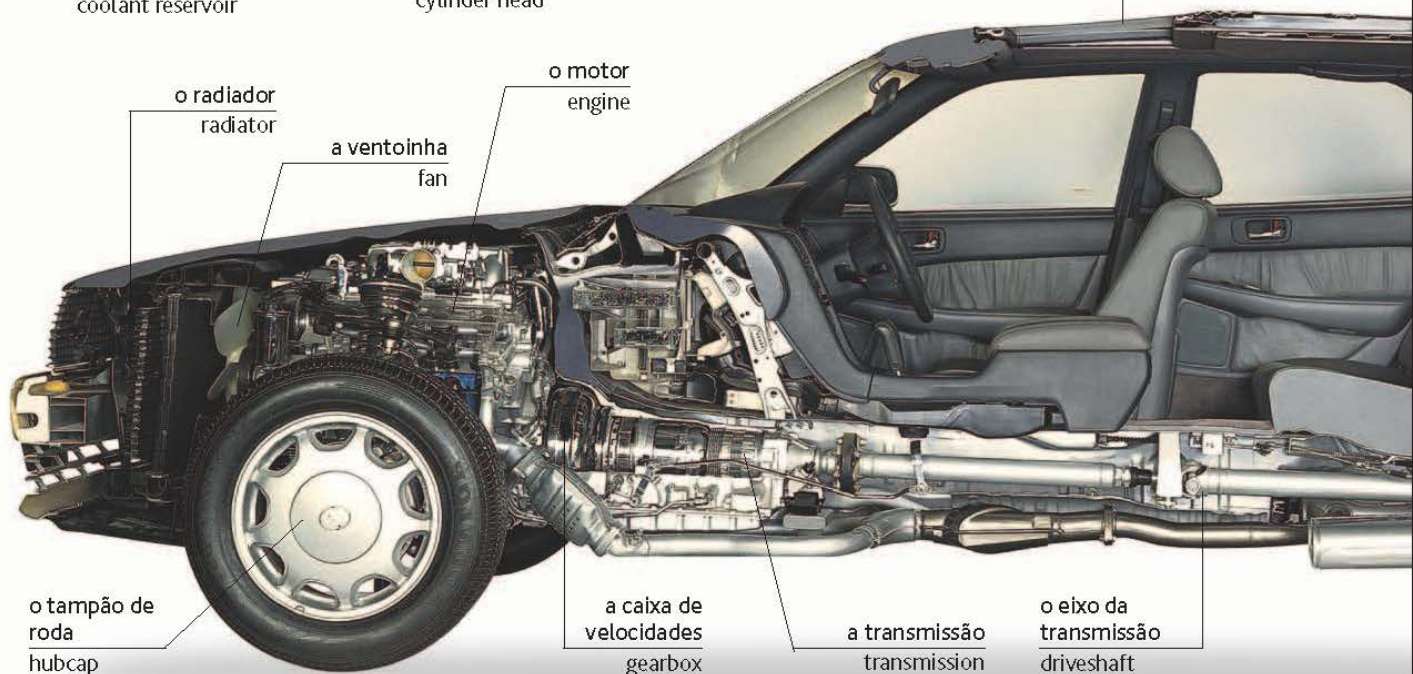

o radiador
radiator

a ventoinha
fan

o motor
engine

o tampão de roda
hubcap

a caixa de velocidades
gearbox

a transmissão
transmission

o eixo da transmissão
driveshaft

o furo • puncture

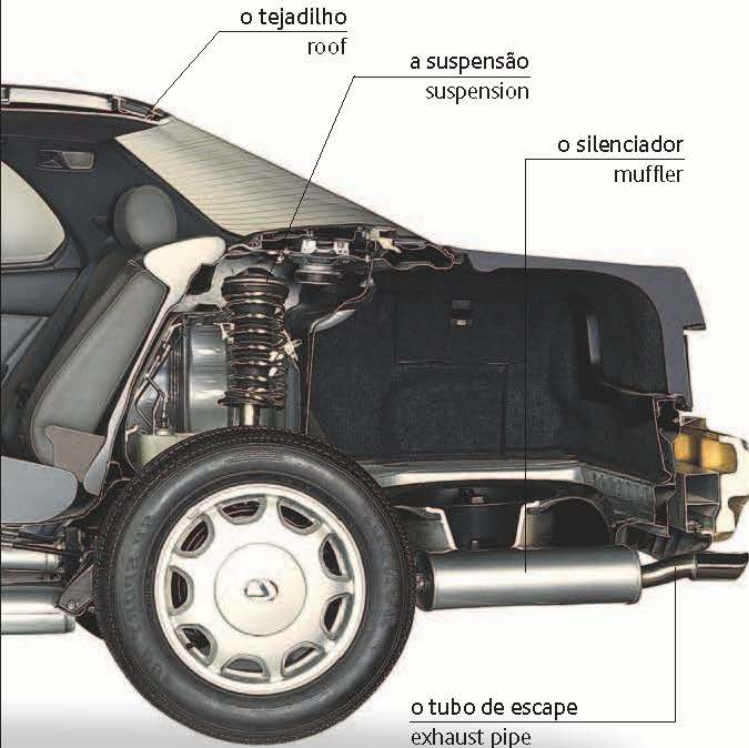

vocabulário • vocabulary

o acidente de carro
car accident

o turbocompressor
turbocharger

a avaria
breakdown

o distribuidor
distributor

o seguro
insurance

o chassis
chassis

o reboque
tow truck

o travão de mão
parking break

o mecânico
mechanic

o alternador
alternator

a pressão dos pneus
tire pressure

a correia de comando
cam belt

a caixa de fusíveis
fuse box

a vela de ignição
spark plug

a correia da ventoinha
fan belt

.....
O meu carro avariou.
I've had a breakdown.

o depósito da gasolina
gas tank

O meu carro não arranca.
My car won't start.

a afinação
timing

Faz reparações?
Do you do repairs?

O motor está a
sobreaquecer.
The engine is overheating

a motocicleta • motorbike

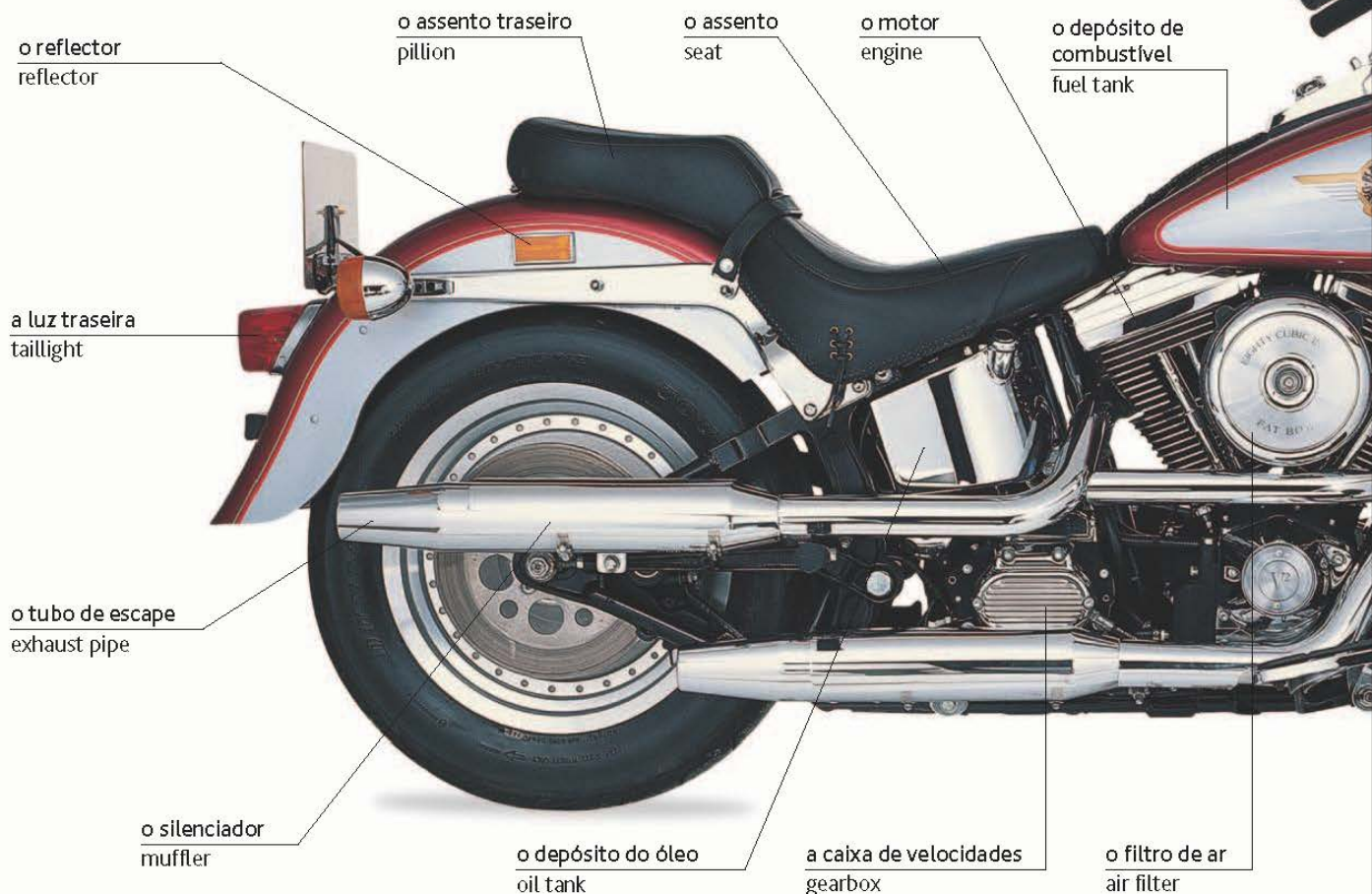
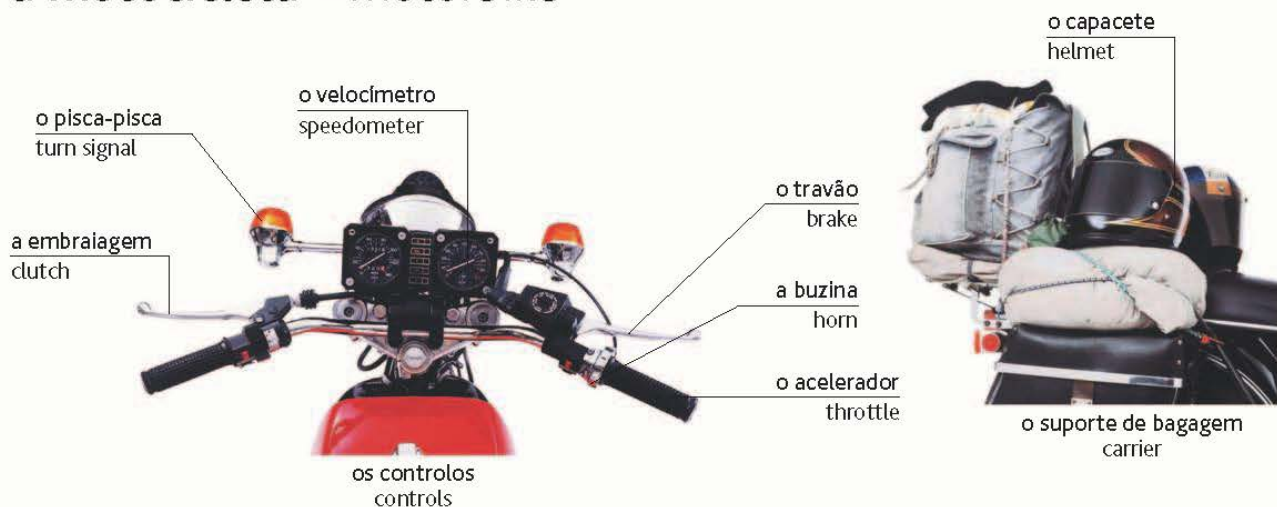



a viseira
visor

o fato de cabedal
leathers

a alça reflectora
reflector strap

a joelheira
knee pad

o vestuário | clothing

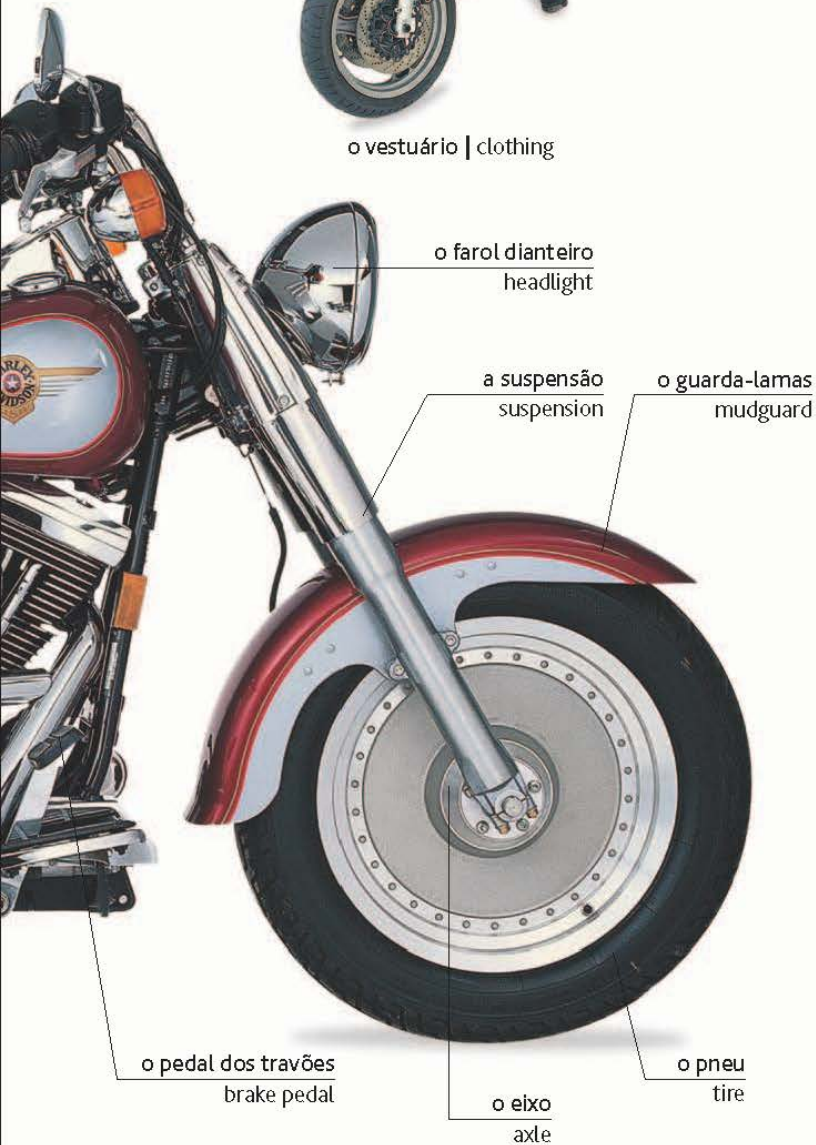

o farol dianteiro
headlight

a suspensão
suspension

o guarda-lamas
mudguard

o pedal dos travões
brake pedal

o eixo
axle

o pneu
tire

os tipos • types



a moto de corridas | racing bike

o pára-brisas
windshield



a moto de passeio | tourer



a moto de cross | dirt bike

o suporte
stand



a vespa | scooter

a bicicleta • bicycle



a tandem
tandem



a bicicleta de corridas
racing bike



a bicicleta de montanha
mountain bike



a bicicleta de passeio
touring bike



a bicicleta de estrada
road bike

o selim
saddle

o suporte do selim
seat post

o frasco da água
water bottle

o quadro
frame

o travão
brake

o eixo
hub

as mudanças
gears

a jante
rim

o pneu
tire

a corrente
chain

o pedal
pedal

o dente da roda
cog



a ciclovía | cycle lane



vocabulário • vocabulary

o farol headlight	a patilha de apoio kickstand	o calço de travão brake block	o cesto basket	o encaixe para o pé toe clip	travar (v) brake (v)
o farol traseiro rear light	o suporte para bicicletas bike rack	o cabo cable	o dínamo generator	a alça do pedal toe strap	andar de bicicleta (v) cycle (v)
o reflector reflector	as rodas de apoio training wheels	a roda dentada sprocket	o furo flat tire	pedalar (v) pedal (v)	mudar de velocidade (v) change gear (v)

o comboio • train

a carruagem
car

a
plataforma
platform

o carrinho
cart



o número da
plataforma
platform number

o passageiro diário
commuter

a estação de caminho-de-ferro | train station

os tipos de comboio • types of train



o comboio a vapor
steam train

a locomotiva
engine



o comboio a gasóleo | diesel train

a cabina do
maquinista
driver's cab

o carril
rail



o comboio eléctrico
electric train



o comboio de alta velocidade
high-speed train



o monocarril
monorail



o metro
subway



o tranvia
tram



o comboio de mercadorias
freight train



o vagão
compartment

o porta-bagagens
luggage rack

a janela
window

a linha
track

a porta
door

o lugar
seat

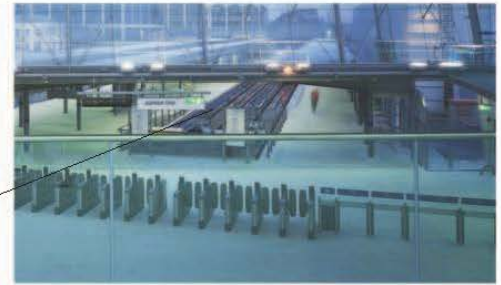

a barreira de acesso
ticket barrier

o sistema de comunicação
pública
public address system

o horário
timetable



o bilhete
ticket



o vagão-restaurante | dining car



o átrio da estação | concourse



o vagão-cama
sleeping compartment

vocabulário • vocabulary

a rede ferroviária
rail network

o diagrama do metro
subway map

a bilheteira
ticket office

o carril electrificado
third rail

o comboio intercity
intercity train

a demora
delay

o revisor
conductor

o sinal
signal

a hora de ponta
rush hour

a tarifa
fare

mudar (v)
change (v)

a alavanca de
emergência
emergency handle

o avião • aircraft

o avião de passageiros • airliner



a cabina • cabin

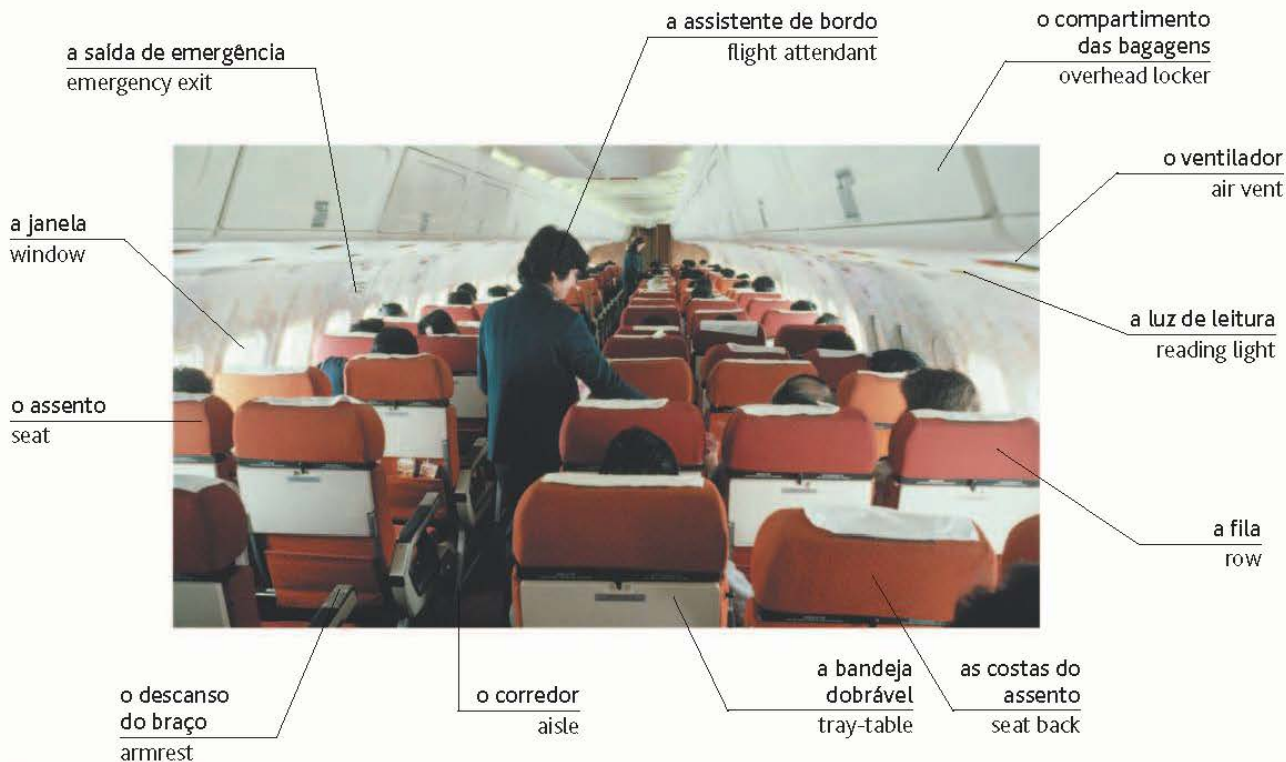



o balão de ar quente
hot-air balloon



o ultraligeiro
ultralight



o planador
glider



o biplano
biplane

a hélice
propeller



a avioneta
light aircraft



o hidroavião
sea plane



o jacto privado
private jet



o avião supersónico
supersonic jet

a lâmina do rotor
rotor blade



o helicóptero
helicopter



o bombardeiro
bomber



o míssil
missile

o caça
fighter plane

vocabulário • vocabulary

o piloto
pilot

descolar (v)
take off (v)

aterrar (v)
land (v)

a classe económica
economy class

a bagagem de mão
luggage

o co-piloto
copilot

voar (v)
fly (v)

a altitude
altitude

a classe executiva
business class

o cinto de segurança
seat belt

o aeroporto • airport



o avião de linha | airliner

a área de tráfego
apron

o reboque de
bagagem
baggage trailer

o terminal
terminal

o veículo de serviço
service vehicle

a ponte de embarque
walkway

vocabulário • vocabulary

a pista
runway

o número do voo
flight number

o tapete das bagagens
carousel

as férias
holiday

o voo internacional
international flight

a imigração
immigration

a segurança
security

fazer o check-in (v)
check in (v)

o voo doméstico
domestic flight

a alfândega
customs

a máquina de raios X
X-ray machine

a torre de controlo
control tower

a ligação
connection

o excesso de bagagem
excess baggage

a brochura
holiday brochure

reservar uma passagem (v)
book a flight (v)

a bagagem de mão
carry-on luggage

a bagagem
luggage

o carrinho
cart



o balcão de check-in
check-in desk



o passaporte | passport

o visto
visa



o controlo de passaportes
passport control

o cartão de embarque
boarding pass



o bilhete
ticket



a sala de embarque
departure lounge

o número da porta de embarque
gate number

as partidas
departures



o ecrã de informação
information screen

o destino
destination

as chegadas
arrivals



a loja franca
duty-free shop



a recolha de bagagens
baggage claim



a paragem de táxis
cab stand



o aluguer de carros
car rental

o navio • ship

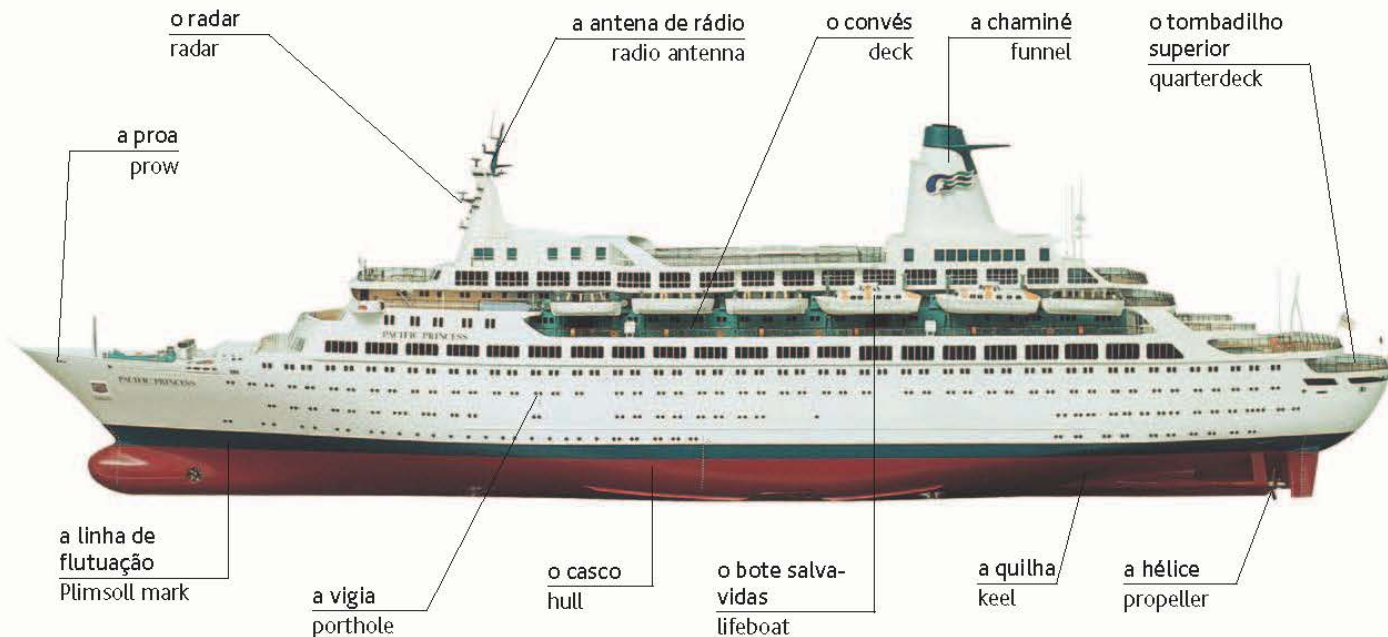

o transatlântico | ocean liner

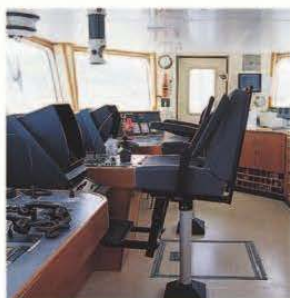

a ponte de comando
bridge



a casa das máquinas
engine room



o camarote
cabin

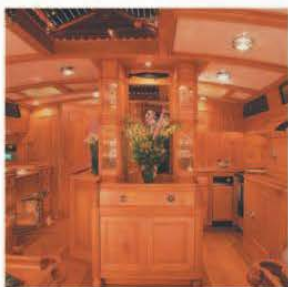

a cozinha
galley

vocabulário • vocabulary

a doca
dock

o porto
port

o portaló
gangway

a âncora
anchor

o cabeço
bollard

o cabrestante
windlass

o capitão
captain

a lancha rápida
speedboat

o barco a remos
rowboat

a canoa
canoe

outras embarcações • other ships



o ferry
ferry



o motor fora-de-borda
outboard motor



o hidrofoil
hydrofoil



o iate
yacht



o catamarã
catamaran



o rebocador
tugboat



o hovercraft
hovercraft



o navio porta-contentores
container ship



o barco à vela
sailboat



o navio de carga
freighter



o petroleiro
oil tanker



o porta-aviões
aircraft carrier



o navio de guerra
battleship



a torre de comando
conning tower

o submarino
submarine

o porto • port

o armazém
warehouse

a grua
crane

a empilhadeira
forklift

a estrada de acesso
access road

a alfândega
customs house



a doca
dock

o contentor
container

o cais
quay

a carga
cargo



o porto de contentores | container port

o terminal de ferries
ferry terminal

o ferry
ferry

a bilheteira
ticket office

o passageiro
passenger

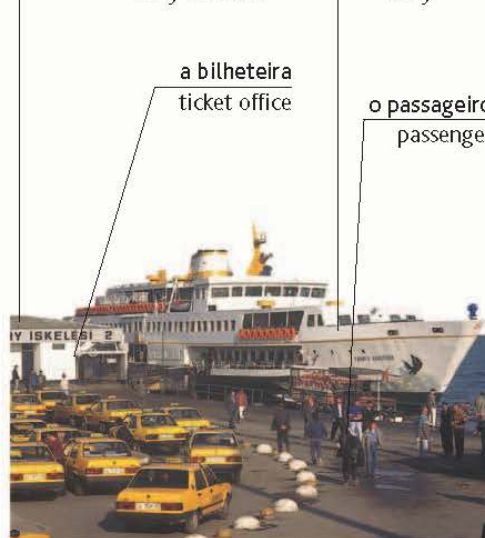

o porto de passageiros | passenger port

a rede
net

o barco de pesca
fishing boat

a ancoragem
mooring



o porto de pesca | fishing port



a marina | marina



o porto | harbor



o embarcadouro | pier



o pontão
jetty



o estaleiro
shipyard

a lâmpada
lamp



o farol
lighthouse



a bóia
buoy

vocabulário • vocabulary

o guarda-costeiro
coastguard

a doca seca
dry dock

embarcar (v)
board (v)

o capitão do porto
harbor master

amarrar (v)
moor (v)

desembarcar (v)
disembark (v)

fundear (v)
drop anchor (v)

atracar (v)
dock (v)

zarpar (v)
set sail (v)



o futebol americano • football

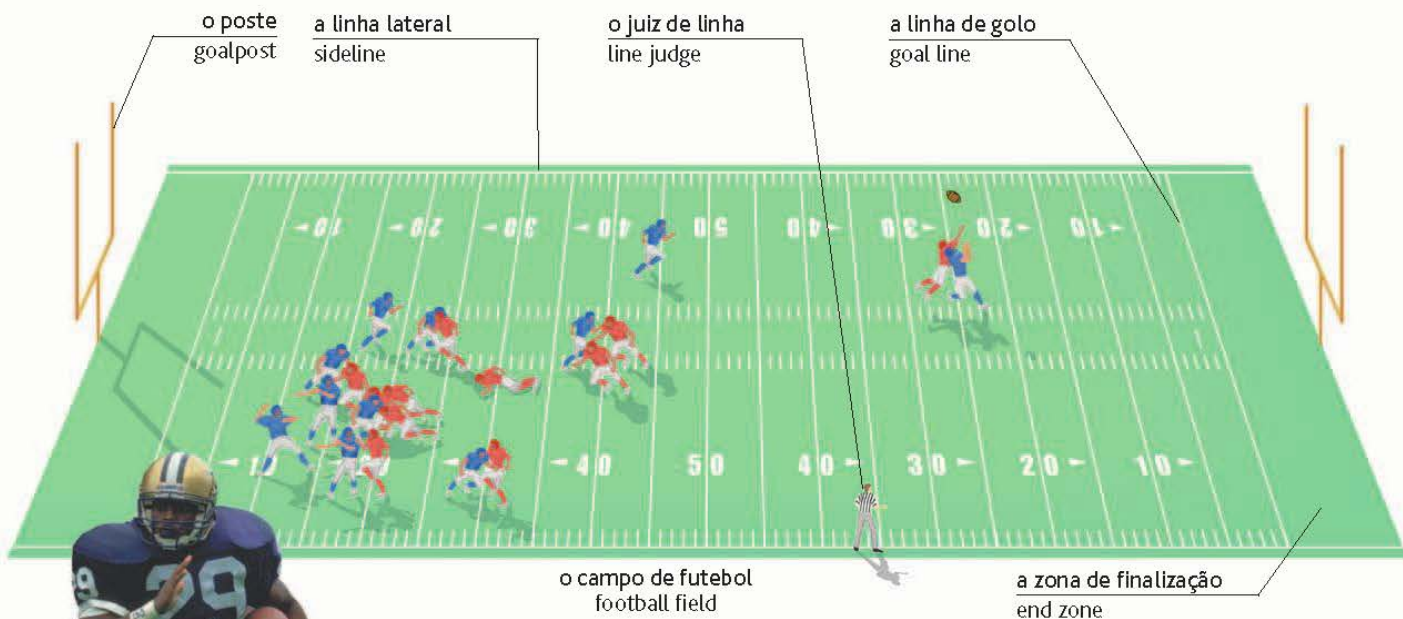

o jogador football player

a bola de futebol football

as caneleiras pads

o capacete helmet

a bota boot



placar (v)
tackle (v)



passar (v)
pass (v)



apanhar (v)
catch (v)

vocabulário • vocabulary

o tempo morto
time out

a equipa
team

a defesa
defense

a chefe de claque
cheerleader

Como vai o jogo?
What is the score?

o mau passe da bola
fumble

o ataque
attack

a pontuação
score

o ensaio
touchdown

Quem está a ganhar?
Who is winning?

o rãguebi • rugby

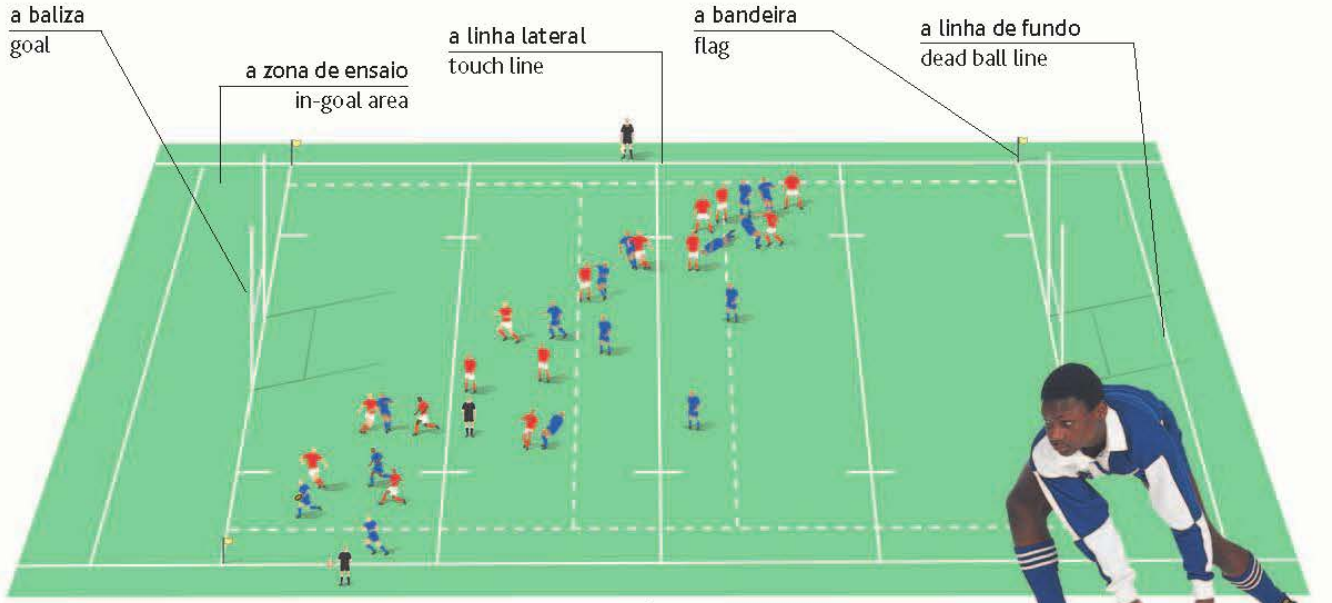

o campo de rãguebi | rugby field



atirar (v)
throw (v)

a bola ball



chutar (v)
kick (v)

a roupa da equipa
rugby uniform



passar (v)
pass (v)



placar (v)
tackle (v)



o ensaio
try



o ruck | ruck

o jogador
player



a mêlée | scrum

o futebol • soccer

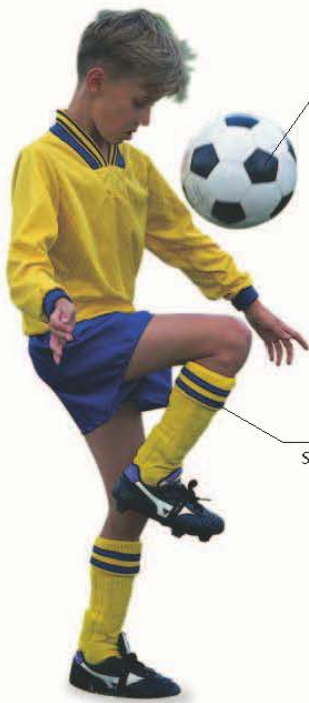

o futebolista
soccer player

a bola
soccer ball

o guarda-redes
goalkeeper

a roupa da
equipa
soccer uniform

o avançado
forward

o árbitro
referee

o círculo central
center circle

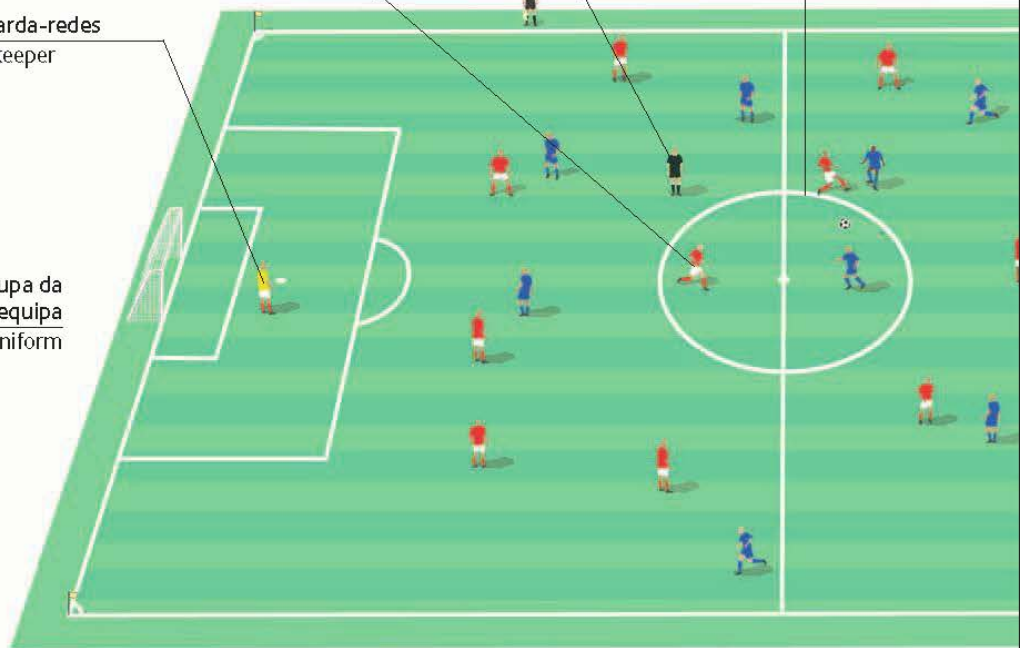

o poste da
baliza
goalpost

a rede
net

a barra
transversal
crossbar



a baliza | goal

o campo de futebol
soccer field



driblar (v) | dribble (v)



cabecear (v)
head (v)



a barreira
wall

o pontapé livre | free kick

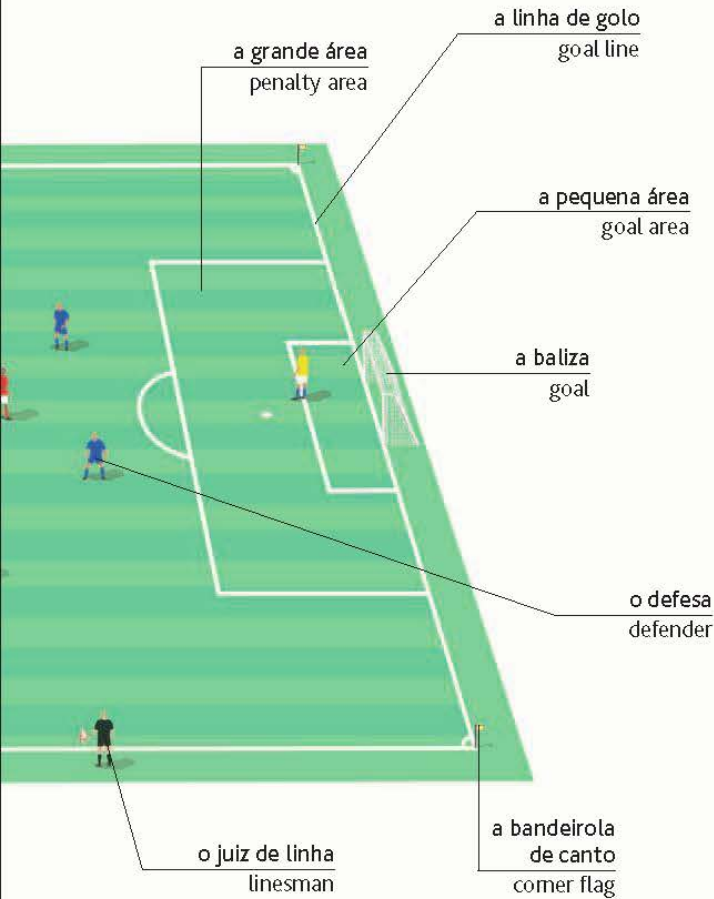

o lançamento lateral
throw-in



chutar (v) | kick (v)

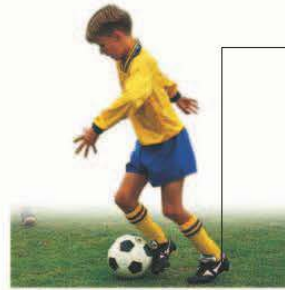

passar (v)
pass (v)

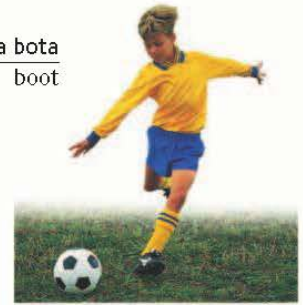

a bota
boot

atirar (v)
shoot (v)



fazer uma defesa (v)
save (v)



fazer uma entrada (v)
tackle (v)

vocabulário • vocabulary

o estádio
stadium

a falta
foul

o cartão amarelo
yellow card

a liga
league

o prolongamento
extra time

marcar um golo (v)
score a goal (v)

o canto
corner

o fora de jogo
off-side

o empate
draw

o suplente
substitute

a grande penalidade
penalty

o cartão vermelho
red card

a expulsão
send off

o intervalo
half time

a substituição
substitution

o hóquei • hockey

o hóquei no gelo • ice hockey

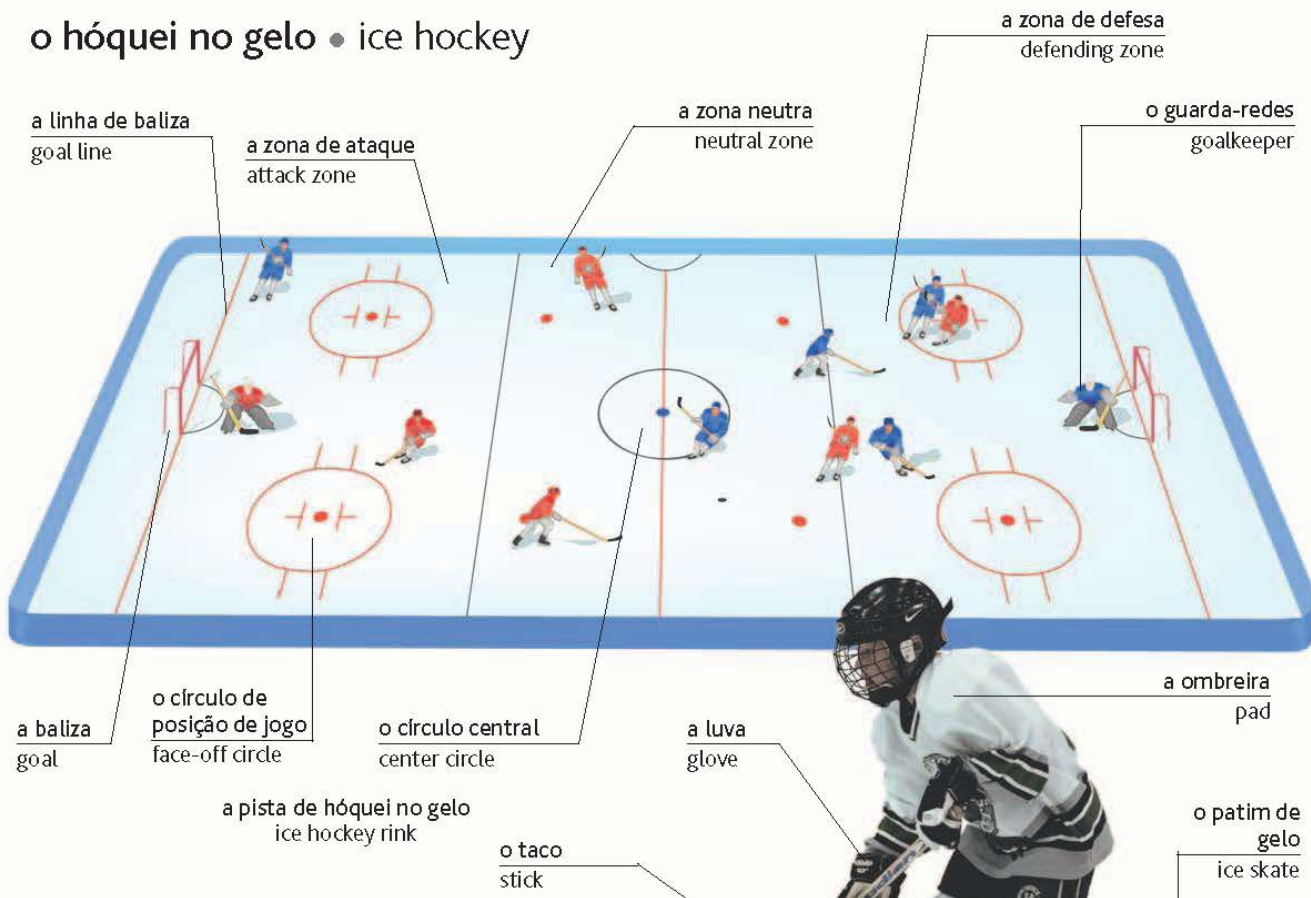

o hóquei de campo • field hockey

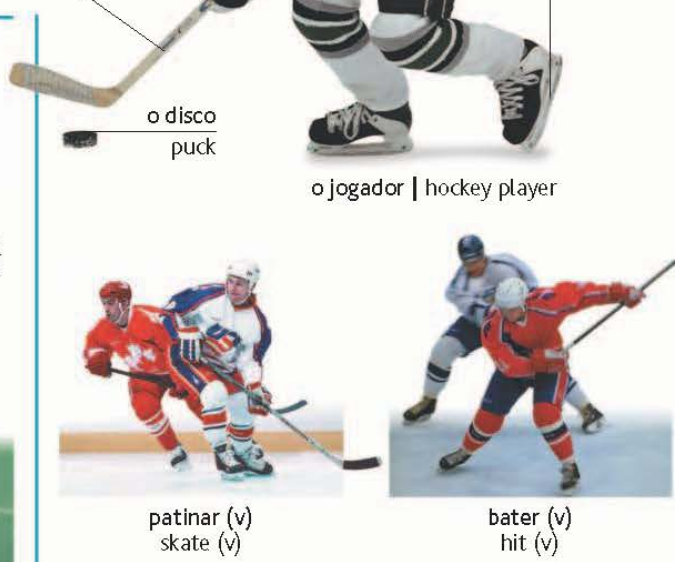
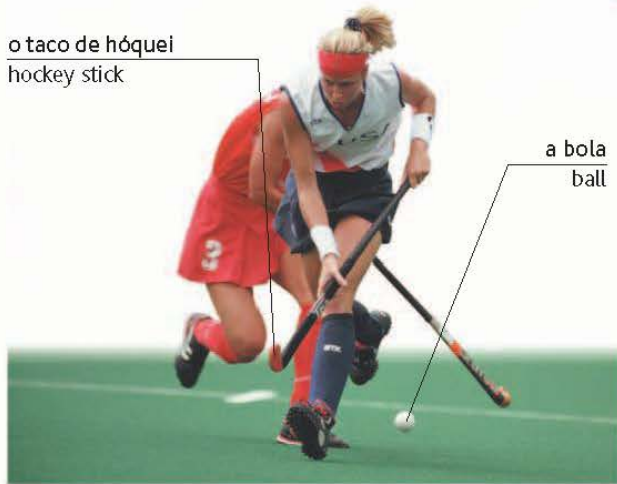

o críquete • cricket

o wicket
wicket

o campo de críquete
pitch

o protetor da cara
face mask

o bateador
batsman

a linha de jogo
crease

a linha de campo
boundary line

o lançador
bowler

a estaca vertical
stump

a pá
bat

a caneleira
leg pad

o jogador
cricketer

lançar (v)
bowl (v)

bater (v)
bat (v)

a bola de críquete
cricket ball

defender (v)
field (v)

o guarda do wicket
wicket-keeper

vocabulário • vocabulary

fora out	o marcador scoreboard	o árbitro umpire
-------------	--------------------------	---------------------

o basquetebol • basketball

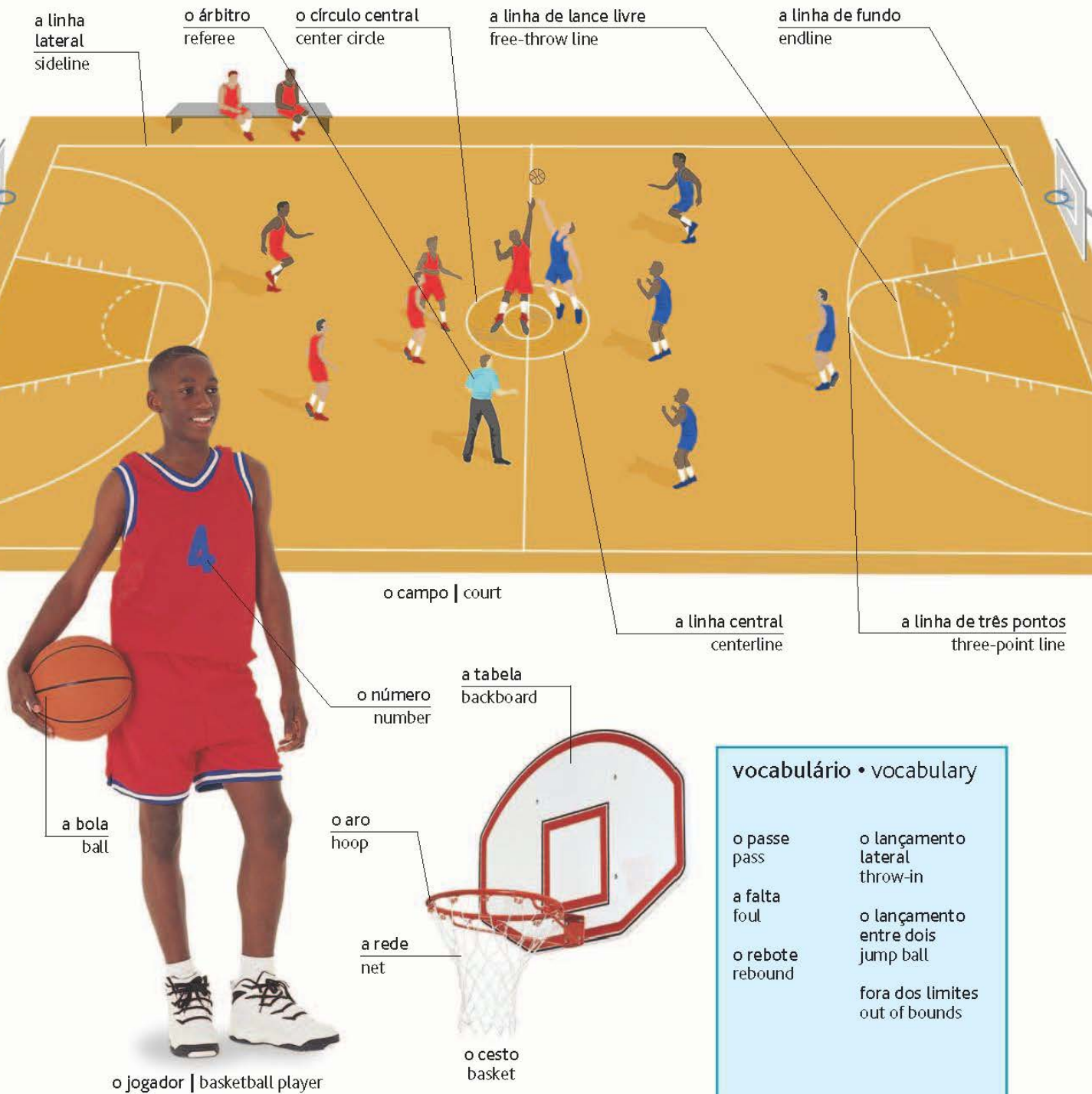

vocabulário • vocabulary

o passe
pass

a falta
foul

o rebote
rebound

o lançamento
lateral
throw-in

o lançamento
entre dois
jump ball

fora dos limites
out of bounds

as acções • actions



lançar (v)
throw (v)



apanhar (v)
catch (v)



arremessar (v)
shoot (v)



saltar (v)
jump (v)



encestar (v)
dunk (v)



marcar (v)
mark (v)



bloquear (v)
block (v)



bater (v)
bounce (v)

o voleibol • volleyball

bloquear (v)
block (v)

a rede
net

defender
baixo (v)
dig (v)

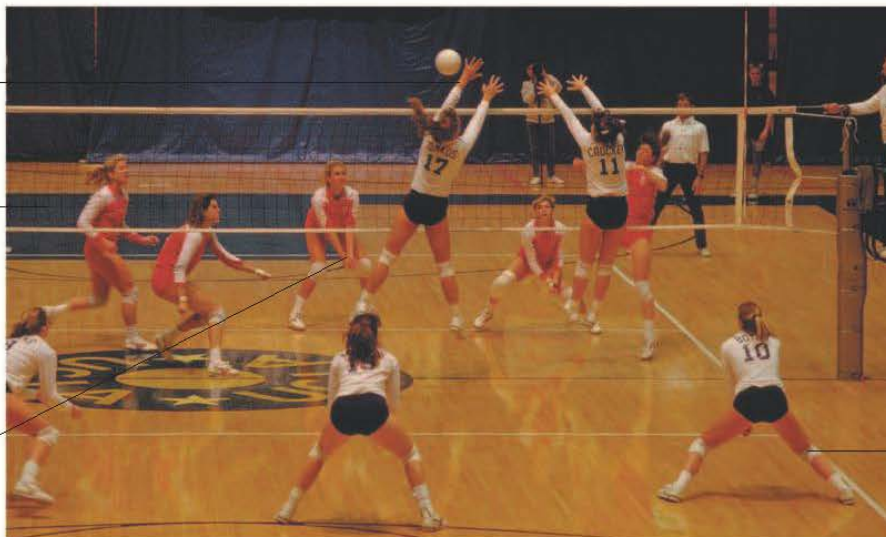

o árbitro
referee

a joelheira
knee support

o campo | court

o basebol • baseball

o campo • field

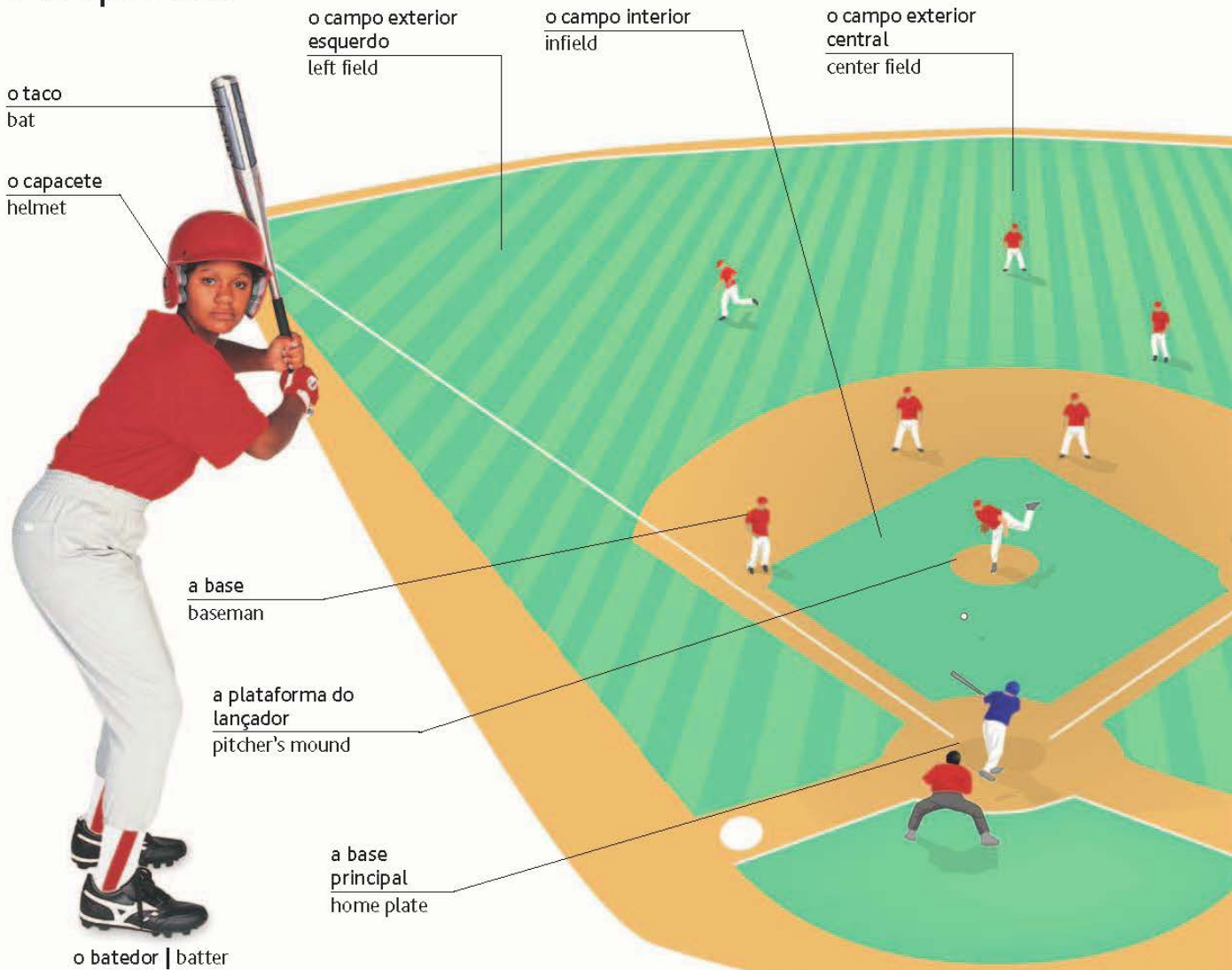

vocabulário • vocabulary

o turno
inning

a salvo
safe

a falta
foul ball

a corrida
run

fora
out

o golpe
strike



a luva | glove

a bola
ball



a máscara | mask

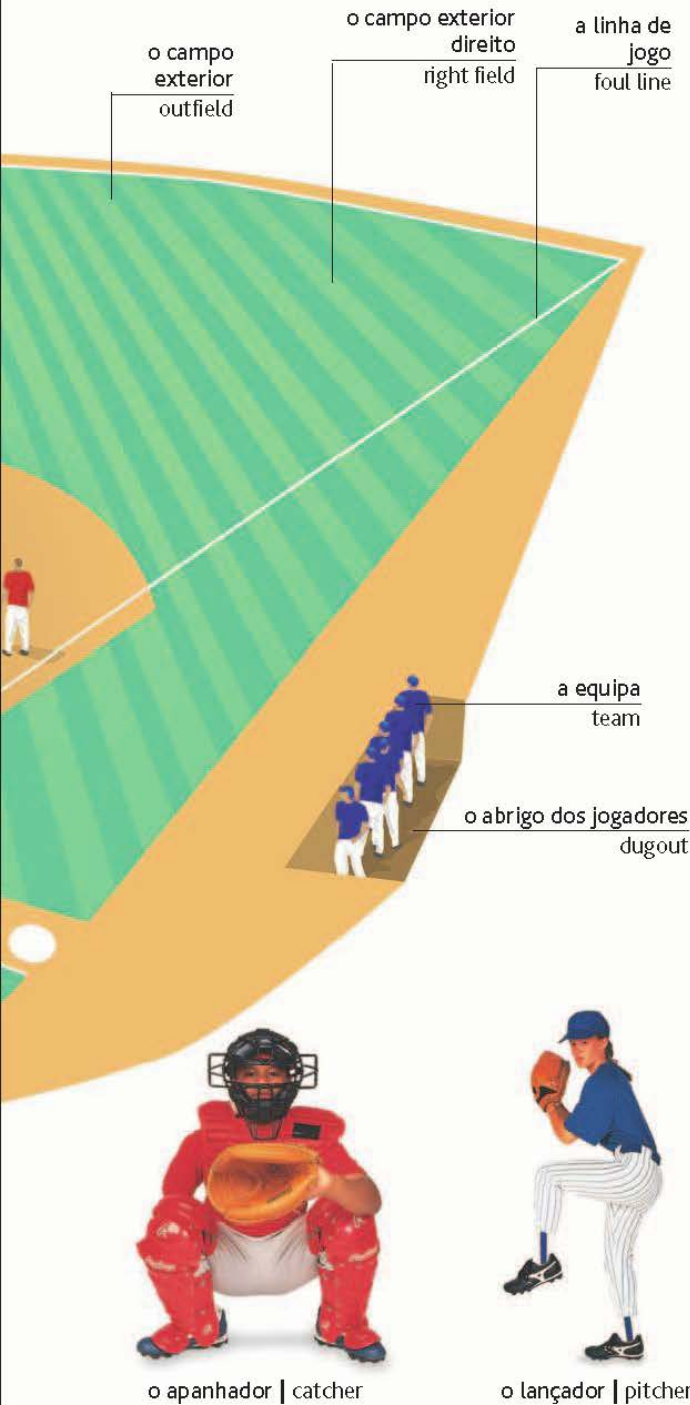

as acções • actions



lançar (v) | throw (v)

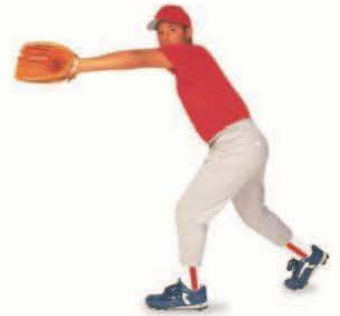

apanhar (v) | catch (v)



correr (v)
run (v)



defender (v) | field (v)

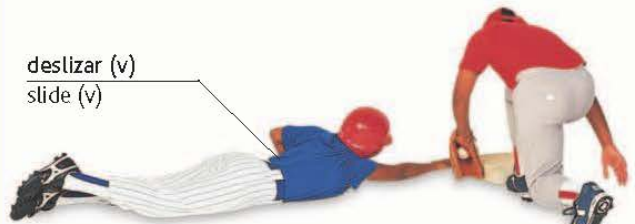

deslizar (v)
slide (v)

perseguir (v)
tag (v)

lançar (v)
pitch (v)

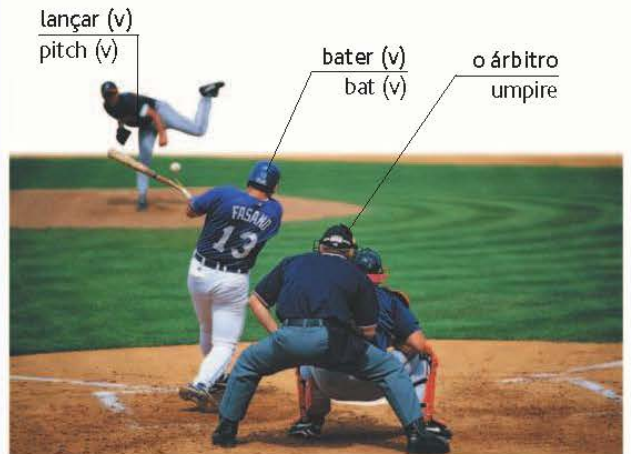

bater (v)
bat (v)

o árbitro
umpire

jogar (v) | play (v)

o ténis • tennis

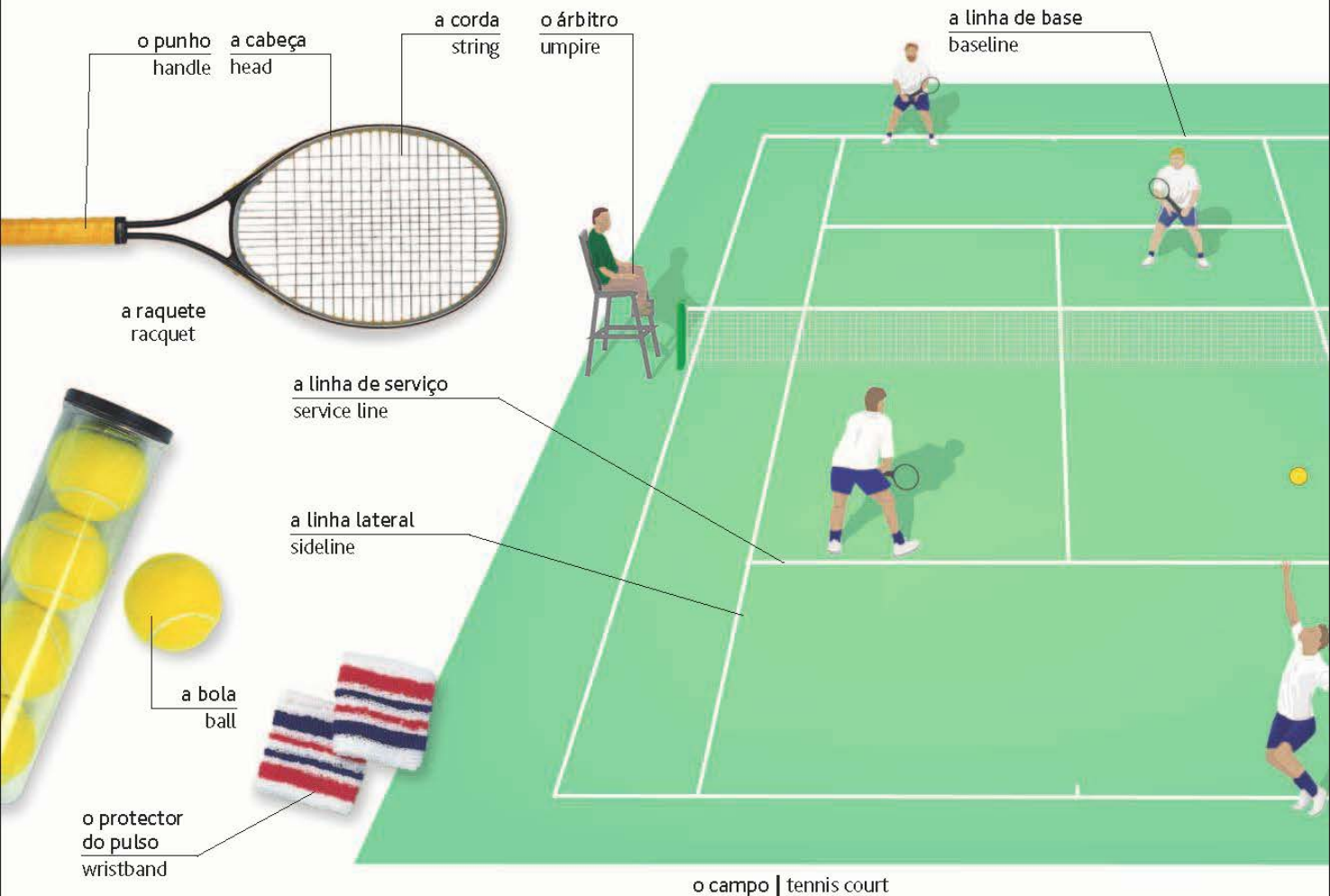

vocabulário • vocabulary

os singulares
singles

o set
set

o empate
deuce

a falta
fault

o golpe com efeito
slice

o efeito
spin

as duplas
doubles

a partida
match

a vantagem
advantage

o ás
ace

a troca de bolas
rally

o juiz de linha
linesman

o jogo
game

o tiebreak
tiebreak

zero
love

o golpe curto
dropshot

rede!
let!

o campeonato
championship

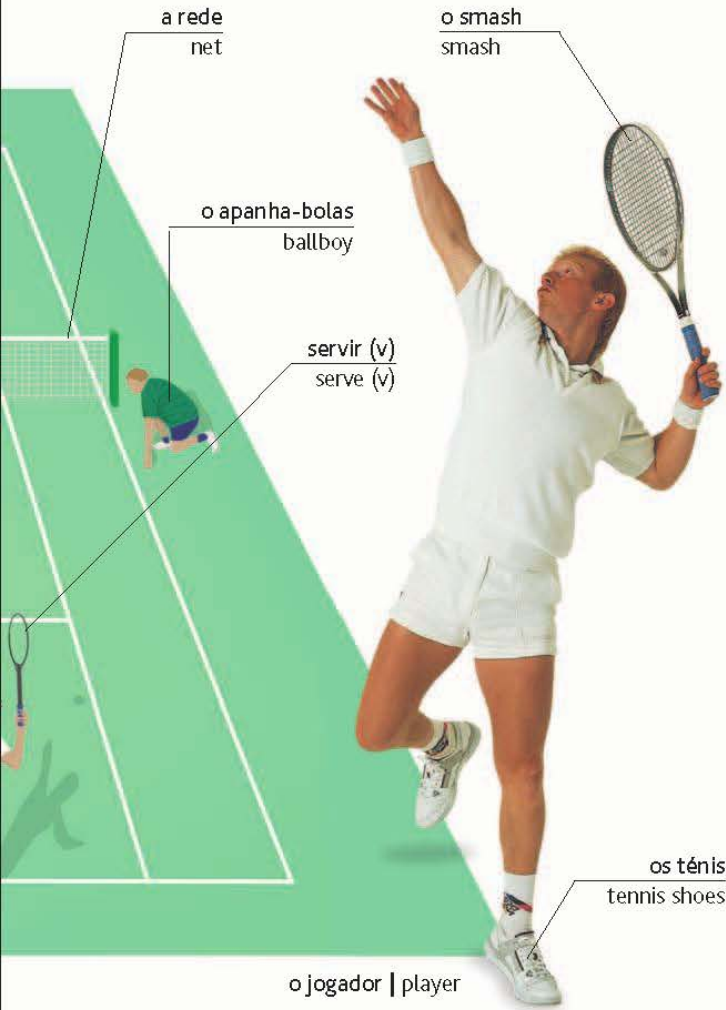

os golpes • strokes



o serviço
serve

o voleio
volley



a devolução
return



o lob
lob



o golpe de direita
forehand



o golpe de esquerda
backhand

os jogos de raquete • racquet games



o badminton
badminton

o volante
shuttlecock



o ténis de mesa
table tennis

a raquete
bat



o squash
squash



o raquetebol
racquetball

o golfe • golf

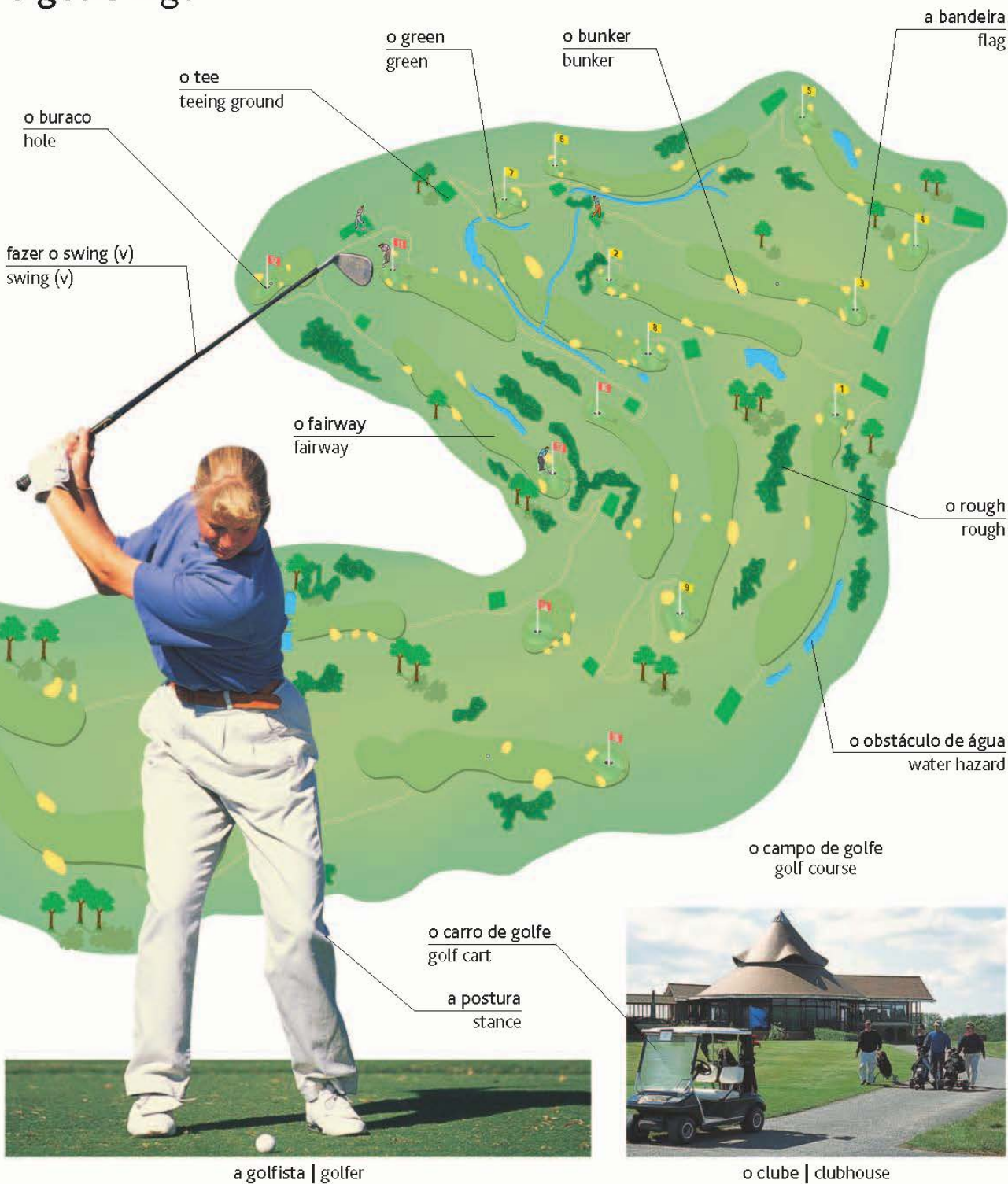

o equipamento • equipment



os tacos de golfe • golf clubs



as acções • actions



vocabulário • vocabulary

o par
paracima do par
over paro handicap
handicapo caddie
caddyo backswing
backswingo golpe
strokeabaixo do par
under paro buraco com
uma tacada
hole in oneo torneio
tournamentos espectadores
spectatorso swing de prática
practice swinga linha de jogo
line of play

o atletismo • track and field

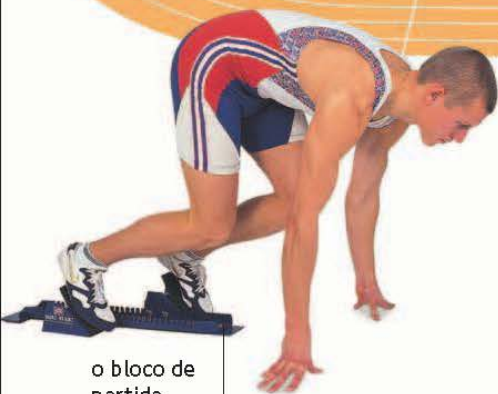

o bloco de partida starting blocks

o corredor de velocidade sprinter



o lançamento do disco discus



o lançamento do peso shotput



o lançamento do dardo javelin

o estádio field

a atleta athlete

vocabulário • vocabulary

a corrida race

o recorde record

o photo finish photo finish

o salto à vara pole vault

o tempo time

bater recorde (v) break a record (v)

a maratona marathon

a melhor marca pessoal personal best



o cronómetro stopwatch

o bastão
baton



a corrida de estafetas
relay race

a barra
crossbar



o salto em altura
high jump



o salto em comprimento
long jump



a corrida de barreiras
hurdles

a ginástica • gymnastics

o trampolim
springboard



o salto mortal
somersault



a ginasta
gymnast



a trave | beam

o cavalo
horse



o salto de cavalo
vault



o tapete
praticável
mat

os exercícios de solo
floor exercises

a fita
ribbon



a pirueta
tumble



ginástica rítmica
rhythmic gymnastics

vocabulário • vocabulary

a barra horizontal
horizontal bar

o cavalo com arções
pommel horse

as argolas
rings

as medalhas
medals

de prata
silver

as paralelas
parallel bars

as paralelas
assimétricas
asymmetric bars

o pódio
podium

de ouro
gold

de bronze
bronze

os desportos de combate • combat sports

o adversário
opponent

o protector
guard

a luva
glove

a faixa
belt



o karaté | karate

o tae kwon do | tae-kwon-do

a máscara
mask



o aikido | aikido



a espada
sword

o kendo | kendo



o judo | judo



o kung fu | kung fu



o kickboxing | kickboxing

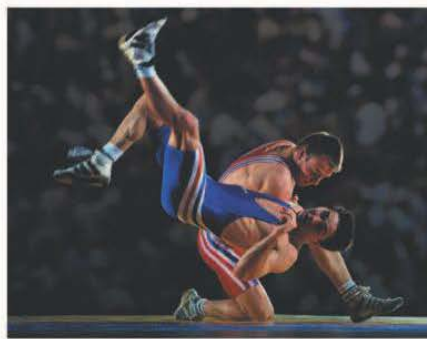

a luta livre | wrestling



o jogo de boxe | boxing

as acções • actions



a queda | fall



o agarrar | hold



a projecção | throw



a imobilização | pin



o pontapé | kick



o soco | punch



o ataque | strike

o ataque de mão aberta
chop

o pontapé em salto | jump



o bloqueio | block

vocabulário • vocabulary

o ringue de boxe
boxing ringo assalto
roundo punho
fista faixa preta
black belta capoeira
capoeiraas luvas de boxe
boxing gloveso combate
bouto nocaute
knock outa defesa pessoal
self defensea luta sumo
sumo wrestlingo protector dos dentes
mouth guardo treinamento
sparringo saco de boxe
punch bagas artes marciais
martial artso tai-chi
tai-chi

a natação • swimming

o equipamento • equipment



a braçadeira
armband



os óculos de natação | goggles

a pinça para o
nariz
nose clip



o flutuador | float



o fato de banho
swimsuit

a pista
lane

a água
water

o bloco de
partida
starting block



a piscina | swimming pool

a touca de
natação
cap

o calção de
banho
trunks

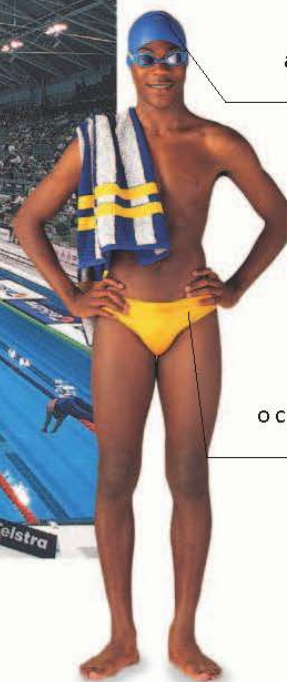

o nadador | swimmer

o trampolim
springboard

o mergulhador
diver



mergulhar (v) | dive (v)



nadar (v) | swim (v)



a viragem | turn

os estilos • styles



crawl | front crawl



bruços | breaststroke

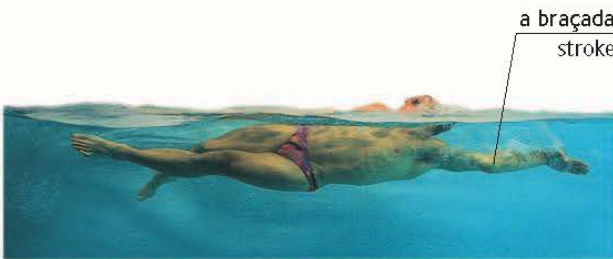

costas | backstroke



mariposa | butterfly

o mergulho submarino • scuba diving



vocabulário • vocabulary

o mergulho
divefazer água (v)
tread water (v)os cacifos
lockerso pólo aquático
water poloa parte pouco profunda
shallow enda câibra
crampo mergulho alto
high diveo mergulho de
partida
racing diveo salva-vidas
lifeguarda parte
profunda
deep enda natação sincronizada
synchronized swimmingafogar-se (v)
drown (v)

a vela • sailing



a bússola
compass



a âncora
anchor

o cunho
cleat



navegar (v) | navigate (v)

a bujarrona
headsail

a coberta
side deck

a proa
bow

a cana do
leme
tiller

o casco
hull



o mastro
mast

o cordame
rigging

a vela grande
mainsail

a carregadeira
boom

a popa
stern

o iate | yacht

a segurança • safety

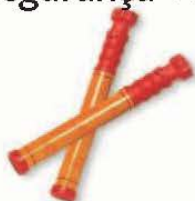

o sinal luminoso
flare



a bóia de salvação
lifebuoy



o colete de salvação
life jacket



a balsa de salvamento
life raft

os desportos aquáticos • watersports

o remador
rowero remo
oar

remar (v) | row (v)

o calaque
kayako remo
paddlea canoagem
canoeinga vela
sailo windsurfista
windsurfero flutuador
board

o windsurf | windsurfing

a prancha de
surf
surfboardo surf
surfingo esqui
skio esqui aquático
waterskiingas lanchas rápidas
speed boatingo fixador de pé
footstrapo rafting
raftingo jet ski
jet skiing

vocabulário • vocabulary

o esquiador aquático
waterskiera tripulação
crewo vento
winda rebentação
surfa escota
sheeto patilhão
centerboardo surfista
surfervirar (v)
tack (v)a onda
waveos rápidos
rapidso leme
ruddervirar (v)
capsize (v)

a equitação • horse riding

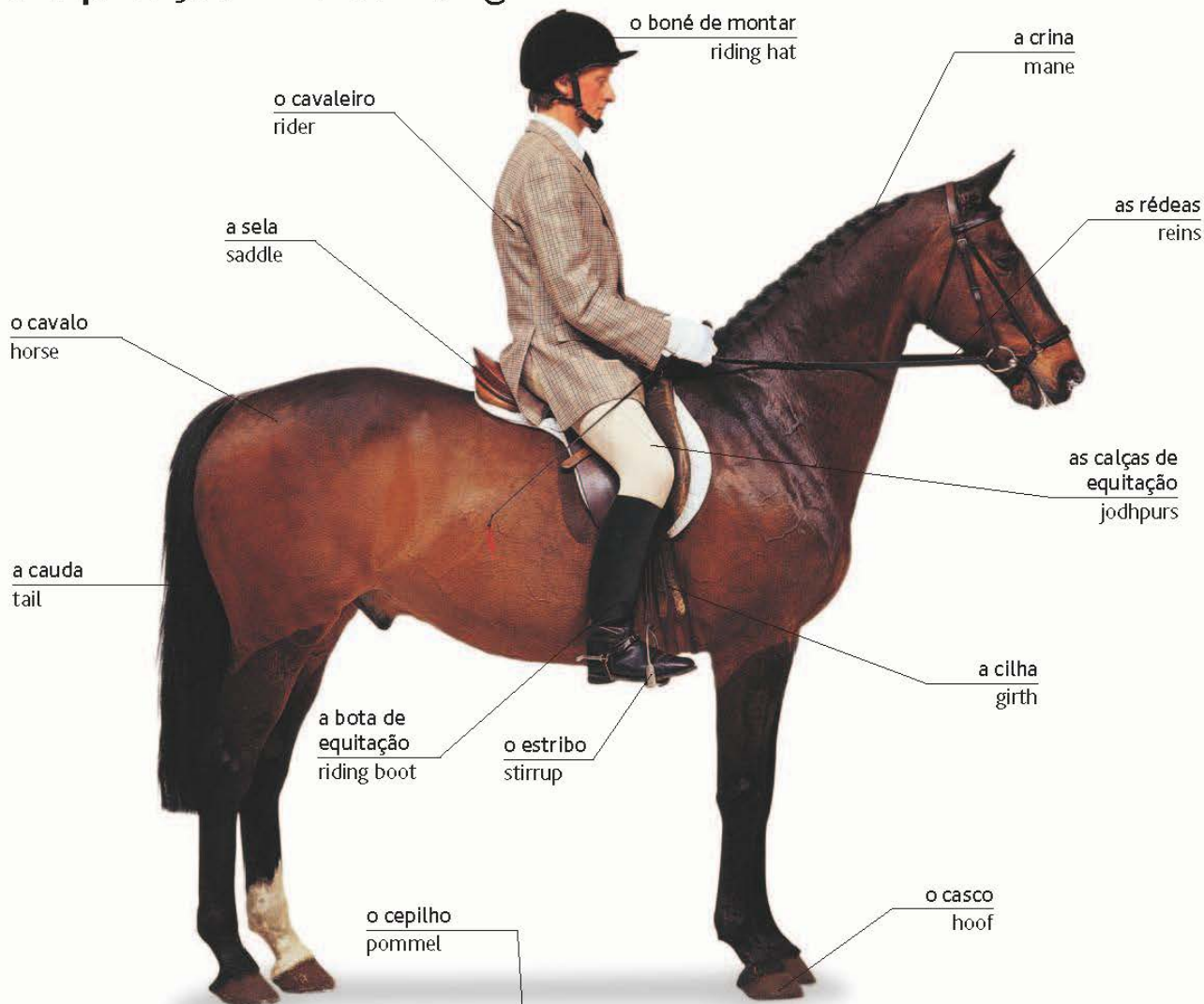

a ferradura
horseshoe



o assento
seat

a sela de senhora
side-saddle

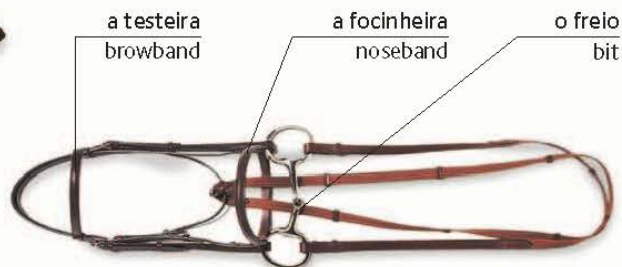

a testeira
browband

a focinheira
noseband

o freio
bit

a brida | bridle



o pingalim | riding crop

as modalidades • events

o cavalo de corridas
racehorsea corrida de cavalos
horse racea barreira
fencea corrida de obstáculos
steeplechasea corrida de trote
harness raceo rodeio
rodeoo concurso hípico de saltos
showjumpinga corrida de carruagens
carriage race

o passeio a cavalo | trekking



a dressage | dressage



o pólo | polo

vocabulário • vocabulary

o passo
walko galope leve
cantero salto
jumpo cabresto
haltero cercado
paddocka corrida plana
flat raceo trote
troto galope
gallopo moço de
estrearria
groomo estábulo
stablea arena
arenao hipódromo
racecourse

a pesca • fishing



o peso | weight

a bábula
barb

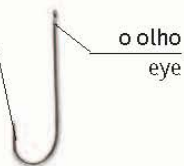

o olho
eye

o anzol
fishhook



a isca | bait



o flutuador
float



o isco artificial
lure



a mosca
fly



a tarrafa
landing net



a caixa de material
tackle box



a rede para o peixe capturado
keep net

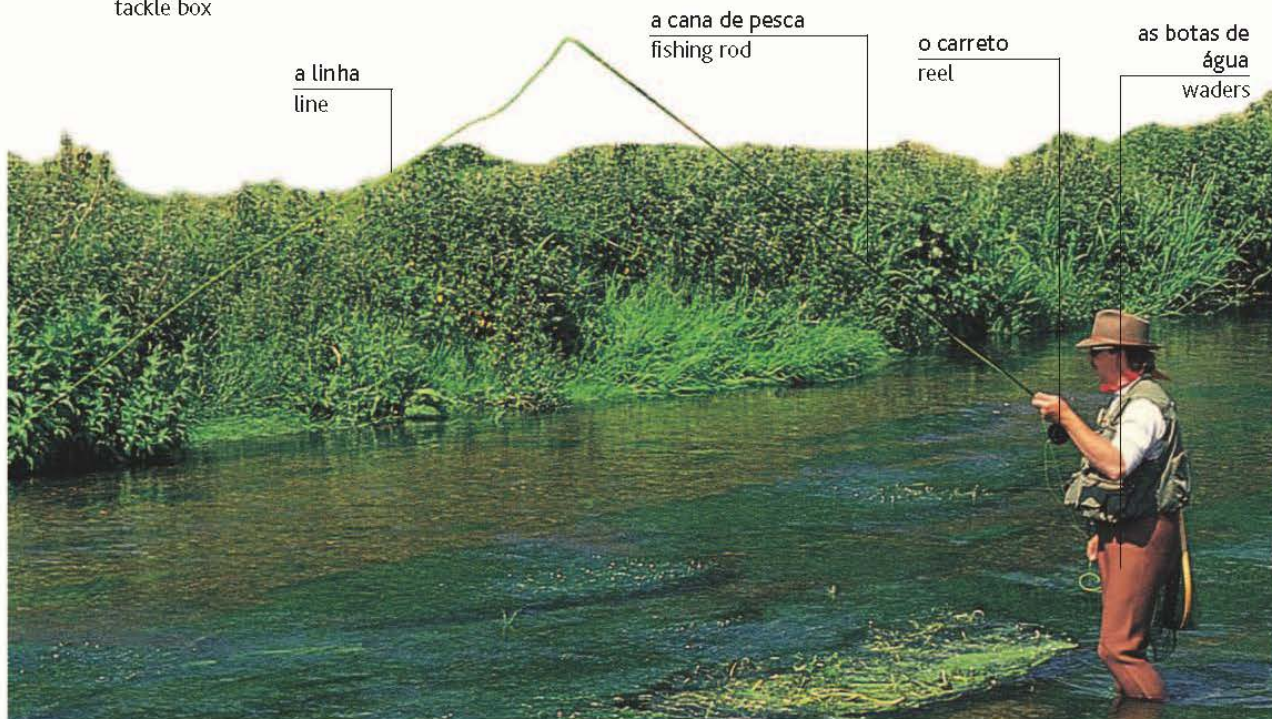

a linha
line

a cana de pesca
fishing rod

o carreto
reel

as botas de
água
waders

o pescador à linha | angler

os tipos de pesca • types of fishing



a pesca em água doce
freshwater fishing



a pesca com mosca
fly fishing



a pesca surfcasting
surfcasting



a pesca desportiva
sport fishing



a pesca de alto mar
deep sea fishing

as acções • activities



lançar (v)
cast (v)



apanhar (v)
catch (v)



recolher (v)
reel in (v)

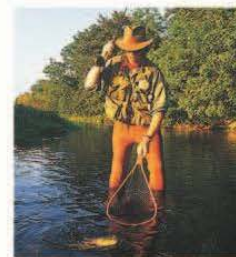

apanhar com a rede (v)
net (v)

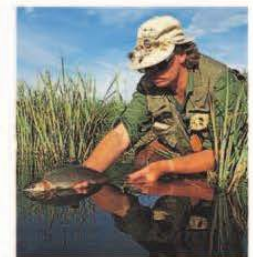

libertar (v)
release (v)

vocabulário • vocabulary

iscar (v)
bait (v)

o material
tackle

a roupa impermeável
waterproofs

a licença de pesca
fishing license

o cesto
creel

morder (v)
bite (v)

o tambor
spool

a vara
pole

a pesca marítima
marine fishing

a pesca com
arpão
spearfishing

o esqui • skiing



as modalidades • events



o esqui downhill
downhill skiing



a porta
gate
o slalom
slalom



o salto
ski jump



o esqui de fundo
cross-country skiing

os desportos de inverno • winter sports



a escalada no gelo
ice climbing



a patinagem no gelo
ice skating



a patinagem artística
figure skating

os óculos
goggles

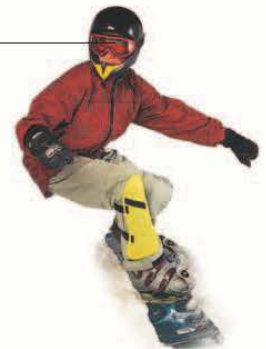

o snowboarding
snowboarding



o bobsleigh
bobsled



o luge
luge



a mota de neve
snowmobile



andar de trenó
sledding

vocabulário • vocabulary

o esqui alpino
alpine skiing

o slalom gigante
giant slalom

fora da pista
Backcountry skiing

o curling
curling

o trenó com cães
dog sledding

a patinagem de
velocidade
speed skating

o biatlo
biathlon

a avalanche
avalanche

outros desportos • other sports

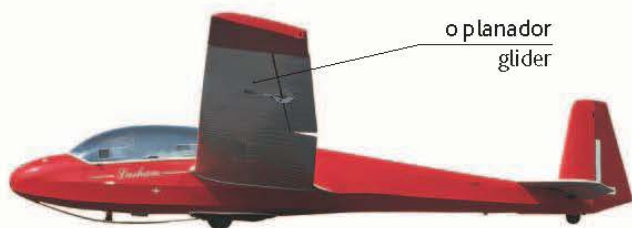

o planador
glider

a asa delta
hang-glider



o voo com asa delta
hang-gilding

o voo planado
gliding

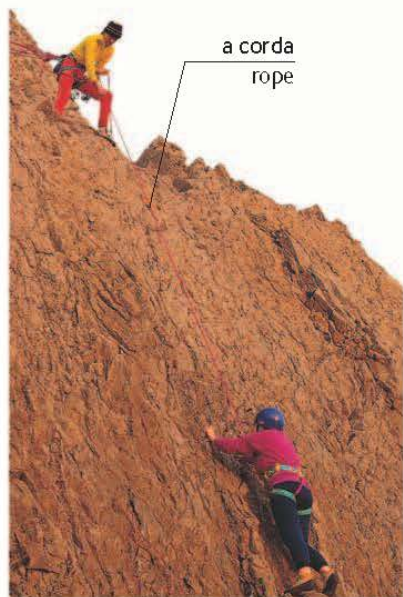

a corda
rope

a escalada
rock climbing



o pára-quadras
parachute

o paraquedismo
parachuting



o parapente
paragliding



o paraquedismo em queda livre
skydiving



o rapel
rapelling



o bungee-jumping
bungee jumping



o rally
rally driving



o automobilismo
motor racing

o piloto de
corridas
racing driver



o motocross
motorcross



o motociclismo
motorcycle racing



andar de skate
skateboarding

o skate
skateboard

o patim
de rodas
rollerskate



a patinagem
roller skating

a raquete
stick



o lacrosse
lacrosse

a máscara
mask

o florete
foil



a esgrima
fencing

o paulito
pin



o bowling
bowling

a flecha
arrow

a aljava
quiver

o arco
bow



o tiro ao arco
archery

o alvo
target



o tiro ao alvo
target shooting

a bola de
bowling
bowling ball



o bilhar americano
pool



o snooker
snooker

a forma física • fitness

a bicicleta fixa
exercise bike

os pesos
free weights

a barra
bar

a máquina de exercício
gym machine

o banco
bench

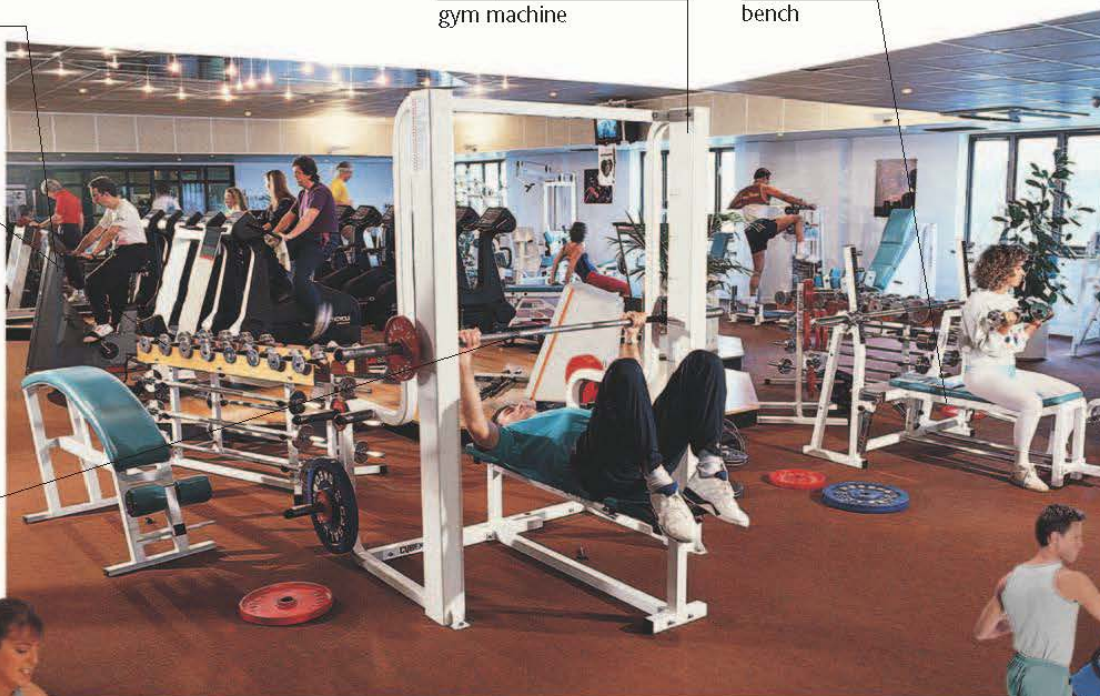

o ginásio
gym



a máquina de remo
rowing machine



a passadeira
treadmill



a bicicleta elíptica
cross trainer



a treinadora pessoal
personal trainer



a máquina de step
step machine



a piscina
swimming pool



a sauna
sauna

os exercícios • exercises

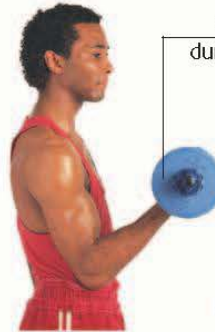
o alongamento
stretcha flexão com alongamento
lungeos collants sem pés
tightsa flexão
push-upo agachamento
squato abdominal
sit-upa rosca bíceps
bicep curlo peso
dumb bello leg press
leg presso chest press
chest presso ténis
gym shoesa barra de pesos
weight baro levantamento de pesos
weight trainingo jogging
joggingo top
vesta aeróbica
aerobics

vocabulário • vocabulary

treinar (v)
train (v)fazer corrida estática (v)
run in place (v)alongar (v)
extend (v)o Pilates
Pilateso treino em circuito
circuit trainingaquecer (v)
warm up (v)flexionar (v)
flex (v)levantar (v)
pull up (v)o boxercise
boxercisesaltar à corda (v)
skipping





o lazer
leisure

o teatro • theater



a cortina
curtain

os bastidores
wings

o cenário
set

o público
audience

a orquestra
orchestra

o palco | stage

vocabulário • vocabulary

o elenco cast	o guião script	a estreia opening night
o actor actor	o pano de fundo backdrop	o intervalo intermission
a actriz actress	o director director	o programa program
a peça play	o produtor producer	o fosso da orquestra orchestra pit

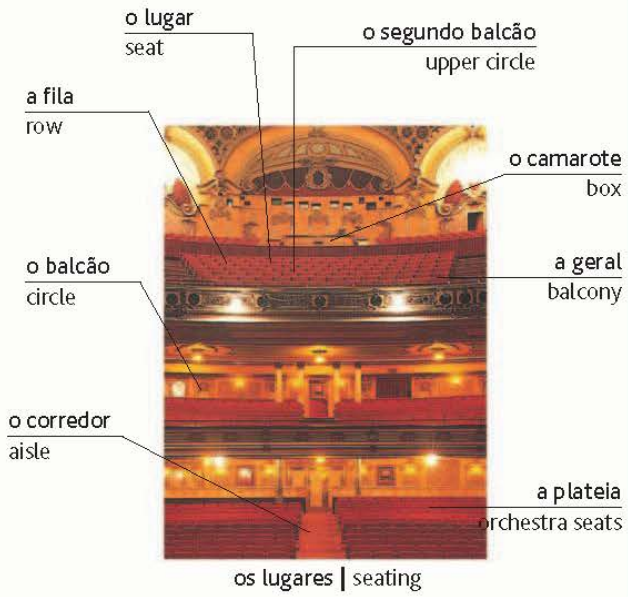

o lugar
seat

o segundo balcão
upper circle

a fila
row

o camarote
box

o balcão
circle

a geral
balcony

o corredor
aisle

a plateia
orchestra seats

os lugares | seating



o concerto | concert



o musical | musical

o traje
costume

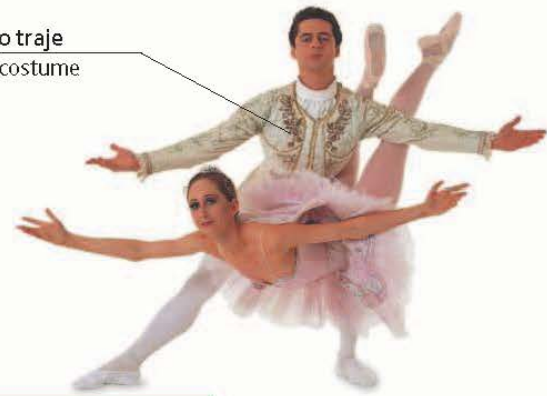

o bailado | ballet

vocabulário • vocabulary

o arrumador
usher

a banda sonora
soundtrack

A que horas começa?
What time does it start?

a música clássica
classical music

aplaudir (v)
applaud (v)

Queria dois bilhetes para a sessão
desta noite.
I'd like two tickets for tonight's
performance.

a partitura
musical score

o bis
encore

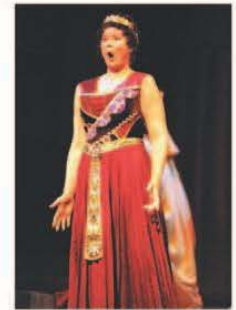

a ópera | opera

o cinema • cinema

as pipocas
popcorn



o foyer
lobby

a bilheteira
box office



o cartaz
poster



o cinema
movie theater



o ecrã
screen

vocabulário • vocabulary

a comédia
comedy

o filme romântico
romance

o filme de suspense
thriller

o filme de ficção científica
science fiction film

o filme de terror
horror film

o filme de aventura
adventure

o filme do oeste
western

o filme de desenhos animados
animated film

a orquestra • orchestra

os instrumentos de corda • strings



o piano | piano

a partitura
score

a clave de fá
bass clef

a clave de sol
treble clef

a nota
note

a pauta
staff



a notação | notation

vocabulário • vocabulary

a abertura
overture

a sonata
sonata

a pausa
rest

sustenido
sharp

natural
natural

a escala
scale

a sinfonia
symphony

os instrumentos
instruments

o tom
pitch

bemol
flat

a barra
bar

a batuta
baton

os instrumentos de sopro de madeira • woodwind



o flautim
piccolo



a flauta
flute



o oboé
oboe



o corne inglês
English horn



o saxofone
saxophone



o clarinete
clarinet



o clarinete baixo
bass clarinet



o fagote
bassoon



o contrafagote
double bassoon

os instrumentos de percussão • percussion



o tímble
kettledrum



o tantã
gong



os bongos
bongos



o tambor pequeno
snare drum



o címbalo
cymbals



a pandeireta
tambourine



o vibrafone
vibraphone



o triângulo
triangle



as maracas
maracas

os instrumentos de sopro de metal • brass



o trompete
trumpet



o trombone
trombone



a trompa
French horn



a tuba
tuba

o concerto • concert



o concerto de rock | rock concert

os instrumentos • instruments

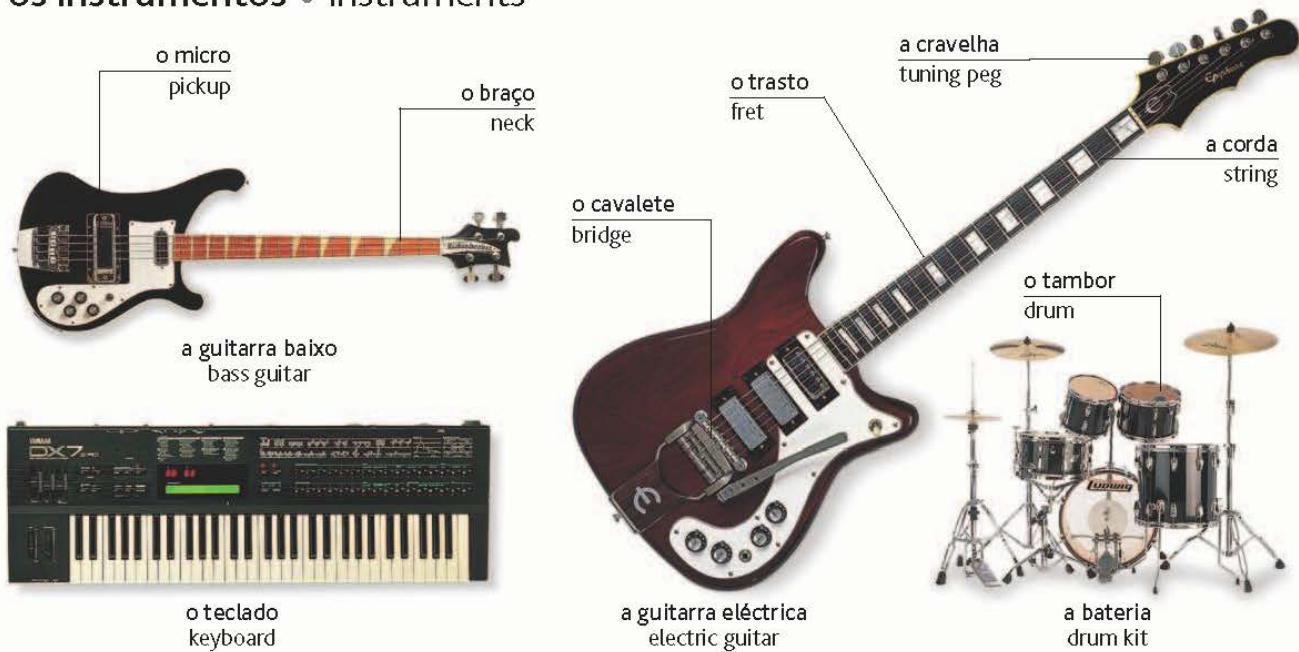

os estilos musicais • musical styles



o jazz | jazz



o blues | blues



o punk | punk



a música folk | folk music



a pop | pop

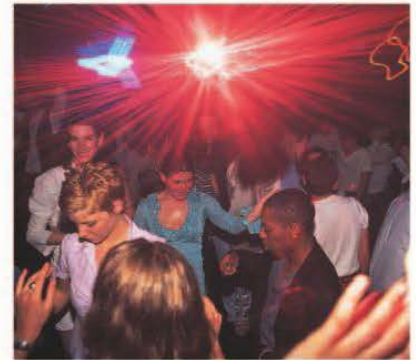

a música de dança | dance



o rap | rap



o heavy metal | heavy metal



a música clássica | classical music

vocabulário • vocabulary

a canção
song

a letra
lyrics

a melodia
melody

o ritmo
beat

o reggae
reggae

a música
country
country

o holofote
spotlight

o turismo • sightseeing



o turista
tourist

a atracção turística | tourist attraction



o itinerário
itinerary

descoberto
open-top

o autocarro turístico | tour bus

a guia
turística
tour guide



a visita guiada
guided tour

a estatueta
statuette

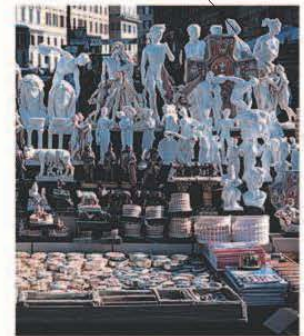

as recordações
souvenirs

vocabulário • vocabulary

aberto
open

o guia
guide book

a câmara de vídeo
camcorder

esquerda
left

Onde fica...?
Where is...?

fechado
closed

o filme
film

a máquina
fotográfica
camera

direita
right

Perdi-me.
I'm lost.

o preço da entrada
admission charge

as pilhas
batteries

as indicações
directions

a direito
straight ahead

Pode indicar-me o caminho para...?
Can you tell me the way to...?

as atrações • attractions

o quadro
painting



a galeria de arte
art gallery

a peça exposta
exhibit

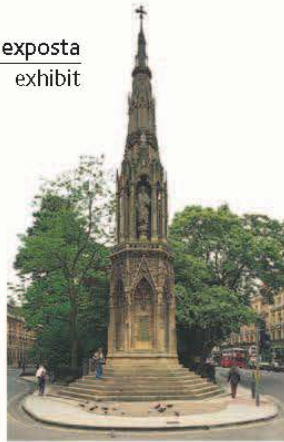

o monumento
monument

a exposição
exhibition

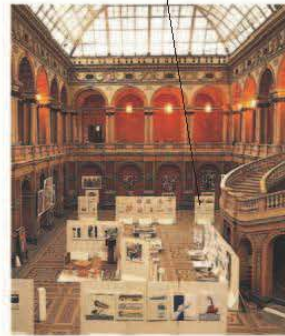

o museu
museum

as ruínas famosas
famous ruin



o edifício histórico
historic building



o casino
casino

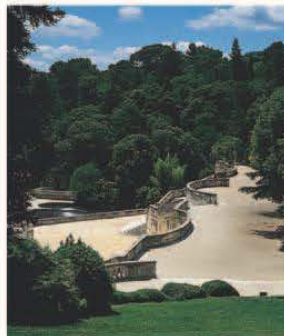

os jardins
gardens



o parque nacional
national park

a informação • information

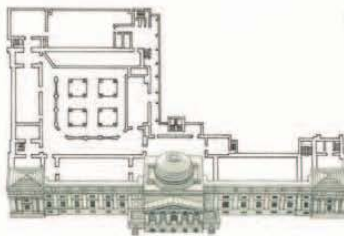

a planta
floor plan



o mapa
map

as horas
times



o horário
timetable



o posto de informação
turística
tourist information

as actividades ao ar livre • outdoor activities

o caminho
para peões
footpath

o relógio de sol
sundial

o café
café



o parque | park

a relva
grass

o banco
bench

os jardins
clássicos
formal gardens

a montanha russa
roller coaster

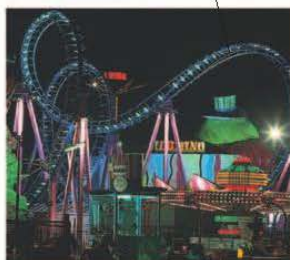

a feira
fairground



o parque temático
theme park



o parque de safari
safari park



o jardim zoológico
zoo

as actividades • activites



o ciclismo
cycling



o jogging
jogging



andar de skate
skateboarding



a patinagem
rollerblading

o caminho equestre
bridle path



a ornitologia
bird watching



a equitação
horseback riding



o pedestriano
hiking

a cesta
hamper



o piquenique
picnic

o parque infantil • playground



a caixa de areia
sandpit



a piscina plástica
paddling pool



os baloiços
swings



o balancé | seesaw



o escorrega | slide



a estrutura para escalar
climbing frame

a praia • beach

o hotel
hotel

o guarda-sol
beach umbrella

o toldo
beach hut

a areia
sand

a onda
wave

o mar
sea



o saco de praia
beach bag

o biquini
bikini



tomar banhos de sol (v) | sunbathe (v)



o salva-vidas
lifeguard

a torre de vigilância
lifeguard tower



o corta-vento
windbreak



o passeio marítimo
promenade



a espreguiçadeira
deck chair



os óculos de sol
sunglasses



o chapéu de sol
sunhat



o creme solar
suntan lotion



o protector solar total
sunblock



a bola de praia
beach ball



a bóia
rubber ring

o fato de banho
swimsuit

a pá
shovel

o balde
bucket

o castelo de areia
sandcastle

a concha
shell



a toalha de praia
beach towel

o campismo • camping

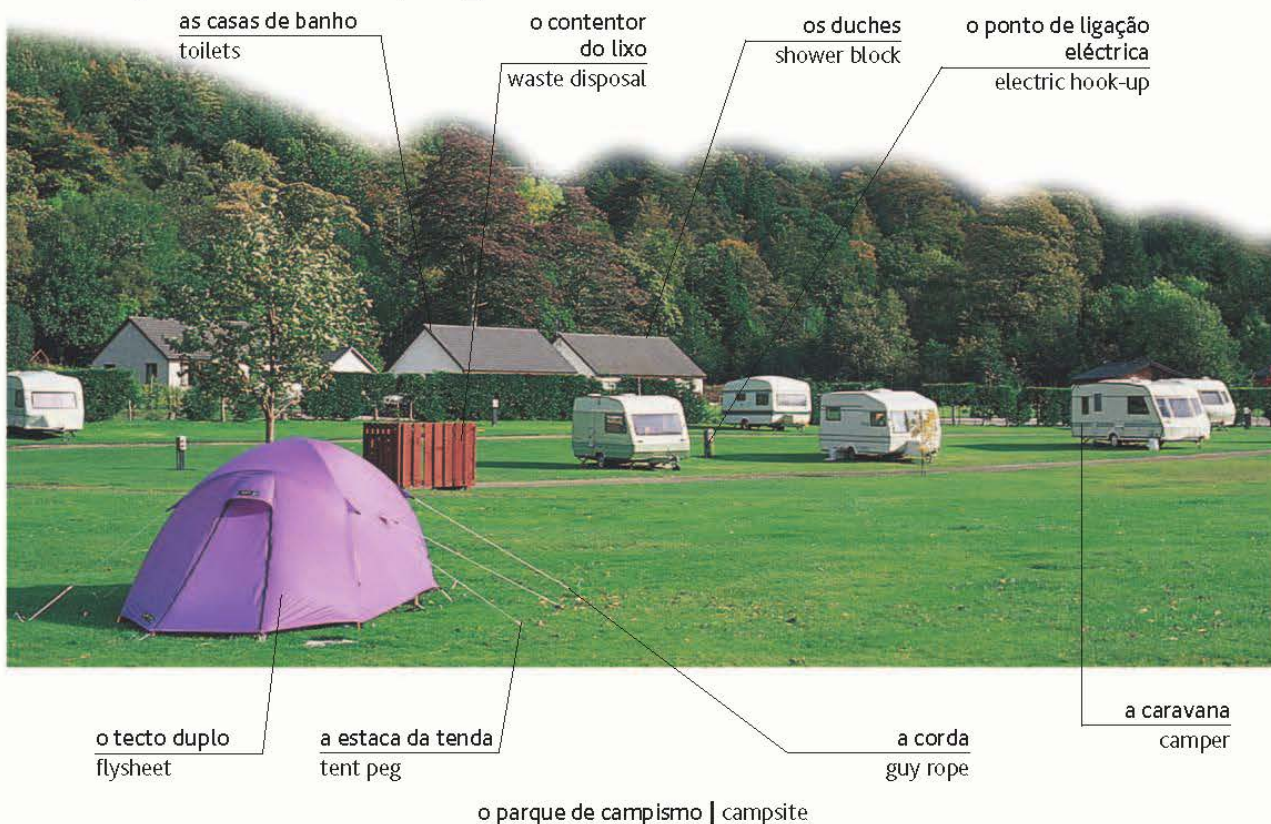

vocabulário • vocabulary

acampar (v)
camp (v)

o escritório do chefe do parque
site manager's office

há lugares disponíveis
pitches available

cheio
full

o lugar
pitch

montar uma tenda (v)
pitch a tent (v)

a estaca da tenda
tent pole

a cama de campismo
camp bed

a mesa de piquenique
picnic bench

a cama de rede
hammock

a roulotte
camper van

o atrelado
trailer

o carvão
charcoal

a acendalha
firelighter

acender uma fogueira (v)
light a fire (v)

a fogueira
campfire



o repelente de insectos
insect repellent



a lanterna
flashlight

o mosquito
mosquito net



a roupa termo-
isolante
thermals



as botas de trekking
hiking boots



a roupa impermeável
rain slicker



o saco de dormir
sleeping bag



o fogão de campismo
camping stove



o churrasco
barbecue

a esteira
sleeping mat



o colchão insuflável | air mattress

o entretenimento no lar • home entertainment



o discman
personal CD player



o gravador de
minidiscos
mini disk recorder



o leitor de MP3
MP3 player



o DVD
DVD disk

o leitor de DVD
DVD player

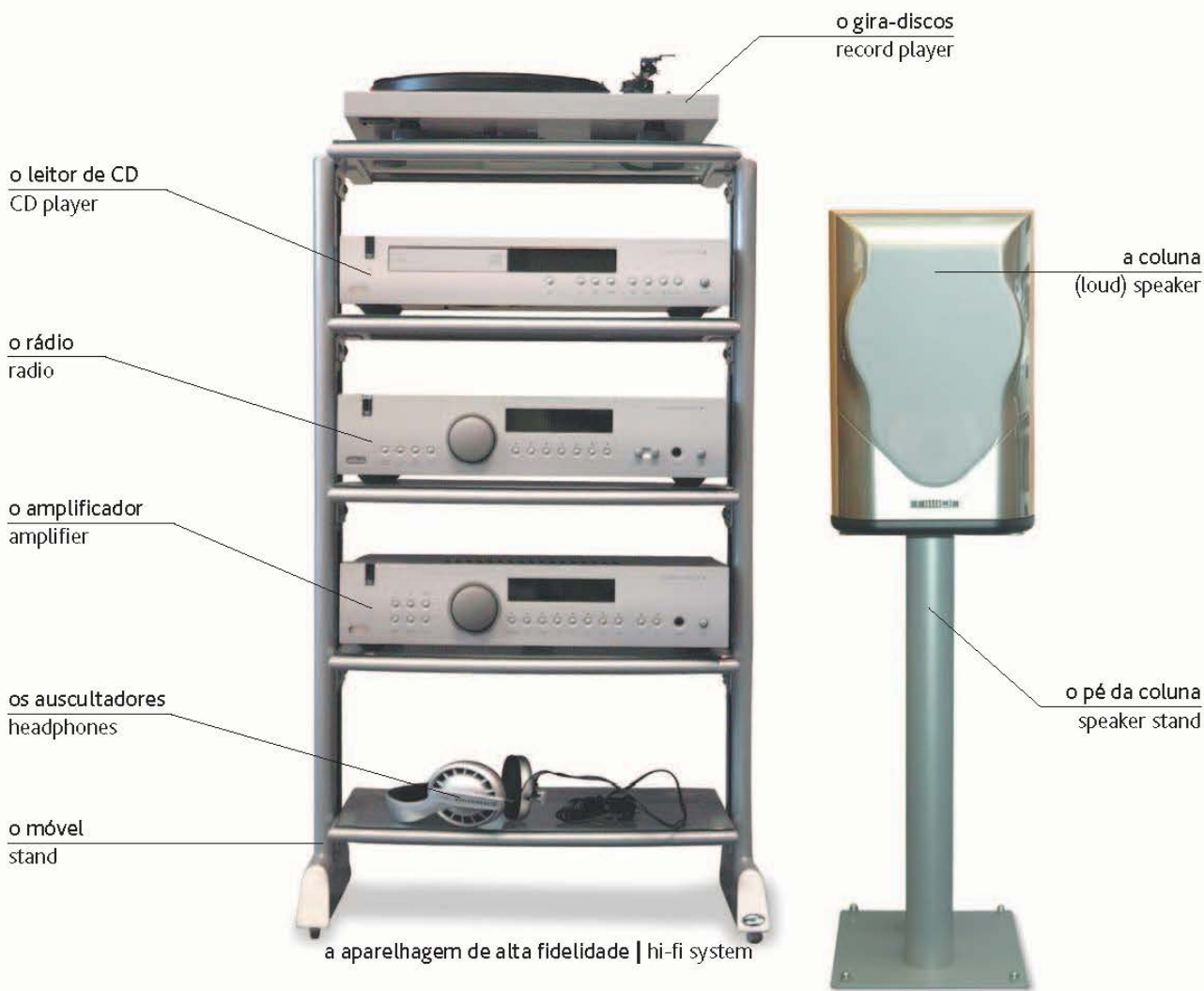



a cassette de vídeo
video tape

o gravador de vídeo
video recorder

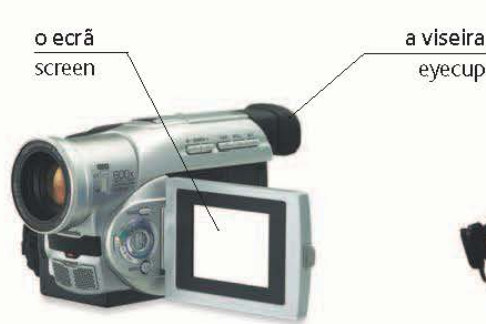

o ecrã
screen

a viseira
eyecup

a câmara de vídeo
camcorder



a antena parabólica
satellite dish



o televisor de ecrã
panorâmico
widescreen television



a consola
console



o comando
controller

o jogo de vídeo | video game



o avanço rápido
fast forward

a pausa
pause

gravar
record

o volume
volume

rebobinar (v)
rewind

ler
play

parar
stop

o telecomando | remote control

vocabulário • vocabulary

o disco compacto
compact disc

o longa metragem
feature film

o programa
program

o canal pay-per-view
pay per view channel

ver a televisão (v)
watch television (v)

a cassette
cassette tape

o anúncio
advertisement

o estéreo
stereo

mudar de canal (v)
change channel (v)

desligar a televisão (v)
turn the television off (v)

o leitor de cassetes
cassette player

digital
digital

a televisão
por cabo
cable television

ligar a televisão (v)
turn the television
on (v)

sintonizar o rádio (v)
tune the radio (v)

a fotografia • photography



o flash electrónico
flash gun



o fotómetro
lightmeter



a teleobjectiva
zoom lens



o tripé
tripod

os tipos de câmara • types of camera



a câmara digital
digital camera



a câmara APS
APS camera



a câmara Polaroid
instant camera



a câmara descartável
disposable camera

fotografar (v) • photograph (v)

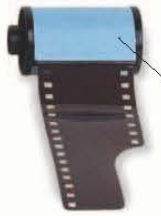

a película
film

o rolo
film spool



focar (v)
focus (v)

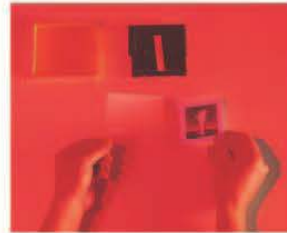

revelar (v)
develop (v)

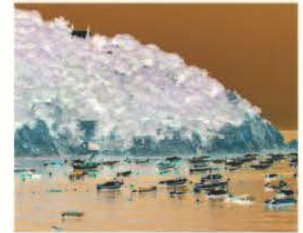

o negativo
negative

o formato
horizontal
landscape



a fotografia | photograph

o formato
vertical
portrait

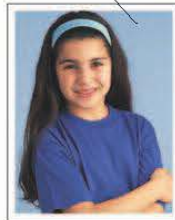

o álbum de fotografias
photo album



a moldura
photo frame

os problemas • problems

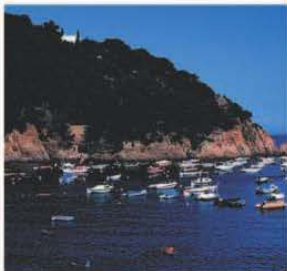

subexposto
underexposed



sobrexposto
overexposed



desfocado
out of focus



os olhos vermelhos
red eye

vocabulário • vocabulary

o visor
viewfinder

o estojo da câmara
camera case

a exposição
exposure

a câmara escura
darkroom

a foto (revelada)
print

mate
matte

brilhante
gloss

a ampliação
enlargement

Gostaria de revelar este rolo.
I'd like this film processed

os jogos • games

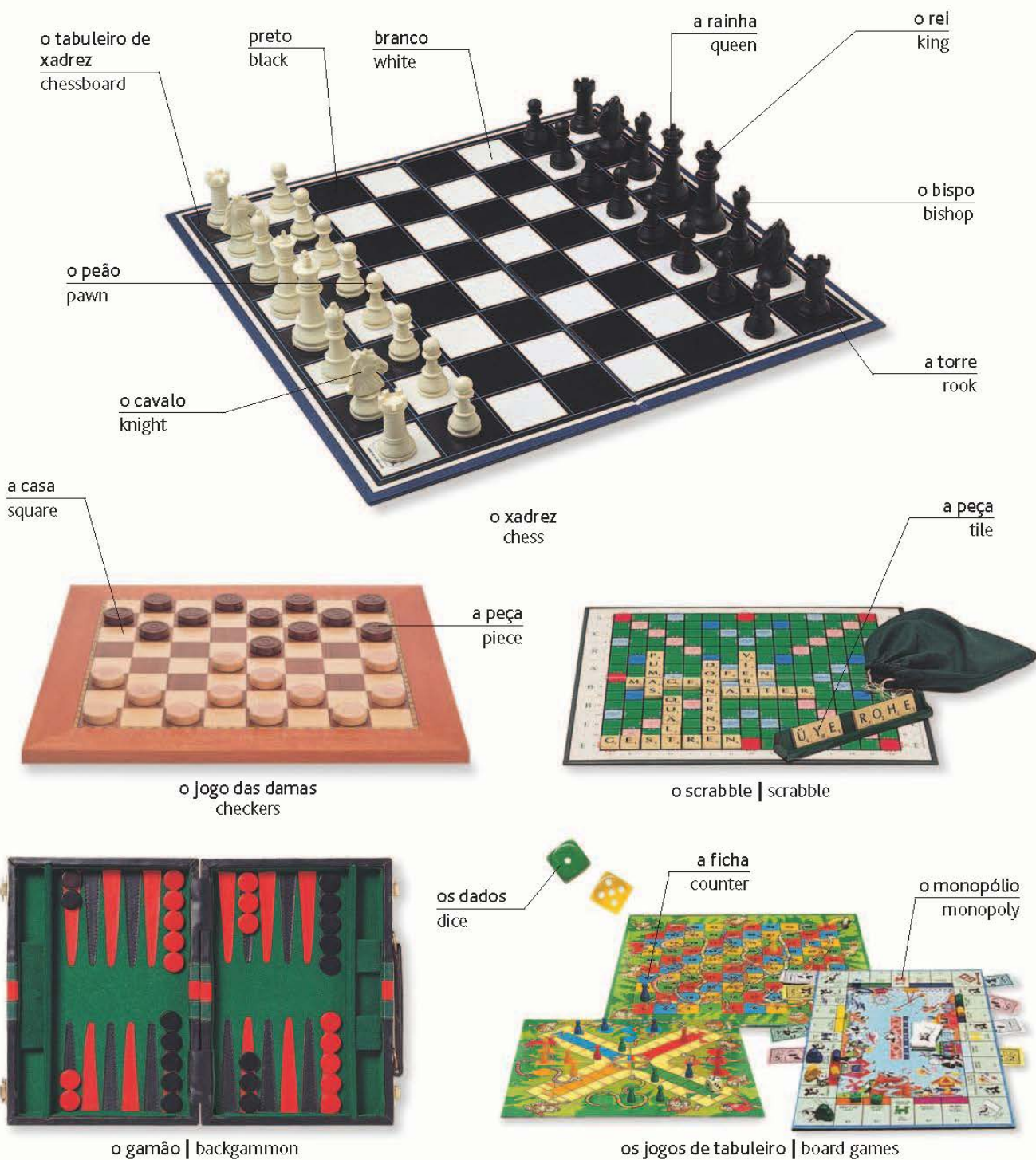

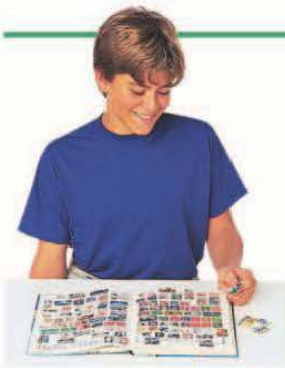

a filatelia | stamp collecting



o puzzle | jigsaw puzzle

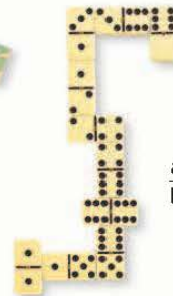

os dominós | dominoes

o alvo
dartboard

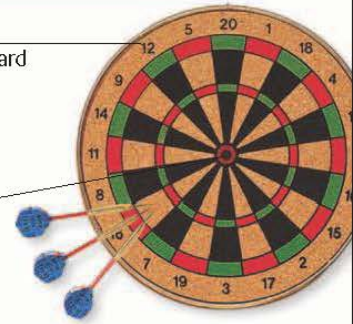

a mosca
bullseye

as setas | darts

o joker
joker

o valete
jack

a rainha
queen

o rei
king

o ás
ace

as cartas | cards



ouros
diamond

espadas
spade

copas
heart

paus
club



baralhar (v) | shuffle (v)



dar as cartas (v) | deal (v)

vocabulário • vocabulary

a jogada
move

ganhar (v)
win (v)

o perdedor
loser

o ponto
point

o bridge
bridge

Lança os dados.
Roll the dice.

jogar (v)
play (v)

o vencedor
winner

o jogo
game

a pontuação
score

o baralho
pack of cards

É a vez de quem?
Whose turn is it?

o jogador
player

perder (v)
lose (v)

a aposta
bet

o poker
poker

o naipe
suit

É a tua vez.
It's your move.

as artes manuais • arts and crafts 1

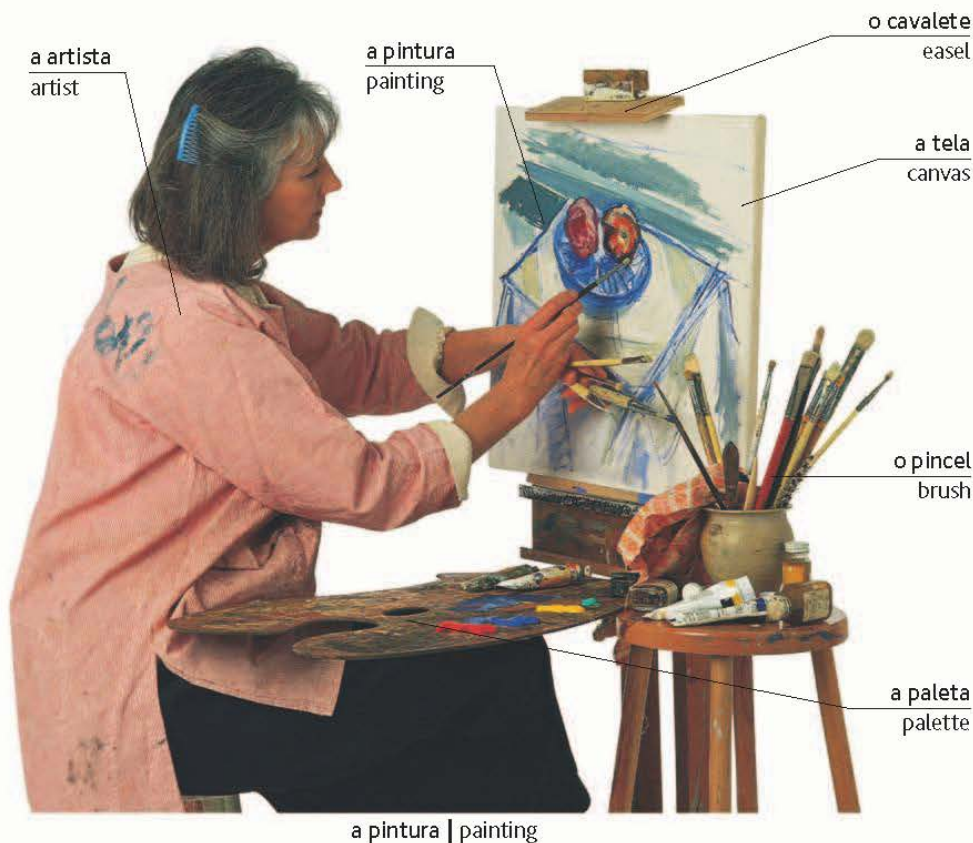

as tintas • paints



as tintas de óleo
oil paints



as aguarelas
watercolor paint



os pastéis
pastels



a tinta acrílica
acrylic paint



o guache
poster paint

as cores • colors



vermelho | red



azul | blue



amarelo | yellow



verde | green



laranja
orange



roxo | purple



branco | white



preto | black



cinzento | grey



rosa | pink



castanho | brown



anil | indigo

outras artes manuais • other crafts

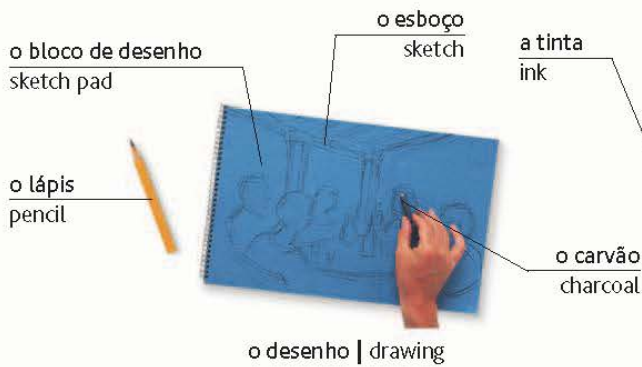

as artes manuais 2 • arts and crafts 2



a tesoura
scissors



o molde
pattern



a fita métrica
tape measure



o tecido
material



a almofada de alfinetes
pin cushion

o alfinete
pin

o cesto de costura
sewing basket



a bobina
bobbin



a linha
thread



o colchete
fêmea
eye

o colchete macho
hook



o dedal
thimble



o marcador
tailor's chalk



o manequim
tailor's dummy

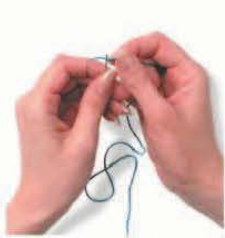

enfiar (v)
thread (v)



coser (v)
sew (v)



cerzir (v)
darn (v)



alinhar (v)
tack (v)



cortar (v)
cut (v)



a tapeçaria
needlepoint



o bordado
embroidery

a agulha de
crochet
crochet hook



o crochet
crochet



o macramé
macramé



o trabalho de
retalhos
patchwork



o acolchoado
quiltting



a renda de bilros
lace-making



a tecelagem
weaving

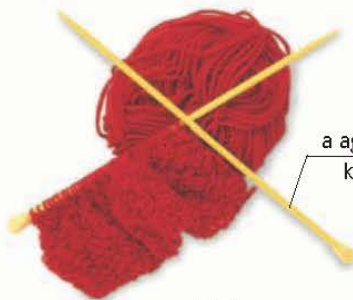

a agulha de tricô
knitting needle

o tricô
knitting



a lâ
wool

a meada | skein

vocabulário • vocabulary

descoser (v)
unpick (v)

o nylon
nylon

o tecido
fabric

a seda
silk

o algodão
cotton

o estilista
designer

o linho
linen

a moda
fashion

o poliéster
polyester

o fecho
zipper





o ambiente
environment



o espaço • space

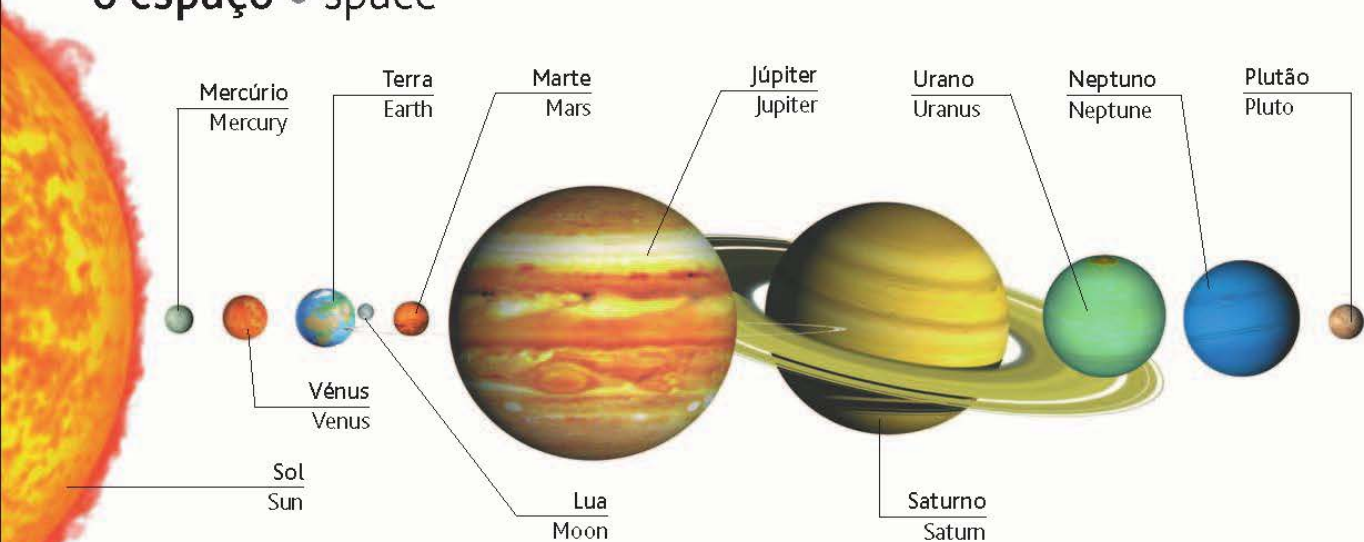

o sistema solar | solar system

a cauda tail
a estrela star



a galáxia galaxy



a nebulosa nebula



o asteróide asteroid



o cometa comet

vocabulário • vocabulary

o universo
universe

o buraco negro
black hole

a lua cheia
full moon

a órbita
orbit

o planeta
planet

a lua nova
new moon

a gravidade
gravity

o meteoro
meteor

o quarto
crescente
crescent moon



o eclipse | eclipse

a exploração do espaço • space exploration

o vaivém espacial
space shuttle

o lança-foguetes
booster



o lançamento
launch

o fato espacial
space suit



o astronauta | astronaut

o propulsor
thruster

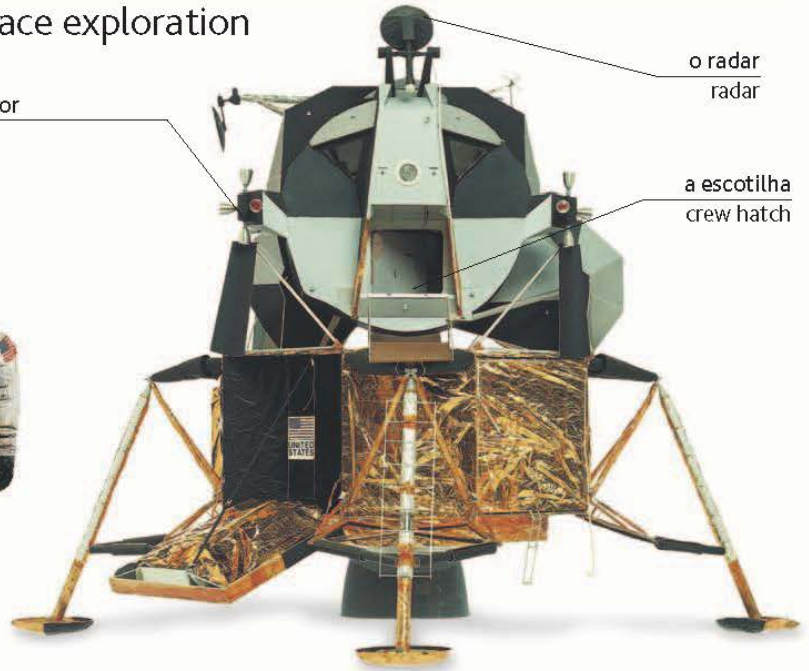

o radar
radar

a escotilha
crew hatch

o módulo lunar | lunar module

a rampa de lançamento
launch pad



o satélite
satellite



a estação espacial
space station

a astronomia • astronomy



a constelação
constellation



o binóculo
binoculars

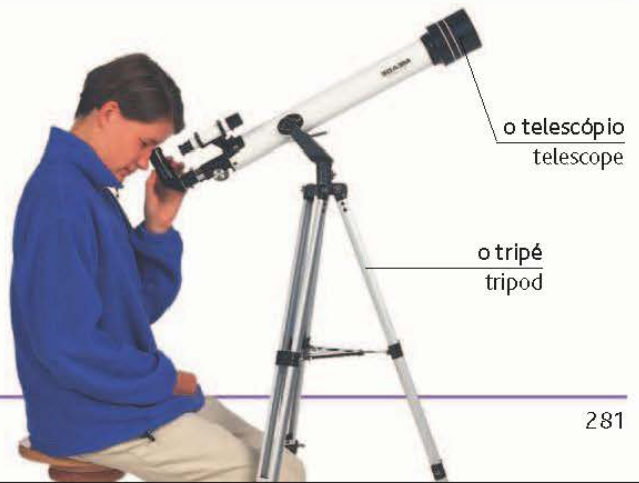

o telescópio
telescope

o tripé
tripod

a Terra • Earth

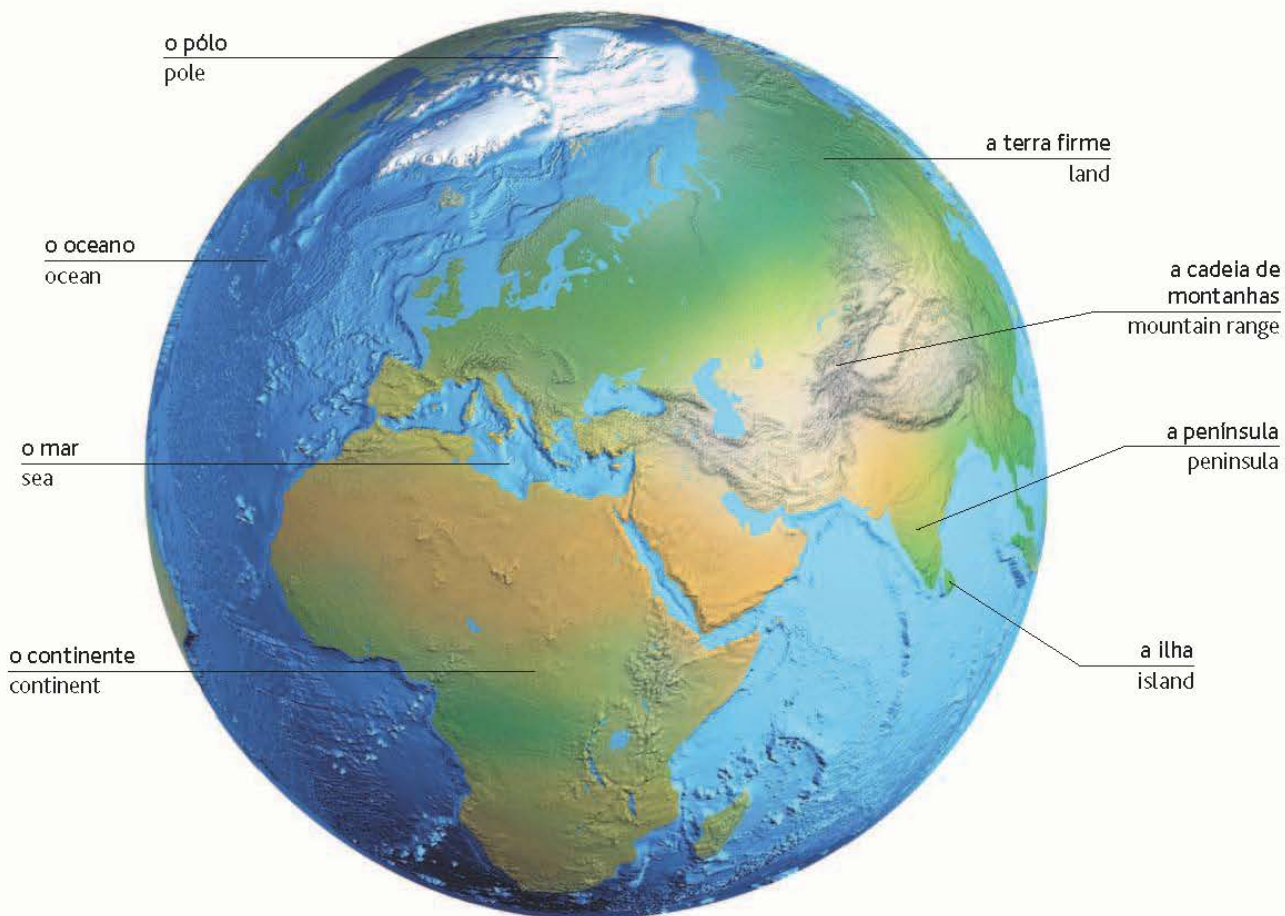

o planeta | planet

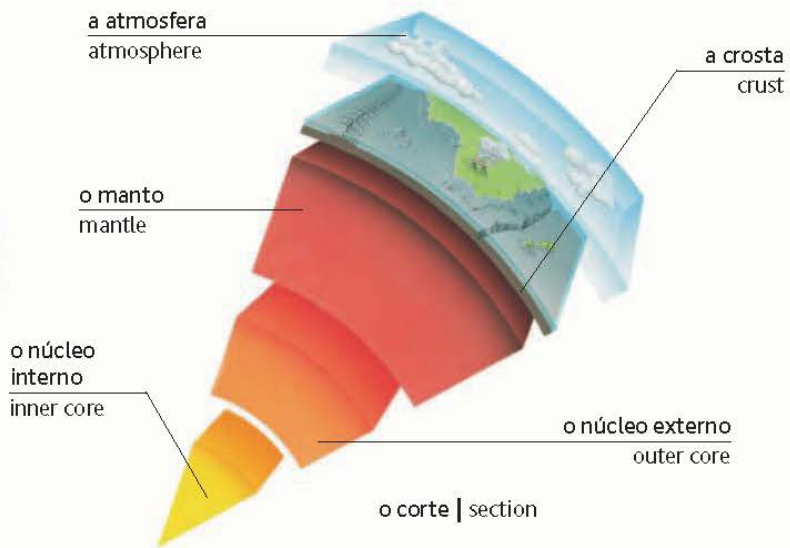

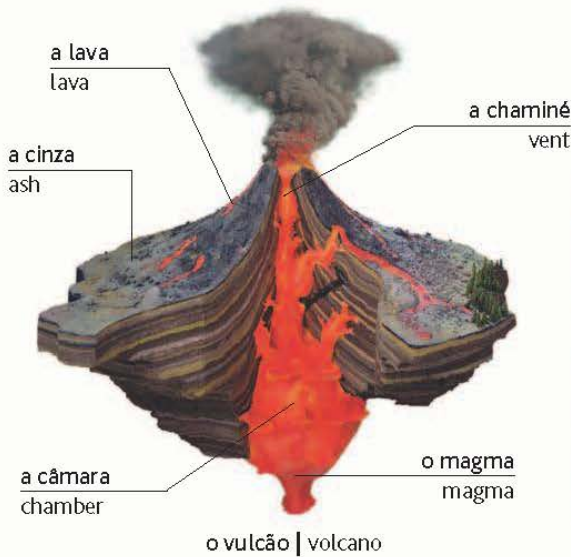
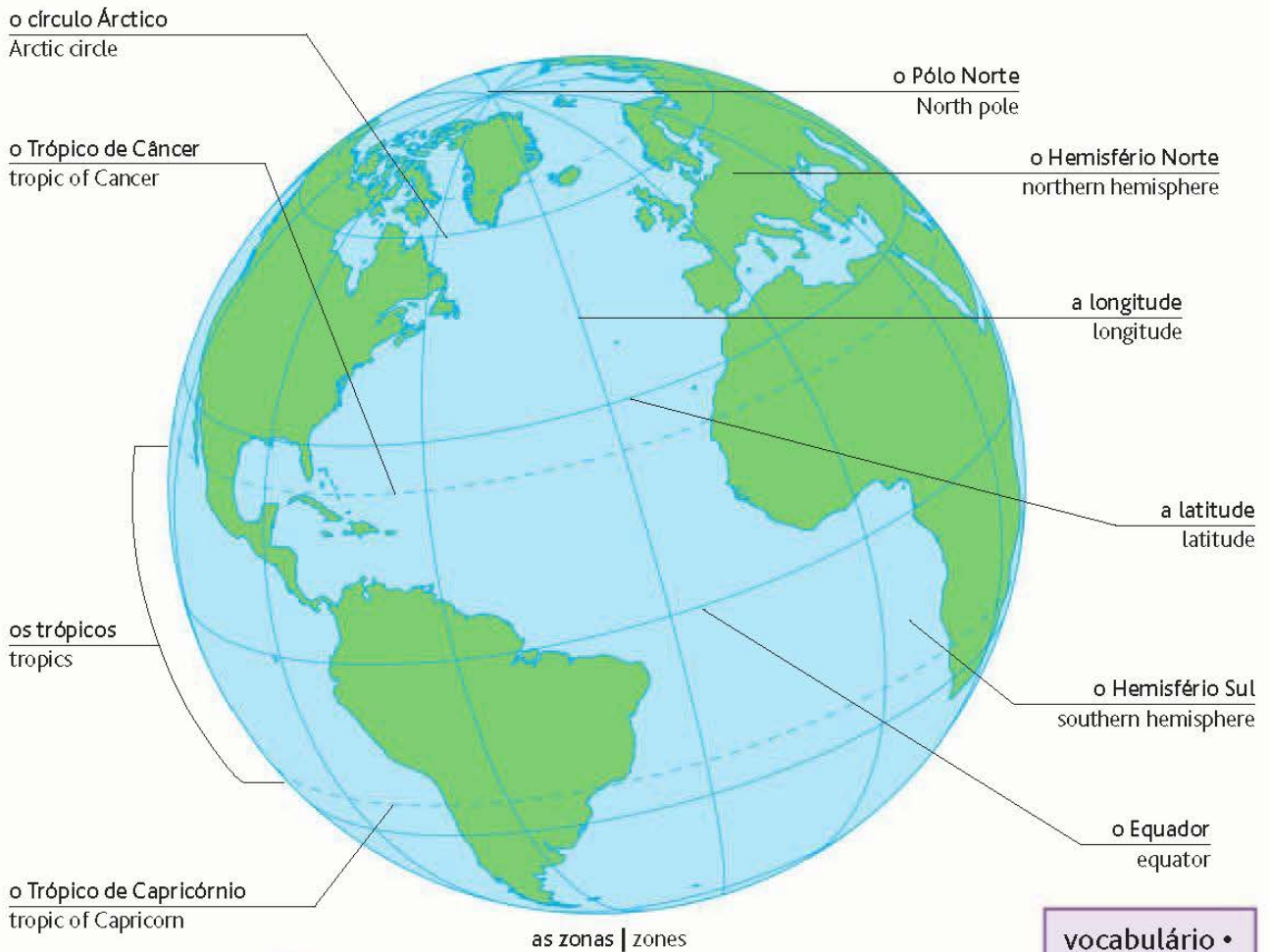

a cratera | crater

**vocabulário •
vocabulary**

o terramoto
earthquake

a placa
plate

entrar em erupção
(v)
erupt (v)

o tremor
tremor

a paisagem • landscape

a montanha
mountain

a encosta
slope

a margem
bank

o rio
river

os rápidos
rapids

as rochas
rocks

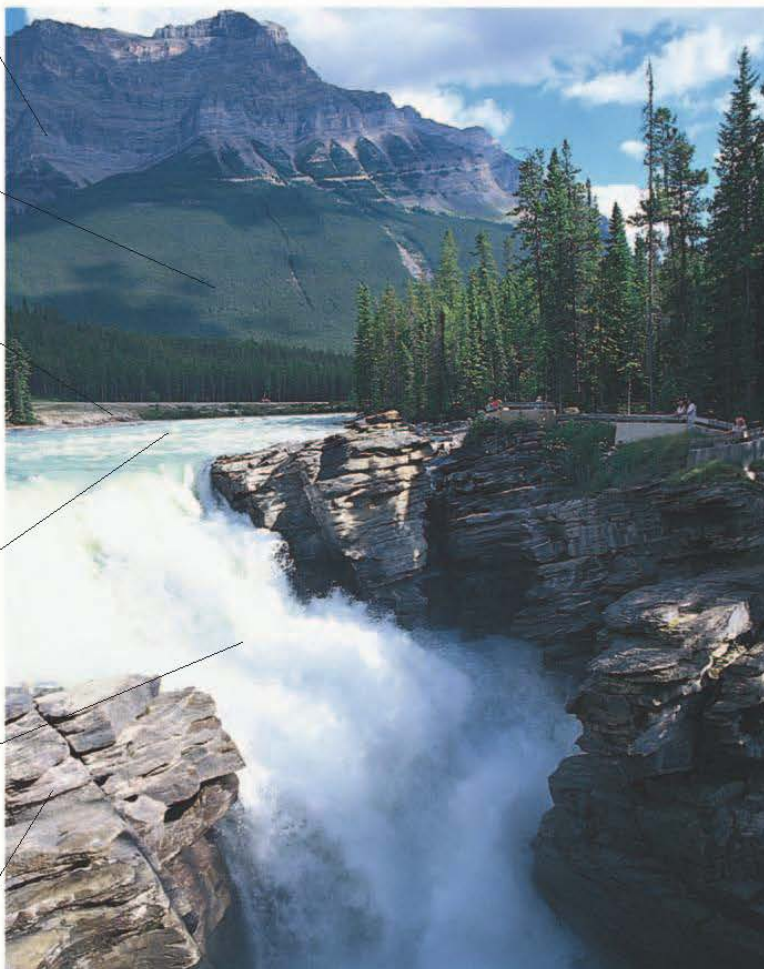

o glaciar
glacier



o vale | valley

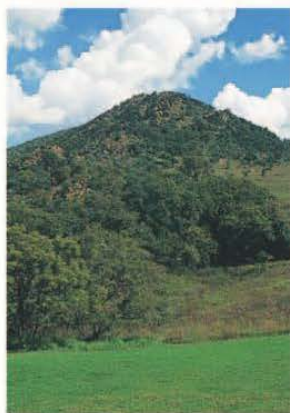

a colina
hill

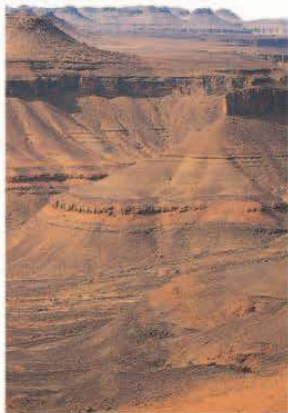

o planalto
plateau



o desfiladeiro
gorge

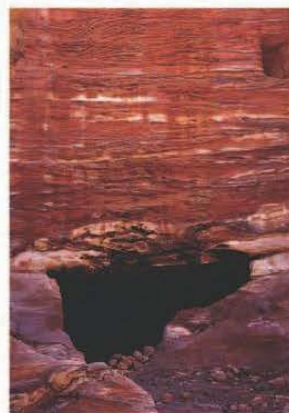

a caverna
cave



a planície | plain



o deserto | desert



a floresta | forest



o bosque | wood



a floresta tropical
rain forest



o pântano
swamp



o prado
meadow



a pradaria
grassland



a queda de água
waterfall

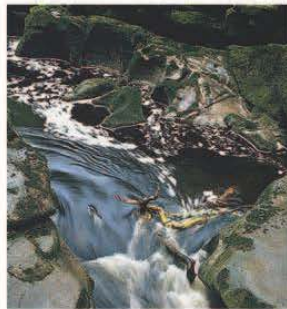

o ribeiro
stream



o lago
lake



o géiser
geyser



a costa
coast



o penhasco
cliff



o recife de coral
coral reef

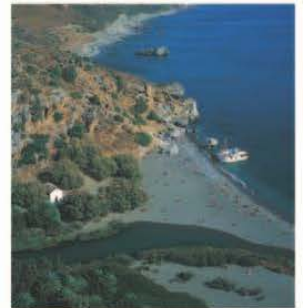

o estuário
estuary

o tempo • weather

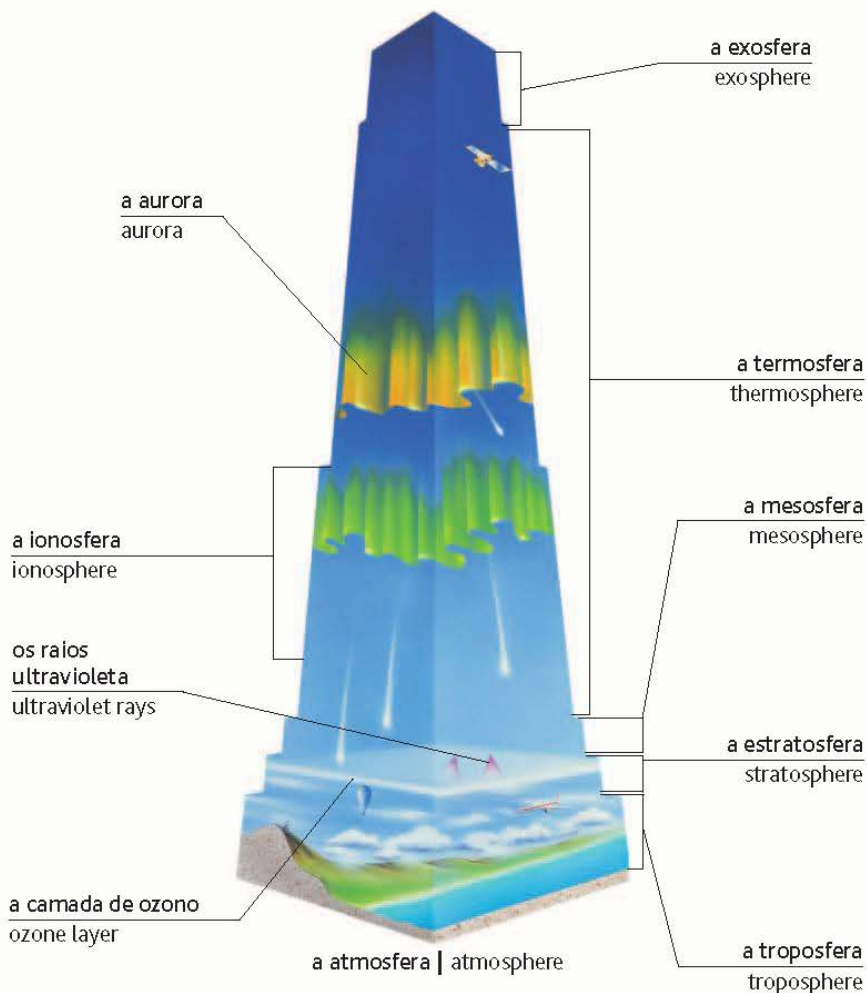

o sol | sunshine

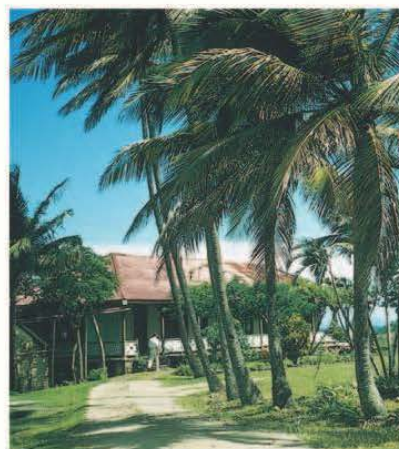

o vento | wind

vocabulário • vocabulary

a chuva com neve sleet	o aguaceiro shower	muito quente hot	seco dry	ventoso windy	Tenho calor/frio. I'm hot/cold.
o granizo hail	soalheiro sunny	frio cold	chuvoso wet	o temporal gale	Está a chover. It's raining.
o trovão thunder	nublado cloudy	quente warm	húmido humid	a temperatura temperature	A temperatura é de... graus. It's ... degrees.



a nuvem | cloud



a chuva | rain

o relâmpago
lightning



a tempestade | storm

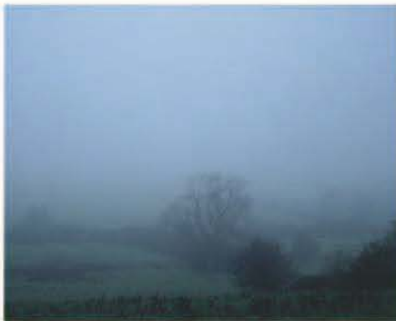

a neblina | mist



o nevoeiro | fog



o arco-íris | rainbow



a neve | snow



a geada | frost

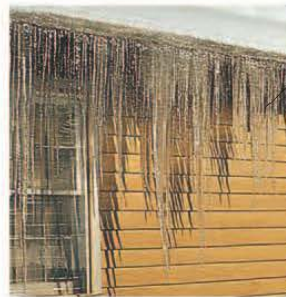

o gelo | ice

o sincelo
icicle



a vaga de frio | freeze



o furacão | hurricane



o tornado | tornado



a monção | monsoon



a inundação | flood

as rochas • rocks

ígneas • igneous



o granito
granite



a obsidiana
obsidian



o basalto
basalt



a pedra-pomes
pumice

sedimentares • sedimentary



o arenito
sandstone



a pedra calcária
limestone



o cré
chalk

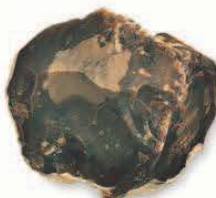

a pederneira
flint



o conglomerado
conglomerate



o carvão
coal

metamórficas • metamorphic



a ardósia
slate



o xisto
schist



o gnaiss
gneiss



o mármore
marble

as pedras preciosas • gems

o rubi
ruby



a ametista
amethyst



o azeviche
jet



a opala
opal



a pedra lunar
moonstone



a granada
garnet



o diamante
diamond



a água-marinha
aquamarine



o jade
jade



a esmeralda
emerald



a safira
sapphire



a turmalina
tourmaline



o topázio
topaz



os minerais • minerals



o quartzo
quartz



a mica
mica



a pirite
sulfur



a hematite
hematite



a calcite
calcite



a malaquite
malachite



a turquesa
turquoise



o ónix
onyx

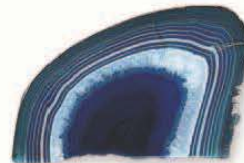

a ágata
agate



a grafite
graphite

os metais • metals



o ouro
gold



a prata
silver



a platina
platinum



o níquel
nickel



o ferro
iron



o cobre
copper



o estanho
tin



o alumínio
aluminum



o mercúrio
mercury



o zinco
zinc

os animais 1 • animals 1

os mamíferos • mammals



o coelho
rabbit



o hamster
hamster

o bigode
whiskers



o rato
mouse

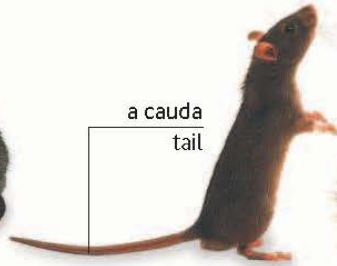

a cauda
tail

a ratazana
rat



o ouriço
hedgehog



o esquilo
squirrel



o morcego
bat



o guaxinim
raccoon



a raposa
fox

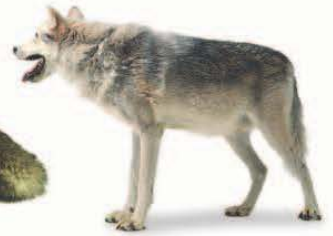

o lobo
wolf

o cachorro
puppy



o cão
dog

o gatinho
kitten



o gato
cat

a cria
pup



a lontra
otter



a foca
seal



o leão marinho
sea lion

a barbatana
flipper

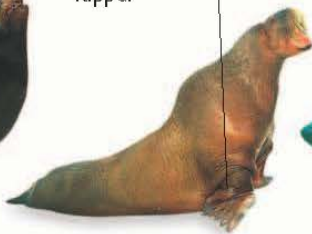

a morsa
walrus

o orifício nasal
blowhole



a baleia
whale



o golfinho
dolphin



o veado
deer

o chifre
antler

a crina
mane

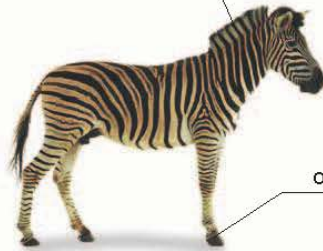

a zebra
zebra

o casco
hoof



a girafa
giraffe

a corcova
hump



o dromedário
camel



o hipopótamo
hippopotamus

a tromba
trunk

o dente
tusk

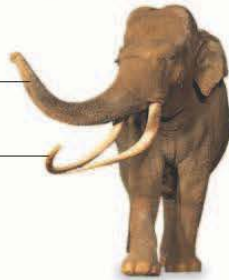

o elefante
elephant

o corno
horn



o rinoceronte
rhinoceros



o tigre
tiger



o leão
lion

a juba
mane



o macaco
monkey



o gorila
gorilla



o koala
koala

a bolsa
pouch

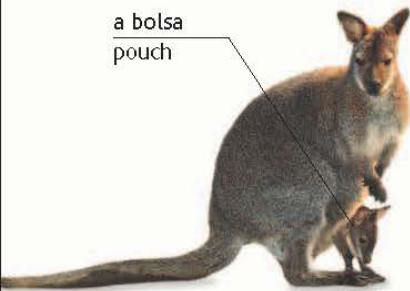

o canguru
kangaroo



o urso
bear

a garra
claw



o urso polar
polar bear

o panda
panda



os animais 2 • animals 2

as aves • birds



o canário
canary



o pardal
sparrow



o colibri
hummingbird

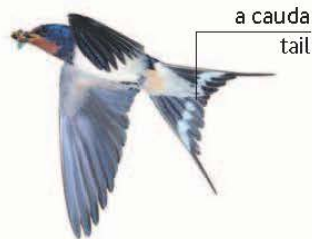

a andorinha
swallow



o corvo
crow



o pombo
pigeon



o pica-pau
woodpecker



o falcão
falcon



o mocho
owl



a gaivota
gull

a águia
eagle



o pelicano
pelican



o flamingo
flamingo



a cegonha
stork



o grou
crane



o pinguim
penguin



a avestruz
ostrich



o ganso | goose



o cisne
swan



o pavão
peacock



o faisão
pheasant



o peru
turkey



a catatua
cockatoo

o bico
bill



a pena
feather

a asa
wing

a garra
claw

o papagalo
parrot

os répteis • reptiles

as escamas
scales



o jacaré
alligator



o lagarto
lizard

a iguana
iguana

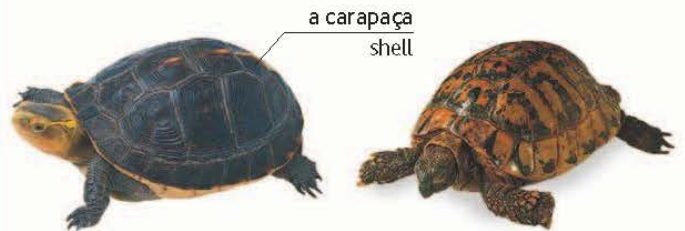

a carapaça
shell

a tartaruga marinha
turtle

a tartaruga terrestre
tortoise

a serpente
snake



o focinho
snout



o crocodilo
crocodile

os animais 3 • animals 3

os anfíbios • amphibians



a rã
frog



o sapo
toad



o girino
tadpole



a salamandra
salamander

os peixes • fish



a enguia
eel

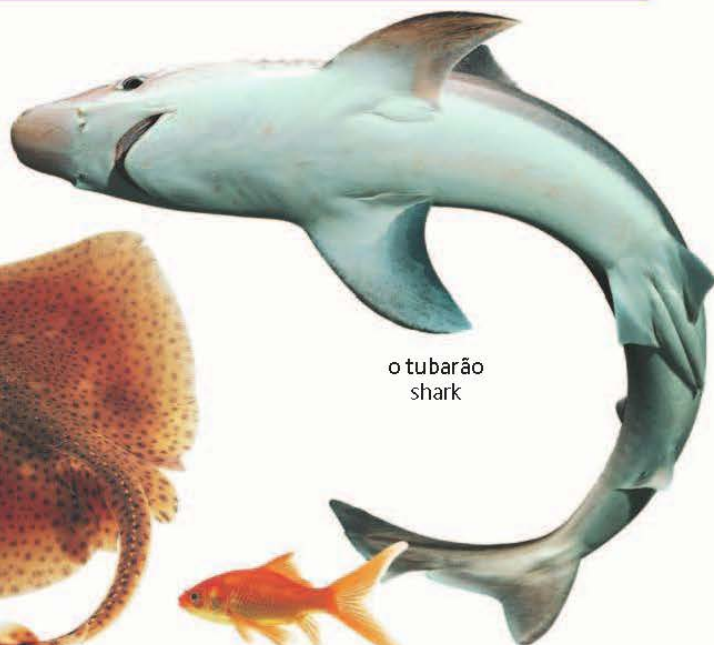

o tubarão
shark



o cavalo marinho
sea horse



a raia ovípara
skate

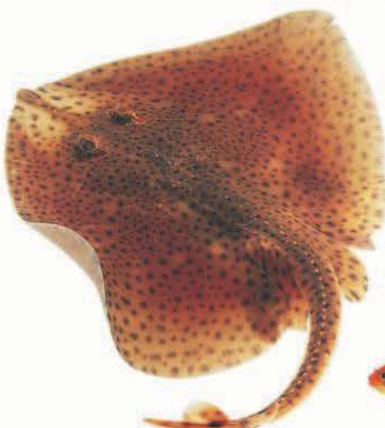

a raia vivípara
ray



o peixe-dourado
goldfish

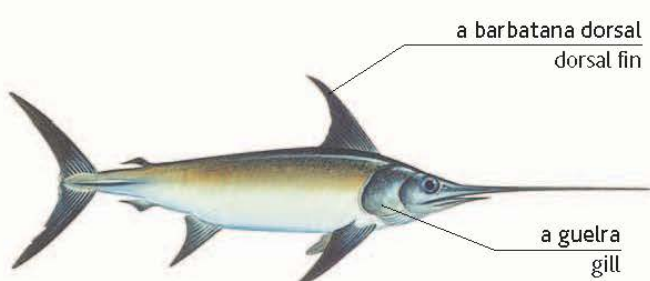

o peixe-espada | swordfish

a barbatana dorsal
dorsal fin

a gueltra
gill

a barbatana peitoral
pectoral fin

a cauda
tail

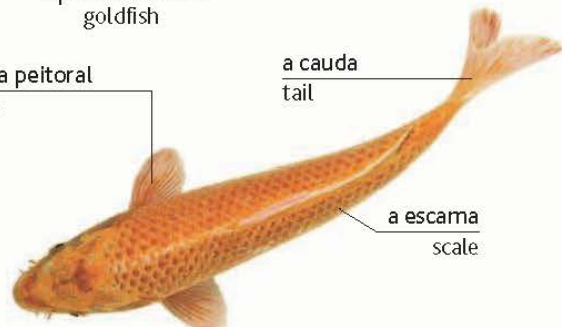

a carpa koi | koi carp

a escama
scale

os invertebrados • invertebrates



a formiga
ant



a térmite
termite



a abelha
bee



a vespa
wasp



o escaravelho
beetle



a barata
cockroach



a mariposa
moth



a borboleta
butterfly

a antena
antenna



o casulo
cocoon



a lagarta
caterpillar



o grilo | cricket



o gafanhoto
grasshopper



o louva-a-deus
praying mantis



a picada
sting

o escorpião
scorpion



a centopeia
centipede



a libelinha
dragonfly



a mosca
fly



o mosquito
mosquito



a joaninha
ladybug



a aranha
spider



a lesma
slug



o caracol
snail



a minhoca | worm



a estrela-do-mar
starfish



o mexilhão
mussel



o caranguejo | crab



homar | lobster



o polvo | octopus



a lula | squid



a alforreca | jellyfish

as plantas • plants

a árvore • tree

o ramo
branch

a raiz
root

o tronco
trunk

a casca
bark

a folha
leaf

o raminho
twig



o salgueiro
willow

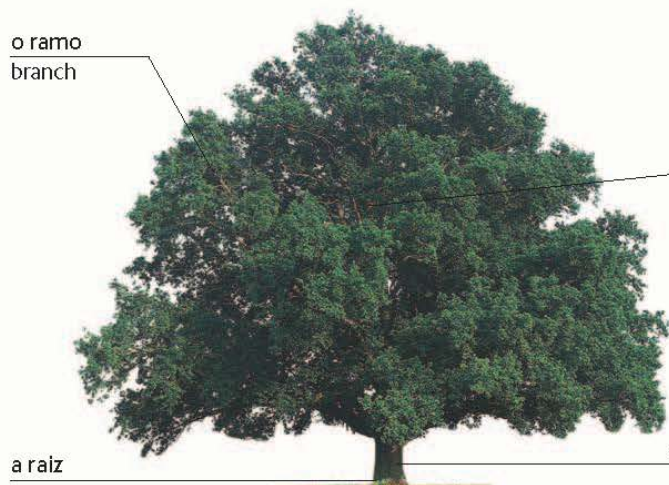

o carvalho | oak

a casca
bark



o álamo
poplar



o eucalipto
eucalyptus



o larício
larch



a faia
beech



a bétula
birch



o pinheiro
pine



o cedro
cedar



o ácer
maple



o olmo
elm



a tília
linden



o azevinho
holly

a baga
berry



a palmeira
palm

a planta de flor • flowering plant

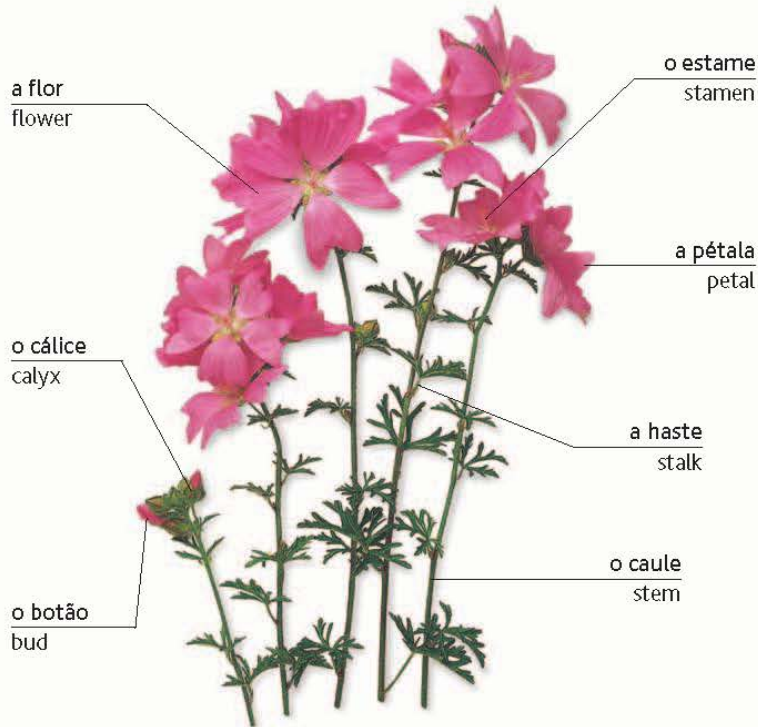

o rainúnculo amarelo
buttercup



a margarida
daisy



o cardo
thistle



o dente-de-leão
dandelion



a urze
heather



a papoila
poppy



a dedaleira
foxglove



a madressilva
honeysuckle



o girassol
sunflower



o trevo
clover



as campainhas
bluebells



a primula
primrose



os lupinos
lupine



a urtiga
nettle

a cidade • town



os edifícios • buildings



a câmara municipal
town hall



a biblioteca
library

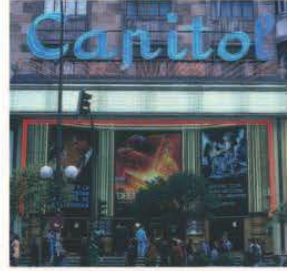

o cinema
movie theater



o teatro
theater



a universidade
university



o arranha-céus
skyscraper



a escola
school

as zonas • areas



a zona industrial
industrial complex



a cidade
city



a periferia
suburb



a aldeia
village

vocabulário • vocabulary

a zona pedonal
pedestrian zone

a rua lateral
side street

a porta de inspeção
manhole

a sarjeta
gutter

a igreja
church

a avenida
avenue

a praça
square

a paragem de autocarro
bus stop

a fábrica
factory

o esgoto
drain

a arquitectura • architecture

os edifícios e as estruturas • buildings and structures



o arranha-céus
skyscraper

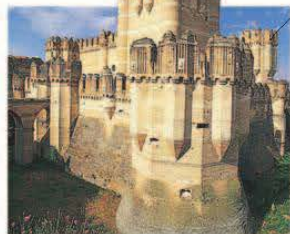

o castelo
castle



a igreja
church

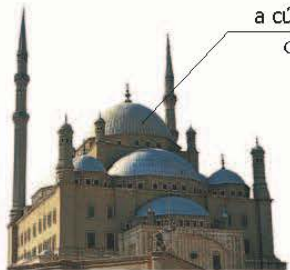

a mesquita
mosque



o templo
temple



a sinagoga
synagogue



a barragem
dam



a ponte
bridge

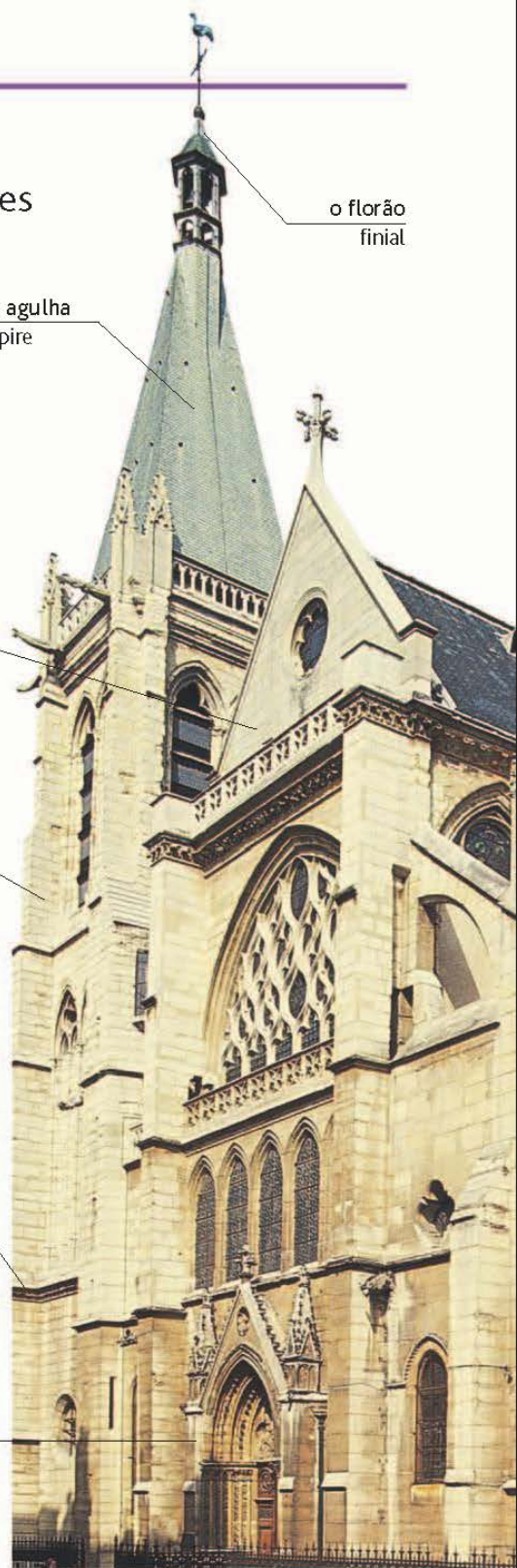

o florão
finial

a torre
turret

a agulha
spire

o fosso
moat

a empena
gable

a cúpula
dome

a torre
tower

a abóbada
vault

a cornija
cornice

a coluna
pillar

a catedral | cathedral

os estilos • styles

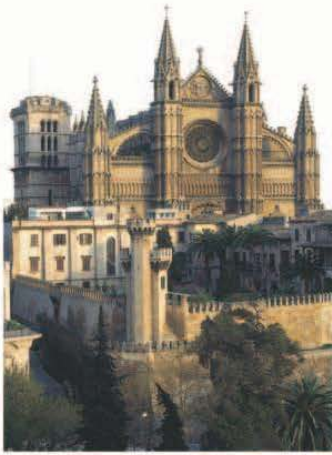

gótico | gothic

a arquitrave
architrave



renascentista
Renaissance



barroco
baroque

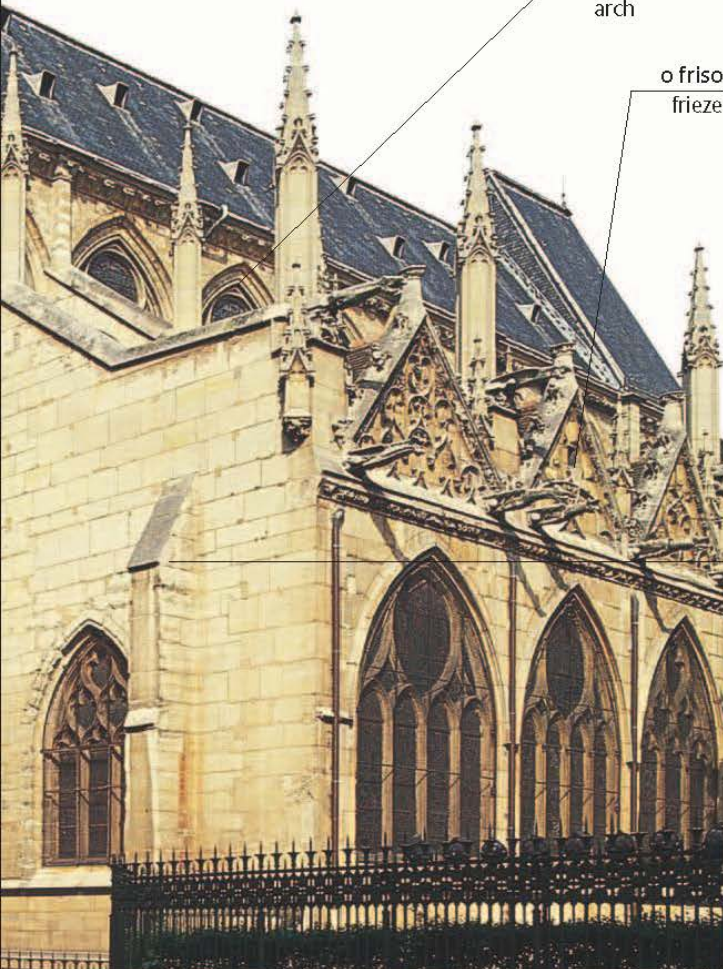

o arco
arch

o friso
frieze

o coro
choir

o frontão
pediment

o contraforte
buttress



rococó
rococo

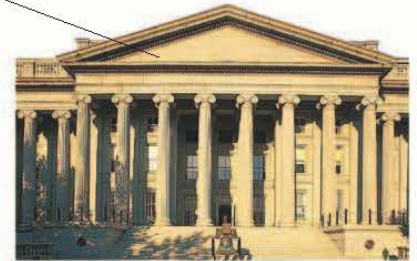

neoclássico
neoclassical

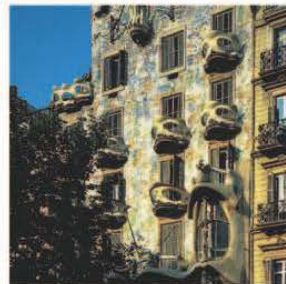

arte nova
art nouveau



arte deco
art deco

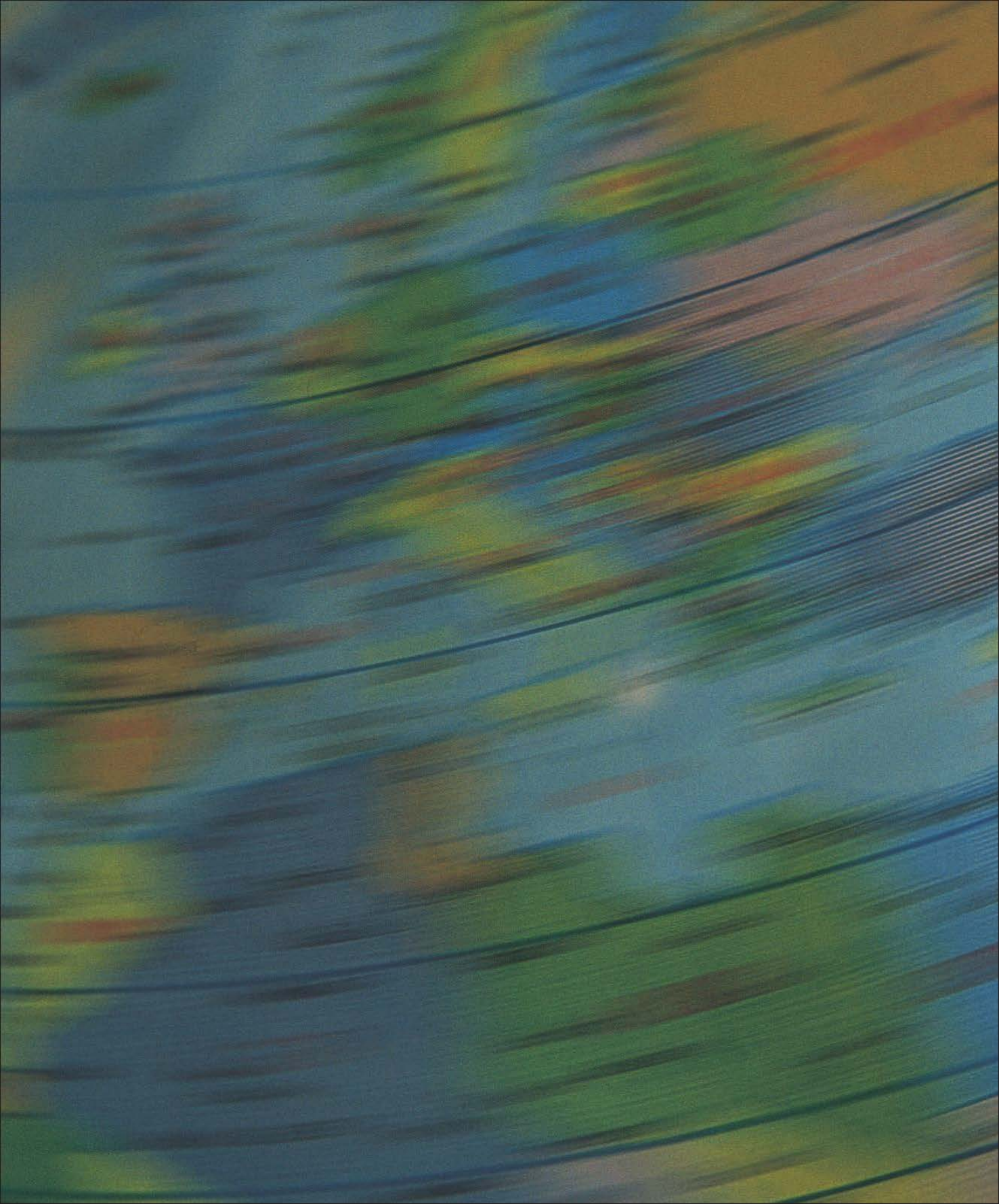

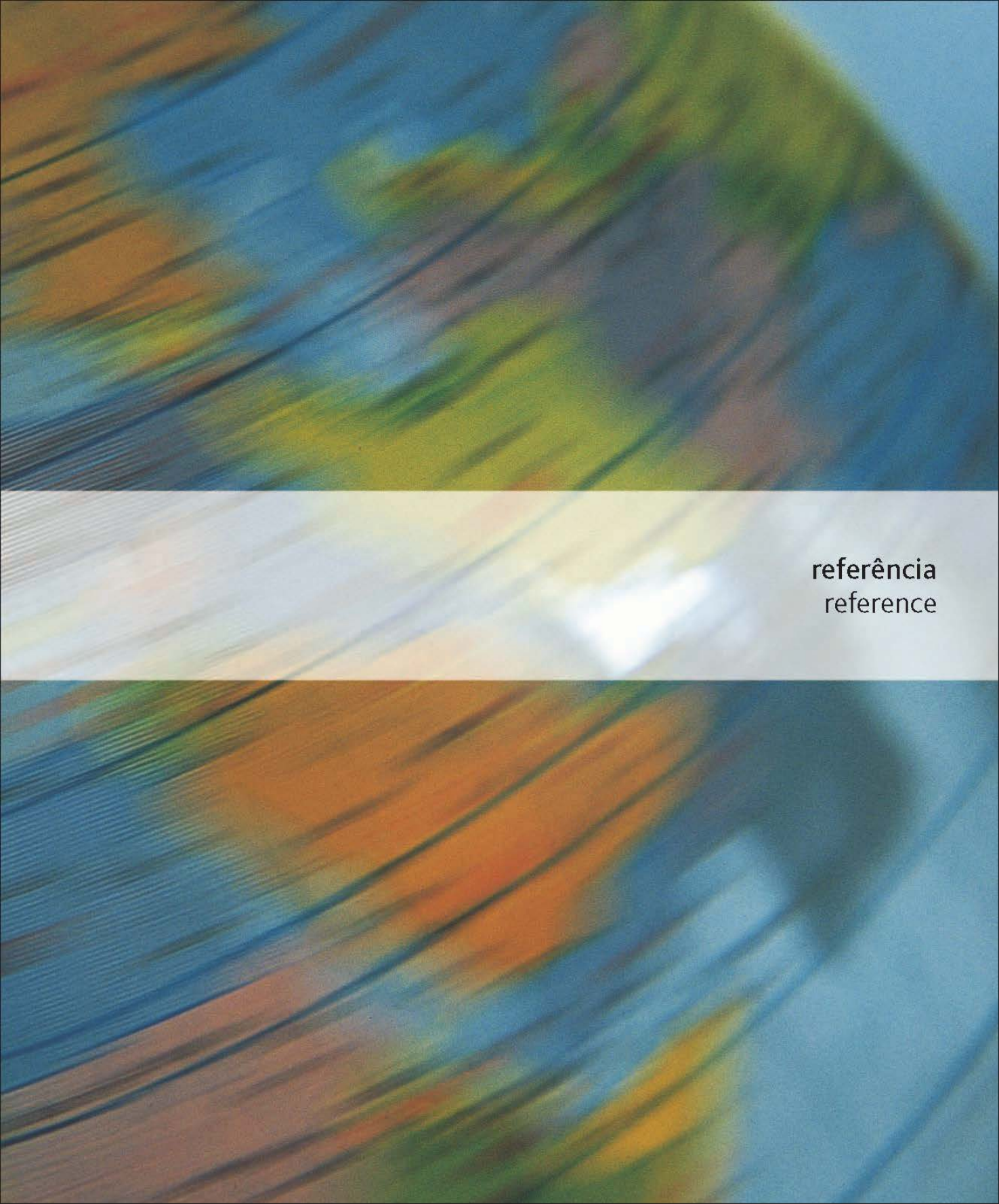

referência
reference

as horas • time

o ponteiro dos minutos
minute hand

o ponteiro das horas
hour hand



o relógio
clock

vocabulário • vocabulary

o segundo second	agora now	um quarto de hora a quarter of an hour
o minuto minute	mais tarde later	vinte minutos twenty minutes
a hora hour	meia hora half an hour	quarenta minutos forty minutes

Que horas são?
What time is it?

São três horas.
It's three o'clock.



uma e cinco
five past one



uma e dez
ten past one



uma e um quarto
quarter past one



uma e vinte
twenty past one



uma e vinte e cinco
twenty five past one

o ponteiro dos segundos
second hand



uma e meia
one thirty



vinte e cinco para as duas
twenty five to two



vinte para as duas
twenty to two



um quarto para as duas
quarter to two



dez para as duas
ten to two



cinco para as duas
five to two



duas horas
two o'clock

a noite e o dia • night and day



a meia-noite | midnight



o nascer do sol | sunrise



a aurora | dawn



a manhã | morning



o pôr-do-sol
sunset

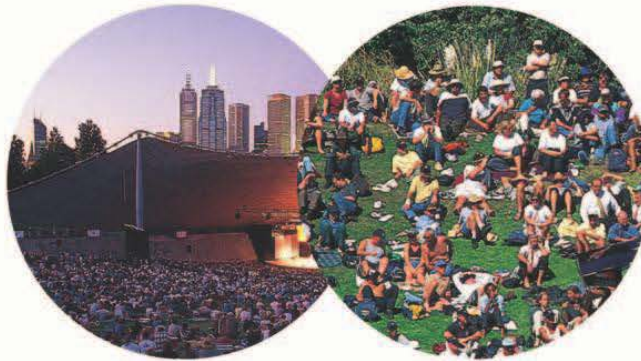

o meio-dia
midday



o anoitecer | dusk



a noite | evening



a tarde | afternoon

vocabulário • vocabulary

cedo
early

Chegaste cedo.
You're early.

Por favor não te atrases.
Please be on time.

A que horas termina?
What time does it finish?

a horas
on time

Estás atrasado.
You're late.

Até logo.
I'll see you later.

Está a ficar tarde.
It's getting late.

atrasado
late

Chegarei daqui a pouco.
I'll be there soon.

A que horas começa?
What time does it start?

Quanto tempo vai durar?
How long will it last?

o calendário • calendar

o mês
month

o ano
year

Janeiro
January

2010



o dia
day

segunda
Monday

terça
Tuesday

quarta
Wednesday

quinta
Thursday

sexta
Friday

sábado
Saturday

domingo
Sunday

o dia útil
work day

1	2	3	4	5	6	7
8	9	10	11	12	13	14
15	16	17	18	19	20	21

a semana
week

a data
date

ontem
yesterday

hoje
today

amanhã
tomorrow

o fim-de-semana
weekend

vocabulário • vocabulary

Janeiro
January

Março
March

Maio
May

Julho
July

Setembro
September

Novembro
November

Fevereiro
February

Abril
April

Junho
June

Agosto
August

Outubro
October

Dezembro
December

os anos • years

1900 mil e novecentos • nineteen hundred

1901 mil novecentos e um • nineteen hundred and one

1910 mil novecentos e dez • nineteen ten

2000 dois mil • two thousand

2001 dois mil e um • two thousand and one

as estações • seasons

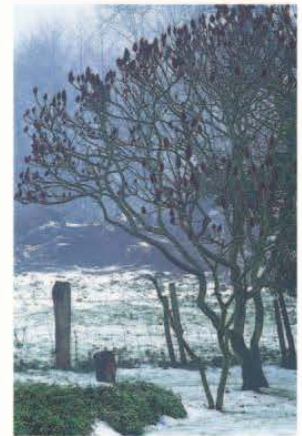
a Primavera
springo Verão
summero Outono
fallo Inverno
winter

vocabulário • vocabulary

o século
centuryesta semana
this weeksemanal
weeklyQue dia é hoje?
What's the date today?a década
decadena semana passada
last weekmensal
monthlyÉ o dia sete de Fevereiro de dois
mil e dois.o milénio
millenniumna próxima semana
next weekanual
annualIt's February seventh, two
thousand and two.a quinzena
two weeksanteontem
the day before yesterdaydepois de amanhã
the day after tomorrow

os números • numbers

0	zero • zero	20	vinte • twenty
1	um • one	21	vinte e um • twenty-one
2	dois • two	22	vinte e dois • twenty-two
3	três • three	30	trinta • thirty
4	quatro • four	40	quarenta • forty
5	cinco • five	50	cinquenta • fifty
6	seis • six	60	sessenta • sixty
7	sete • seven	70	setenta • seventy
8	oito • eight	80	oitenta • eighty
9	nove • nine	90	noventa • ninety
10	dez • ten	100	cem • one hundred
11	onze • eleven	110	cento e dez • one hundred and ten
12	doze • twelve	200	duzentos • two hundred
13	treze • thirteen	300	trezentos • three hundred
14	catorze • fourteen	400	quatrocentos • four hundred
15	quinze • fifteen	500	quinhentos • five hundred
16	dezasseis • sixteen	600	seiscentos • six hundred
17	dezasete • seventeen	700	setecentos • seven hundred
18	dezoito • eighteen	800	oitocentos • eight hundred
19	dezanove • nineteen	900	novecentos • nine hundred

1000	mil • one thousand
10,000	dez mil • ten thousand
20,000	vinte mil • twenty thousand
50,000	cinquenta mil • fifty thousand
55,500	cinquenta e cinco mil e quinhentos • fifty-five thousand five hundred
100,000	cem mil • one hundred thousand
1,000,000	um milhão • one million
1,000,000,000	mil milhões • one billion



primeiro
first

segundo
second

terceiro
third

quarto • fourth

quinto • fifth

sexto • sixth

sétimo • seventh

oitavo • eighth

nono • ninth

décimo • tenth

décimo primeiro • eleventh

décimo segundo • twelfth

décimo terceiro • thirteenth

décimo quarto • fourteenth

décimo quinto • fifteenth

décimo sexto • sixteenth

décimo sétimo •
seventeenth

décimo oitavo • eighteenth

décimo nono • nineteenth

vigésimo • twentieth

vigésimo primeiro •
twenty-first

vigésimo segundo •
twenty-second

vigésimo terceiro •
twenty-third

trigésimo • thirtieth

quadragésimo • fortieth

quingagésimo • fiftieth

sexagésimo • sixtieth

septuagésimo • seventieth

octogésimo • eightieth

nonagésimo • ninetieth

centésimo • one hundredth

os pesos e as medidas • weights and measures

a área • area

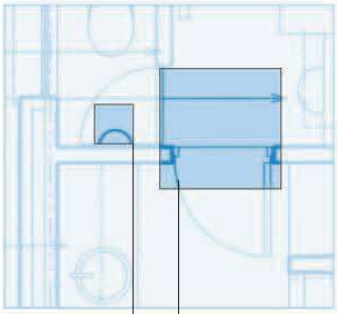

o pé quadrado
square foot

o metro quadrado
square meter

a distância • distance

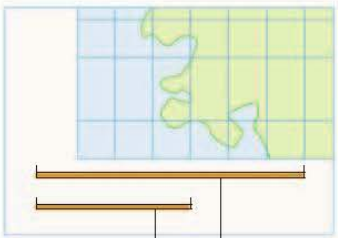

o quilômetro
kilometer

a milha
mile



a libra
pound

a onça
ounce

o prato
pan

o quilograma
kilogram

o grama
gram

a balança | scales

vocabulário • vocabulary

a jarda
yard

a tonelada
ton

medir (v)
measure (v)

o metro
meter

o miligrama
milligram

pesar (v)
weigh (v)

o comprimento • length

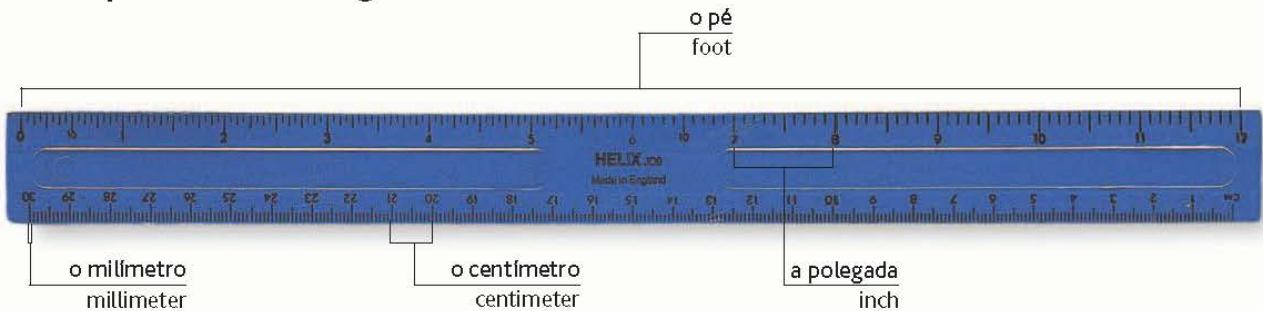

o pé
foot

o milímetro
millimeter

o centímetro
centimeter

a polegada
inch

a capacidade • capacity

o meio litro
half-liter

o pinto
pint

o volume
volume

o mililitro
milliliter



o jarro graduado | measuring cup



a medida para líquidos | liquid measure

vocabulário •
vocabulary

o galão
gallon

o quarto de galão
quart

o litro
liter

o recipiente • container



o pacote
carton



o pacote
packet



a garrafa
bottle



o saco
bag



a caixa | tub



o boião | jar



a lata
can

a lata | can



o pulverizador | liquid dispenser

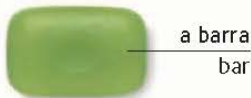

a barra
bar



o tubo
tube



o rolo
roll



o maço
pack



o spray
spray can

o mapa do mundo • world map

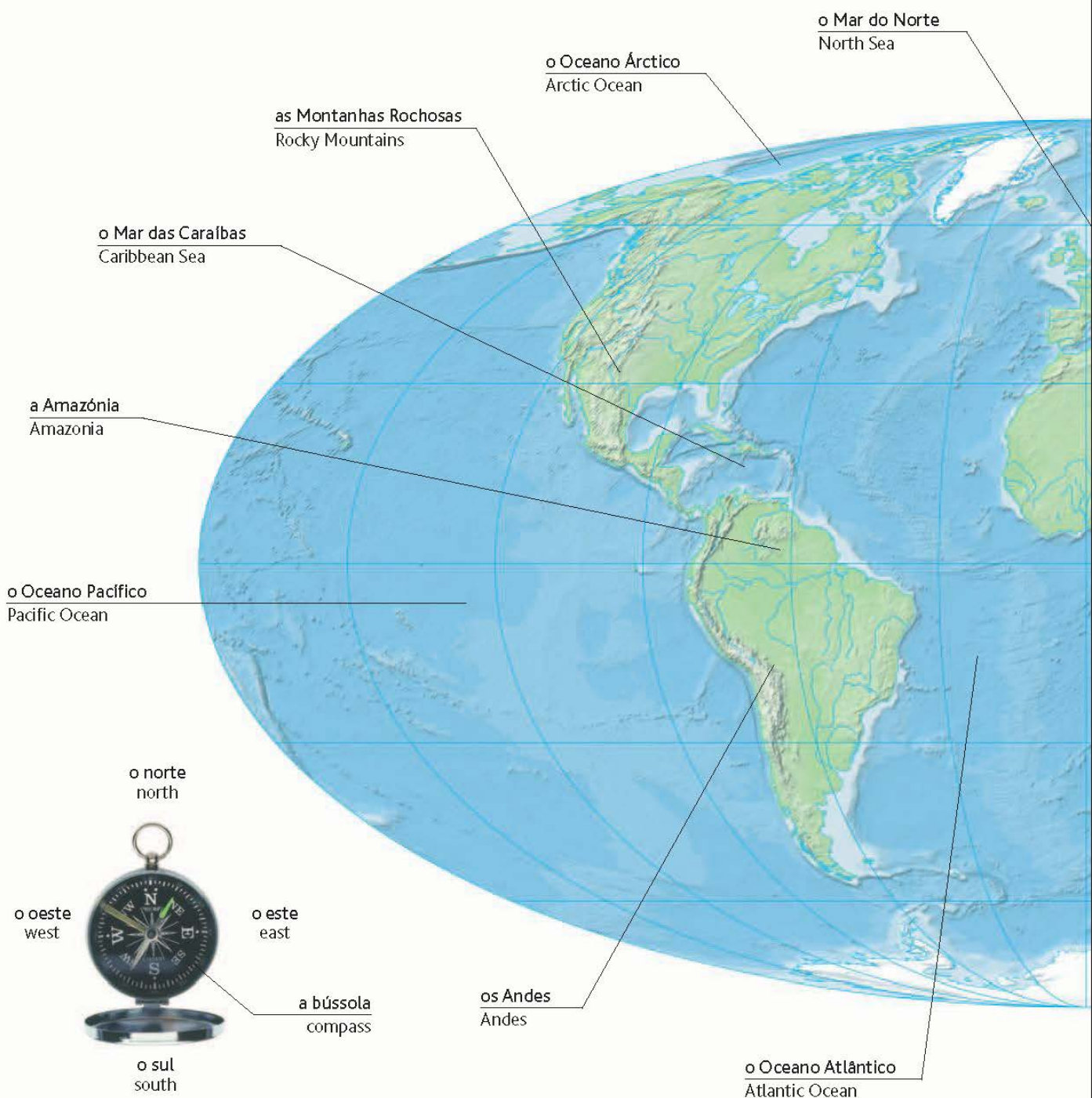

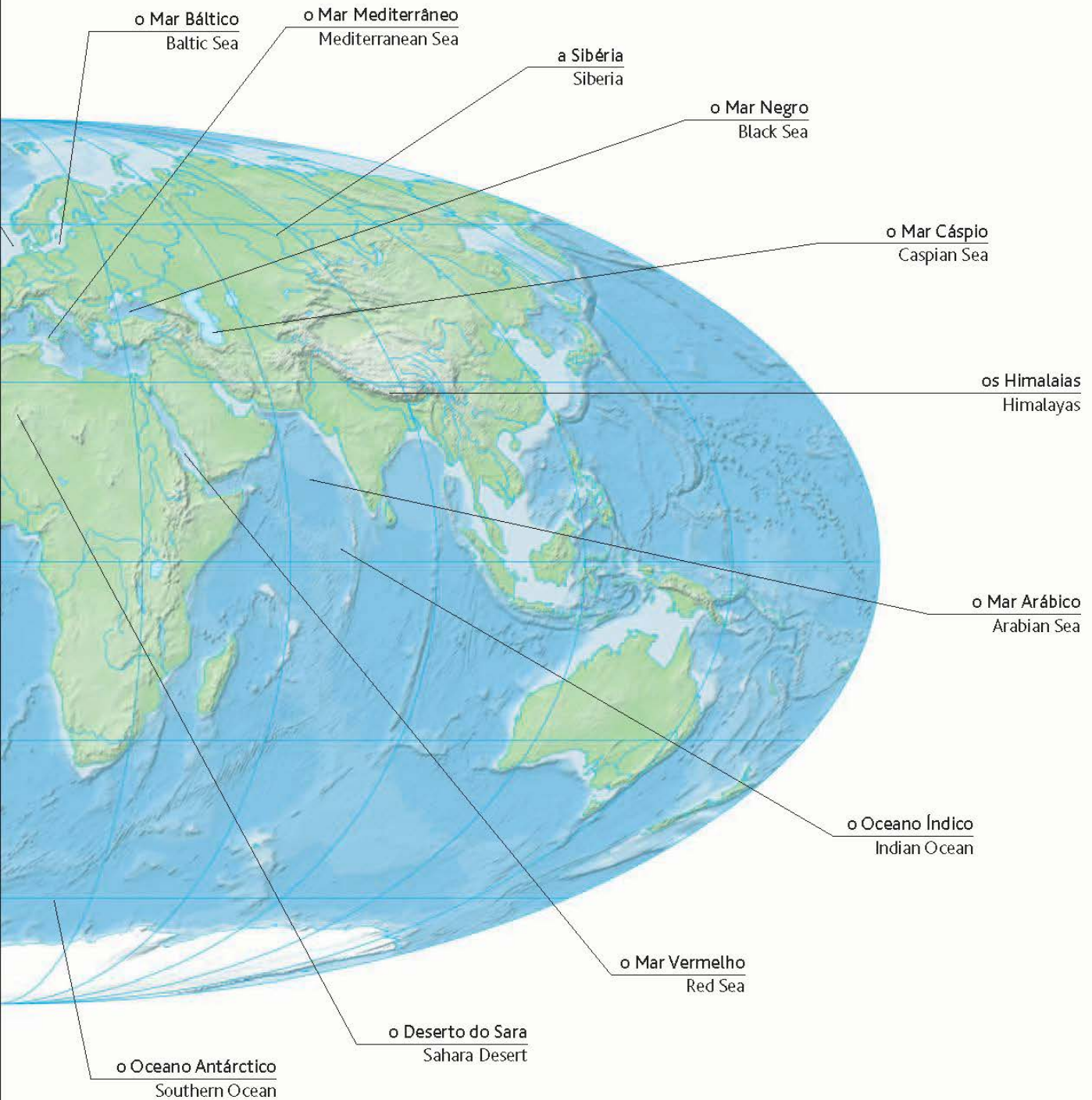

América do Norte e Central • North and Central America

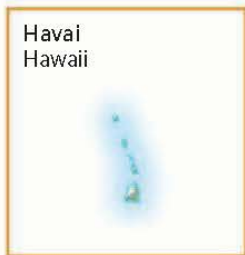

- 1 Alasca • Alaska
- 2 Canadá • Canada
- 3 Gronelândia • Greenland
- 4 Estados Unidos da América
• United States of America
- 5 México • Mexico
- 6 Guatemala • Guatemala
- 7 Belize • Belize
- 8 El Salvador • El Salvador
- 9 Honduras • Honduras
- 10 Nicarágua • Nicaragua
- 11 Costa Rica • Costa Rica
- 12 Panamá • Panama
- 13 Cuba • Cuba
- 14 Baamas • Bahamas
- 15 Jamaica • Jamaica
- 16 Haiti • Haiti
- 17 República Dominicana • Dominican Republic
- 18 Porto Rico • Puerto Rico
- 19 Barbados • Barbados
- 20 Trindade e Tobago • Trinidad and Tobago
- 21 St. Kitts e Nevis • St. Kitts and Nevis
- 22 Antígua e Barbuda • Antigua and Barbuda
- 23 Domínica • Dominica
- 24 Santa Lúcia • St. Lucia
- 25 São Vicente e Granadinas • St. Vincent and The Grenadines
- 26 Granada • Grenada

América do Sul • South America



- 1 Venezuela • Venezuela
- 2 Colômbia • Colombia
- 3 Equador • Ecuador
- 4 Peru • Peru
- 5 Ilhas Galápagos • Galapagos Islands
- 6 Guiana • Guyana
- 7 Suriname • Suriname
- 8 Guiana Francesa • French Guiana
- 9 Brasil • Brazil
- 10 Bolívia • Bolivia
- 11 Chile • Chile
- 12 Argentina • Argentina
- 13 Paraguai • Paraguay
- 14 Uruguai • Uruguay
- 15 Ilhas Malvinas • Falkland Islands

vocabulário • vocabulary

o país country	a província province	a zona zone
a nação nation	o território territory	o distrito district
o estado state	a colônia colony	a região region
o continente continent	o principado principality	a capital capital

Europa • Europe

- | | | |
|---|---------------------------|---|
| 1 Irlanda • Ireland | 32 Malta • Malta | 42 Bósnia-Herzegovina •
Bosnia and Herzegovina |
| 2 Reino Unido • United Kingdom | 33 Eslovénia • Slovenia | 43 Albânia • Albania |
| 3 Portugal • Portugal | 34 Croácia • Croatia | 44 Macedónia • Macedonia |
| 4 Espanha • Spain | 35 Hungria • Hungary | 45 Bulgária • Bulgaria |
| 5 Ilhas Baleares •
Balearic Islands | 36 Eslováquia • Slovakia | 46 Grécia • Greece |
| 6 Andorra • Andorra | 37 Ucrânia • Ukraine | 47 Kosovo (disputado) •
Kosovo (disputed) |
| 7 França • France | 38 Bielorrússia • Belarus | 48 Montenegro • Montenegro |
| 8 Bélgica • Belgium | 39 Moldávia • Moldova | |
| 9 Países Baixos • Netherlands | 40 Roménia • Romania | |
| 10 Luxemburgo • Luxembourg | 41 Sérvia • Serbia | |
| 11 Alemanha • Germany | | |
| 12 Dinamarca • Denmark | | |
| 13 Noruega • Norway | | |
| 14 Suécia • Sweden | | |
| 15 Finlândia • Finland | | |
| 16 Estónia • Estonia | | |
| 17 Látvia • Latvia | | |
| 18 Lituânia • Lithuania | | |
| 19 Kaliningrado • Kaliningrad | | |
| 20 Polónia • Poland | | |
| 21 República Checa •
Czech Republic | | |
| 22 Áustria • Austria | | |
| 23 Liechtenstein •
Liechtenstein | | |
| 24 Suíça • Switzerland | | |
| 25 Itália • Italy | | |
| 26 Mónaco • Monaco | | |
| 27 Córsega • Corsica | | |
| 28 Sardenha • Sardinia | | |
| 29 São Marinho •
San Marino | | |
| 30 Cidade do Vaticano •
Vatican City | | |
| 31 Sicília • Sicily | | |



África • Africa

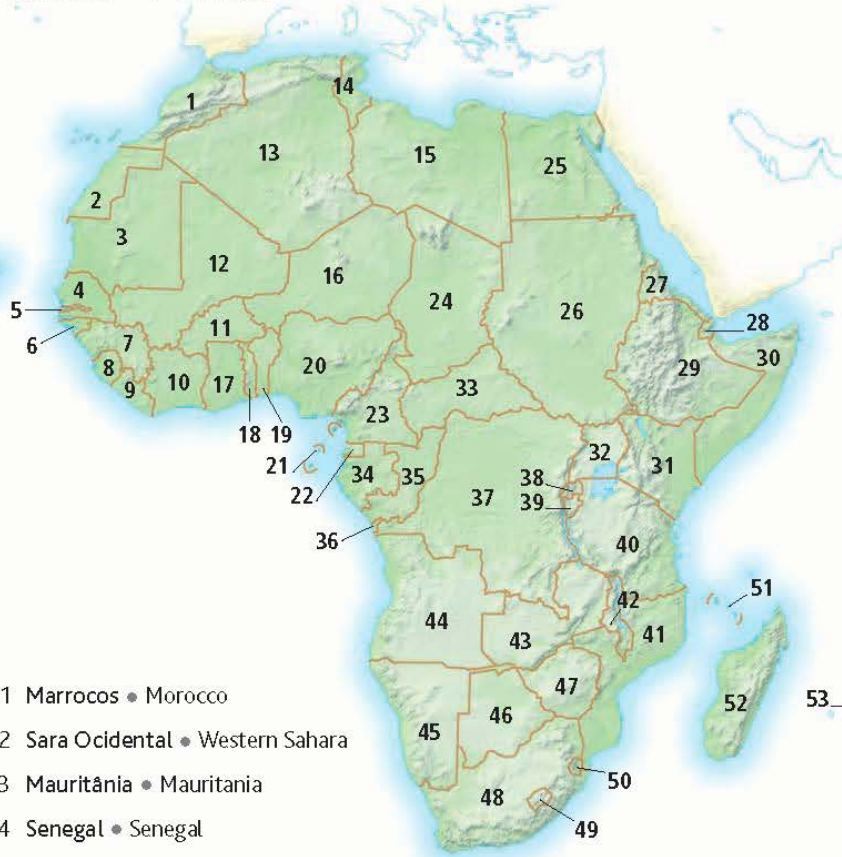

- | | | |
|-----------------------------------|--|--|
| 1 Marrocos • Morocco | | |
| 2 Sara Ocidental • Western Sahara | | |
| 3 Mauritânia • Mauritania | | |
| 4 Senegal • Senegal | | |
| 5 Gâmbia • Gambia | | |
| 6 Guiné-Bissau • Guinea-Bissau | | |
| 7 Guiné • Guinea | | |
| 8 Serra Leoa • Sierra Leone | | |
| 9 Libéria • Liberia | | |
| 10 Costa do Marfim • Ivory Coast | | |
| 11 Burquina Faso • Burkina Faso | | |
| 12 Mali • Mali | | |
| 13 Argélia • Algeria | | |
| 14 Tunísia • Tunisia | | |
| 15 Líbia • Libya | | |
| 16 Níger • Niger | | |
| 17 Gana • Ghana | | |
| 18 Togo • Togo | | |
| 19 Benim • Benin | | |
| | 20 Nigéria • Nigeria | |
| | 21 São Tomé e Príncipe • São Tomé and Príncipe | |
| | 22 Guiné Equatorial • Equatorial Guinea | |
| | 23 Camarões • Cameroon | |
| | 24 Chade • Chad | |
| | 25 Egipto • Egypt | |
| | 26 Sudão • Sudan | |
| | 27 Eritreia • Eritrea | |
| | 28 Djibuti • Djibouti | |
| | 29 Etiópia • Ethiopia | |
| | 30 Somália • Somalia | |
| | 31 Quênia • Kenya | |
| | 32 Uganda • Uganda | |
| | | 33 República Centro-Africana • Central African Republic |
| | | 34 Gabão • Gabon |
| | | 35 Congo • Congo |
| | | 36 Cabinda • Cabinda (Angola) |
| | | 37 República Democrática do Congo • Democratic Republic of the Congo |
| | | 38 Ruanda • Rwanda |
| | | 39 Burundi • Burundi |
| | | 40 Tanzânia • Tanzania |
| | | 41 Moçambique • Mozambique |
| | | 42 Malawi • Malawi |
| | | 43 Zâmbia • Zambia |
| | | 44 Angola • Angola |
| | | 45 Namíbia • Namibia |
| | | 46 Botsuana • Botswana |
| | | 47 Zimbábue • Zimbabwe |
| | | 48 África do Sul • South Africa |
| | | 49 Lesoto • Lesotho |
| | | 50 Suazilândia • Swaziland |
| | | 51 Comores • Comoros |
| | | 52 Madagáscar • Madagascar |
| | | 53 Maurícia • Mauritius |

Ásia • Asia

- 1 Turquia • Turkey
- 2 Chipre • Cyprus
- 3 Federação Russa • Russian Federation
- 4 Geórgia • Georgia
- 5 Arménia • Armenia
- 6 Azerbaijão • Azerbaijan
- 7 Irão • Iran
- 8 Iraque • Iraq
- 9 Síria • Syria
- 10 Líbano • Lebanon
- 11 Israel • Israel
- 12 Jordânia • Jordan
- 13 Arábia Saudita • Saudi Arabia
- 14 Kuwait • Kuwait
- 15 Barém • Bahrain
- 16 Qatar • Qatar
- 17 Emiratos Árabes Unidos • United Arab Emirates
- 18 Omã • Oman
- 19 Iémen • Yemen
- 20 Cazaquistão • Kazakhstan
- 21 Usbequistão • Uzbekistan
- 22 Turquemenistão • Turkmenistan
- 23 Afeganistão • Afghanistan
- 24 Tajiquistão • Tajikistan
- 25 Quirguistão • Kyrgyzstan
- 26 Paquistão • Pakistan
- 27 Índia • India
- 28 Maldivas • Maldives
- 29 Sri Lanka • Sri Lanka
- 30 China • China
- 31 Mongólia • Mongolia
- 32 Coreia do Norte • North Korea
- 33 Coreia do Sul • South Korea



- 34 Japão • Japan
- 35 Nepal • Nepal
- 36 Butão • Bhutan
- 37 Bangladeche • Bangladesh
- 38 Burma (Mianmar) • Burma (Myanmar)
- 39 Tailândia • Thailand
- 40 Laos • Laos

Australásia • Australasia



- 1 Austrália • Australia
- 2 Tasmânia • Tasmania
- 3 Nova Zelândia • New Zealand

- 41 Vietname • Vietnam
- 42 Cambodja • Cambodia
- 43 Malásia • Malaysia
- 44 Singapura • Singapore
- 45 Indonésia • Indonesia
- 46 Brunei • Brunei
- 47 Filipinas • Philippines
- 48 Timor-Leste • East Timor
- 49 Papua-Nova Guiné • Papua New Guinea
- 50 Ilhas Salomão • Solomon Islands
- 51 Vanuatu • Vanuatu
- 52 Fiji • Fiji

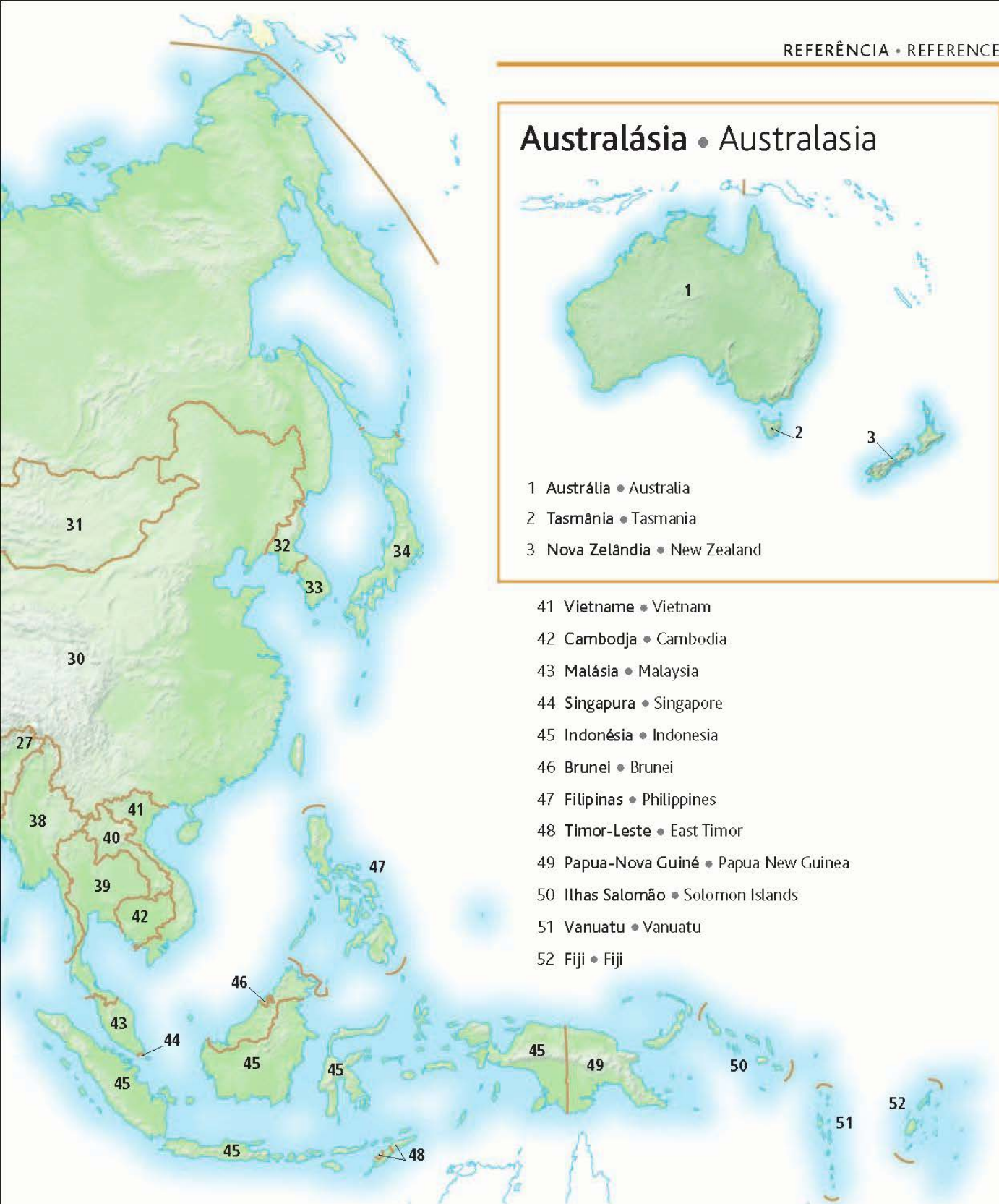

advérbios e antónimos • particles and antonyms

a, para to	de from	para for	para, em direcção a towards
em cima de over	debaixo de under	ao longo de along	através de across
em frente de in front of	atrás de behind	com with	sem without
sobre onto	para dentro de into	antes before	depois de after
em in	fora out	por by	até until
acima above	por baixo, abaixo de below	cedo early	tarde late
dentro inside	fora outside	agora now	mais tarde later
em cima, até up	para baixo, em baixo down	sempre always	nunca never
em at	para além de beyond	frequentemente often	raramente rarely
através de through	cerca de around	ontem yesterday	amanhã tomorrow
por cima on top of	ao lado de beside	primeiro first	último last
entre between	em frente de opposite	cada every	alguns some
perto near	longe far	cerca de about	exactamente exactly
aqui here	ali there	um pouco a little	muito a lot

grande large	pequeno small	quente hot	frio cold
largo wide	estreito narrow	aberto open	fechado closed
alto tall	baixo short	cheio full	vazio empty
alto high	baixo low	novo new	velho old
grosso thick	fino thin	claro light	escuro dark
leve light	pesado heavy	fácil easy	difícil difficult
duro hard	mole soft	livre free	ocupado occupied
úmido wet	seco dry	forte strong	fraco weak
bom good	mau bad	gordo fat	magro thin
rápido fast	lento slow	jovem young	velho old
certo correct	errado wrong	melhor better	piores worse
limpo clean	sujo dirty	preto black	branco white
bonito beautiful	feio ugly	interessante interesting	aborrecido boring
caro expensive	barato cheap	doente sick	bem well
silencioso quiet	barulhento noisy	início beginning	fim end

frases úteis • useful phrases

frases essenciais •
essential phrases

Sim
Yes

Não
No

Talvez
Maybe

Por favor
Please

Obrigado
Thank you

De nada
You're welcome

Com licença
Excuse me

Desculpe
I'm sorry

Não
Don't

OK
OK

Está bem
That's fine

Está certo
That's correct

Está mal/errado
That's wrong

saudações • greetings

Olá
Hello

Adeus
Goodbye

Bom dia
Good morning

Boa tarde
Good afternoon

Boa noite
Good evening

Boa noite
Good night

Como está?
How are you?

Chamo-me...
My name is...

Como se chama?
What is your name?

Como se chama ele/ela?
What is his/her name?

Apresento-lhe...
May I introduce...

Este/Esta é...
This is...

É um prazer conhecê-lo
Pleased to meet you

Até logo
See you later

sinais • signs

A informação turística
Tourist information

Entrada
Entrance

Saída
Exit

Saída de emergência
Emergency exit

Empurrar
Push

Perigo
Danger

Não fumar
No smoking

Avariado
Out of order

Horário de abertura
Opening times

Entrada livre
Free admission

Aberto todo o dia
Open all day

Preço reduzido
Reduced price

Saldos
Sale

Bata antes de entrar
Knock before entering

Proibido pisar a relva
Keep off the grass

ajuda • help

Pode ajudar-me?
Can you help me?

Não compreendo
I don't understand

Não sei
I don't know

Fala inglês, francês...?
Do you speak English,
French...?

Falo inglês, espanhol...
I speak English, Spanish...

Por favor fale mais devagar
Please speak more slowly

Pode-me escrever isso, por favor?
Please write it down for me

Perdi...
I have lost...

indicações • directions

Estou perdido
I am lost

Onde fica o/a...?
Where is the...?

Onde fica o/a... mais
próximo/a?
Where is the nearest...?

Onde ficam as casas de
banho?
Where are the toilets?

Como vou para...?
How do I get to...?

À direita
To the right

À esquerda
To the left

Sempre em frente
Straight ahead

A que distância fica o/a...?
How far is...?

**os sinais de trânsito •
road signs**

Todos os sentidos
All directions

Atenção
Caution

Proibida a entrada
Do not enter

Diminuir a velocidade
Slow down

Desvio
Diversion

Circular pela direita
Keep to the right

Autoestrada
Motorway

Proibido estacionar
No parking

Estrada sem saída
No through road

Rua de sentido único
One-way street

Outras direcções
Other directions

Residentes apenas
Residents only

Obras na estrada
Roadworks

Curva perigosa
Dangerous bend

**alojamento •
accommodation**

Tenho uma reserva
I have a reservation

Onde é a sala de refeições?
Where is the dining room?

O número do meu quarto é
o...
My room number is...

A que horas é o pequeno-
almoço?
What time is breakfast?

Voltarei às... horas
I'll be back at... o'clock

Vou embora amanhã
I'm leaving tomorrow

**comida e bebida •
eating and drinking**

Saúde!
Cheers!

Está delicioso/horrível
It's delicious/awful

Não bebo/fumo
I don't drink/smoke

Não como carne
I don't eat meat

Não quero mais, obrigado
No more for me,
thank you

Posso repetir?
May I have some more?

Pode trazer-nos a conta?
May we have the
bill?

Pode dar-me um recibo?
Can I have a receipt?

Zona de não fumadores
No-smoking area

saúde • health

Não me sinto bem
I don't feel well

Tenho náuseas
I feel sick

Qual é o número de
telefone do médico mais
próximo?
What is the telephone
number of the nearest
doctor?

Dói-me aqui
It hurts here

Tenho febre
I have a temperature

Estou grávida de... meses
I'm... months pregnant

Preciso de uma receita de...
I need a prescription for...

Normalmente tomo...
I normally take...

Sou alérgico a...
I'm allergic to...

Índice português • Portuguese index

- A**
a 320
à la carte 152
aba do telhado f 58
abacate m 128
abaixo de 320
abaixo do par 233
abalado 25
abas de raia f 120
abómen m 12
abdominais m 16
abdominal m 251
abelha f 295
aberto 260, 321
abertura f 256
abóbada f 300
abóbora f 125
abóbora-menina f 124
abóbora-porqueira f 125
aborrecido 25, 321
aborto espontâneo m 52
abre-latas m 68
abrigo da paragem m 197
abrigo dos jogadores m 229
Abril 306
absolvido 181
acácia f 110
academia de dança f 169
açafraão m 132
acampar (v) 266
acções f 227, 229, 233, 237, 245
acções f 97
acelerador m 200, 204
acelga f 123
acendalha f 266
acender uma fogueira (v) 266
acer m 296
acesso para cadeiras de rodas m 197
acessórios m 36, 38
acidente de carro m 203
acidente m 46
ácido 127
acima 320
acima do par 233
aço inoxidável m 79
acolchoado m 277
acompanhamento m 153
acontecimentos da vida m 26
acordar (v) 71
acordo comercial m 175
acta f 174
actividades ao ar livre f 262
actividades f 162, 183, 263
actor m 191, 254
actores m 179
actriz f 254
acupressão f 55
acupunctura f 55
acusação f 94, 180
acusado m 180
adesivo m 47
admissão da água f 61
admissão f 61
adolescente f 23
adornos para o jardim m 84
adubar à superfície (v) 90
adubo m 91
adulto m 23
adversário m 236
advogado m 180, 190
aeróbica f 251
aeroporto m 212
Afeganistão 318
afiador de facas m 68, 118
afinação f 203
afogar-se (v) 239
África 317
África do Sul 317
aftershave m 73
agachamento m 251
agarrar m 237
ágata f 289
agência de viagens f 114
agenda f 175
agenda organiser f 173
agente da polícia m 94
agente de viagens f 190
agente imobiliária f 189
agente imobiliário m 115
agitador m 150
aglomerado m 79
agora 304, 320
Agosto 306
agrafador m 173
agrafos m 173
agressão f 94
agrião m 123
agricultor m 182, 189
água da torneira f 144
água de colónia f 41
água engarrafada f 144
água f 144, 238
água gasosa f 144
água mineral f 144
água tónica f 144
aguaceiro m 286
água-marinha f 288
aguarelas f 274
aguardar f 83
águia f 292
agulha de crochet f 277
agulha de tricô f 277
agulha f 109, 276, 300
aikido m 236
aileron m 210
aipo m 122
aipo-rábano m 124
airbag m 201
ajudante do chefe m 152
alamo m 296
alarme anti-roubo m 58
alarme de incêndio m 95
Alasca 314
alavanca da jante f 207
alavanca de emergência f 209
alavanca de mudanças f 207
alavanca do travão f 207
alavanca f 61, 150
Albânia 316
álbum de fotografias m 271
alça do pedal f 207
alça f 35
alça para ombro f 37
alça reflectora f 205
alcaçofra f 124, 125
alcaçuz m 113
alcaparras f 143
alcaravia f 131
alcatifa f 71
alcatrão m 187
alcofa f 74, 75
aldeia f 299
alegação do arguido f 180
Alemanha 316
alergia f 44
alface f 123
alfafa f 184
alfaiate m 115, 191
alfândega f 212, 216
alfinete de gravata m 36
alfinete de segurança m 47
alfinete m 173, 276
alforreca f 295
algemas f 94
algoroz m 58
algodão m 184, 277
alguns 320
alho francês m 125
alho m 125, 132
ali 320
alicate corta-arames m 81
alicate de bico fino m 80
alicate m 80
alimentos engarrafados m 134
alimentos m 117
alinhavar (v) 277
alisar (v) 39
aljava f 249
almoço de negócios m 175
almoço m 64
almofada de alfinetes f 276
almofada de ombro 35
almofada de tinta f 173
almofada do antepé f 15
almofada f 62, 70
almofariz m 68, 167
alongamento m 251
alongar (v) 251
alpendre m 182
alperce m 126
alquequenje m 128
alternador m 203
altifalante m 176
altitude f 211
alto 321
altura f 165
aluguer de carros m 213
alumínio m 289
aluna f 162
aluno m 162
alvo m 249, 273
amaciador de roupa m 76
amaciador m 38
amamentação f 53
amamentar (v) 53
amanhã 306, 320
amarelo 274
amargo 124
amarrar (v) 217
amassar (v) 138
Amazônia f 312
ambiente m 279
ambulância f 94
amêijoia f 121
ameixa f 126
ameixa seca f 129
amêndoa f 122, 129
amêndoas f 151
amendoim m 129
amendoins m 151
América do Norte e Central 314
América do Sul 315
ametista f 288
amigo m 24
amniocentese f 52
amora f 127
ampere m 60
ampliação f 58, 271
ampliar (v) 172
amplificador m 268
analgésico m 109
analgésicos m 47
análise de sangue f 48
análise f 49
ananás m 128
anca f 12
andino m 88
âncora f 214, 240
ancoragem f 217
andaime m 186
andar de bicicleta (v) 207
andar de skate 249, 263
andar de trenó 247
Andes m 312
andorinha f 292
Andorra 316
anel m 36
anestésista f 48
anexo m 177
anfíbios m 294
anfiteatro m 169
anfritriã f 64
anfritrião m 64
Angola 317
ângulo m 164
anil 274
anilha f 80
anilhas f 89
animais m 290, 292, 294
anis estrelado m 133
aniversário m 26, 27
ano m 163, 306
Ano Novo m 27
anoitecer m 305
anoraque m 31, 33
anos m 307
antebraço m 12
antecedentes criminais m 181
antena de rádio f 214
antena f 295
antena parabólica f 269
anteontem 307
antes 320
antiaderente 69
anti-congelante m 199
Antígua e Barbuda 314
anti-inflamatório m 109
anti-rugas m 41
anti-séptico m 47
anual 86, 307
anúncio m 269
anzol m 244
ao lado de 320
ao longo de 320
ao vapor 159
apaixonar-se (v) 26
apanha-bolas m 231
apanhador m 229
apanhar (v) 220, 227, 229, 245
apanhar com a rede (v) 245
apara-lápis m 163
aparar (v) 39
aparas de madeira f 78
aparelhagem de alta fidelidade f 268
aparelho ortodôntico m 50
aparelhos eléctricos m 105
aparência f 29
apartamento m 59
apêndice m 18
apertivo m 153
aperitivos m 151
aplaudir (v) 255
aplicação f 176
aplique m 62
apoio do braço m 200
apoio para a cabeça m 200
aposta f 273
aprender (v) 163
apresentação f 174
apresentador m 178, 191
apresentadora do telejornal

- f 179
aquecedor m 60
aquecer (v) 251
aqui 320
ar condicionado m 200
Arábia Saudita 318
arame m 79
aranha f 295
árbitro m 222, 225, 226, 227, 229, 230
arbusto que dá flores m 87
arco m 85, 164, 249, 301
arco plantar m 15
arco-íris m 287
ardósia f 288
área de fumadores f 152
área de não fumadores f 152
área de tráfego f 212
área f 165, 310
areia f 85, 264
arejar (v) 92
arejar a relva (v) 90
arena f 243
arenito m 288
arenques fumados m 157
argamassa f 187
Argélia 317
Argentina 315
argila f 85, 275
argola de guardanapo f 65
argolas f 235
arinca f 120
aritmética f 165
armação f 51
armário de arquivo m 172
armário de medicamentos m 72
armário m 62, 66
armazém m 216
Arménia 318
aro m 226
aromaterapia f 55
arquitecto m 190
arquitectura f 300
arquitrave f 301
arquivador em concertina m 173
arrancar (v) 82
arranha-céus m 299, 300
arranhão m 46
arranjos m 111
arremessar (v) 227
arrendar (v) 58
arroz branco m 130
arroz doce m 140
arroz integral m 130
arroz m 130, 158, 184
arroz para doce m 130
arroz selvagem m 130
arrumador m 255
arte deco 301
arte f 162
arte nova 301
artéria f 19
artes manuais f 274, 276
artes marciais f 237
articulação f 17
artigos de escritório m 105
artigos de higiene pessoal m 107
artigos de toilette m 41
artigos desportivos m 105
artigos para bebé m 107
artista f 274
árvore f 86, 296
as caneleiras 220
as casas de banho f 266
às m 230, 273
as terapias alternativas f 54
asa delta f 248
asa f 119, 210, 293
asas f 37
Ásia 318
asma f 44
aspersor m 89
aspirador m 77, 188
assado m 158
assalto m 94, 237
assar (v) 67
assento m 204, 210, 242
assento traseiro m 204
assessora financeira f 97
assessoria jurídica f 180
assinatura f 96, 98
assistente de bordo f 210
assustado 25
asteróide m 280
astigmatismo m 51
astronauta m 281
astronomia f 281
atacador m 37
ataque de mão aberta m 237
ataque m 220, 237
até 320
atender (v) 99
aterrar (v) 211
atilhos de arame m 89
atirar (v) 221, 223
atleta f 234
atletismo m 234
atmosfera f 282, 286
atracar (v) 217
atração turística f 260
atrações f 261
atrás de 320
atrasado 305
através de 320
atrelado m 266
átrio da estação m 209
átrio m 104
atum m 120
aula f 163
auricular m 99
aurora f 286, 305
auscultador m 99
auscultadores m 268
Australásia 319
Austrália 319
Áustria 316
autocarro de dois pisos m 196
autocarro de ligação m 197
autocarro eléctrico m 196
autocarro escolar m 196
autocarro m 196
autocarro turístico m 197, 260
auto-estrada f 194
automático 200
automobilismo m 249
auxiliar f 24
avalanche f 247
avançado m 222
avanço rápido m 269
avaria f 203
AVC m 44
aveia f 130
avelã f 129
avenida f 299
avental m 50, 69
aves f 292
avestruz f 292
avião de linha m 212
avião de passageiros m 210
avião m 210
avião supersónico m 211
avioneta f 211
avó f 22
avô m 22
avós m 23
axila f 13
axofone m 257
ayurveda f 55
azedra f 123
azeite m 134
azeitona preta f 143
azeitona recheada f 143
azeitona verde f 143
azeitonas f 151
Azerbaijão 318
azeviche m 288
azevicho m 296
azul 274
- B**
Baamas 314
babeiro m 30
babeite com bolso m 30
babygrow m 30
bacalhau m 120
bacia f 50, 72
bacio m 74
backswing m 233
baço m 18
bacon m 118, 157
badejo m 120
badminton m 231
baga f 296
bagageira f 198
bagagem de mão f 211
bagagem de mão f 213
bagagem f 100, 198, 213
bagas e os melões f 127
bagel m 139
baguete f 138
baulado m 255
bailarina f 191
bainha f 34
baixo 321
baixo m 258
balança de mola f 166
balança f 45, 53, 69, 98, 118, 166, 310
balancé m 263
balão de ar quente m 211
balão de ensaio m 166
balaústre m 59
balcão de check-in m 213
balcão de empréstimos m 168
balcão de sanduíches m 143
balcão m 96, 98, 100, 142, 150, 254
balde de gelo m 150
balde m 77, 82, 265
baleia f 290
baliza f 221, 222, 223, 224
baloços m 263
balsa de salvamento f 240
bambu m 86, 122
banana f 39, 128
bancada de trabalho f 78
bancada do júri f 180
bancada f 66
banco de bar m 150
banco m 96, 250, 262
banco traseiro m 200
banda de rodagem f 207
banda sonora f 255
bandeira f 221, 232
bandeiriola de canto f 223
bandeira dobrável f 210
bandeja do pequeno-almoço f 101
bandolete f 38
bangaló m 58
Bangladeche 318
banheira do bebé f 74
banheira f 72
baptizado m 26
bar m 150, 152
bar mitzvah m 26
baralhar (v) 273
baralho m 273
barata f 295
barato 321
barba f 73
Barbados 314
barbatana dorsal f 294
barbatana f 239, 290
barbatana peitoral f 294
barbeiro m 39, 188
bárbula f 244
barco a remos m 214
barco à vela m 215
barco de pesca m 217
barco salva-vidas insuflável m 215
barra de deslocamento f 177
barra de ferramentas f 177
barra de pesos f 251
barra do menu f 177
barra f 235, 250, 256, 311
barra horizontal f 235
barra transversal f 207, 222
barraca f 85
barragem f 300
barras f 74
barreira f 243
barreira de acesso f 209
barreira de segurança f 195, 246
barreira f 222
barriga da perna f 13, 16
barrita de snack f 113
barroco 301
barulhento 321
basalto m 288
base de copos f 150
base f 40, 99, 164, 228
base isolante f 267
base principal f 228
basebol m 228
basílico m 133
basquetebol m 226
bastão m 235, 246
bastidores m 254
bata f 38
batata doce f 125
batata f 124
batata nova f 124
batatas fritas de pacote f 113
batatas fritas f 151, 154
batedor de arames m 68
batedor m 225, 228
batente m 59
bater (v) 224, 225, 227, 229
bater recorde (v) 234
bateria f 78, 202, 258
baterista m 258
batido de café m 149
batido de chocolate m 149
batido de leite m 137
batido de morango m 149
báton m 40
batuta f 256
baunilha f 132
bebé m 23, 30
bebida maltada f 144
bebidas alcoólicas f 145
bebidas f 107, 144, 156
bebidas quentes f 144
beleza f 40
Bélgica 316
Belize 314
bem 321
bermol 256
Benim 317
berbequim eléctrico m 78
berbequim manual m 78, 81
berbequim recarregável m 78
berbigão m 121
berço m 74
beringela f 125
berlina f 199
berma do passeio f 298
berma pavimentada f 194
beterraba f 125
betoneira f 186
bétula f 296

- betumar (v) 82
 betume m 83
 bexiga f 20
 biatlo m 247
 biberão m 75
 biblioteca f 168, 299
 bibliotecária f 168
 bibliotecário m 190
 bica f 148
 biceps m 16
 bicideta de corridas f 206
 bicideta de estrada f 206
 bicideta de montanha f 206
 bicideta de passeio f 206
 bicideta elíptica f 250
 bicideta f 206
 bicideta fixa f 250
 bico de Bunsen m 166
 bico m 163, 293
 bidé m 72
 Bielorrússia 316
 bienal 86
 bife da alcatra m 119
 bife do lombo m 119
 bigode m 290
 bilhar americano m 249
 bilhete de autocarro m 197
 bilhete m 209, 213
 bilhete postal m 112
 bilheteira f 209, 216, 255
 bilhetes da lotaria m 112
 bilro m 277
 binóculo m 281
 biologia f 162
 biológico 118, 122
 biombo m 63
 biplano m 211
 biquini m 264
 bis m 255
 biscoitos de champanhe m 141
 bispo m 272
 bisturi m 167
 blazer m 33
 bloco de apartamentos m 59, 173
 bloco de betão m 187
 bloco de desenho m 275
 bloco de partida m 234, 238
 bloquear (v) 227
 bloquiteo m 237
 blues m 259
 blusa f 34
 blusão corta-vento m 33
 blush m 40
 bobina f 276
 bobsleigh m 247
 boca f 14
 boca-de-incêndio f 95
 bocejar (v) 25
 body m 30
 bóia de salvação f 240
 bóia f 217, 265
 boião hermético m 135
 boião m 134, 311
 bola de bowling f 249
 bola de críquete f 225
 bola de futebol f 220
 bola de golfe f 233
 bola de praia f 265
 bola f 75, 149, 221, 222, 224, 226, 228, 230
 bolacha f 113
 bolachas crocantes f 156
 bolachas f 141
 bolas de algodão f 41
 bolas de carne f 158
 bolbo m 86
 bolha f 46
 Bolívia 315
 bolo de aniversário m 141
 bolo de casamento m 141
 bolo de chocolate m 140
 bolo de frutas m 140
 bolos e as sobremesas m 140
 bolos m 140
 bolos para celebrações m 141
 bolsa de estudos f 169
 bolsa de valores f 97
 bolsa f 291
 bolso m 32
 bom 321
 bomba de ar f 199
 bomba de gasolina f 199
 bomba de leite materno f 53
 bomba f 207
 bombardeiro m 211
 bombeiro m 189
 bombeiros m 95
 boné de montar m 242
 boné m 36
 boneca f 75
 bongos m 257
 bonito 321
 boquilha f 89
 borboleta f 295
 bordado m 277
 borracha f 163
 Bósnia-Herzegovina 316
 bosque m 285
 bota de caminhada f 37
 bota de equitação f 242
 bota de esqui f 246
 bota f 220, 223
 botão da abertura do diafragma m 270
 botão de ajuste m 167
 botão de alamar m 31
 botão de chamada m 48
 botão de paragem m 197
 botão de punho m 36
 botão de velocidade m 270
 botão m 32, 297
 botas de água f 244
 botas de borracha f 31, 89
 botas de trekking f 267
 bote salva-vidas m 214
 botinhas f 30
 Botsuana 317
 boutique f 115
 bowling m 249
 boxercise m 251
 boxers m 33
 braçada f 239
 braçadeira f 238
 braçadeira f 45
 braço m 13, 258
 branco 39, 145, 272, 274, 321
 brandy m 145
 Brasil 315
 brida f 242
 bridge m 273
 brie m 142
 brilhante 271
 brilho para lábios m 40
 brinco m 36
 brinquedo m 75
 brinquedos m 105
 brioche m 157
 britadeira f 187
 broca f 50, 78
 broca para alvenaria f 80
 broca para madeira f 80
 broca para metal f 80
 brocas f 80
 brocas para madeira f 80
 broche m 36
 brochura f 212
 brócolos m 123
 bronze 235
 bronzeado m 41
 bruços 239
 Brunei 319
 buffet do pequeno-almoço m 156
 buffet m 152
 bujarrona f 240
 bule m 65
 Bulgária 316
 bungee-jumping m 248
 bunker m 232
 buquê m 111
 buraco com uma tacada m 233
 buraco m 232
 buraco negro m 280
 Burma (Mianmar) 318
 Burquina Faso 317
 burro m 185
 Burundi 317
 bússola f 240, 312
 Butão 318
 buzina f 201, 204
 C
 cabaça f 125
 cabeça de cilindro f 202
 cabeça do chuveiro f 72
 cabeça f 12, 19, 80, 230
 cabecear (v) 222
 cabeceira f 70
 cabeço m 214
 cabeleira f 39
 cabeleireira f 38
 cabeleireiro m 115, 188
 cabelo m 14, 38
 cabide m 70
 cabina da portagem f 194
 cabina do maquinista f 208
 cabina f 95, 210
 cabina telefónica f 99
 cabinas de prova f 104
 Cabinda 317
 cabo de alimentação m 176
 cabo m 36, 79, 187, 207
 cabos m 60
 cabra f 185
 cabrestante m 214
 cabresto m 243
 cabrito m 185
 caça m 211
 caçarola de barro f 69
 caçarola f 69
 cacau em pó m 148
 cachecol m 31
 cachimbo m 112
 cachorro m 290
 cachorro quente m 155
 cacifo m 100
 cacifos m 239
 cacto m 87
 cada 320
 caddie m 233
 cadeado m 207
 cadeia de montanhas f 282
 cadeira da papa f 75
 cadeira de rodas f 48
 cadeira do dentista f 50
 cadeira f 64
 cadeira giratória f 172
 cadeira para criança f 207
 cadeira para crianças f 198
 cadeirinha f 75
 caderno m 163, 172
 cadinho m 166
 café com gelo m 148
 café com leite m 148
 café com mesas fora m 148
 café de esplanada m 148
 café de filtro m 148
 café m 144, 148, 153, 156, 184, 262
 café moído m 144
 cafeteira f 65
 calaque m 241
 câibra f 239
 cais m 216
 caixa automático m 97
 caixa das ferramentas f 80
 caixa de areia f 263
 caixa de arquivo f 173
 caixa de chocolates f 113
 caixa de correio f 99
 caixa de corte a 45º 81
 caixa de fusíveis f 203
 caixa de lenços de papel f 70
 caixa de material f 244
 caixa de Petri f 166
 caixa de pó compacto f 40
 caixa de primeiros socorros f 47
 caixa de velocidades f 202, 204
 caixa do correio f 58
 caixa dos fusíveis f 60
 caixa dos legumes f 67
 caixa f 106, 150, 311
 caixa m 96, 106
 caixa registadora f 106
 caixa torácica f 17
 caixote de reciclagem m 61
 caixote do lixo m 61, 67
 caju m 129
 caju m 151
 calcanhar m 13, 15
 calças de equitação f 242
 calças de ganga f 31
 calças de treino f 33
 calças f 32, 34
 cálcio m 109
 calcite f 289
 calço de travão m 207
 calções m 30, 33
 calculadora f 165
 caldeira f 61
 calendário m 306
 cálice m 297
 cama de bronzamento f 41
 cama de campismo f 266
 cama de casal f 71
 cama de rede f 266
 cama de solteiro f 71
 cama f 70
 camada de baixo f 141
 camada de cima f 141
 camada de ozono f 286
 camada superior f 85
 câmara APS f 270
 câmara de vídeo f 260, 269
 câmara descartável f 270
 câmara digital f 270
 câmara escura f 271
 câmara f 178, 283
 câmara municipal f 299
 câmara Polaroid f 270
 câmara SLR f 270
 câmara-de-ar f 207
 câmara real m 121
 Camarões 317
 camarote m 214, 254
 Cambodja 318
 cambembert m 142
 camião basculante m 187
 camião dos bombeiros m 95
 camião m 194
 caminho equestre m 263
 caminho m 58, 85
 caminho para pedões m 262
 camioneta de passageiros f 196
 camionista m 190
 camisa de noite f 31, 35
 camisa f 32
 camisola de alças f 35
 camisola de lã f 33
 camisola interior f 33
 camisola interior f 35
 campanha f 59, 197
 campanhas f 297
 campari m 145
 campeonato m 230

- campismo m 266
 campo de críquete m 225
 campo de desportos m 168
 campo de futebol m 220, 222
 campo de golfe m 232
 campo de rãgubi m 221
 campo exterior central m 228
 campo exterior esquerdo m 228
 campo exterior direito m 229
 campo interior m 228
 campo exterior m 229
 campo m 182, 226, 227, 228, 230
 campus m 168
 cana de pesca f 244
 cana do leme f 240
 cana f 91
 Canadá 314
 cana-de-açúcar f 184
 canal deferente m 21
 canal ejaculatório m 21
 canal m 178
 canal pay-per-view m 269
 canalização f 61
 canalizador m 188
 canário m 292
 canas f 89
 canção f 259
 candeeiro de mesa-de-cabeceira m 70
 candeeiro m 62
 cane de porco f 118
 caneca f 65, 75
 canela f 12, 133
 caneleira f 225
 caneta f 163
 canguru m 291
 canino m 50
 canivete m 121
 cano de escoamento m 72
 canoa f 214
 canoagem f 241
 canteiro de flores m 85, 90
 canteiro de plantas herbáceas m 85
 cantil m 267
 canto m 223
 cantora f 191
 cão m 290
 capacete m 95, 186, 204, 206, 220, 228
 capacho m 59
 capacidade f 311
 capitais próprios m 97
 capital f 315
 capitão do porto m 217
 capitão m 214
 capô m 198
 capoeira f 237
 capota f 75
 cappuccino m 148
 cápsula cervical f 21
 cápsula f 109
 capuz m 31
 cara f 14
 caracol m 295
 carambola f 128
 caramelo m 113
 caranguejo m 121, 295
 carapaça f 293
 caravana f 266
 cardamomo m 132
 cardiologia f 49
 cardiovascular 19
 cardo m 297
 careca 39
 carga f 216
 cãrie f 50
 caril m 158
 carimbo de borracha m 173
 carimbo postal m 98
 Carnaval m 27
 carne branca f 118
 carne de aves f 119
 carne de borrego f 118
 carne de caça f 119
 carne de vaca f 118
 carne de veado f 118
 carne de vitela f 118
 carne e as aves f 107
 carne f 118
 carne fresca f 142
 carne magra f 118
 carne picada f 119
 carne vermelha f 118
 carnes frias f 118, 143
 caro 321
 carpa koi f 294
 carpinteiro m 188
 carregadeira f 240
 carretel da linha m 276
 carreto m 244
 carril electricificado m 209
 carril m 208
 carrinha f 199
 carrinho das sobremesas m 152
 carrinho de golfe m 233
 carrinho de mão m 88
 carrinho m 75, 100, 106, 208, 213
 carro da polícia m 94
 carro de cinco portas m 199
 carro de época m 199
 carro de golfe m 232
 carro descapotável m 199
 carro desportivo m 199
 carro m 198, 200, 202
 carroçaria f 202
 carruagem f 208
 carta de vinhos f 152
 carta f 98
 cartão amarelo m 223
 cartão da biblioteca m 168
 cartão de crédito m 96
 cartão de débito m 96
 cartão de embarque m 213
 cartão m 27
 cartão prensado m 79
 cartão vermelho m 223
 cartas f 273
 cartaz m 255
 carteira de homem f 37
 carteira de senhora f 37
 carteira f 97
 carteiro m 98, 190
 cartilagem f 17
 cartão m 296
 carvão m 266, 275, 288
 casa da quinta f 182
 casa das máquinas f 214
 casa de banho f 72
 casa de banho privativa f 100
 casa de bonecas f 75
 casa de brincar f 75
 casa f 32, 58, 272
 casaco de baeta m 31
 casaco de malha m 32
 casaco desportivo m 33
 casaco m 32, 34
 casal comprometido m 24
 casal m 24
 casamento m 26, 35
 casar (v) 26
 casas de banho f 104
 casca f 126, 127, 128, 129, 130, 136, 137, 142, 296
 casco m 214, 240, 242, 291
 casino m 261
 caspa f 39
 casquilho de baioneta m 60
 cassete de vídeo f 269
 cassete f 269
 cassetete m 94
 castanha f 129
 castanha-de-água f 124
 castanha-do-pará f 129
 castanho 39, 274
 castelo de areia m 265
 castelo m 300
 casual 34
 casulo m 295
 catálogo m 168
 catamará m 215
 catarata f 51
 catatua f 293
 catedral f 300
 catéter m 53
 catorze 308
 caução f 181
 cauda f 35, 121, 210, 242, 280, 290, 294
 caule m 122, 297
 cavala f 120
 cavaleiro m 242
 cavalete m 174, 258, 274
 cavalo com arções m 235
 cavalo de corridas m 243
 cavalo m 185, 235, 242, 272
 cavalo marinho m 294
 cavar (v) 90
 cave f 58
 caverna f 284
 Cazaquistão 318
 cebola f 124
 cebolinha f 133
 cebolinho m 125
 cedo 305, 320
 cedro m 296
 cegonha f 292
 ceifeira-debulhadora f 182
 cela da polícia f 94
 cela f 181
 celebração f 140
 celebrações f 27
 celeiro m 182
 cem 308
 cem mil 309
 cenário m 254
 cenoura f 124
 centésimo 309
 centímetro m 310
 cento e dez 308
 centopeia f 295
 centrifugadora f 76
 centrifugar (v) 76
 centro comercial m 104
 centro de jardinagem m 115
 centro de saúde m 168
 centro m 122, 164
 cepilho m 242
 cera f 77
 cerca de 320
 cercado m 243
 cereais m 107, 156
 cereal m 130
 cérebro m 19
 cereja d 126
 cerimónia de graduação f 169
 certidão de nascimento f 26
 certo 321
 cerveja amarga f 145
 cerveja f 145, 151
 cerveja preta f 145
 cêrvix m 20, 52
 cerzir (v) 277
 cesariana f 52
 cesta de jardineiro f 88
 cesta f 95, 263
 cesto da roupa para engomar m 76
 cesto da roupa suja m 76
 cesto de costura m 276
 cesto de entrada m 172
 cesto de fruta m 126
 cesto de papéis m 172
 cesto de pendurar m 84
 cesto de saída m 172
 cesto dos brinquedos m 75
 cesto m 106, 207, 226, 245
 cevada f 130, 184
 chá com leite m 149
 chá com limão m 149
 chá de camomila m 149
 chá de hortelã m 149
 chá de infusão m 149
 chá em folha m 144
 chá m 144, 149, 156, 184
 chá preto m 149
 chá verde m 149
 Chade 317
 chalota f 125
 chamada paga no destino f 99
 chaminé f 58, 214, 283
 champã m 145
 champô m 38
 chapéu de cozinheiro m 190
 chapéu de sol m 30, 265
 chapéu m 36
 charcutaria f 107, 142
 charuto m 112
 chassis m 203
 chave de boca f 80
 chave de caixa f 80
 chave de fendas f 80
 chave do quarto f 100
 chave f 59, 80, 203, 207
 chave inglesa f 80, 81
 chave philips f 80
 chãvena de café f 65
 chãvena de chá f 65
 check-up m 50
 cheddar m 142
 chefe de claque f 220
 chefe de cozinha m 152, 190
 chefe m 24
 chegadas f 213
 cheio 64, 266, 321
 cheque de viagem m 97
 cheque m 96
 chest press m 251
 chifre m 291
 Chile 315
 China 318
 chinelo de enfiar no dedo m 37
 Chipre 316
 chocado 25
 chocalho m 74
 choco m 121
 chocolate branco m 113
 chocolate de barrar m 135
 chocolate de leite m 113
 chocolate m 113
 chocolate preto m 113
 chocolate quente m 144, 156
 choque eléctrico m 46
 choque m 47
 chorar (v) 25
 chouriço de sangue m 157
 chouriço m 143
 chupa-chupa m 113
 churrasco m 267
 chutar (v) 221, 223
 chutney m 135
 chuva com neve f 286
 chuva f 287
 chuvoso 286
 cidlismo m 263
 cidovia f 206
 Cidade do Vaticano 316
 cidade f 298, 299
 ciências f 162, 166
 cientista m 190
 cigarros m 112

- dilha f 242
 cilindro m 164, 187
 címbalo m 257
 dimento m 186
 cinco 308
 cinema m 255, 299
 cinquenta 308
 cinquenta e cinco mil e quinhentos 309
 cinquenta mil 309
 cinto de pesos m 239
 cinto de segurança m 198
 cinto de segurança m 211
 cinto m 32, 36
 tinta f 12
 cinturão das ferramentas m 186
 cinza f 283
 cinzeiro m 150
 cinzel m 275
 cinzento 39, 274
 círculo Ártico m 283
 círculo central m 222, 224, 226
 círculo de posição de jogo m 224
 círculo m 164
 circunferência f 164
 cirurgia f 49
 cirurgia plástica f 49
 cirurgião m 48
 cisne m 293
 cisterna f 61
 citação f 180
 citrinos m 126
 citronela f 133
 claquete f 179
 clara 41
 clara f 137
 clarinete baixo m 257
 clarinete m 257
 claro 321
 classe económica f 211
 classe executiva f 211
 clave de fá f 256
 clave de sol f 256
 clavícula f 17
 dementina f 126
 cliente f 38
 cliente m 96, 104, 106, 152, 175, 180
 clínica f 48
 clip m 173
 dítoris m 20
 clube m 232
 coador m 68
 cobertura acolchoada f 71
 cobertura f 240
 coberto de chocolate 140
 cobertor eléctrico m 71
 cobertor m 71, 74
 cobertura f 141, 155
 cobre 39
 cobre m 289
 cobrir a terra (v) 92
 cobrir de relva (v) 90
 cóccix m 17
 cockpit m 210
 cocktail m 151
 coco m 129
 código de barras m 106
 código postal m 98
 codorniz f 119
 coelho m 118, 290
 coentro m 133
 cogumelo m 125
 coito m 20
 cola de madeira f 78
 cola de papel de parede f 82
 cola f 144, 275
 colagem f 275
 colar cervical m 46
 colar de pérolas m 36
 colar m 36
 colarinho m 32
 colcha f 70
 colchão insuflável m 267
 colchão m 70, 74
 colchete fêmea m 276
 colchete macho m 276
 colega m 24
 colete de salvação m 240
 colete m 33
 colheita f 183
 colheitas f 184
 colher f 65
 colher (v) 183
 colher de café f 153
 colher de chá f 65
 colher de pau f 68
 colher de pedreiro f 187
 colher de servir f 68
 colher de sopa f 65
 colher de transplante f 89
 colher doseadora f 109
 colher para gelado f 68
 colher perfurada f 68
 colibri m 292
 cólicas f 44
 colina f 284
 collants f 34, 35
 collants sem pés m 251
 colocar azulejos (v) 82
 colocar o papel (v) 82
 Colômbia 315
 colónia f 315
 colorau m 132
 coluna f 258, 268, 300
 colza f 184
 com 320
 com alta 48
 com arames 35
 com brilho 35
 com chumbo 199
 com corrente 60
 com gás 144
 com gelo 151
 com sal 137
 comando m 269
 comandos de aquecimento m 201
 combate m 237
 combinação f 35
 comboio a gasóleo m 208
 comboio a vapor m 208
 comboio de alta velocidade m 208
 comboio de mercadorias m 208
 comboio eléctrico m 208
 comboio intercity m 209
 comboio m 208
 começar a escola (v) 26
 comédia f 255
 comedouro m 183
 comer (v) 64
 comer fora 147
 cometa m 280
 comida f 75, 149
 comida frita chinesa f 158
 comida para animais f 107
 comida pronta f 107
 comida rápida f 154
 cominhos m 132
 comissão f 97
 cômoda f 70
 Comores 317
 compacto m 199
 companheiro/a m/f 23
 compartimento das bagagens m 210
 compasso m 165
 compota de framboesa f 134
 compota f 156
 compras f 103
 comprido 32, 34
 comprimento de onda m 179
 comprimento m 165, 310
 comprimido m 109
 comprimido para dormir m 109
 comprimidos para o enjoo m 109
 computador de secretária m 177
 computador m 172, 176
 comunicações f 98
 conceber 20
 concepção f 52
 concerto de rock m 258
 concerto m 255, 258
 concha f 68, 265
 concurso hípico de saltos m 243
 concurso m 178
 concussão f 46
 condimentos e as pastas de barrar m 135
 conduzir (v) 195
 cone m 164, 187
 confeitaria f 107, 114
 confiante 25
 confuso 25
 congelado 121, 124
 congelador m 67
 congelados m 107
 congelar (v) 67
 conglomerado m 288
 Congo 317
 conhecido m 24
 conífera f 86
 conseguir um emprego (v) 26
 conservante m 83
 conservas f 107
 conservatório m 169
 consola f 269
 consommé m 158
 constelação f 281
 constipação f 44
 construção f 186
 construir (v) 186
 construtor m 186, 188
 consulta f 45
 consultório m 45
 conta corrente f 96
 conta de e-mail f 177
 conta de poupança f 96
 conta f 152
 contabilista m 97, 190
 contador da electricidade m 60
 conta-gotas m 109, 167
 conta-quilómetros m 201
 contar (v) 165
 conta-rotações m 201
 contentor do lixo m 266
 contentor m 216
 continente m 282, 315
 contrabaixo m 256
 contracção f 52
 contracepção f 21
 contrafagote m 257
 contraforte m 301
 contraplacado m 79
 controlo de passaportes m 213
 controlos m 201, 204
 convector m 60
 convés m 214
 convidado m 64
 copas 273
 co-piloto m 211
 copo de água m 65
 copo de laboratório m 167
 copo de vinho m 65
 copo m 152
 copos m 150
 coração m 18, 119, 127
 corante de madeiras m 79
 corcova f 291
 corda da roupa f 76
 corda f 230, 248, 258, 266
 cordame m 215, 240
 cordão umbilical m 52
 cordas vocais f 19
 cordeiro m 185
 Coreia do Norte 318
 Coreia do Sul 318
 cores f 39, 274
 corné inglês m 257
 córnea f 51
 cornija f 300
 corno m 291
 coroa m 301
 coroa dentária f 50
 coroa f 111
 corpo m 12
 corredor de velocidade m 234
 corredor m 106, 168, 210, 234, 254
 correia da ventoinha f 203
 correia de comando f 203
 correia transportadora f 106
 correio registado m 98
 correios m 98
 corrente alterna f 60
 corrente contínua f 60
 corrente eléctrica f 60
 corrente f 59, 206
 correr (v) 229
 correspondente m 24
 corretor da bolsa m 97
 corrida de barreiras f 235
 corrida de carruagens f 243
 corrida de cavalos f 243
 corrida de estafetas f 235
 corrida de obstáculos f 243
 corrida de trote f 243
 corrida f 228, 234
 corrida plana f 243
 corrimão m 59, 196
 Córsega 316
 cortador m 80
 cortar (v) 38, 67, 79, 277
 cortar a relva (v) 90
 corta-tubos m 81
 corta-unhas m 41
 corta-vento m 265
 corte de corrente m 60
 corte m 46, 282
 cortes de carne m 119
 cortina de rede f 63
 cortina do chuveiro f 72
 cortina f 63, 254
 corvo m 292
 cós m 35
 coser (v) 277
 Costa do Marfim 317
 costa f 285
 Costa Rica 314
 costas 13, 64, 239
 costas do assento f 210
 costela f 17, 119
 costeleta f 119
 costura f 34
 costureira f 191
 cotação das acções f 97
 cotovelo m 13
 couro cabeludo m 39
 couro m 119
 couro chinesa f 123
 couve f 123
 couve frisada f 123
 couve penca f 123
 couve roxa f 123
 couve-de-bruxelas f 123
 couve-flor f 124
 couve-nabo f 125

- couve-rábano f 123
 covinha f 15
 coxa f 12, 119
 cozer ao vapor (v) 67
 cozer em fogo lento (v) 67
 cozer no forno (v) 138
 cozido no forno 159
 cozinha f 66, 152, 214
 cozinhar 67
 crachã de identificação
 m 189
 crachã m 94
 cracker m 139
 crânio m 17
 cratera f 283
 cravelha f 258
 cravinhos m 133
 cravo m 110
 crawl 239
 cré m 288
 creme autobronzeador m 41
 creme de limão m 134
 creme m 109, 140
 creme para a cara m 73
 creme para as assaduras
 m 74
 creme pasteleiro m 140
 creme pós-solar m 108
 creme protector total m 108
 creme solar m 265
 crepes m 155
 cria f 290
 criação de aves f 183
 criação de gado ovino f 183
 criação de suínos f 183
 criado ao ar livre 118
 criança f 23, 31
 criança pequena f 30
 crime m 94
 criminoso m 181
 crina f 242, 291
 críquete m 225
 crisântemo m 110
 cristalino m 51
 cristaloterapia f 55
 crivo m 89
 Croácia 316
 crochet m 277
 crocodilo m 293
 croissant m 156
 cronómetro m 166, 234
 crosta f 139, 282
 cru 124, 129
 cruzamento m 298
 Cuba 314
 cúbito m 17
 cubo de gelo m 151
 cubo m 164
 cuecas de plástico f 30
 cuecas f 33, 35
 cuidado do bebé m 74
 cuidados da pele m 108
 cuidados dentários m 108
 cuidar (v) 92
 culpado 181
 cultivador m 182
 cultivar (v) 92
 cunhada f 23
 cunhado m 23
 cunho m 240
 cúpula f 300
 curado 118, 143, 159
 curativo m 47
 curcuma f 132
 curgete f 125
 curling m 247
 curto 32, 39
 curva 165
 cusuz m 130
 cutelo m 68
 cutícula f 15
- D**
 da estação 129
 dados m 272
 dar as cartas (v) 273
 dar brilho (v) 77
 dar de comer (v) 183
 dar uma tacada longa (v)
 233
 data de devolução f 168
 data do julgamento f 180
 data f 306
 de 320
 de corte justo 35
 de fácil cozedura 130
 de folha caduca 86
 de folha persistente 86
 de grãos curtos 130
 de grãos longos 130
 de quatro portas 200
 de três portas 200
 de vidro m 69
 debaixo de 320
 débito directo m 96
 década f 307
 décimo 309
 décimo nono 309
 décimo oitavo 309
 décimo primeiro 309
 décimo quarto 309
 décimo quinto 309
 décimo segundo 309
 décimo sétimo 309
 décimo sexto 309
 décimo terceiro 309
 deck de madeira m 85
 declaração f 180
 decoração f 82, 141
 decote em V m 33
 decote m 34
 decote recondo m 33
 dedal m 276
 dedaleira f 297
 dedo anelar m 15
 dedo do pé m 15
 dedo grande do pé m 15
 dedo indicador m 15
 dedo médio m 15
 dedo mínimo m 15
 dedo pequeno do pé m 15
 defender (v) 225, 229
 defender baixo (v) 227
 defesa f 181, 220
 defesa m 223
 defesa pessoal f 237
 deitar (v) 67
 deitar-se (v) 71
 deltoide m 16
 demora f 209
 denominador m 165
 dentadura postiça f 50
 dente da roda m 206
 dente m 50, 125, 291
 dente-de-leão m 123, 297
 dentista f 189
 dentista m 50
 dentro 320
 departamento de
 atendimento ao cliente
 m 175
 departamento de
 contabilidade m 175
 departamento de marketing
 m 175
 departamento de pessoal
 m 175
 departamento de vendas
 m 175
 departamento jurídico m 175
 departamento m 169
 depilação a cera f 41
 depois de 320
 depois de amanhã 307
 depositar (v) 96
 depósito da água m 61
 depósito da gasolina m 203
 depósito de combustível
 m 204
 depósito de óleo dos travões
 m 202
 depósito do limpa-pára-
 brisas m 202
 depósito do líquido de
 refrigeração m 202
 depósito do óleo m 204
 depósito m 61
 dermatologia f 49
 descanso do braço m 210
 descapsulador m 150
 descarnador de fios m 81
 descarçador de maçãs m 68
 descartável 109
 descoberto 260
 descoberto m 96
 descolar (v) 211
 descongelar (v) 67
 descoser (v) 277
 desembarcar (v) 217
 desenhadora f 191
 desenhar (v) 92, 162
 desenho m 275
 desenhos animados m 178
 desenrolador de fita adesiva
 m 173
 desentupidor m 81
 Deserto do Sara m 313
 deserto m 285
 desfiladeiro m 284
 desfile m 27
 desfocado 271
 desidratado 129
 desligado 99
 desligar a televisão (v) 269
 deslizar (v) 229
 desmamar (v) 25, 44
 desodorizante m 73
 desodorizantes m 108
 desportista m 191
 de duas portas 200
 desportos aquáticos m 241
 desportos de combate m
 236
 desportos de inverno m 247
 desportos m 219
 destino m 213
 desvio m 195
 detective m 94
 detector de fumo m 95
 detergente m 77
 devolução f 231
 dez 308
 dez mil 309
 dezanove 308
 dezasseis 308
 dezassete 308
 Dezembro 306
 dezoito 308
 dia de Acção de Graças m 27
 dia de Halloween m 27
 dia m 306
 dia útil m 306
 diabetes f 44
 diafragma m 19, 21
 diagonal f 164
 diagrama do metro m 209
 diamante m 288
 diâmetro m 164
 diarreia f 44, 109
 dicionário m 163
 difícil 321
 digestivo 19
 digital 269
 dilatação f 52
 dimensões f 165
 Dinamarca 316
 dinamo m 207
 dinheiro m 97
 diopetria f 51
 dióxido m 128
 diploma m 169
 direcção à direita f 201
 direcção à esquerda f 201
 director m 163, 174, 254
 director-geral m 175
 direita 260
 direira f 260
 direito m 169
 discman m 268
 disco compacto m 269
 disco m 224
 disco-jóquei m 179
 discos protectores m 53
 discutir (v) 163
 disparador m 270
 dispensário m 108
 dispositivo intra-uterino
 DIU m 21
 disquete f 176
 dissertação f 169
 dissolvente m 83
 distância f 310
 distensão cervical f 46
 distóxico 52
 distribuidor m 203
 distrito m 315
 dividendo m 97
 dividido por 165
 dividir (v) 165
 divisa f 97
 divisão f 58
 divisas f 97
 divórcio m 26
 Diwali m 27
 Djibuti 317
 doca f 214, 216
 doca seca f 217
 doce 124, 127, 155
 doce de laranja m 134, 156
 doces a granel m 113
 doces m 113
 doces para barrar m 134
 documentario m 178
 doença de transmissão
 sexual f 20
 doença f 44
 doente 321
 doente externo m 48
 doente f 45
 dois 308
 dois mil 307
 dois mil e um 307
 domingo 306
 Dominica 314
 dominós m 273
 dor de cabeça f 44
 dor de dentes f 50
 dor de estômago f 44
 dorsal m 16
 dose f 64, 109
 dossiê de argolas m 173
 doutoramento m 169
 doze 308
 drenagem f 91
 dressage f 243
 driblar (v) 222
 dromedário m 291
 duche m 72
 duches m 266
 duodeno m 18
 duplas f 230
 duplo 151
 duro 129, 321
 duzentos 308
 DVD m 268
- E**
 éclair m 140
 eclipse m 280
 ecografia f 48, 52

- economia f 169
 ecrã de informação m 213
 ecrã m 97, 176, 255, 269
 eczema f 44
 edifício de escritórios m 298
 edifício histórico m 261
 edifícios e as estruturas m 300
 edifícios m 299
 edredão m 71
 educação física f 162
 efeito m 230
 efeitos secundários m 109
 Egipto 317
 eixo da transmissão m 202
 eixo m 205, 206
 El Salvador 314
 elástico de cabelo m 39
 elástico m 173
 electricidade f 60
 electricista m 188
 eléctrico m 196
 eléctrodo negativo m 167
 eléctrodo positivo m 167
 electrodomésticos m 66, 107
 elefante m 291
 elenco m 254
 elevador m 59, 100, 104
 eliminação de resíduos f 61
 elixir bucal m 72
 elo m 36
 em 320
 em baixo 320
 em banda 58
 em calda 159
 em cima 320
 em cima de 320
 em diferido 178
 em direcção a 320
 em directo 178
 em filetes 121
 em frente de 320
 em molho 159
 em óleo 143
 em puré 159
 em salmoura 143
 em vinagre 159
 e-mail m 177
 embarcadouro m 217
 embarcar (v) 217
 embraiação f 200, 204
 embrião m 52
 embrulho m 111
 ementa do almoço f 152
 ementa do jantar f 152
 ementa f 148, 153, 154
 emergência f 46
 emigrar (v) 26
 Emiratos Árabes Unidos 318
 emoções f 25
 empate m 223, 230
 empena f 300
 empilhadeira f 216
 empilhador m 186
 empregada f 192
 empregada da loja f 188
 empregado da limpeza m 188
 empregado de bar m 191
 empregado do bar m 150
 empregado dos correios m 98
 empregado m 24, 104, 148, 152
 empregadora f 24
 empresa f 175
 empréstimo m 96, 168
 encaixe da chave de caixa m 80
 encaixe para o pé m 207
 encaminhamento m 49
 encaracolado 39
 encargo bancário m 96
 encestar (v) 227
 enchido picante m 142
 enciclopédia f 163
 encomenda f 99
 encosta f 284
 endívia f 122, 123
 endócrino 19
 endocrinologia f 49
 endro m 133
 enfarte do miocárdio m 44
 enfermaria da maternidade f 48
 enfermaria da pediatria f 48
 enfermaria f 45, 48, 52, 189
 enfiar (v) 277
 engarrafamento de trânsito m 195
 engasgar-se (v) 47
 engenharia f 169
 engomar (v) 76
 enguia f 294
 enrolador de mangueira m 89
 ensaio m 220, 221
 ensino superior m 168
 entalhe m 139
 enteada f 23
 enteado m 23
 entorse f 46
 entrada f 59, 153
 entrar em erupção (v) 283
 entre 320
 entrecosto m 155
 entrega em casa f 154
 entrega f 98
 entretenimento no lar m 268
 entrevistador m 179
 entusiasmo 25
 envelope m 98, 173
 envenenamento m 46
 envergonhado 25
 enviar (v) 177
 enxaguar (v) 38, 76
 enxameca f 44
 enxertar (v) 91
 epidural f 52
 epiglote f 19
 epilepsia f 44
 episiotomia f 52
 equação f 165
 Equador 315
 Equador m 283
 equipa f 220, 229
 equipamento de cozinha m 105
 equipamento de escritório m 172
 equipamento de limpeza m 77
 equipamento m 165, 233, 238
 equitação f 242, 263
 Eritreia 317
 errado 321
 erupção f 44
 erva aromática f 86
 erva f 55
 ervas aromáticas e as especiarias f 132
 ervas aromáticas f 133, 134
 ervas daninhas f 86
 ervilha f 122
 ervilhas f 131
 ervilhas secas f 131
 esboço m 275
 escada f 95, 186
 escadas f 59
 escadas rolantes f 104
 escadote m 82
 escala f 256
 escalada f 248
 escalada no gelo f 247
 escalfado 159
 escalfar (v) 67
 escarpelo m 81
 escama f 121, 294
 escamado 121
 escamas f 293
 escaravelho m 295
 escareador m 80
 escavadora mecânica f 187
 escoamento m 61
 escola de Belas Artes f 169
 escola f 162, 299
 escolas f 169
 escorpião m 295
 escorredor m 67
 escorrega m 263
 escota f 241
 escotilha f 281
 escova da sanita f 72
 escova de dentes f 72
 escova de sobancelhas f 40
 escova f 38, 50
 escova para as costas f 73
 escovar (v) 38
 escrever (v) 162
 escritório do advogado m 180
 escritório do chefe do parque m 266
 escritório m 24, 63, 172, 174
 escroto m 21
 escultor m 191
 escultura f 275
 escura 41
 escuro 321
 esfera f 164
 esfoliar (v) 41
 esfregar (v) 77
 esfregona f 77
 esgoto m 299
 esgrima f 249
 Eslováquia 316
 Eslovénia 316
 esmagado 132
 esmagador de alhos m 68
 esmagador de batata m 68
 esmalte m 50
 esmeralda f 288
 esófago m 19
 espaço m 280
 espada f 236
 espadas 273
 Espanha 316
 espantalho m 184
 espartilho de ligas m 35
 espartilho m 35
 espátula de peixe f 68
 espátula f 68, 167
 especialista m 49
 espetarias f 132
 espectadores m 233
 espelho m 40, 63, 71, 167
 espelho retrovisor m 198
 esperma m 20
 espetada f 155, 158
 espeto m 68
 espinafre m 123
 espinha dorsal f 17
 espinha f 121
 espirro m 44
 esponja f 73, 74, 83
 esponja para pó-de-arroz f 40
 espreguiçadeira f 265
 espuma de barbear f 73
 espuma f 148
 esquadro m 165
 esqueleto m 17
 esquerda 260
 esquí 246
 esquí alpino m 247
 esquí aquático m 241
 esquí de fundo m 247
 esquí downhill m 247
 esquí m 241, 246
 esquiador aquático m 241
 esquiadora f 246
 esquilo m 290
 esquina f 298
 esta semana 307
 estabilizador m 210
 estabilizador vertical m 210
 estábulo m 185, 243
 estaca da tenda f 266
 estaca f 90
 estaca vertical f 225
 estação da polícia f 94
 estação de autocarros f 197
 estação de caminho-de-ferro f 208
 estação de rádio f 179
 estação espacial f 281
 estacar (v) 92
 estacionamento para deficientes m 195
 estacionar (v) 195
 estações f 307
 estádio m 223, 234
 estado m 315
 Estados Unidos da América 314
 estaleiro m 217
 estame m 297
 estanho m 289
 estante f 63
 estatueta f 260
 este m 312
 esteira f 267
 estender com o rolo (v) 67
 estenógrafa f 181
 estêreo do carro m 201
 estêreo m 269
 estéril 20, 47
 esterno m 17
 estetoscópio m 45
 estilista m 277
 estilos de jardim m 84
 estilos m 239, 301
 estilos musicais m 259
 estojo da câmara m 271
 estojo das lentes m 51
 estojo de lápis m 163
 estojo m 51
 estômago m 18
 Estónia 316
 espirro m 44
 estore veneziano m 63
 estrada de acesso f 216
 estradas f 194
 estragão m 133
 estratosfera f 286
 estreia f 254
 estreito 321
 estrela f 280
 estrela-do-mar f 295
 estribo m 242
 estrutura f 267
 estrutura para escalar f 263
 estuário m 285
 estudar (v) 82
 estudante m 162
 estudante universitário m 169
 estúdio de gravação m 179
 estúdio de televisão m 178
 estudo m 161
 estufa f 85
 estufado m 158
 estuque m 83
 Etiópia 317
 etiqueta f 172, 173
 etiquetas f 89
 eucálio m 296
 Europa 316
 exactamente 320

- exame dos olhos m 51
 exame m 163
 exame médico m 45
 exaustor m 66
 excesso de bagagem m 212
 executivo m 174
 exercícios de solo m 235
 exercícios m 251
 exosfera f 286
 experiência f 166
 exploração do espaço f 281
 exploração frutícola f 183
 exploração leiteira f 183
 exploração piscícola f 183
 exposição f 261, 271
 expulsão f 223
 extensão eléctrica f 78
 exterior m 198
 extintor de incêndio m 95
 extracção f 50
- F**
 fábrica f 299
 faca de cozinha f 68
 faca de pão f 68
 faca f 65
 face f 14
 fácil 321
 fagote m 257
 faia f 296
 fairway m 232
 faisão m 119, 293
 faixa central f 194
 faixa da esquerda f 194
 faixa de ultrapassagem f 194
 faixa dupla f 195
 faixa f 236
 faixa preta f 237
 faicão m 292
 falta f 223, 226, 228, 230
 família f 22
 faminto 64
 fardo m 184
 farelo m 130
 faringe f 19
 farinha branca f 138
 farinha com farelo f 138
 farinha com fermento f 139
 farinha de ossos f 88
 farinha integral f 138
 farinha para pão f 139
 farinha sem fermento f 139
 farmacêutica f 189
 farmacêutico m 108
 farmácia f 108
 farol dianteiro m 198, 205
 farol m 207, 217
 farol traseiro m 207
 farpa f 46
 fã m 258
 fases da vida f 23
 fatia f 119, 139, 140
 fatia fina f 119
 fatiador m 139
 fato acolchoado m 30
 fato de banho m 238, 265
- fato de cabedal m 205
 fato de esquí m 246
 fato de trabalho m 32
 fato de treino m 31, 32
 fato espacial m 281
 fato isotérmico m 239
 fato-macaco m 83
 fava f 122
 favas f 131
 favo de mel m 134
 fax m 98, 172
 fazendo pão 138
 fazer a cama (v) 71
 fazer água (v) 239
 fazer amigos (v) 26
 fazer corrida estática (v) 251
 fazer download 177
 fazer log-in (v) 177
 fazer marcha atrás (v) 195
 fazer mise (v) 38
 fazer o check-in (v) 212
 fazer o swing (v) 232
 fazer testamento (v) 26
 fazer um chip (v) 233
 fazer um putt (v) 233
 fazer uma defesa (v) 223
 fazer uma entrada (v) 223
 febre dos fenos f 44
 febre f 44
 fechado 260, 321
 fechadura f 59
 fecho da porta m 200
 fecho de segurança m 75
 fecho m 36, 37, 277
 Federação Russa 318
 feijão aduki m 131
 feijão branco m 131
 feijão branco miúdo m 131
 feijão encarnado m 131
 feijão frade m 131
 feijão manteiga m 131
 feijão mung m 131
 feijão pinto m 131
 feijão verde largo m 122
 feijão verde m 122
 feijoa f 128
 feijões e as ervilhas m 131
 feio 321
 feira f 262
 feliz 25
 femininos 20
 fémur m 17
 fenacho m 132
 feng shui m 55
 feno m 184
 férias f 212
 ferida f 46
 ferimento na cabeça m 46
 fermento m 138
 ferradura f 242
 ferramenta de modelação f 275
 ferramentas de jardim f 88
 ferramentas f 187
 ferro de soldar m 81
 ferro m 76, 109, 289
- ferrolho m 59
 ferros de frisar m 38
 ferry m 215, 216
 fértil 20
 fertilização f 20
 fertilizar (v) 92
 fervedor m 66
 ferver (v) 67
 festa de anos f 27
 festa do casamento f 26
 festivais m 27
 feto m 52, 86
 Fevereiro 306
 fibra de média densidade (MDF) f 79
 fibra f 127
 fibra natural f 31
 ficha do doente f 48
 ficha f 60, 272
 ficheiro m 177
 fígado m 18, 188
 figo da Índia m 128
 figo m 129
 fila f 210, 254
 filamento m 60
 filatela f 273
 filete 121
 filetes de alabote m 120
 filha f 22
 filho m 22
 filhos m 23
 filial f 175
 Filipinas 319
 filme de aventura m 255
 filme de desenhos animados m 255
 filme de ficção científica m 255
 filme de suspense m 255
 filme de terror m 255
 filme do oeste m 255
 filme m 260
 filme romântico m 255
 filosofia f 169
 filtro de ar m 202, 204
 filtro de papel m 167
 filtro m 270
 fim 321
 fim-de-semana m 306
 finanças f 97
 Finlândia 316
 fino 321
 fio de prumo m 82
 fio dentário m 50, 72
 fio m 36
 firme 124
 física f 162, 169
 fisioterapia f 49
 fita adesiva f 173
 fita f 27, 39, 111, 141, 235
 fita isolante f 81
 fita métrica f 80, 276
 fita protectora f 83
 fitoterapia f 55
 fivela f 36
 fixador de pé m 241
- flamengo m 142
 flamingo m 292
 flash electrónico m 270
 flash m 270
 flauta f 257
 flautim m 257
 flecha f 249
 flexão com alongamento f 251
 flexão f 251
 flexionar (v) 251
 flor f 122, 297
 florão m 300
 florentina f 141
 flores f 110
 flores secas f 111
 floresta f 285
 floresta tropical f 285
 florete m 249
 florista f 110, 188
 flutuador m 61, 238, 241, 244
 foca f 290
 focar (v) 271
 foinheira f 242
 foinho m 293
 fogão de campismo m 267
 fogão m 67
 fogueira f 266
 folha de louro f 133
 folha de pagamentos f 175
 folha f 122, 296
 folhado m 149
 folhagem f 110
 folhetos m 96
 folículo m 20
 fonte f 85, 177
 fora 225, 228, 320
 fora da pista 247
 fora de jogo m 223
 fora dos limites 226
 forcéps m 53, 167
 forma de bolos f 69
 forma de pudim f 69
 forma de suflé f 69
 forma de tarte f 69
 forma física f 250
 forma individual f 69
 formão m 81
 formas de tratamento f 23
 formas f 164
 formato horizontal m 271
 formato vertical m 271
 formiga f 295
 fornecedor de serviços m 177
 fornecimento de electricidade m 60
 formilho m 112
 fomo m 66
 forquilha f 88
 forrar com papel de parede (v) 82
 forro m 32
 forte 321
 fósforos m 112
 fosso da orquestra m 254
- fosso m 300
 foto (revelada) f 271
 fotocopiar (v) 172
 fotografar (v) 271
 fotografia f 270, 271
 fotógrafo m 191
 fotómetro m 270
 foyer m 255
 fracção f 165
 fraco 321
 fractura f 46
 frágil 98
 fralda de turco f 30
 fralda descartável f 30
 fralda f 75
 fraldário m 104
 framboesa f 127
 framboesa silvestre f 127
 França 316
 frango frito m 155
 frango m 119
 frango preparado m 119
 franquia f 98
 frasco da água m 206
 frasco de vidro m 166
 frasco m 135
 freio m 242
 frequência f 179
 frequentemente 320
 fresco 121, 127, 130
 frésia f 110
 frigideira f 69
 frigorífico m 67
 frigorífico-congelador m 67
 frio 286, 321
 friso m 63, 301
 frito 159
 frito com pouco óleo 159
 frito imerso em óleo 159
 fronha f 71
 frontal m 16
 frontão m 301
 fruta com caroço f 126
 fruta cristalizada f 129
 fruta em conserva f 135
 fruta f 107, 126, 128
 fruta fresca f 157
 fruta seca f 156
 fruta tropical f 129
 fruta-pão f 124
 frutos secos m 129, 151
 fumado 118, 121, 143, 159
 fumar (v) 112
 fumo m 95
 funcho m 122, 133
 fundear (v) 217
 funeral m 26
 funil m 166
 furação m 287
 furar (v) 79
 furo m 203, 207
 fuselagem f 210
 fusível m 60
 futebol americano m 220
 futebol m 222

futebolista m 222

G

Gabão 317
gado m 182, 185
gafanhoto m 295
gaivota f 292
galão m 311
galáxia f 280
galeria de arte f 261
galinha f 185
galinheiro m 185
galo m 185
galope leve m 243
galope m 243
galvanizado 79
gamão m 272
gambas peladas f 120
Gâmbia 317
Gana 317
gancho de mola m 38
gancho m 118, 187
ganhar (v) 273
ganso m 119, 293
garagem f 58
garfo de trinchar m 68
garfo m 65, 153, 207
garfo para flores m 89
garganta f 19
garra f 291, 293
garrafa de ar f 239
garrafa f 61, 311
gasóleo m 199
gasolina f 199
gatinho m 290
gato m 290
gaveta f 66, 70, 172
gaze f 47
geada f 287
géiser m 285
gel de banho m 73
gel de duche m 73
gel m 38, 109
gelado m 137, 149
gelo e limão 151
gelo m 120, 287
gema f 137, 157
gémeos m 23
geminada 58
gingibre m 125, 133
gingiva f 50
genitais m 12
genro m 22
geografia f 162
geometria f 165
Geórgia 318
geração f 23
gerador m 60
geral f 254
gerbera f 110
gerente do banco m 96
gestante 52
gilete descartável f 73
gin m 145
gin tónico m 151
ginásio m 101, 250

ginasta f 235
ginástica f 235
ginástica rítmica 235
ginecologia f 49
ginecologista m 52
gipsófila f 110
gira-discos m 268
girafa f 179, 291
girassol m 184, 297
girino m 294
giz m 162
glaciar m 284
gladiolo m 110
glândula f 19
glândula tireóidea f 18
gnaisse m 288
goiaba f 128
goivo m 110
golfe m 232
golfinho m 290
golfista f 232
golpe com efeito m 230
golpe curto m 230
golpe de direita m 231
golpe de esquerda m 231
golpe m 228, 233
golpes m 231
goma marshmallow f 113
gomas de fruta f 113
gomas em forma de feijão f 113
gomo m 126
gordo 321
gordura f 119
gorila m 291
gorjeta f 152
gotas f 109
gótico 301
grade de segurança f 75
grafite f 289
grama m 310
grampo m 166
Granada 314
granada f 288
grande 321
grande área f 223
grande penalidade f 223
grandes armazéns m 105
granito m 288
granizo m 286
grão de soja m 131
grão m 130
grãos de bico m 131
grãos e as leguminosas m 130
grãos m 130, 144
grãos processados m 130
grau m 169
gravação f 275
gravador de chamadas m 99
gravador de minidiscos m 268
gravador de vídeo m 269
gravar 269
gravata f 32
grávida 52

gravidade f 280
gravidez f 52
gravilha f 88
Grécia 316
greda f 85
green m 232
grelha f 69
grelhado 159
grelhado m 69
grelhar (v) 68
grilo m 295
grinalda f 111
grinpe f 44
gritar (v) 25
Cronelândia 314
groselha branca f 127
groselha negra f 127
groselha vermelha f 127
groselha-espim f 127
grosso 321
grou m 292
grua da câmara f 178
grua f 187, 216
guache m 274
guarda de segurança m 189
guarda do wicket m 225
guarda prisional m 181
guarda-chuva m 36, 233
guarda-costeiro m 217
guarda-fatos m 70
guarda-joias m 36
guarda-lamas m 205
guardanapo de papel m 154
guardanapo m 65, 152
guardar (v) 177
guarda-redes m 222, 224
guarda-sol m 148, 264
Guatemala 314
guaxinim m 290
guelra f 294
guia da linha f 276
guia do papel f 172
guia m 260
guia turística f 260
guiador m 207
Guiana 315
Guiana Francesa 315
guião m 254
guiar (v) 91
guiché m 96, 98
Guiné 317
Guiné Equatorial 317
Guiné-Bissau 317
guita f 89
guitarra baixo f 258
guitarra eléctrica f 258
guitarrista m 258

H
há lugares disponíveis 266
Haiti 314
hambúrguer m 154, 155
hambúrguer vegetariano m 155
hambúrguer de frango m 155
hamburgueria f 154

hamster m 290
handicap m 233
hardware m 176
harpa f 256
haste f 112, 297
Havaí 314
heavy metal m 259
hélice f 211, 214
helicóptero m 211
hematite f 289
hematoma m 46
Hemisfério Norte m 283
Hemisfério Sul m 283
hemorragia f 46
herbicida m 91, 183
hexágono m 164
hidratante m 41
hidroavião m 211
hidrofoilo m 215
hidroterapia f 55
higiene dental f 72
higiene feminina f 108
Himalaias m 313
hipermetropia f 51
hipnoterapia f 55
hipoalérgico 41
hipódromo m 243
hipopótamo m 291
hipoteca f 96
hipotenusa f 164
história da arte f 169
história f 162
hoje 306
holofote m 259
homem de negócios m 175
homem m 12, 13, 23
homeopatia f 55
homogeneizado 137
Honduras 314
hóquei de campo m 224
hóquei m 224
hóquei no gelo m 224
hora de dormir f 74
hora de ponta f 209
hora f 304
horário m 197, 209, 261
horas de visita f 48
horas f 261, 304, 305
hormona f 20
horta f 85, 182
hortelã f 133
hóspede m 100
hospedeira do ar f 190
hospital m 48
hotel m 100, 264
hovercraft m 215
húmero m 17
húmido 286, 321
Hungria 316

ígneas 288
handicap f 200
igreja f 299, 300
igual a 165
iguana f 293
ilha f 282
Ilhas Baleares 316
Ilhas Galápagos 315
Ilhas Malvinas 315
Ilhas Salomão 319
ilhó f 37
iluminação f 105, 178
iman m 167
imigração f 12
imobilização f 237
impermeável m 31, 32
imposto m 96
impotente 20
imprensa f 178
impressão digital f 94
impressão f 275
impressora f 172, 176
imprimir (v) 172
inalador m 44, 109
incêndio m 95
incisivo m 50
inconsciente 47
incubadora f 53
Índia 318
indicações f 260
indicador da gasolina m 201
indicador de fotos m 270
indicador de temperatura m 201
individual m 64
Indonésia 319
infecção f 44
informação f 168, 261
inhome m 125
iniciar (v) 233
início 321
injecção f 48
inocente 181
inquilino m 58
insónia f 71
inspector m 94
instalações internas f 60
instalar (v) 177
instruções f 109
instrumentos de corda m 256
instrumentos de percussão m 257
instrumentos de sopro de madeira m 257
instrumentos de sopro de metal m 257
instrumentos m 256, 258
insulina f 109
integral 130
inteiro 129, 132
intercomunicador m 59
intercostal m 16
interessante 321
interior m 200
internado 48
internet f 177
interruptor das luzes m 201
interruptor m 60

- intervalo m 223, 254
 intestino delgado m 18
 intestino grosso m 18
 inundação f 287
 inverno m 31, 307
 invertebrados m 295
 investigação f 94, 169
 investimento m 97
 loga m 54
 iogurte congelado m 137
 iogurte de frutas m 157
 iogurte m 137
 ionosfera f 286
 ir dormir (v) 71
 irã 318
 Iraque 318
 íris f 51, 110
 Irlanda 316
 irmã f 22
 irmão m 22
 isca f 244
 iscar (v) 245
 isco artificial m 244
 isolada 58
 isolamento m 61
 isqueiro m 112
 Israel 318
 Itália 316
 itinerário m 260
- J**
 jacaré m 167, 293
 jacto de água m 95
 jacto privado m 211
 jade m 288
 Jamaica 314
 Janeiro 306
 janela do sótão f 58
 janela f 58, 177, 186, 197, 209, 210
 jantar m 64, 158
 jante f 206
 Japão 318
 jarda f 310
 jardim aquático m 84
 jardim campestre m 84
 jardim clássico m 84
 jardim de pedras m 84
 jardim de plantas herbáceas m 84
 jardim de terraço m 84
 jardim m 84
 jardim zoológico m 262
 jardinagem f 90
 jardineiras f 30
 jardineiro m 188
 jardins clássicos m 262
 jardins m 261
 jarra f 63, 111
 jarro graduado m 69, 311
 jarro m 65, 151
 jazz m 259
 jet ski m 241
 joalheria f 114, 275
 joalheiro m 188
 joaninha f 295
- joelheira f 205, 227
 joelho m 12
 jogada f 273
 jogador m 220, 221, 224, 225, 226, 231, 273
 jogar (v) 229, 273
 jogging m 251, 263
 jogo das damas m 272
 jogo de boxe m 236
 jogo de vídeo m 269
 jogo m 230, 273
 jogos de raquete m 231
 jogos de tabuleiro m 272
 jogos m 75, 272
 jóias f 36
 joker m 273
 Jordânia 318
 jornal m 112
 jornalista m 191
 jovem 321
 juba f 291
 judo m 236
 Jugoslávia 316
 juiz de linha m 220, 223, 230
 juiz m 180
 Julho 306
 junco m 86
 Junho 306
 junta f 61
 Júpiter 280
 júri m 180
- K**
 Kaliningrado 316
 karatê m 236
 kendo m 236
 ketchup m 135
 kickboxing m 236
 kit de reparações m 207
 kiwi m 128
 koala m 291
 kumquat m 126
 kung fu m 236
 Kuwait 318
- L**
 lâ de aço f 81
 lâ f 277
 lábio m 14
 lábios m 20
 laboratório m 166
 laca f 38
 laço m 36
 lacrosse m 249
 lactidínios m 107, 136
 lactose f 137
 lado m 164
 lagarta f 295
 lagarto m 293
 lago m 85, 285
 lagosta f 121, 295
 lagostim do rio m 121
 lágrima f 51
 lâmina de barbear f 73
 lâmina do rotor f 211
 lâmina f 66, 78, 89, 167, 246
- laminado 132
 lâmpada f 60, 217
 lança f 95
 lançador m 225, 229
 lança-foguetes m 281
 lançamento do dardo m 234
 lançamento do disco m 234
 lançamento do peso m 234
 lançamento entre dois m 226
 lançamento lateral m 223, 226
 lançamento m 281
 lançar (v) 225, 227, 229, 245
 lancha rápida f 214
 lanchas rápidas f 241
 lanterna f 267
 Laos 318
 lapela f 32
 lápis corrector m 40
 lápis de contorno m 40
 lápis de cor m 163
 lápis de olhos m 40
 lápis de sobranceiras m 40
 lápis m 163, 275
 laptop m 175, 176
 lar m 57
 laranja 274
 laranja f 126
 laranjada f 144
 lareira f 63
 largo 321
 largura f 165
 larício m 296
 laringe f 19
 lata de bebida f 154
 lata de tinta f 83
 lata f 145, 311
 latitude f 283
 Látvia 316
 lava f 283
 lavagem de carros f 199
 lava-loiças m 61, 66
 lavandaria automática f 115
 lavandaria f 76
 lavar (v) 38, 77
 lavatório m 38
 lavrar (v) 183
 laxativo m 109
 lazer m 253
 leão m 291
 leão marinho m 290
 leg press m 251
 legumes m 107, 122, 124
 lei f 180
 leitão m 185
 leite condensado m 136
 leite de cabra m 136
 leite de limpeza m 41
 leite de ovelha m 137
 leite de vaca m 136
 leite em pó m 137
 leite gordo m 136
 leite m 136, 156
 leite magro m 136
 leite meio gordo m 136
- leitor de cassetes m 269
 leitor de CD m 268
 leitor de DVD m 268
 leitor de MP3 m 268
 leitor de raios X m 45
 leme m 210, 241
 lenço de assoar m 36
 lenço de papel m 108
 lenço de pescoço m 36
 lençol m 71, 74
 lente da objectiva f 167
 lente f 51
 lentes de contacto f 51
 lentilha castanha f 131
 lentilha vermelha f 131
 lento 321
 ler (v) 162
 ler 269
 lesão f 46
 lesma f 295
 Lesoto 317
 letra f 259
 levantamento de pesos m 251
 levantar (v) 97, 251
 levantar-se (v) 71
 leve 321
 levedar (v) 139
 Líbano 318
 libelinha f 295
 liberdade condicional f 181
 Libéria 317
 libertar (v) 245
 Líbia 317
 libra f 310
 licença de pesca f 245
 licenciada f 169
 licenciar-se (v) 26
 lichia f 128
 licor m 145
 Liechtenstein 316
 liga f 35, 223
 ligação à terra f 60
 ligação f 212
 ligadura f 47
 ligadura triangular de suporte f 46
 ligamento m 17
 ligar (v) 177
 ligar a televisão (v) 269
 ligas f 35
 lima de unhas f 41
 lima f 81, 126
 limão m 126
 limite de velocidade m 195
 limonada f 144
 limpa-pára-brisas m 198
 limpar (v) 77
 limpar o pó (v) 77
 limpeza de pele f 41
 limpo 121, 321
 limusina f 199
 linfático 19
 lingerie f 35, 105
 língua f 19, 118
 linguado m 120
- linguas f 162
 linha central f 226
 linha de baliza f 224
 linha de base f 230
 linha de campo f 225
 linha de chegada f 234
 linha de flutuação f 214
 linha de fundo f 221, 226
 linha de golo f 220, 223
 linha de jogo f 225, 229, 233
 linha de lance livre f 226
 linha de partida f 234
 linha de serviço f 230
 linha de três pontos f 226
 linha divisória f 194
 linha f 209, 244, 276
 linha lateral f 220, 221, 226, 230
 linhas f 165
 linho m 184, 277
 lintel m 186
 liquidificador m 66
 líquido amniótico m 52
 líquido de limpeza m 51
 líquido limpa-pára-brisas m 199
 líquido m 77
 lírio m 110
 liso 39
 lista de leitura f 168
 lista de preços f 154
 literatura f 162, 169
 litro m 311
 Lituânia 316
 livraria f 115
 livre 321
 livro de cheques m 96
 livro de registo m 100
 livro m 168
 lixadeira f 78
 lixar (v) 82
 lixívia f 77
 lob m 231
 lóbi m 100
 lobo m 290
 loção de corpo f 73
 locomotiva f 208
 logótipo m 31
 loiça f 105
 loja de animais de estimação f 115
 loja de antiguidades f 114
 loja de artigos de oferta f 114
 loja de artigos usados f 115
 loja de bebidas alcoólicas f 115
 loja de artigos fotográficos f 115
 loja de discos f 115
 loja de doces f 113
 loja de ferragens f 114
 loja de frutas e legumes f 114
 loja de materiais de arte f 115
 loja de mobílias f 115

- loja de produtos naturais f 115
loja f 298
loja franca f 213
lombo m 119, 121
longa metragem m 269
longe 320
longitude f 283
lontra f 290
losango m 164
louça f 64
louça e os talheres f 65
louro 39
louva-a-deus m 295
Lua 280
lua cheia f 280
lua nova f 280
lua-de-mel f 26
lufa f 73
lugar do motorista m 196
lugar m 65, 209, 254, 266
lugar posto na mesa m 152
lugares m 254
luge m 247
lula f 121, 295
lupinos m 297
luta livre f 236
luta sumo f 237
luva de forno f 69
luva f 224, 228, 233, 236, 246
luvas de boxe f 237
luvas de jardinagem f 89
luvas f 30, 36
Luxemburgo 316
luz da entrada f 58
luz de leitura f 210
luz traseira f 204
luzes de emergência f 201
luzes f 94
- M**
maçã de Adão f 19
maçã f 126
maca f 48, 94
macaco m 203, 291
macaco sem pernas m 30
macadâmia f 129
maçapão m 141
Macedônia 316
machado m 95
maís m 132
maço de cigarros m 112
maço m 275, 311
macramê m 277
Madagáscar 317
madeira dura f 79
madeira f 79, 187, 275
madeira macia f 79
madrasta f 23
madrês-silva f 297
maduro 129
mãe f 22
maestro m 256
magma m 283
magnésio m 109
magro 321
Maio 306
- maionese f 135
maís 165
maís tarde 304, 320
mala de mão f 37
mala de pór ao ombro f 37
mala f 162
malagueta f 124, 143
malaquite f 289
malas f 37
Malásia 319
Malawi 317
Maldivas 318
Mali 317
Malta 316
mamíferos m 290
mamilo m 12
manchego m 142
mandado m 180
mandioca f 124
mandril m 78
manequim m 276
manete das mudanças f 201
manga f 34, 128
Marracos 317
mangustão m 128
manhã f 305
manicura f 41
manjerona f 133
manteiga de amendoim f 135
manteiga f 137, 156
manto m 282
manual 200
manual m 163
mão f 13, 15
mapa do mundo m 312
mapa m 195, 261
maquete f 190
maquilhagem f 40
máquina de barbear f 73
máquina de café f 150
máquina de cortar relva f 88, 90
máquina de costura f 276
máquina de cubos de gelo f 67
máquina de exercício f 250
máquina de fax f 172
máquina de lavar e secar roupa f 76
máquina de lavar loiça m 66
máquina de lavar roupa f 76
máquina de raios X f 212
máquina de remo f 250
máquina de secar roupa f 76
máquina de step f 250
máquina do café f 148
máquina fotográfica f 260
maquinaria f 187
Mar Árábico m 313
Mar Báltico m 313
Mar Cáspio m 313
Mar das Caraíbas m 312
Mar do Norte m 312
mar m 264, 282
Mar Mediterrâneo m 313
Mar Negro m 313
Mar Vermelho m 313
- maracas f 257
maracujá m 128
maratona f 234
marcação f 175
marcador m 225, 276
marcar (v) 99, 227
marcar um golo (v) 223
marcas rodoviárias f 194
Março 306
marco de correio m 99
margarida f 110, 297
margarina f 137
margem f 284
marido m 22
marina f 217
marinado 143, 259
marinheiro m 189
mariposa 239
mariposa f 295
mariscos m 121
marmelo m 128
mármore m 288
marreta f 187
Marrocos 317
marsupial m 75
Marte 280
martelar (v) 79
martelo de carne m 68
martelo m 80
martini m 151
máscara f 41, 189, 228, 236, 239, 249
masculinos 21
massa chinesa f 158
massa de profiteroles f 140
massa f 138, 140, 158
massa fina f 140
massa folhada f 140
massagem f 54
mastro m 240
mate 83, 271
matemática f 162, 164
materiais de escritório m 173
materiais m 79, 187
material m 245
maternidade f 49
matrícula f 198
mau 321
mau passe da bola m 220
Maurícia 317
Mauritânia 317
maxila f 14
maxilar m 17
meada f 277
mecânica f 202
mecânico m 188, 203
medalhas f 235
medicação f 109
medicamento m 109
medicamentos fitoterápicos m 108
medicina f 169
médico m 45, 189
medida f 150
medida para líquidos f 311
medidas f 165
- medidor da altura m 45
medidor de tensão arterial m 45
medidor óptico m 150
medir (v) 310
meditação f 54
meia hora 304
meia pensão f 101
meia-noite f 305
meias de liga f 35
meio litro m 311
meio-dia m 305
meios de comunicação social m 178
mel cremoso m 134
mel líquido m 134
melancia f 127
melão m 127
mêlée f 221
melhor 321
melhor marca pessoal f 234
melodia f 259
memória f 176
Menina f 23
menos 165
mensageiro m 99
mensagem de texto f 99
mensagem de voz f 99
mensagens f 100
mensal 307
menstruação f 20
mercado m 115
mercearia f 114
mercearias f 106
Mercúrio 280
mercúrio m 289
merengue m 140
mergulhador m 238
mergulhar (v) 238
mergulho alto m 239
mergulho de partida m 239
mergulho m 239
mergulho submarino m 239
mês m 306
mesa de café f 62
mesa de colar f 82
mesa de mistura f 179
mesa de piquenique f 266
mesa do pequeno-almoço f 156
mesa f 64, 148
mesa-de-cabeceira f 70
mesosfera f 286
mesquita f 300
mestrado m 169
metacarpo m 17
metais m 289
metal m 79
metamórficas 288
metatarso m 17
meteoro m 280
metralhadora f 189
metro m 208, 310
metro quadrado m 310
mexer (v) 67
México 314
- mexilhão m 121, 295
mica f 289
micro m 258
microfone m 179, 258
microondas m 66
microscópio m 167
mil 309
mil e novecentos 307
mil milhões 309
mil novecentos e dez 307
mil novecentos e um 307
milénio m 307
milha f 310
milho doce m 122
milho m 130, 184
milho-miúdo m 130
miligrama m 310
mililitro m 311
milímetro m 310
minerais m 289
minhoca f 295
mini-autocarro m 197
minibar m 101
minuto m 304
miopia f 51
mirtilo m 127
missil m 211
mistura para juntas f 83
misturar (v) 67, 138
miúdos m 118
móbil m 74
móveis e a decoração f 105
Moçambique 317
mocassin m 37
mochila f 31, 37, 267
mocho m 292
moço de estrobaria m 243
moda f 277
modalidades f 243, 247
modelismo m 275
modelo f 169
modem m 176
módulo de gavetas m 172
módulo lunar m 281
moeda f 97
moedas devolvidas f 99
moído 132
mola da roupa f 76
mola f 30, 71
mola para papel f 173
molar m 50
Moldávia 316
molde m 276
moldura f 62, 271
mole 129, 321
molho de tomate m 154
molho m 135, 143, 155
Mónaco 316
monção f 287
mondar (v) 92
Mongólia 318
monho m 39
monitor de bebé m 75
monitor m 53, 172, 176
monocarril m 208
monopólio m 272

- monovolume m 199
 montanha f 284
 montanha russa f 262
 Montanhas Rochosas f 312
 montar uma tenda (v) 266
 monte de adubo natural m 85
 monumento m 261
 morada de e-mail f 177
 morada do remetente f 98
 morada f 98
 moradia urbana f 58
 morango m 127
 morcego m 290
 mordedura f 46
 morder (v) 245
 morrer (v) 26
 morsa f 290
 mosca f 244, 273, 295
 mosquito m 267
 mosquito m 295
 mostarda em grão f 135
 mostarda f 155
 mostarda francesa f 135
 mostarda inglesa f 135
 mota de neve f 247
 moto de corridas f 205
 moto de cross f 205
 moto de passeio f 205
 motocicleta f 204
 motociclismo m 249
 motocross m 249
 motor fora-de-borda m 215
 motor m 88, 202, 204, 210
 motorista de autocarro m 190
 motorista de táxi m 190
 motorista m 196
 mousse f 141
 móvel m 268
 mozzarella m 142
 muda-fraldas m 74
 mudanças f 206
 mudar (v) 209
 mudar de canal (v) 269
 mudar de vaso (v) 92
 mudar de velocidade (v) 207
 mudar um pneu (v) 203
 muito 320
 muito quente 286
 mulher de negócios f 175
 mulher f 12, 13, 22, 23
 multiplicar (v) 165
 multivitaminas f 109
 músculos m 16
 museu m 261
 música clássica f 255, 259
 música country f 259
 música de dança f 259
 música f 162
 música folk f 259
 musical m 255
 músico m 191
- N**
 na próxima semana 307
- na semana passada 307
 nabo m 124
 nação f 315
 nadador m 238
 nadar (v) 238
 nádega f 13, 16
 naípe m 273
 Namíbia 317
 namorada f 24
 namorado m 24
 não dobrar (v) 98
 não pasteurizado 137
 narciso m 111
 narina f 14
 nariz m 14, 210
 nascer (v) 26
 nascer do sol m 305
 nascimento m 52
 nata azeda f 137
 nata batida f 137
 nata f 137, 140, 157
 nata gorda f 137
 nata líquida f 137
 natação f 238
 natação sincronizada f 239
 Natal m 27
 natural 256
 naturopatia f 55
 náusea f 44
 navegação por satélite f 201
 navegar (v) 177, 240
 navio de carga m 215
 navio de guerra m 215
 navio m 214
 navio porta-contentores m 215
 neblina f 287
 nebulosa f 280
 nectarina f 126
 negativo m 271
 negócios m 175
 neoclássico 301
 Nepal 318
 Neptuno 280
 nervo m 19, 50
 nervo óptico m 51
 nervoso 19, 25
 neta f 22
 neto m 22
 netos m 23
 neurologia f 49
 neutro 60
 neve f 287
 nevoeiro m 287
 Nicarágua 314
 Níger 317
 Nigéria 317
 níquel m 289
 nível de bolha de ar m 80, 187
 nó do dedo m 15
 nocaute m 237
 noite e o dia f 305
 noite f 305
 noiva f 24
 noivo m 24
- nonagésimo 309
 nono 309
 nora f 22
 normal 39
 norte m 312
 Noruega 316
 nota de cumprimentos f 173
 nota f 97, 163, 256
 notação f 256
 notas f 175, 191
 notícias f 178
 Nova Zelândia 319
 nove 308
 novecentos 308
 Novembro 306
 noventa 308
 novo 321
 noz f 129
 noz moçada f 132
 noz pecan f 129
 nublado 286
 nuca f 13
 núcleo externo m 282
 núcleo interno m 282
 nuggets de frango m 155
 numerador m 165
 número da conta m 96
 número da plataforma m 208
 número da porta de embarque m 213
 número da rota m 196
 número do código secreto m 96
 número do quarto m 100
 número do voo m 212
 número m 226
 números m 308
 nunca 320
 nuvem f 287
 nylon m 277
- O**
 objectiva f 270
 oboé m 257
 obra f 186
 obras na estrada f 187, 195
 obsidiana f 288
 obstáculo de água m 232
 obstetra m 52
 obturação f 50
 obytes m 176
 Oceano Antártico m 313
 Oceano Ártico m 312
 Oceano Atlântico m 312
 Oceano Índico m 313
 oceano m 282
 Oceano Pacífico m 312
 octogésimo 309
 octógono m 164
 ocular f 167
 oculista m 51
 óculos de natação m 238
 óculos de segurança m 81, 167
 óculos de sol m 51, 265
- óculos m 51, 247
 ocupado 99, 321
 oeste m 312
 ofertas f 106
 oficial de diligências m 180
 oficial do tribunal m 180
 oficina f 78, 199
 oftalmologia f 49
 oftalmologista m 189
 oitavo 309
 oitenta 308
 oito 308
 oitocentos 308
 olaria f 275
 óleo aromatizado m 134
 óleo de amêndoas m 134
 óleo de amendoim m 135
 óleo de avelãs m 134
 óleo de colza m 135
 óleo de grassol m 134
 óleo de grainhas de uva m 134
 óleo de milho m 135
 óleo de nozes m 134
 óleo de sésamo m 134
 óleo extraído a frio m 135
 óleo m 142, 199
 óleo vegetal m 135
 óleos essenciais m 55
 óleos m 134
 oleosa 41
 oleoso 39
 olho m 14, 51, 244
 olhos vermelhos m 271
 olmo m 296
 Omã 318
 ombreira f 224
 ombro m 13
 omelete f 158
 omoplata f 17
 onça f 310
 oncologia f 49
 onda f 241
 onda curta f 179
 onda f 241
 onda larga f 179
 onda média f 179
 ónix m 289
 on-line 177
 ontem 306, 320
 onze 308
 opala f 288
 ópera f 255
 operação f 48
 operador de câmara m 178
 orador m 174
 órbita f 280
 ordem de trabalhos f 174
 ordem judicial f 180
 ordenhar (v) 183
 orégãos m 133
 orelha f 14
 orgânico 92
 organizador de ferramentas m 78
 organizador de secretária m 172
- órgãos internos m 18
 órgãos reprodutores m 20
 orgulhoso 25
 orifício nasal m 290
 origami m 275
 ornamental 87
 ornitologia f 263
 orquestra f 254, 256
 orquídea f 111
 ortopedia f 49
 osso m 17, 119
 osteopatia f 54
 ostra f 121
 otorrinolaringologia f 49
 ouriço m 290
 ouro 235
 ouro m 289
 ouros 273
 Outono m 31, 307
 outras artes manuais 275
 outras embarcações 215
 outras lojas f 114
 outros desportos 248
 Outubro 306
 oval f 164
 ovário m 20
 ovelheiro m 65, 137
 ovelha f 185
 ovo cozido m 137, 157
 ovo de codorniz m 137
 ovo de galinha m 137
 ovo de gansa m 137
 ovo de pata m 137
 ovo estrelado m 157
 ovos m 137
 ovos mexidos m 157
 ovulação f 20, 52
 óvulo m 20
- P**
 pá de lixo f 77
 pá f 88, 187, 225, 265
 pacote de chá m 144
 pacote de leite m 136
 pacote m 311
 padaria f 107, 114, 138
 padeiro m 139
 padrasto m 23
 pães e as farinhas m 138
 pagamento m 96
 pagar (v) 153
 pai m 22
 país m 23
 país m 315
 paisagem f 284
 Países Baixos 316
 pala f 37
 palato m 19
 palco m 254
 paleta f 274
 palete f 186
 palheta f 60
 palhinha f 144, 154
 palma da mão f 15
 palmeira f 86, 296

- palmitos m 122
 pálebra f 51
 Panamá 314
 pâncreas m 18
 panda m 291
 pandeireta f 257
 pano de fundo m 254
 pano do pó m 77
 panquecas f 157
 pântano m 285
 pantufas f 31
 pão branco m 139
 pão com bicarbonato de sódio m 139
 pão com sementes m 139
 pão de centeio m 138
 pão de forma m 139
 pão de fruta m 139
 pão de milho m 139
 pão escuro m 139, 149
 pão fatiado m 138
 pão fermentado m 139
 pão granary m 139
 pão integral m 139
 pão m 157
 pão naan m 139
 pão pitta m 139
 pão ralado m 139
 pão sem levedura m 139
 pão-de-ló m 140
 pãozinho de leite m 139
 pãozinho doce m 140
 pãozinho m 139, 155
 papagaio m 293
 papaia f 128
 papas de aveia f 157
 papel com relevo m 83
 papel de base m 83
 papel de lixa m 81, 83
 papel de parede m 82
 papel mâché m 275
 papel timbrado m 173
 papel-cartão m 275
 papoila f 297
 paposcco m 143
 Papua-Nova Guiné 319
 Paquistão 318
 par m 233
 para 320
 para além de 320
 para baixo 320
 para cima 320
 para comer no estabelecimento 154
 para dentro de 320
 para levar 154
 para-brisas m 198, 205
 para-choques m 198
 parafuso m 80
 parafusos da roda m 203
 paragem de autocarro f 299
 paragem de autocarros f 197
 paragem de táxis f 213
 Paraguai 315
 paralela 165
 paralelas assimétricas f 235
 paralelas f 235
 paralelograma m 164
 paramédico m 94
 parapente m 248
 para-quadras m 248
 paraquedismo em queda livre m 248
 paraquedismo m 248
 parar 269
 pardal m 292
 parede f 58, 186
 parentes m 23
 pargo m 120
 parmesão m 142
 parque de campismo m 266
 parque de estacionamento m 298
 parque de safari m 262
 parque infantil m 263
 parque m 75, 262
 parque nacional m 261
 parque temático m 262
 parquímetro m 195
 parte pouco profunda f 239
 parte profunda f 239
 parteira f 53
 participar(v) 174
 partida f 230
 partidas f 213
 partitura f 255, 256
 parto m 52, 53
 parto assistido m 53
 Páscoa f 27
 Páscoa judia f 27
 passa de Corinto f 129
 passa f 129
 passadeira f 250
 passador m 68
 passageiro diário m 208
 passageiro m 216
 passagem de peões f 195
 passagem subterrânea f 194
 passaporte m 213
 passar (v) 220, 221, 223
 passar um pano (v) 77
 passe m 226
 passeio a cavalo m 243
 passeio m 75, 298
 passeio marítimo m 265
 passo m 243
 pasta a receber 177
 pasta de dentes f 72
 pasta f 37, 172, 177
 pasta suspensa f 173
 pastagem f 182
 pastéis m 274
 pastelaria f 69
 pasteurizado 137
 pastilha elástica f 113
 pastilha para a garganta f 109
 pastinaga f 125
 patamar m 59
 pâté m 142, 156
 patilha de apoio f 207
 patilha f 276
 patilhão m 241
 patim de gelo m 224
 patim de rodas m 249
 patim m 247
 patinagem artística f 247
 patinagem de velocidade f 247
 patinagem f 249, 263
 patinagem no gelo f 247
 patinar (v) 224
 patinho m 185
 pátio ajardinado m 84
 pátio da quinta m 182
 pátio m 58, 84
 pato m 119, 185
 patologia f 49
 paulito m 249
 paus 273
 paus de canela m 133
 pausa f 256, 269
 pauta f 256
 pavão m 293
 pavê m 141
 pavimento m 85
 PDA m 175
 pé da coluna m 268
 pé m 12, 15, 111, 310
 pé quadrado m 310
 peão m 272
 peça de carne f 119
 peça exposta f 261
 peça f 254, 272
 pedal dos travões m 205
 pedal m 61, 206
 pedalar (v) 207
 pederneira f 288
 pedestrianismo m 263
 pediatria f 49
 pedicura f 41
 pedir (v) 153
 pedir emprestado (v) 168
 pedra calcária f 288
 pedra de amolar f 81
 pedra f 36, 275
 pedra lunar f 288
 pedra-pomes f 73, 288
 pedras preciosas f 288
 pega f 88, 106
 pegão m 298
 peito do pé m 15
 peito m 12, 119
 peitoral m 16
 peixaria f 114, 120
 peixe e as batatas fritas m 155
 peixe fumado m 143
 peixe m 107, 120
 peixe-dourado m 294
 peixe-espada m 120, 294
 peixeira f 188
 peixes m 294
 pelado 129
 pelador m 68
 pelar (v) 67
 pele branca f 126
 pele f 14, 41, 119
 pelicano m 292
 película f 271
 pelo joelho 34
 peluche m 75
 pélvis f 17
 pena f 293
 pendente m 36
 peneirar (v) 92, 138
 penhasco m 285
 península f 282
 pénis m 21
 pensão completa f 101
 penso higiénico m 108
 penso rápido m 47
 pentágono m 164
 pente m 38
 penteados m 39
 pentear (v) 38
 peónia f 111
 pepino m 125
 pepita de chocolate f 141
 pepperoni m 142
 pequena área f 223
 pequeno 321
 pequeno-almoço inglês m 157
 pequeno-almoço m 64, 156
 pêra f 126
 percentagem f 165
 perdedor m 273
 perder (v) 273
 perfumado 130
 perfumaria f 105
 perfume m 41
 perfurador m 173
 pérgola f 84
 pergunta f 163
 perguntar (v) 163
 periferia f 299
 perigo m 195
 periódico especializado m 168
 periódico m 168
 permanente 39
 perna f 12, 64, 119
 pernada f 239
 pernasas f 31
 perónio m 17
 perpendicular 165
 perseguir (v) 229
 perto 320
 Peru 315
 peru m 119, 185, 293
 pés da cama m 71
 pesado 321
 pesar (v) 310
 pesca com arpão f 245
 pesca com mosca f 245
 pesca de alto mar f 245
 pesca desportiva f 245
 pesca em água doce f 245
 pesca f 244
 pesca marítima f 245
 pesca surfcasting f 245
 pescador à linha m 244
 pescador m 189
 pescoço m 12
 peso à nascença m 53
 peso m 166, 244, 251
 pesos e as medidas m 310
 pesos m 250
 pêssego m 126, 128
 pessoal m 175
 pessoas f 11
 pestana f 14, 51
 pesticida m 89, 183
 pétala f 297
 petroleiro m 215
 peúgas f 33
 pevide f 128
 photo finish m 234
 piano m 256
 picada f 46, 295
 picante 124
 pica-pau m 292
 picareta f 187
 pijama com pés m 30
 pijama m 33
 pilão m 68, 167
 Pilates m 251
 pilha f 167
 pilhas f 260
 piloto de corridas m 249
 piloto m 190, 211
 pilula f 21
 pimenta da Jamaica f 132
 pimenta em grão f 132
 pimenta f 64, 152
 pimento m 124
 pinça f 40, 47, 150, 167
 pinça para o nariz f 238
 pincel m 274
 pincel para lábios m 40
 pincel para massa m 69
 pincel para pó-de-arroz m 40
 pingalim m 242
 pingim m 292
 pinhão m 129
 pinheiro m 296
 pino m 60
 pintado 39
 pintainho m 185
 pintar (v) 83
 pinto m 311
 pintor m 82
 pintora f 191
 pintura f 274
 pior 321
 pipeta f 167
 pipocas f 255
 piquenique m 263
 pirâmide f 164
 piri-piri m 132
 pirite f 289
 pirueta f 235
 pisca-pisca m 198, 204
 piscina f 101, 238, 250
 piscina plástica f 263
 pista de esqui f 246
 pista de hóquei no gelo f 224
 pista f 212, 234, 238
 pistão m 129

- pistola de cola f 78
 pistola f 94
 pizza f 154, 155
 pizzaria f 154
 placa bacteriana f 50
 placa de agulha f 276
 placa f 283
 placa vitrocerâmica f 66
 placar (v) 220, 221
 placenta f 52
 plana f 81
 planador m 211, 248
 planalto m 284
 planeta m 280, 282
 planície f 285
 planta alpina f 87
 planta aquática f 86
 planta de flor f 297
 planta de sombra f 87
 planta de vaso f 87, 110
 planta do centro f 104
 planta f 261
 planta rasteira f 87
 planta suculenta f 87
 plantar (v) 183
 plantas de jardim f 86
 plantas f 296
 plântula f 91
 plataforma do lançador f 228
 plataforma f 208
 plateau de rodagem m 179
 plateau m 178
 plateia f 254
 platina f 167, 289
 Plutão 280
 pneu m 198, 205, 206
 pneu sobresselente m 203
 pó de caril m 132
 pó de talco m 73
 pó m 77, 109
 poçiga f 185
 podadeira de cabo comprido f 88
 podar (v) 90, 91
 pó-de-arroz m 40
 pódio m 235, 256
 podre 127
 poker m 273
 polegada f 310
 polegar m 15
 polícia de trânsito m 195
 polícia f 94
 polícia m 189
 poliéster m 277
 política f 169
 pólo aquático m 239
 pólo m 243, 282
 Pólo Norte m 283
 Polónia 316
 polpa f 124, 127, 129
 poltrona f 63
 polvo m 121, 295
 pomada f 47, 109
 pombo m 292
 ponte de chave de segurança f 80
 ponta f 36, 122, 246
 pontão m 217
 pontapé em salto m 237
 pontapé livre m 222
 pontapé m 237
 pontas da chave de fendas f 80
 pontas espigadas f 39
 ponte de comando f 214
 ponte de embarque f 212
 ponte f 300
 ponteiro das horas m 304
 ponteiro dos minutos m 304
 ponto de ligação eléctrica m 266
 ponto m 273, 277
 pontos m 52
 pontuação f 220, 273
 pop f 259
 popa f 240
 por 320
 pôr a mesa (v) 64
 pôr a roupa na máquina (v) 76
 por baixo 320
 por cima 320
 pôr cobertura (v) 139
 pôr de molho (v) 130
 pôr o despertador para tocar (v) 71
 porão m 215
 porca f 80
 porco m 185
 pôr-do-sol m 305
 poro m 15
 porta automática f 196
 porta da bagageira f 198
 porta de inspecção f 299
 porta do chuveiro f 72
 porta f 176, 196, 198, 209, 247
 porta principal f 58
 porta-aviões m 215
 porta-bagagens m 196, 198, 209
 portalo m 214
 portão m 85, 182
 porteiro m 100
 pórtico m 58
 porto de contentores m 216
 porto de passageiros m 216
 porto de pesca m 217
 porto m 145, 214, 216, 217
 Porto Rico 314
 Portugal 316
 pós-graduado m 169
 posta f 121
 poste da baliza m 222
 poste de iluminação m 298
 poste m 220
 posto de abastecimento m 199
 posto de informação turística m 261
 postura f 232
 pot-pouri m 111
 potro m 185
 poupanças f 96
 praça f 299
 pradaria f 285
 prado m 285
 praia f 264
 prancha de surf f 241
 prancheta de mola f 173
 prata 235
 prata f 289
 prateleira da lareira f 63
 prateleira f 67, 106, 168
 prateleiras f 66
 prato de pão m 65
 prato de sopa m 65
 prato m 65, 310
 prato principal m 153
 prato raso m 65
 pratos do dia m 152
 pratos m 153
 prazo de validade m 109
 preço da entrada m 260
 preço m 152, 199
 prédio de habitação m 298
 preço m 80
 pregos m 233
 prematuro 52
 pré-molar m 50
 pré-natal 52
 prenda f 27
 prensa f 78
 preocupado 25
 prepúcio m 21
 preservativo m 21
 presidir (v) 174
 preso no pescoço 35
 pressão dos pneus f 203
 presunto m 119, 143, 156
 presunto serrano m 143
 preto 39, 272, 274, 321
 primário m 83
 Primavera f 307
 primeira demão f 83
 primeiro 309, 320
 primeiro andar m 104
 primeiros socorros m 47
 primo m 22
 primula f 297
 principado m 315
 prisão f 94, 181
 proa f 214, 240
 problemas m 271
 processador m 176
 processo de tribunal m 180
 procurar (v) 177
 produtor m 254
 produtos de beleza m 105
 produtos de limpeza m 107
 professor m 54, 162, 190
 professor universitário m 169
 profissões f 188, 190
 profundidade f 165
 programa de navegação m 177
 programa m 176, 254, 269
 programação f 178
 proibido parar 195
 proibido virar à direita 195
 projecção f 237
 prolongamento m 223
 propagar (v) 91
 proposta f 174
 propulsor m 281
 próstata f 21
 protector da cara m 225
 protector do pulso m 230
 protector dos dentes m 237
 protector m 83, 88, 236
 protector solar m 108
 protector solar total m 265
 protege-slip m 108
 prova f 181
 província f 315
 provocar o parto (v) 53
 psicoterapia f 55
 psiquiatria f 49
 público m 254
 pudim flan m 141
 pulmão m 18
 pulseira de identificação f 53
 pulseira f 36
 pulso m 13, 15, 47
 pulverizador m 89, 311
 pulverizar (v) 91
 punho m 15, 32, 230, 237
 punk m 259
 pupila f 51
 putter m 233
 puxador m 200
 puzzle m 273
Q
 Qatar 318
 quadrado m 164
 quadragésimo 309
 quadríceps m 16
 quadro (preto) m 162
 quadro de avisos m 173
 quadro de conferência m 174
 quadro m 62, 206, 261
 quantia f 96
 quarenta 308
 quarenta minutos 304
 quarta-feira 306
 quartel dos bombeiros m 95
 quarto 309
 quarto com duas camas m 100
 quarto com pequeno-almoço m 101
 quarto crescente f 280
 quarto das crianças m 74
 quarto de dormir m 70
 quarto de galão m 311
 quarto duplo m 100
 quarto individual m 100
 quarto particular m 48
 quartos m 100
 quartzo m 289
 quatro 308
 quatrocentos 308
 queda de água f 285
 queda f 237
 queijo azul m 136
 queijo creme m 136
 queijo cremoso m 136
 queijo curado m 136
 queijo de cabra m 142
 queijo fresco m 136
 queijo m 136, 156
 queijo ralado m 136
 queijo semicremoso m 136
 queijo semicurado m 136
 queimador m 61, 67
 queimadura f 46
 queimadura solar f 46
 queixa f 94
 queixo m 14
 Quênia 317
 quente 286, 321
 queque m 140
 quiabo m 122
 quiche f 142
 quilha f 214
 quilograma m 310
 quilómetro m 310
 química f 162
 quinhentos 308
 quinoa f 130
 quinagésimo 309
 quinta de terras aráveis f 183
 quinta f 182, 184
 quinta-feira 306
 quinto 309
 quinze 308
 quinzena f 307
 Quirguistão 318
 quiroprática f 54
R
 rã f 294
 rabanete m 124
 rabano picante m 125
 rabichos m 39
 rabo de cavalo m 39
 radar m 214, 281
 radiador m 60, 202
 rádio despertador m 70
 rádio f 179
 rádio m 17, 268
 radiografia f 48, 50
 radiologia f 49
 rafting m 241
 râguebi m 221
 raia f 120
 raia ovípara f 294
 raia vivípara f 294
 rainha f 272, 273
 rainúnculo amarelo m 297
 raio m 164, 207
 raios ultravioleta m 286
 raios x dentários m 50
 raiz de taro f 124
 raiz f 50, 124, 296
 raízes f 39
 ralador m 68
 ralar (v) 67
 rally m 249
 ralo m 89

- RAM f 176
 Ramadão m 27
 raminho m 296
 ramo aromático m 132
 ramo de flores m 35
 ramo m 111, 296
 rampa de lançamento f 281
 ranhura do cartão f 97
 rap m 259
 rapariga f 23
 rapaz m 23
 rapel m 248
 rápido 321
 rápidos m 241, 284
 raposa f 290
 raquete f 230, 231, 249
 raquetebol m 231
 raramente 320
 raspador m 82
 raspar (v) 77
 raspar com a vassoura de relva (v) 90
 ratazana f 290
 rato m 176, 290
 reanimação f 47
 reaquecer (v) 154
 rebanho m 183
 rebentação f 241
 rebento de soja m 122
 rebento m 111
 rebobinar (v) 269
 rebocador m 215
 rebocar (v) 195
 reboque de bagagem m 212
 reboque m 203
 rebote m 226
 rebuçado de menta m 113
 rebuçados m 113
 receber (v) 177
 receita f 45
 recém-nascido m 53
 recepção f 100
 recepcionista f 100, 190
 recheado 159
 recheio m 140, 155
 recibo m 152
 recidagem 177
 recife de coral m 285
 recipiente m 311
 recolha de bagagens f 213
 recolha f 98
 recolher (v) 245
 recordações f 260
 recorde m 234
 recta 165
 rectângulo m 164
 recto m 21
 recurso m 181
 redacção f 163
 redactora f 191
 rede f 176, 217, 222, 226, 227, 231
 rede ferroviária f 209
 rede para o peixe capturado f 244
 redel 230
- rédeas f 242
 redil m 185
 reduzir (v) 172
 refeição de hambúrguer f 154
 refeição f 64
 refeição para crianças f 153
 refetório m 168
 referência 303
 reflector m 50, 204, 207
 reflexologia f 54
 reflexos m 39
 reformar-se (v) 26
 refrescos m 144
 refrigerante m 154
 rega f 89
 regador m 89
 regar (v) 90, 183
 reggae m 259
 região f 315
 região plantar f 15
 régua f 163, 165
 regulador m 239
 rei m 272, 273
 reiki m 55
 Reino Unido 316
 relações f 24
 relâmpago m 287
 relatório m 174
 relaxamento m 55
 relógio de sol m 262
 relógio despertador m 70
 relógio m 36, 62, 304
 relva f 87, 90, 262
 relvado m 85
 remador m 241
 remar (v) 241
 remendo m 207
 remo m 241
 removedor de verniz m 41
 renascentista 301
 renda de bilros f 277
 renda f 35, 58
 renovar (v) 168
 repavimentação f 187
 repelente de insectos m 108, 267
 repórter m 179
 reprodução f 20
 reproduzidor 19
 répteis m 293
 República Centro-Africana 317
 República Checa 316
 República Democrática do Congo 317
 República Dominicana 314
 queijeão m 136
 rés-do-chão m 104
 reservar uma passagem (v) 212
 reservar (v) 168
 resfriado m 44
 resguardo anti-salpicos m 66
 resguardo m 74
 residência universitária f 168
 resíduos orgânicos m 61
- resistência f 61
 resistente ao forno 69
 respiração f 47
 respiratório 19
 responder (v) 163
 resposta f 163
 ressonar (v) 71
 restaurante m 101, 152
 resutoria m 49
 retina f 51
 retrato-robô m 181
 retroprojector m 163, 174
 retrospectiva f 105
 retrovisor lateral m 198
 réu m 181
 reunião f 174
 revelar (v) 271
 revisor m 209
 revista de banda desenhada f 112
 revista f 112
 revistas f 107
 ribeiro m 285
 rim m 18, 119
 rimel m 40
 ringue de boxe m 237
 rinoceronte m 291
 rio m 284
 rir (v) 25
 ritmo m 259
 robalo m 120
 robe m 35
 robot de cozinha m 66
 roçadora f 88
 rochas f 284, 288
 roccó 301
 roda da frente f 196
 roda de ajuste f 276
 roda dentada f 207
 roda f 198, 207
 roda traseira f 197
 rodapé da cama m 71
 rodas de apoio f 207
 rodeio m 243
 rolha f 134
 rolo de massa m 69
 rolo de papel higiénico m 72
 rolo m 38, 83, 271, 311
 romã f 128
 Roménia 316
 romper águas (v) 52
 rosa 274
 rosa f 110
 rosca biceps f 251
 rosé 145
 rosmaninho m 133
 rótula f 17
 rotunda f 195
 rough m 232
 roulotte f 266
 roupa casual f 33
 roupa da equipa f 31, 221, 222
 roupa de cama f 71, 74
 roupa de criança f 30
 roupa de dormir f 31
- roupa de homem f 32, 105
 roupa de senhora f 34, 105
 roupa impermeável f 245, 267
 roupa interior f 32
 roupa limpa f 76
 roupa suja f 76
 roupa termo-isolante f 267
 roupão de banho m 73
 roupão m 31, 32
 roupeiro embutido m 71
 roxo 274
 rua de sentido único f 298
 rua f 298
 rua lateral f 299
 Ruanda 317
 rubi m 288
 ruck m 221
 rúcula f 123
 ruga f 15
 ruibarbo m 127
 ruínas famosas f 261
 ruivo 39
 rum com cola m 151
 rum m 145
- S**
 sábado 306
 sabonete m 73
 saboneteira f 73
 saca-rolhas m 150
 sachó m 88
 saco de água quente m 70
 saco de boxe m 237
 saco de compras m 106
 saco de dormir m 267
 saco de golfe m 233
 saco de pasteleiro m 69
 saco de praia m 264
 saco de viagem m 37
 saco do bebé m 75
 saco do correio m 98, 190
 saco m 311
 saco para a relva m 88
 saco plástico m 122
 safira f 288
 sala f 30, 34
 saída de emergência f 95, 210
 saída f 61, 194, 210
 sal m 64, 152
 sala de aula f 162
 sala de embarque f 213
 sala de espera f 45
 sala de estar f 62
 sala de jantar f 64
 sala de leitura f 168
 sala de operações f 48
 sala de reuniões f 174
 sala de urgências f 48
 sala do tribunal f 180
 salada f 149
 salada mista f 158
 salada verde f 158
 salamandra f 294
 salame m 142
- salário m 175
 salgado 121, 129, 143, 155
 salgueiro m 296
 salmão m 120
 salmoneite m 120
 salsa f 133
 salsicha f 155, 157
 salsichas f 118
 saltar (v) 227
 saltar à corda (v) 251
 saltar (v) 67
 salto à vara m 234
 salto de cavalo m 235
 salto em altura m 235
 salto em comprimento m 235
 salto m 37, 243, 247
 salto mortal m 235
 salva f 133
 salva-vidas m 239, 265
 salvo f 228
 sandália f 37
 sandálias f 31
 sanduiche aberta f 155
 sanduiche club f 155
 sanduiche f 155
 sanduiche torrada f 149
 sangramento do nariz m 44
 sanita f 61, 72
 Santa Lúcia 314
 São Marinho 316
 São Tomé e Príncipe 317
 São Vicente e Granadinas 314
 sapataria f 114
 sapato de atacador m 37
 sapato de cabedal m 37
 sapato de cunha m 37
 sapato de golfe m 233
 sapato de homem m 37
 sapatos de cabedal m 32
 sapatos m 34, 37
 sapo m 294
 sapto de salto alto m 37
 Sara Ocidental 317
 sarampo m 44
 sarda f 15
 Sardenha 316
 sardinha f 120
 sarjeta f 299
 satélite m 281
 satsuma f 126
 Saturno 280
 saúde f 43
 sauna f 250
 scanner m 106, 176
 scrabble m 272
 sebe f 85, 90, 182
 seca 41
 secador m 38
 secar (v) 76
 secar com o secador (v) 38
 secção de bagagens f 104
 secção de criança f 104
 secção de sapataria f 104

- seco 39, 130, 145, 286, 321
secretária f 17, 162, 168
século m 307
seda f 277
sedativo m 109
sede f 175
sedimentares 288
segunda-feira 306
segundo 309
segundo andar m 104
segundo balcão m 254
segundo m 304
segurança f 75, 212, 240
seguro m 203
selo nasal m 19
seis 308
seiscientos 308
sela de senhora f 242
sela f 242
selector de ponto m 276
selim m 206
selo m 98
selos m 112
sem 320
sem alças 34
sem chumbo 199
sem espinhas 121
sem gás 144
sem gelo 151
sem gordura 137
sem grãos 127
sem mangas 34
sem pele 121
sem sal 137
semáforo m 194
semana f 306
semanal 307
semear (v) 90, 183
semente de abóbora f 131
semente de girassol f 131
semente de mostarda f 131
semente de sésamo f 131
semente f 122, 127, 130
sementes de funcho f 133
sementes de papoila f 138
sementes f 88, 131
sémola f 130
sempre 320
Senegal 317
Senhor m 23
Senhora f 23
senhorio m 58
sensível 41
sentença f 181
sentido proibido 195
sentido único m 194
separador central m 194
separador m 173
septuagésimo 309
série televisiva f 178
seringa f 109, 167
serpente f 293
serra circular f 78
serra de metais f 81
serra de rodear f 81
serra de vaivém f 78
Serra Leoa 317
serra manual f 89
serrar (v) 79
serrote com costas m 81
serrote m 81
serviço de câmbio m 97
serviço de informações m 99
serviço de lavanderia m 101
serviço de limpeza m 101
serviço de quarto m 101
serviço incluído 152
serviço m 231
serviço não incluído 152
serviços m 93
serviços de atendimento ao cliente m 104
serviços de emergência m 94
serviços m 49, 101
servidor m 176
servir (v) 64, 231
sessenta 308
set m 230
setas f 273
sete 308
setecentos 308
Setembro 306
setenta 308
sétimo 309
sexagésimo 309
sexta-feira 306
sexto 309
shaker m 150
shiatsu m 54
Sibéria f 313
Sicília 316
sidra f 145
silenciador m 203, 204
silencioso 321
silo m 183
silte m 85
simples 151
sinagoga f 300
sinais de trânsito m 195
sinal de trânsito m 298
sinal luminoso m 240
sinal m 14, 104, 209
sincelo m 287
sinfonia f 256
Singapura 319
singulares m 230
sintético 31
sintonizar (v) 179
sintonizar o rádio (v) 269
sirene f 94
Siria 318
sistema de comunicação pública m 209
sistema m 176
sistema solar m 280
sistemas m 19
site da internet m 177
skate m 249
slalom gigante m 247
slalom m 247
smash m 231
snack-bar m 148
snooker m 249
snowboarding m 247
soalheiro 286
soalho m 58, 62, 71
sobrancelha f 14, 51
sobre 320
sobremesa f 153
sobrexposto 271
sobrinha f 23
sobrinho m 23
sobrolho franzido m 25
sócia f 24
soco m 237
sofá m 62
sofá-cama m 63
software m 176
sogra f 23
sogro m 23
Sol 280
sol m 286
sola do pé f 15
sola f 37
solda f 79, 81
soldado m 189
soldar (v) 79
soletrar (v) 162
solha-limão f 120
sólidos m 164
solo m 85
solução desinfetante f 51
solúvel 109
Somália 317
somar (v) 165
sombra de olhos f 40
sonata f 256
sonda f 50
sopa f 153, 158
soprar (v) 141
soro do leite m 137
soro m 53
sorriso m 25
sorvete m 141
sôtão m 58
soufflé m 158
soutien de aramantação m 53
soutien de desporto 35
soutien m 35
spray m 109, 311
squash m 231
Sri Lanka 318
St. Kitts e Nevis 314
stencil m 83
stress m 55
Suazilândia 317
subexposto 271
subir (v) 139
submarino m 215
subsolo m 91
substituição f 223
subtrair (v) 165
Sudão 317
Suécia 316
Suíça 316
sujo 321
sul m 312
sulco m 183
sultana f 129
sumarento 127
sumo de ananás m 149
sumo de frutas m 156
sumo de laranja m 149
sumo de maçã m 149
sumo de tomate m 144, 149
sumo de uva m 144
sumo m 127
sumos e os batidos m 149
supermercado m 105, 106
suplemento m 55
suplente m 223
suporte de bagagem m 204
suporte do grampo m 166
suporte do selim m 206
suporte m 88, 166, 187, 205
suporte para bicicletas m 207
supositório m 109
surf m 241
surfista m 241
Suriname 315
surpreendido 25
suspeito m 94, 181
suspensão f 203, 205
suspitar (v) 25
sustenido 256
sweatshirt f 33
swing de prática m 233
T
tabaco m 112, 184
tabela f 226
tablete de chocolate f 113
tablier m 201
tábua de engomar f 76
tábua para cortar f 68
tabuleiro de forno m 69
tabuleiro de germinação m 89
tabuleiro de papel m 172
tabuleiro de pintura m 83
tabuleiro de xadrez m 272
tabuleiro m 152, 154
tabuleiro para queques m 69
taça f 61, 65
taça misturadora f 66
taco de ferro m 233
taco de hóquei m 224
taco de madeira m 233
taco m 155, 224, 228
tacos de golfe m 233
tae kwon do m 236
tai-chi m 237
Tailândia 318
Taiwan 319
Tajiquistão 318
tala f 47
talão de depósito m 96
talão de levantamento m 96
talão do cheque m 96
talhante m 118, 188
talhar (v) 79
talheres m 64
talho m 114
tâmara f 129
tambor m 245, 258
tambor pequeno m 257
tamboril m 120
tampa da objectiva f 270
tampa da sanita f 72
tampa f 61, 66, 69, 72, 166
tampão de roda m 202
tampão m 108
tandem f 206
tangerina f 126
tantã m 257
Tanzânia 317
tapeçaria f 277
tapete das bagagens m 212
tapete de banheira m 72
tapete m 54, 63
tapete praticável m 235
tarde 320
tarde f 305
tarifa f 197, 209
tarrafa f 244
tartaruga marinha f 293
tartaruga terrestre f 293
tarte de frutas f 140
tarte de natas f 141
tarte f 158
tartes f 143
Tasmânia 319
tatuagem f 41
taxa de câmbio f 97
taxa de juro f 96
tear m 277
teatro m 254
teatro m 299
teclagem f 277
tecido m 276, 277
tecla f 176
teclado m 97, 99, 172, 176, 258
técnicas f 79, 159
técnico de som m 179
tecto de abrir m 202
tecto duplo m 266
tecto m 62
tee m 232, 233
tejadilho m 203
tela f 274
telecadeira f 246
telecomando m 269
teleférico m 246
telefone de cartão m 99
telefone de emergência m 195
telefone de moedas m 99
telefone m 99, 172
telefone sem fios m 99
telefonista m 99
telegrama m 98
telemóvel m 99
telenovela f 178
teleobjectiva f 270
teleponto m 179
telescópio m 281
televisão por cabo f 269
televisor de ecrã panorâmico m 269

- telha f 58, 187
telhado m 58
temperado 159
temperatura f 286
tempero de salada m 158
tempestade f 287
templo m 234, 286, 300
tempo morto m 220
têmpora f 14
temporal m 286
tenaz f 167
tenda de rua f 154
tenda f 267
tendão de Aquiles m 16
tendão do jarrete m 16
tendão m 17
tênis de mesa m 231
tênis m 31, 37, 230, 231, 251
tensão arterial f 44
tensão f 60
tequila f 145
ter um filho (v) 26
terapeuta f 55
terapeuta m 55
terapia de grupo f 55
terça-feira 306
terceiro 309
terebentina f 83
terminal de ferries m 216
terminal m 212
térmita f 295
termo m 267
termómetro m 45, 167
termosfera f 286
termóstato m 61
Terra 280
terra adubada f 88
Terra f 282
terra firme f 282
terramoto m 283
terras de cultivo f 182
território m 315
tese f 169
tesoura de jardim f 89
tesoura de podar f 89
tesoura de unhas f 41
tesoura f 138, 47, 82, 88, 276
testa f 14
teste de gravidez m 52
testeira f 242
testemunha f 180
testículo m 21
tetina f 75
têxtels para o lar m 105
tia f 22
tibia f 17
tiebreak m 230
tigela f 69
tigre m 291
tijolo m 187
tilia f 296
tímbale m 257
tímido 25
Timor-Leste 319
tinta acrílica f 274
tinta de água f 83
tinta do cabelo f 40
tinta f 83, 275
tintas de óleo f 274
tintas f 274
tinto 145
tinturaria f 115
tio m 22
tipos de autocarros m 196
tipos de câmara m 270
tipos de comboio m 208
tipos de pesca m 245
tipos de plantas m 86
tipos de quinta m 183
tipos m 199, 205
tira-cápsulas m 68
tirar apontamentos (v) 163
tirar as flores mortas (v) 91
tiro ao alvo m 249
tiro ao arco m 249
título m 168
títulos m 97
toalha de banho f 73
toalha de mãos f 73
toalha de mesa f 64
toalha de praia f 265
toalhas f 73
toalheiro m 72
toalhita anti-séptica f 47
toalhita húmida f 74, 108
todo-o-terreno m 199
toga f 169
Togo 317
toldo m 148, 264
tom m 256
tomada f 60
tomar banhos de sol (v) 264
tomar um banho (v) 72
tomar um duche (v) 72
tomate cereja m 124
tomate m 125, 157
tombadillo superior m 214
tomilho m 133
tonalidade f 41
tonelada f 310
tónico m 41
top m 251
topázio m 288
topiária f 87
toranja f 126
tornado m 287
torneir (v) 79
torneio m 233
torneira de água fria f 72
torneira de água quente f 72
torneira de cerveja f 150
torneira de drenagem f 61
torneira f 61, 66
torno de bancada m 78
torno do oleiro m 275
tornozelo m 13, 15
torrada f 157
torradeira f 66
torrado 129
torrão m 113
torre de comando f 215
torre de controlo 212
torre de viglância f 265
torre f 272, 300
tosse f 44
tosta f 157
touca de natação f 238
toucador m 71
touro m 185
trabalho de casa m 163
trabalho de retalhos m 277
trabalho em madeira m 275
trabalho m 171
tractor m 182
tráfego m 194
traje m 255
trampolim m 235, 238
trança f 39
transatlântico m 214
transferência bancária f 96
transferidor m 165
transformador m 60
transmissão f 179, 202
transmitir (v) 178
transplantar (v) 91
transportes m 193
tranvia m 208
trapézio m 16, 164
traqueia f 18
trasto m 258
tratamento da roupa m 76
tratamentos de beleza m 41
travão de mão m 203
travão m 200, 204, 206
travar (v) 207
trave f 235
travessa para gratinar f 69
treinadora pessoal f 250
treinamento m 237
treinar (v) 251
treino em circuito m 251
treliça f 84
trem de aterragem dianteiro m 210
trem de aterragem m 210
tremor m 283
trenó com cães m 247
trepadeira f 87
três 308
trevo m 297
treze 308
trezentos 308
triângulo m 164, 257
tríceps m 16
triçõ m 277
trigésimo 309
trigo m 130, 184
trigo partido m 130
trimestre m 52
trincha da cola f 82
trincha de alisar o papel f 82
trincha f 83
Trindade e Tobago 314
trinta 308
tripé m 166, 270, 281
tripulação f 241
triste 25
tritador de lixo m 61
troca de bolas f 230
tromba f 291
trombone m 257
trompa de Falópio f 20
trompa f 257
trompeta m 257
tronco m 296
Trópico de Câncer m 283
Trópico de Capricórnio m 283
trópicos m 283
troposfera f 286
trote m 243
trovão m 286
trufa f 113, 125
truta arco-íris f 120
truta f 120
t-shirt f 30, 33
tuba f 257
tubarão m 294
tubo de descarga m 61
tubo de ensaio m 166
tubo de escape m 203, 204
tubo de respiração m 239
tubo do aspirador m 77
tubo m 202, 311
túlipa f 111
Tunísia 317
tupia f 78
turbocompressor m 203
turismo m 260
turista m 260
turmalina f 288
turno m 228
Turquemenistão 318
turquesa f 289
Turquia 316
tutu m 191
- U**
Ucrânia 316
Uganda 317
ugli m 126
última demão f 83
último 320
ultraligeiro m 211
ultrapassar (v) 195
ultra-som m 52
um 308
um milhão 309
um pouco 320
um quarto de hora 304
um shot 151
uma medida 151
umbigo m 12
unha do pé f 15
unha f 15
unidade de classificação do lixo f 61
unidade de cuidados intensivos f 48
unidade de disco rígido f 176
unidade de processamento central f 176
uniforme escolar m 162
uniforme m 94, 189
- universidade f 299
universo m 280
Urano 280
uretra f 20, 21
urinário 19
urologia f 49
ursinho de peluche m 75
urso m 291
urso polar m 291
urtiga f 297
Uruguai 315
urze f 297
usar o fio dentário (v) 50
Usbequistão 318
utensílios de cozinha m 68
útero m 20, 52
uva f 127
uva-dos-montes f 127
- V**
vaca f 185
vacina f 45
vaga de frio f 287
vagão m 209
vagão-cama m 209
vagão-restaurante m 209
vagem f 122
vagina f 20
vaivém espacial m 281
vareta medidora f 202
vareta de vidro f 167
vareta medidora f 202
varicela f 44
varrer (v) 77
vaso m 89
vassoura f 77
vassoura para relva f 88
vassourinha f 77
vazio 321
veado m 291
vedação f 85, 182
vedante m 83
vegetação de cobertura f 87
veia f 19
veículo de serviço m 212
vela de ignição f 203
vela f 63, 240, 241
vela grande f 240
velas de aniversário f 141
velho 321
velo m 74
velocímetro m 201, 204
vencedor m 273
vendedor de doces m 113
vendedor de frutas e legumes m 188
vendedor de jornais m 112

- veneziana f 58
 Venezuela 315
 ventilador m 210
 vento m 241, 286
 ventoinha f 60, 202
 ventosa f 53
 ventoso 286
 Vénus 280
 ver a televisão (v) 269
 Verão m 31, 307
 verde 129, 274
 veredicto m 181
 vermelho 274
 verniz de unhas m 41
 verniz m 79, 83
 vértebras cervicais f 17
 vértebras lombares f 17
 vértebras torácicas f 17
 vértice m 164
 vesícula seminal f 21
 vespa f 205, 295
 vestibulo m 59
 vestido de casamento m 35
 vestido de noite m 34
 vestido m 31, 34
 vestuário m 205
 veterinária f 189
 véu m 35
 vezes 165
 via de acesso f 194
 via de saída f 194
 viaduto m 194
 viagem de negócios f 175
 vibrafone m 257
 viçoso 127
 videotelefone m 99
 vidros m 65
 vieira f 121
 viela f 298
 Vietname 318
 viga de madeira f 186
 viga do telhado f 186
 viga mestra f 186
 vigésimo 309
 vigésimo primeiro 309
 vigésimo segundo 309
 vigésimo terceiro 309
 vigia f 214
 vinagre balsâmico m 135
 vinagre de malte m 135
 vinagre de sidra m 135
 vinagre de vinho m 135
 vinagre m 135, 142
 vinha f 183
 vinho m 145, 151
 vinte 308
 vinte e dois 308
 vinte e um 308
 vinte mil 309
 vinte minutos 304
 viola f 256
 violino m 256
 violoncelo m 256
 virado para dentro 39
 viragem f 238
 virar (v) 241

- virilha f 12
 vírus m 44
 visão f 51
 viseira f 205, 269
 visita guiada f 260
 visor m 271
 visto m 213
 vitaminas f 108
 vitela f 185
 vivaz 86
 vizinho m 24
 voar (v) 211
 vocalista m 258
 vodka com laranja f 151
 vodka f 145
 volante m 201, 231
 voleibol m 227
 voleio m 231
 volume m 165, 179, 269, 311
 vomitar (v) 44
 voo com asa delta m 248
 voo doméstico m 212
 voo internacional m 212
 voo planado m 248
 vulcão m 283

W

- waffles f 157
 wallpaper m 177
 wedge m 233
 whisky escocês com água
 m 151
 whisky m 145
 wicket m 225
 windsurf m 241
 windsurfista m 241
 wok m 69

X

- x-acto m 82
 xadrez m 272
 xarope de acer m 134
 xarope m 109
 xarope para a tosse m 108
 xerez m 145
 xisto m 288

Z

- Zâmbia 317
 zangado 25
 zarpar (v) 217
 zebra f 291
 zero 230, 308
 Zimbábue 317
 zinco m 289
 zona de abastecimento f 199
 zona de ataque
 zona de defesa f 224
 zona de ensaio f 221
 zona de finalização f 220
 zona f 315
 zona industrial f 299
 zona lombar f 13
 zona neutra f 224
 zona pedonal f 299
 zonas f 283, 299

zoologia f 169

Índice inglês • English index

A

- à la carte 152
 abdomen 12
 abdominals 16
 above 320
 abselling 248
 acacia 110
 accelerator 200
 access road 216
 accessories 36, 38
 accident 46
 account number 96
 accountant 97, 190
 accounts department 175
 accused 180
 ace 230, 273
 Achilles tendon 16
 acorn squash 125
 acquaintance 24
 acquitted 181
 across 320
 acrylic paints 274
 actions 237, 229, 227, 233, 183
 activities 263, 245, 162, 77
 actor 254, 191
 actors 179
 actress 254
 acupressure 55
 acupuncture 55
 Adam's apple 19
 add v 165
 address 98
 adhesive tape 47
 adjustable spanner 80
 admissions 168
 admitted 48
 aduki beans 131
 adult 23
 advantage 230
 adventure 255
 advertisement 269
 aerate v 91
 aerobics 251
 Afghanistan 318
 Africa 317
 after 320
 afternoon 305
 aftershave 73
 aftersun 108
 agate 289
 agenda 174
 aikido 236
 aileron 210
 air bag 201
 air conditioning 200
 air cylinder 239
 air filter 202, 204
 air letter 98
 air mattress 267
 air stewardess 190
 air supply 199
 air vent 210
 aircraft 210
 aircraft carrier 215
 airliner 210, 212
 airport 212
 aisle 106, 168, 210, 254
 alarm clock 70
 Alaska 314
 Albania 316
 alcoholic drinks 145
 alfalfa 184
 Algeria 317
 allergy 44
 alley 298
 alligator 293
 allspice 132
 almond 129
 almond oil 134
 almonds 151
 along 320
 alpine 87
 alpine skiing 247
 alternating current 60
 alternative therapy 54
 alternator 203
 altitude 211
 aluminium 289
 Amazonia 312
 ambulance 94
 American football 220
 amethyst 288
 amniocentesis 52
 amniotic fluid 52
 amount 96
 amp 60
 amphibians 294
 amplifier 268
 anaesthetist 48
 anchor 214, 240
 Andes 312
 Andorra 316
 angle 164
 angler 244
 Angola 317
 angry 25
 animals 292, 294
 animated film 255
 ankle 13, 15
 ankle-length 34
 anniversary 26
 annual 86, 307
 anorak 31, 33
 answer 163
 answer v 99, 163
 answering machine 99
 ant 295
 antenatal 52
 antenna 295
 antifreeze 199, 203
 Antigua and Barbuda 314
 anti-inflammatory 109
 antique shop 114
 antiseptic 47
 antiseptic wipe 47
 anti-wrinkle 41
 antler 291
 apartment block 298
 apéritif 153
 aperture dial 270
 apex 165
 appeal 181
 appearance 30
 appendix 18
 applaud v 255
 apple 126
 apple corer 68
 apple juice 149
 appliances 66
 application 176
 appointment 45, 175
 apricot 126
 April 306
 apron 30, 50, 69, 212
 APS camera 270
 aquamarine 288
 Arabian Sea 313
 arable farm 183
 arc 164
 arch 15, 85, 301
 archery 249
 architect 190
 architecture 300
 architrave 301
 Arctic circle 283
 Arctic Ocean 312
 area 165, 310
 areas 299
 arena 243
 Argentina 315
 arithmetic 165
 arm 13
 armband 238
 armchair 63
 Armenia 318
 armpit 13
 armrest 200, 210
 aromatherapy 55
 around 320
 arrangements 111
 arrest 94
 arrivals 213
 arrow 249
 art 162
 art college 169
 art deco 301
 art gallery 261
 art nouveau 301
 art shop 115
 artery 19
 artichoke 124
 artist 274
 arts and crafts 274, 276
 ash 283
 ashtray 150
 Asia 318
 assault 94
 assistant 24
 assisted delivery 53
 asteroid 280
 asthma 44
 astigmatism 51
 astronaut 281
 astronomy 281
 asymmetric bars 235
 at 320
 athlete 234
 athletics 234
 Atlantic Ocean 312
 atmosphere 282, 286
 atrium 104
 attachment 177
 attack 220
 attack zone 224
 attend v 174
 attic 58
 attractions 261
 aubergine 125
 auburn 39
 audience 254
 August 306
 aunt 22
 aurora 286
 Australasia 319
 Australia 319
 Austria 316
 autocue 179
 automatic 200
 automatic door 196
 autumn 31, 307
 avalanche 247
 avenue 299
 avocado 128
 awning 148
 axe 95
 axle 205
 ayurveda 55
 Azerbaijan 318
 bad 321
 badge 94
 badminton 231
 bag 311
 bagel 139
 baggage reclaim 213
 baggage trailer 212
 bags 37
 baguette 138
 Bahamas 314
 bail 181
 bait 244
 bait v 245
 bake v 67, 138
 baked 159
 baker 139
 baker's 114
 bakery 107, 138
 baking 69
 baking tray 69
 balance wheel 276
 balcony 59, 254
 bald 39
 bale 184
 Balearic Islands 316
 ball 15, 75, 221, 224, 226, 228, 230
 ballboy 231
 ballet 255
 balsamic vinegar 135
 Baltic Sea 313
 bamboo 86, 122
 banana 128
 bandage 47
 Bangladesh 318
 banister 59
 bank 96, 284
 bank charge 96
 bank manager 96
 bank transfer 96
 bap 139
 bar 150, 152, 250, 256, 311
 bar code 106
 bar counter 150
 bar mitzvah 26
 bar snacks 151
 bar stool 150
 barb 244
 Barbados 314
 barbecue 267
 barber 39, 188
 bark 296
 barley 130, 184
 barman 191
 barn 182
 baroque 301
 bars 74
 bartender 150
 basalt 288
 base 164, 229
 base station 99
 baseball 228
 baseline 230

B

- baby 23, 30
 baby bath 74
 baby care 74
 baby changing facilities 104
 baby monitor 75
 baby products 107
 baby sling 75
 babygro 30
 back 13
 back brush 73
 back seat 200
 backboard 226
 backdrop 254
 backgammon 272
 backhand 231
 backpack 31, 37, 267
 backstroke 239
 backswing 233
 bacon 118, 157

- baseman 228
 basement 58
 basil 133
 basin 50
 basket 106, 207, 226
 basket of fruit 126
 basketball 226
 basketball player 226
 basque 35
 bass clarinet 257
 bass def 256
 bass guitar 258
 bass guitarist 258
 bassoon 257
 bat 225, 228, 231, 290
 bat v 225, 229
 bath mat 72
 bath towel 73
 bathrobe 73
 bathroom 72
 bathtub 72
 baton 235, 256
 batsman 225
 batter 228
 batteries 260
 battery 167, 202
 battery pack 78
 battleship 215
 bay leaf 133
 bayonet fitting 60
 be born v 26
 beach 264
 beach bag 264
 beach ball 265
 beach hut 264
 beach towel 265
 beach umbrella 264
 beaker 167
 beam 186, 235
 bean sprout 122
 beans 131, 144
 bear 291
 beat 259
 beauty 40, 105
 beauty treatments 41
 bed 70
 bed and breakfast 101
 bed linen 71
 bedding 74
 bedroom 70
 bedside lamp 70
 bedside table 70
 bedspread 70
 bee 295
 beech 296
 beef 118
 beer 145, 151
 beer tap 150
 beetle 295
 beetroot 125
 before 320
 beginning 321
 behind 320
 Belarus 316
 Belgium 316
 Belize 314
 bell 197
 below 320
 belt 32, 36, 236
 bench 250, 262
 Benin 317
 berry 296
 beside 320
 bet 273
 between 320
 beyond 320
 Bhutan 318
 biathlon 247
 bib 30
 bicep curl 251
 biceps 16
 bicycle 206
 bidet 72
 biennial 86
 bifocal 51
 big toe 15
 bike rack 207
 bikini 264
 bill 152, 293
 binoculars 281
 biology 162
 biplane 211
 birch 296
 bird watching 263
 birds 292
 birth 52
 birth weight 53
 birth certificate 26
 birthday 27
 birthday cake 141
 birthday candles 141
 birthday party 27
 biscuit 113
 biscuits 141
 bishop 272
 bit 242
 bit brace 78
 bite 46
 bite v 245
 bitter 124, 145
 black 39, 272, 274
 black belt 237
 black coffee 148
 black hole 280
 black olive 143
 black pudding 157
 Black Sea 313
 black tea 149
 blackberry 127
 blackboard 162
 blackcurrant 127
 black-eyed beans 131
 bladder 20
 blade 60, 66, 78, 89
 blanket 71, 74
 blazer 33
 bleach 77
 blender 66
 blister 46
 block 237
 block v 227
 block of flats 59
 blonde 39
 blood pressure 44
 blood pressure gauge 45
 blood test 48
 blouse 34
 blow dry v 38
 blow out v 141
 blowhole 290
 blue 274
 blue cheese 136
 bluebells 297
 blueberry 127
 blues 259
 blusher 40
 board 241
 board v 217
 board games 272
 boarding pass 213
 bob 39
 bobbin 276
 bobsleigh 247
 body 12
 body lotion 73
 body systems 19
 bodywork 202
 boil v 67
 boiled egg 137, 157
 boiled sweets 113
 boiler 61
 Bolivia 315
 bollard 214, 298
 bolt 59
 bomber 211
 bone 17, 119, 121
 bone meal 88
 boned 121
 bongos 257
 bonnet 198
 book 168
 book a flight v 212
 book shop 115
 bookshelf 63, 168
 boom 95, 240
 booster 281
 boot 198, 220, 223
 booties 30
 bored 25
 borrow v 168
 Bosnia and Herzegovina 316
 Botswana 317
 bottle 61, 75, 135, 311
 bottle opener 68, 150
 bottled foods 134
 bottled water 144
 bottom tier 141
 bounce v 227
 boundary line 225
 bouquet 35, 111
 bouquet garni 132
 bout 237
 boutique 115
 bow 240, 249
 bow tie 36
 bowl 61, 65, 112
 bowl v 225
 bowler 225
 bowling 249
 bowling ball 249
 box 254
 box file 173
 box of chocolates 113
 box of tissues 70
 box office 255
 boxer shorts 33
 boxercise 251
 boxing 236
 boxing gloves 237
 boxing ring 237
 boy 23
 boyfriend 24
 bra 35
 brace 50
 bracelet 36
 brain 19
 brake 200, 204, 206
 brake v 207
 brake block 207
 brake fluid reservoir 202
 brake lever 207
 brake pedal 205
 bran 130
 branch 175, 296
 brandy 145
 brass 256
 Brazil 315
 brazil nut 129
 bread 157
 bread knife 68
 bread roll 143
 breadcrumbs 139
 breadfruit 124
 breads 138
 break a record v 234
 break waters v 52
 breakdown 203
 breakfast 64, 156
 breakfast buffet 156
 breakfast cereals 107
 breakfast table 156
 breakfast tray 101
 breast 12, 119
 breast bone 17
 breast pump 53
 breastfeed v 53
 breaststroke 239
 breathing 47
 breech 52
 brick 187
 bridge 15, 214, 258, 273, 300
 bridle 242
 bridle path 263
 brie 142
 briefcase 37
 briefs 33, 35
 brioche 157
 broad bean 122
 broad beans 131
 broadcast 179
 broadcast v 178
 broccoli 123
 brochure 175
 brogue 37
 bronze 235
 brooch 36
 broom 77
 broth 158
 brother 22
 brother-in-law 23
 browband 242
 brown 274
 brown bread 139, 149
 brown flour 138
 brown lentils 131
 brown rice 130
 browse v 177
 browser 177
 bruise 46
 Brunei 319
 brunette 39
 brain 19
 brush 38, 40, 77, 83, 274
 brush v 38, 50
 brussel sprout 122
 bubble bath 73
 bucket 77, 82, 265
 buckle 36
 bud 111, 297
 buffet 152
 buggy 232
 build v 186
 builder 186, 188
 building site 186
 buildings 299
 built-in wardrobe 71
 bulb 86
 Bulgaria 316
 bull 185
 bulldog clip 173
 bull-nose pliers 80
 bullseye 273
 bumper 74, 198
 bun 39, 140, 155
 bunch 111
 bungalow 58
 bungee jumping 248
 bunker 232
 bunsen burner 166
 buoy 217
 bureau de change 97
 burger 154
 burger bar 154
 burger meal 154
 burglar alarm 58
 burglary 94
 Burkina Faso 317
 Burma (Myanmar) 318
 burn 46
 burner 67
 Burundi 317
 bus 196
 bus driver 190
 bus shelter 197
 bus station 197
 bus stop 197, 299
 bus ticket 197
 buses 196
 business 175
 business class 211
 business deal 175
 business lunch 175
 business partner 24
 business suit 32
 business trip 175

businessman 175
 businesswoman 175
 butcher 118, 188
 butcher's 114
 butter 137, 156
 butter beans 131
 buttercup 297
 butterfly 239, 295
 buttermilk 137
 butternut squash 125
 buttock 13, 16
 button 32
 buttonhole 32
 buttress 301
 by 320
 by airmail 98
 bytes 176

C

cab 95
 cabbage 123
 cabin 210, 214
 Cabinda 317
 cabinet 66
 cable 79, 207
 cable car 246
 cable television 269
 cactus 87
 caddy 233
 caesarean section 162
 café 148, 262
 cafetière 65
 cake shop 114
 cake tin 69
 cakes 140
 calcite 289
 calcium 109
 calculator 165
 calendar 306
 calf 13, 16, 185
 call button 48
 calyx 297
 cam belt 203
 Cambodia 318
 camcorder 260, 269
 camel 291
 camembert 142
 camera 178, 260, 270
 camera case 271
 camera crane 178
 camera shop 115
 cameraman 178
 Cameroon 317
 camisole 35
 camomile tea 149
 camp v 266
 camp bed 266
 campari 145
 camper van 266
 campfire 266
 camping 266
 camping stove 267
 campsite 266
 campus 168
 can 145, 311
 can opener 68

Canada 314
 canary 292
 candied fruit 129
 candle 63
 cane 91
 canes 89
 canine 50
 canned drink 154
 canoe 214
 canoeing 241
 canter 243
 canvas 274
 cap 21, 36, 238
 capacity 311
 cape gooseberry 128
 capers 143
 capital 315
 capoeira 237
 capsiz v 241
 capsule 109
 captain 214
 capuccino 148
 car 198, 200
 car accident 203
 car hire 213
 car park 298
 car stereo 201
 car wash 198
 caramel 113
 caravan 266
 caraway 131
 card 27
 card phone 99
 card slot 97
 cardamom 132
 cardboard 275
 cardigan 32
 cardiology 49
 cardiovascular 19
 cards 273
 cargo 216
 Caribbean Sea 312
 carnation 110
 carnival 27
 carousel 212
 carpenter 188
 carpentry bits 80
 carpet 71
 carriage 208
 carriage race 243
 carrier 204
 carrot 124
 carrycot 75
 cartilage 17
 carton 311
 cartoon 178
 carve v 79
 carving fork 68
 case 51
 cash v 97
 cash machine 97
 cashewnut 129
 cashewnuts 151
 cashier 96, 106
 casino 261
 Caspian Sea 313
 cassava 124

casserole dish 69
 cassette player 269
 cassette tape 269
 cast 254
 cast v 245
 castle 300
 casual 34
 casual wear 33
 cat 290
 catalogue 168
 catamaran 215
 cataract 51
 catch v 220, 227, 229, 245
 catcher 229
 caterpillar 295
 cathedral 300
 catheter 53
 cauliflower 124
 cave 284
 CD player 268
 cedar 296
 ceiling 62
 celebration 140
 celebration cakes 141
 celebrations 27
 celeriac 124
 celery 122
 cell 181
 cello 256
 cement 186
 cement mixer 186
 centimetre 310
 centipede 295
 Central African Republic 317
 central processing unit 176
 central reservation 194
 centre 164
 centre circle 222, 224, 226
 centre field 228
 centre line 226
 centreboard 241
 century 307
 ceramic hob 66
 cereal 130, 156
 cervical vertebrae 17
 cervix 20, 52
 Chad 317
 chain 36, 206
 chair 64
 chair v 174
 chairlift 246
 chalk 85, 162, 288
 chamber 283
 champagne 145
 championship 230
 change v 209
 change a wheel v 203
 change channel v 269
 change gear v 207
 changing bag 75
 changing mat 74
 changing room 104
 channel 178
 charcoal 266, 275
 charge 94, 180
 chart 48
 chassis 203

check-in v 212
 check-in desk 213
 checkout 106
 check-up 50
 cheddar 142
 cheek 14
 cheerleader 220
 cheese 136, 156
 chef 152, 190
 chef's hat 190
 chemist 108
 chemistry 162
 cheque 96
 chequebook 96
 cherry 126
 cherry tomato 124
 chess 272
 chessboard 272
 chest 12
 chest of drawers 70
 chest press 251
 chestnut 129
 chewing gum 113
 chick 185
 chick peas 131
 chicken 119, 185
 chicken burger 155
 chicken coop 185
 chicken nuggets 155
 chicken pox 44
 chicory 122
 child 23, 31
 child lock 75
 child seat 198, 207
 childbirth 53
 children 23
 children's clothing 30
 children's department 104
 children's ward 48
 child's meal 153
 Chile 315
 chili 143
 chill 44
 chilli 124, 132
 chimney 58
 chin 14
 China 318
 china 105
 chip v 233
 chipboard 79
 chiropractic 54
 chisel 81, 275
 chives 133
 chocolate 113
 chocolate bar 113
 chocolate cake 140
 chocolate chip 141
 chocolate coated 140
 chocolate milkshake 149
 chocolate spread 135
 choir 301
 choke v 47
 chop 119, 237
 chopping board 68
 chorizo 143
 choux pastry 140
 christening 26

Christmas 27
 chrysanthemum 110
 chuck 78
 church 298, 300
 chutney 134
 cider 145
 cider vinegar 135
 cigar 112
 cigarettes 112
 cinema 255, 299
 cinema hall 255
 cinnamon 133
 circle 165, 254
 circular saw 78
 circuit training 251
 circumference 164
 cistern 61
 citrus fruit 126
 city 299
 dam 121
 clamp 78, 166
 clamp stand 166
 clapper board 179
 clarinet 257
 clasp 36
 classical music 255, 259
 classroom 162
 claw 291
 clay 85, 275
 clean v 77
 clean clothes 76
 cleaned 121
 cleaner 188
 cleaning equipment 77
 cleaning fluid 51
 cleanser 41
 clear honey 134
 cleat 240
 cleaver 68
 clementine 126
 client 38, 175, 180
 cliff 285
 climber 87
 climbing frame 263
 clinic 48
 clipboard 173
 clitoris 20
 clock 62
 clock radio 70
 closed 260, 321
 clothes line 76
 clothes peg 76
 clothing 205
 cloud 287
 cloudy 286
 dove 125
 clover 297
 doves 133
 club 273
 club sandwich 155
 clubhouse 232
 clutch 200, 204
 coach 196
 coal 288
 coast 285
 coaster 150
 coastguard 217

- coat 32
 coat hanger 70
 cockatoo 293
 cockerel 185
 cockle 121
 cockpit 210
 cockroach 295
 cocktail 151
 cocktail shaker 150
 cocoa powder 148
 coconut 129
 cocoon 295
 cod 120
 coffee 144, 148, 153, 156, 184
 coffee cup 65
 coffee machine 148, 150
 coffee milkshake 149
 coffee spoon 153
 coffee table 62
 cog 206
 coin 97
 coin phone 99
 coin return 99
 cola 144
 colander 68
 cold 44, 286, 321
 cold tap 72
 cold-pressed oil 135
 collage 275
 collar 32
 collar bone 17
 colleague 24
 collection 98
 college 168
 Colombia 315
 colony 315
 colouring pencil 163
 colours 39, 274
 comb 38
 comb v 38
 combat sports 236
 combine harvester 182
 comedy 255
 comet 280
 comic 112
 commis chef 152
 commission 97
 communications 98
 commuter 208
 Comoros 317
 compact 40
 compact disc 269
 company 175
 compartment 209
 compass 165, 312, 240
 complaint 94
 complexion 41
 compliments slip 173
 compost 88
 compost heap 85
 computer 172, 176
 concealer 40
 conceive v 20
 conception 52
 concert 255, 258
 concertina file 173
 concourse 209
 concrete block 187
 concussion 46
 condensed milk 136
 conditioner 38
 condom 21
 conductor 256
 cone 164, 187
 confectioner 113
 confectionery 107, 113
 confident 25
 confused 25
 conglomerate 288
 Congo 317
 conifer 86
 connect v 177
 connection 212
 connecting tower 315
 console 269
 constellation 281
 construction 186
 consultant 49
 consultation 45
 contact lenses 51
 container 216, 311
 container port 216
 container ship 215
 continent 282, 315
 contraception 21, 52
 contraction 52
 control tower 212
 controller 269
 controls 201, 204
 convector heater 60
 convenience food 107
 convertible 199
 conveyer belt 106
 cooked meat 118, 143
 cooking 67
 coolant reservoir 202
 cooling rack 69
 co-pilot 211
 copper 289
 copy v 172
 cor anglais 257
 coral reef 285
 cordless phone 99
 core 127
 coriander 133
 cork 134
 corkscrew 150
 corn 130, 184
 corn bread 139
 corn oil 135
 cornea 51
 corner 223
 corner flag 223
 cornice 300
 corset 35
 Corsica 316
 Costa Rica 314
 costume 255
 cot 74
 cottage cheese 136
 cottage garden 84
 cotton 184, 277
 cotton balls 41
 cough 44
 cough medicine 108
 counsellor 55
 count v 165
 counter 96, 98, 100, 142, 272
 country 259, 315
 couple 24
 courgette 125
 counter 99
 courses 153
 court 226
 court case 180
 court date 180
 court officer 180
 court official 180
 courtroom 180
 courtyard 58, 84
 couscous 130
 cousin 22
 cow 185
 cow's milk 136
 crab 121, 295
 cracked wheat 130
 cradle 95
 crafts 275
 cramp 239
 cramps 44
 cranberry 127
 crane 187, 216, 292
 crash barrier 195
 crater 283
 crayfish 121
 cream 109, 137, 140, 157
 cream cheese 136
 cream pie 141
 crease 225
 credit card 96
 creel 245
 creeper 87
 crème caramel 141
 crème patisserie 140
 crêpe 155
 crescent moon 280
 crew 241
 crew hatch 281
 cricket 225, 295
 cricket ball 225
 cricketer 225
 crime 94
 criminal 181
 criminal record 181
 crisp 127
 crispbread 139, 156
 crisper 67
 crisps 113, 151
 Croatia 316
 crochet 277
 crochet hook 277
 crockery 64
 crockery and cutlery 65
 crocodile 293
 crocodile clip 167
 croissant 156
 crop 39, 183
 crops 184
 cross trainer 250
 crossbar 207, 222, 235
 cross-country skiing 247
 crow 292
 crown 50
 crucible 166
 crushed 132
 crust 139, 282
 cry v 25
 crystal healing 55
 Cuba 314
 cube 164
 cucumber 125
 cuff 32, 45
 cufflink 36
 cultivate v 91
 cultivator 182
 cumin 132
 cured 118, 159, 143
 curler 38
 curling 247
 curling tongs 38
 curly 39
 currant 129
 current account 96
 curry 158
 curry powder 132
 curtain 63, 254
 curved 165
 cushion 62
 custard 140
 customer 96, 104, 106, 152
 customer service department 175
 customer services 104
 customs 212
 customs house 216
 cut 46
 cut v 38, 79, 277
 cuticle 15
 cutlery 64
 cuts 119
 cutting 91
 cuttlefish 121
 cycle v 207
 cycle lane 206
 cycling 263
 cylinder 164
 cylinder head 202
 cymbals 257
 Cyprus 316
 Czech Republic 316
- D**
 daffodil 111
 dairy 107
 dairy farm 183
 dairy produce 136
 daisy 110, 297
 dam 300
 dance 259
 dance academy 169
 dancer 191
 dandelion 123, 297
 dandruff 39
 dark 41, 321
 darkroom 271
 dam v 277
 dartboard 273
 darts 273
 dashboard 201
 date 129, 306
 daughter 22
 daughter-in-law 22
 dawn 305
 day 305, 306
 dead ball line 221
 deadhead v 91
 deal v 273
 debit card 96
 decade 307
 decay 50
 December 306
 deciduous 86
 decimal 165
 deck 214
 deck chair 265
 decking 85
 decorating 82
 decoration 141
 decorator 82
 deep end 239
 deep fried 159
 deep sea fishing 245
 deer 291
 defence 181, 220
 defendant 181
 defender 223
 defending zone 224
 defrost v 67
 degree 169
 delay 209
 deli 107
 delicatessen 142
 delivery 52, 98
 deltoid 16
 Democratic Republic of the Congo 317
 Denmark 316
 denomination 97
 denominator 165
 dental care 108
 dental floss 50, 72
 dental hygiene 72
 dental x-ray 50
 dentist 50, 189
 dentist's chair 50
 dentures 50
 deodorant 73
 deodorants 108
 department 169
 department store 105
 departments 49
 departure lounge 213
 departures 213
 depth 165
 dermatology 49
 descaled 121
 desert 285
 desiccated 129
 designer 191, 277
 desk 162, 172
 desktop 177

- dessert 153
 desserts 140
 destination 213
 detached 58
 detective 94
 detergent 77
 deuce 230
 develop v 271
 diabetes 44
 diagonal 164
 dial v 99
 diameter 164
 diamond 273, 288
 diaphragm 19, 21
 diarrhoea 44, 109
 diary 175
 dice 272
 dictionary 163
 die v 26
 diesel 199
 diesel train 208
 difficult 321
 dig v 90, 227
 digestive 19
 digital 269
 digital camera 270
 dilation 52
 dill 133
 dimensions 165
 dimple 15
 dining car 209
 dining room 64
 dinner 64, 158
 dinner plate 65
 diopter 51
 diploma 169
 dipstick 202
 direct current 60
 direct debit 96
 directions 260
 director 254
 directory enquiries 99
 dirt bike 205
 dirty washing 76
 disabled parking 195
 discharged 48
 disconnected 99
 discuss 234
 discuss v 163
 disembark v 217
 dishwasher 66
 disinfectant solution 51
 disk 176
 dispensary 108
 disposable 109
 disposable camera 270
 disposable nappy 30
 disposable razor 73
 dissertation 169
 distance 310
 distributor 203
 district 315
 dive 239
 dive v 238
 diver 238
 diversion 195
 divide v 165
 divided by 165
 dividends 97
 divider 173, 194
 divorce 26
 Diwali 27
 DJ 179
 Djibouti 317
 do not bend v 98
 dock 214, 216
 dock v 217
 doctor 45, 189
 doctorate 169
 documentary 178
 dog 290
 dog sledding 247
 doll 75
 doll's house 75
 dolphin 290
 dome 300
 domestic flight 212
 Dominica 314
 Dominican Republic 314
 dominoes 273
 donkey 185
 door 196, 198, 209
 door chain 59
 door knob 59
 door knocker 59
 door lock 200
 doorbell 59
 doormat 59
 dormer 58
 dorsal fin 294
 dosage 109
 double 151
 double bass 256
 double bassoon 257
 double bed 71
 double cream 137
 double room 100
 double-decker bus 196
 doubles 230
 dough 138
 Dover sole 120
 down 320
 downhill skiing 247
 download v 177
 dragonfly 295
 drain 61, 72, 299
 drain cock 61
 drainage 91
 draining board 67
 draughts 272
 draw 223
 draw v 162
 drawer 66, 70, 172
 drawer unit 172
 drawing 275
 drawing pin 173
 dress 31, 34
 dressage 243
 dressed 159
 dressed chicken 119
 dressing 47, 158
 dressing gown 31, 32
 dressing table 71
 dribble v 223
 dried flowers 111
 dried fruit 156
 drill 50
 drill v 79
 drill bit 78
 drill bits 80
 drinking cup 75
 drinking fountain 262
 drinks 107, 144, 156
 drip 53
 drive v 195, 233
 driver 196
 driver's cab 208
 driver's seat 196
 driveshaft 202
 drop anchor v 217
 dropper 109, 167
 drops 109
 dropshot 230
 drown v 239
 drum 258
 drum kit 258
 drummer 258
 dry 39, 41, 130, 145, 286, 321
 dry v 76
 dry cleaners 115
 dry dock 217
 dual carriageway 195
 duck 119, 185
 duck egg 137
 duckling 185
 duffel coat 31
 dugout 229
 dumb bell 251
 dumper truck 187
 dungarees 30
 dunk v 227
 duodenum 18
 dusk 305
 dust v 77
 dust pan 77
 duster 77
 dustsheet 83
 duty-free shop 213
 duvet 71
 DVD disk 269
 DVD player 268
 dyed 39
 dynamo 207

E
 eagle 292
 ear 14
 early
 earring 36
 Earth 280, 282
 earthenware dish 69
 earthing 60
 earthquake 283
 easel 174, 274
 east 312
 East Timor 319
 Easter 27
 easy 321
 easy cook 130
 eat v 64
 eat-in 154
 eating 75
 eau de toilette 41
 eaves 58
 éclair 140
 eclipse 280
 economics 169
 economy class 211
 Ecuador 315
 eczema 44
 Edam 142
 edge 246
 editor 191
 eel 294
 egg 20
 egg cup 65, 137
 egg white 137
 eggs 137
 Egypt 317
 eight 308
 eight hundred 308
 eighteen 308
 eighteenth 309
 eighth 309
 eightieth 309
 eighty 308
 ejaculatory duct 21
 El Salvador 314
 elbow 13
 electric blanket 71
 electric drill 78
 electric guitar 258
 electric razor 73
 electric shock 46
 electric train 208
 electrical goods 105, 107
 electrician 188
 electricity 60
 electricity meter 60
 elephant 291
 eleven 308
 eleventh 309
 elm 296
 email 98, 177
 email account 177
 email address 177
 embarrassed 25
 embossed paper 83
 embroidery 277
 embryo 52
 emerald 288
 emergency 46
 emergency exit 210
 emergency lever 209
 emergency phone 195
 emergency room 48
 emergency services 94
 emigrate v 26
 emotions 25
 employee 24
 employer 24
 empty 321
 emulsion 83
 enamel 50
 encore 255
 encyclopedia 163
 end 321
 end zone 220
 endive 123
 endline 226
 endocrine 19
 endocrinology 49
 engaged/busy 99
 engaged couple 24
 engine 202, 204, 208, 210
 engine room 214
 engineering 169
 English breakfast 157
 english mustard 135
 engraving 175
 enlarge v 272
 enlargement 271
 enquiries 168
 ENT 49
 entrance 59
 entrance fee 260
 envelope 98, 173
 environment 280
 epidural 52
 epiglottis 19
 epilepsy 44
 episiotomy 52
 equals 165
 equation 165
 equator 283
 equipment 233, 238
 equipment 165
 Equatorial Guinea 317
 equity 97
 Eritrea 317
 erupt v 283
 escalator 104
 espresso 148
 essay 163
 essential oils 55
 estate 199
 estate agent 189
 estate agent's 115
 Estonia 316
 estuary 285
 Ethiopia 317
 eucalyptus 296
 Europe 316
 evening 305
 evening dress 34
 evening menu 152
 events 243, 247
 evergreen 86
 evidence 181
 examination 163
 excess baggage 212
 exchange rate 97
 excited 25
 excuse me 322
 executive 174
 exercise bike 250
 exercises 251
 exfoliate v 41
 exhaust pipe 203, 204
 exhibit v 261
 exhibition 261
 exit 210
 exit ramp 194

exosphere 286
 expectant 52
 experiment 166
 expiry date 109
 exposure 271
 extend v 251
 extension 58
 extension lead 78
 exterior 198
 extra time 223
 extraction 50
 extractor 66
 eye 14, 51, 244, 276
 eye shadow 40
 eye test 51
 eyebrow 14, 51
 eyebrow brush 40
 eyebrow pencil 40
 eyecup 269
 eyelash 14, 51
 eyelet 37
 eyelid 51
 eyeliner 40
 eyepiece 167

F

fabric 277
 fabric conditioner 76
 face 14
 face cream 73
 face mask 225
 face pack 41
 face powder 40
 face-off circle 224
 facial 41
 factory 299
 faint v 25, 44
 fair 41
 fairground 262
 fairway 232
 falcon 292
 Falkland Islands 315
 fall 237
 fall in love v 26
 Fallopian tube 20
 family 22
 famous ruin 261
 fan 60, 202
 fan belt 203
 fans 258
 far 320
 fare 197, 209
 farm 182, 183, 184
 farmer 182, 189
 farmhouse 182
 farmland 182
 farmyard 182
 fashion 277
 fast 321
 fast food 154
 fast forward 269
 fastening 37
 fat 119, 321
 fat free 137
 father 22
 father-in-law 23

fault 230
 fax 98, 172
 fax machine 172
 feather 293
 feature film 269
 February 306
 feed v 183
 feijoa 128
 female 12, 20
 feminine hygiene 108
 femur 17
 fence 85, 182, 243
 fencing 249
 feng shui 55
 fennel 122, 133
 fennel seeds 133
 fenugreek 132
 fern 86
 ferry 215, 216
 ferry terminal 216
 fertilization 20
 fertilize v 91
 fertilizer 91
 festivals 27
 fever 44
 fiancé 24
 fiancée 24
 fibre 127
 fibula 17
 field 182, 222, 228, 234
 field v 225, 229
 field hockey 224
 fifteen 308
 fifteenth 309
 fifth 309
 fiftieth 309
 fifty 308
 fifty five thousand, five hundred 309
 fifty thousand 309
 fig 129
 fighter plane 211
 figure skating 247
 Fiji 319
 filament 60
 file 81, 172, 177
 filing cabinet 172
 fill v 82
 filler 83
 fillet 119, 121
 filleted 121
 filling 50, 140, 155
 film 260, 271
 film chamber 270
 film set 179
 film spool 271
 filo pastry 140
 filter 270
 filter coffee 148
 filter paper 167
 fin 210
 finance 97
 financial advisor 97
 fingerprint 94
 finial 300
 finishing line 234
 Finland 316

fire 95
 fire alarm 95
 fire brigade 95
 fire engine 95
 fire escape 95
 fire extinguisher 95
 fire fighters 95
 fire station 95
 firelighter 266
 fireman 189
 fireplace 63
 firm 124
 first 309
 first aid 47
 first aid box 47
 first floor 104
 first night 254
 fish 107, 120, 294
 fish and chips 155
 fish farm 183
 fish slice 68
 fisherman 189
 fishhook 244
 fishing 244, 245
 fishing boat 217
 fishing permit 245
 fishing port 217
 fishing rod 244
 fishmonger 188
 fishmonger's 114, 120
 fist 15, 237
 fitness 250
 five 308
 five hundred 308
 flag 221, 232
 flageolet beans 131
 flakes 132
 flamingo 292
 flan 142
 flan dish 69
 flare 240
 flash 270
 flash gun 270
 flask 166
 flat 59, 256
 flatbread 139
 flat race 243
 flat wood bit 80
 flavoured oil 134
 flax 184
 fleece 74
 flesh 124, 127, 129
 flex v 251
 flight attendant 210
 flight number 213
 flint 288
 flipchart 174
 flip-flop 37
 flipper 239, 290
 float 238, 244
 float ball 61
 flock 183
 flood 287
 floor 58, 62, 71
 floor exercises 235
 floor plan 261
 florentine 141

floret 122
 florist 110, 188
 floss v 50
 flours 138
 flower 297
 flowerbed 85, 90
 flowering plant 297
 flowering shrub 87
 flowers 110
 flu 44
 flute 139, 257
 fly 244, 295
 fly v 211
 fly fishing 245
 flyover 194
 flysheet 266
 foal 185
 focus v 271
 focusing knob 167
 foetus 52
 fog 287
 foil 249
 folder 177
 foliage 110
 folk music 259
 follide 20
 font 177
 food 118, 130, 149
 food hall 105
 food processor 66
 foot 12, 15, 310
 football 220, 222
 football field 220
 football player 220
 football strip 31, 222
 footballer 222
 footboard 71
 footpath 262
 footstrap 241
 for 320
 forceps 53, 167
 forearm 12
 forecourt 199
 forehead 231
 forehead 14
 foreign currency 97
 foreskin 21
 forest 285
 fork 65, 88, 153, 207
 fork-lift truck 186, 216
 formal 34
 formal garden 84
 formal gardens 262
 fortieth 309
 fortnight 307
 forty 308
 forty minutes 304
 forward 222
 foul 222, 226
 foul ball 228
 foul line 229
 foundation 40
 fountain 85
 four 308
 four hundred 308
 four-door 200
 fourteen 308

fourteenth 309
 fourth 309
 four-wheel drive 199
 fox 290
 foxglove 297
 fraction 165
 fracture 46
 fragile 98
 fragranced 130
 frame 51, 62, 206, 230, 269
 frame counter 270
 France 316
 freckle 15
 free 321
 free kick 222
 free range 118
 free weights 250
 freesia 110
 free-throw line 226
 freeze 287
 freeze v 67
 freezer 67
 freight train 208
 freighter 215
 French bean 122
 french fries 154
 French Guiana 315
 French horn 257
 french mustard 135
 french pleat 39
 French toast 157
 frequency 179
 fresh 121, 127, 130
 fresh cheese 136
 fresh fruit 157
 freshwater fishing 245
 fret 258
 fretsaw 81
 Friday 306
 fridge-freezer 67
 fried 159
 fried chicken 155
 fried egg 157
 friend 24
 frieze 301
 frog 294
 from 320
 front crawl 239
 front door 58
 front wheel 196
 frontal 16
 frost 287
 froth 148
 frown 25
 frozen 121, 124
 frozen food 107
 frozen yoghurt 137
 fruit 107, 126, 128
 fruit bread 139
 fruit cake 140
 fruit farm 183
 fruit gum 113
 fruit juice 127, 156
 fruit tart 140
 fruit yoghurt 157
 fry v 67
 frying pan 69

fuel gauge 201
 fuel tank 204
 full 64, 266, 321
 full board 101
 full moon 280
 fumble 220
 funeral 26
 funnel 166, 214
 furniture shop 115
 furrow 183
 fuse 60
 fuse box 60, 203
 fuselage 210

G

gable 300
 Gabon 317
 Galapagos Islands 315
 galaxy 280
 gale 286
 galley 214
 gallon 311
 gallop 243
 galvanised 79
 Gambia 317
 game 119, 230, 273
 game show 178
 games 272
 gangway 214
 garage 58, 199, 203
 garden 84
 garden centre 115
 garden features 84
 garden pea 122
 garden plants 86
 garden styles 84
 garden tools 88
 gardener 188
 gardening 90
 gardening gloves 89
 gardens 261
 garland 111
 garlic 125, 132
 garlic press 68
 garnet 288
 garter 35
 gas burner 61
 gasket 61
 gate 85, 182, 247
 gate number 213
 gauze 47, 167
 gear lever 207
 gearbox 202, 204
 gears 206
 gearstick 201
 gel 38, 109
 gems 288
 generation 23
 generator 60
 genitals 12
 geography 162
 geometry 165
 Georgia 318
 gerbera 110
 Germany 316
 get a job v 26

get married v 26
 get up v 71
 geyser 285
 Ghana 317
 giant slalom 247
 gifts shop 114
 gill 294
 gin 145
 gin and tonic 151
 ginger 39, 125, 133
 giraffe 291
 girder 186
 girl 23
 girlfriend 24
 girth 242
 glacier 284
 gladiolus 110
 gland 19
 glass 69, 152
 glass bottle 166
 glass rod 167
 glasses 51, 150
 glassware 64
 glaze v 139
 glider 211, 248
 gliding 248
 gloss 83, 271
 glove 224, 233, 236, 246
 gloves 36
 glue 275
 glue gun 78
 gneiss 288
 go to bed v 71
 go to sleep v 71
 goal 221, 223, 224
 goal area 223
 goal line 220, 223, 224
 goalkeeper 222, 224
 goalpost 220, 222
 goat 185
 goat's cheese 142
 goat's milk 136
 goggles 238, 247
 going out 75
 gold 235, 289
 goldfish 294
 golf 232
 golf bag 233
 golf ball 233
 golf clubs 233
 golf course 232
 golf shoe 233
 golf trolley 233
 golfer 232
 gong 257
 good 321
 good afternoon 322
 good evening 322
 good morning 322
 good night 322
 goodbye 322
 goose 119, 293
 goose egg 137
 gooseberry 127
 gorge 284
 gorilla 291
 gothic 301

grade 163
 graduate 169
 graduate v 26
 graduation ceremony 169
 graft v 91
 grains 130
 gram 310
 granary bread 139
 grandchildren 23
 granddaughter 22
 grandfather 22
 grandmother 22
 grandparents 23
 grandson 22
 granite 288
 grape juice 144
 grapefruit 126
 grapeseed oil 134
 graphite 289
 grass 86, 262
 grass bag 88
 grasshopper 295
 grassland 285
 grate v 67
 grated cheese 136
 grater 68
 gratin dish 69
 gravel 88
 gravity 280
 graze 46
 greasy 39
 Greece 316
 green 129, 232, 274
 green olive 143
 green peas 131
 green salad 158
 green tea 149
 greengrocer 188
 greengrocer's 114
 greenhouse 85
 Greenland 314
 Grenada 314
 grey 39, 274
 grill v 67
 grill pan 69
 grilled 159
 grip 78
 groceries 106
 grocer's 114
 groin 12
 groom 243
 ground 132
 ground coffee 144
 ground cover 87
 ground floor 104
 groundnut oil 135
 group therapy 55
 grout 83
 guard 236
 Guatemala 314
 guava 128
 guest 64, 100
 guidebook 260
 guided tour 260
 guilty 181
 Guinea 317

Guinea-Bissau 317
 guitarist 258
 gull 292
 gum 50
 gun 94
 gutter 58, 299
 guy rope 266
 Guyana 315
 gym 101, 250
 gym machine 250
 gymnast 235
 gymnastics 235
 gynaecologist 52
 gynaecology 49
 gypsophila 110

H

haberdashery 105
 hacksaw 81
 haddock 120
 haemorrhage 46
 hail 286
 hair 14, 38
 hair dye 40
 hairband 38
 hairdresser 38, 188
 hairdresser's 115
 hairdryer 38
 hairpin 38
 hairspray 38
 hartie 39
 Haiti 314
 half an hour 304
 half board 101
 half time 223
 half-litre 311
 hall of residence 168
 halibut fillets 120
 Halloween 27
 hallway 59
 halter 243
 halter neck 35
 ham 119, 143, 156
 hammer 80
 hammer v 79
 hammock 266
 hamper 263
 hamster 290
 hamstring 16
 hand 13, 15
 hand drill 81
 hand fork 89
 hand luggage 211, 213
 hand rail 59
 hand saw 89
 hand towel 73
 handbag 37
 handbrake 203
 handcuffs 94
 handicap 233
 handkerchief 36
 handle 36, 88, 106, 187, 200, 224, 228
 handlebar 207
 handles 37
 handrail 196

handsaw 80
 handset 99
 hang v 82
 hang-glider 248
 hang-gliding 248
 hanging basket 84
 hanging file 173
 happy 25
 harbour 217
 harbour master 217
 hard 129, 321
 hard cheese 136
 hard drive 176
 hard hat 186
 hard shoulder 194
 hardboard 79
 hardware 176
 hardware shop 114
 hardwood 79
 haricot beans 131
 harness race 243
 harp 256
 harvest v 91, 183
 hat 36
 hatchback 199
 have a baby v 26
 Hawaii 314
 hay 184
 hayfever 44
 hazard 195
 hazard lights 201
 hazelnut 129
 hazelnut oil 134
 head 12, 19, 81, 230
 head v 222
 head injury 46
 head office 175
 head teacher 163
 headache 44
 headboard 70
 headlight 198, 205
 headphones 268
 headrest 200
 headsail 240
 health 44
 health centre 168
 health food shop 115
 heart 18, 119, 122, 273
 heart attack 44
 heater 60
 heater controls 201
 heather 297
 heating element 61
 heavy 321
 heavy metal 259
 hedge 85, 90, 182
 hedgehog 290
 heel 13, 15, 37
 height 165
 height bar 45
 helicopter 211
 hello 322
 helmet 95, 204, 206, 220, 224, 228
 hem 34
 hematite 289
 hen's egg 137

herb 55, 86
 herb garden 84
 herbaceous border 85
 herbal remedies 108
 herbal tea 149
 herbalism 55
 herbicide 183
 herbs 133, 134
 herbs and spices 132
 herd 183
 hexagon 164
 hi-fi system 268
 high 321
 high chair 75
 high dive 239
 high heel shoe 37
 high jump 235
 high speed train 208
 highlights 39
 hiking 263
 hill 284
 Himalayas 313
 hip 12
 hippopotamus 291
 historic building 261
 history 162
 history of art 169
 hit v 224
 hob 67
 hockey 224
 hockey stick 224
 hoe 88
 hold 215, 237
 holdall 37
 hole 232
 hole in one 233
 hole punch 173
 holiday 212
 holiday brochure 212
 holly 296
 home 58
 home delivery 154
 home entertainment 268
 home furnishings 105
 home plate 228
 homeopathy 55
 homework 163
 homogenised 137
 Honduras 314
 honeycomb 135
 honeymoon 26
 honeysuckle 297
 hood 31, 75
 hoof 242, 291
 hook 187, 276
 hoop 226, 277
 horizontal bar 235
 hormone 20
 horn 201, 204, 291
 horror film 255
 horse 185, 235, 242
 horse race 243
 horse riding 242, 263
 horseradish 125
 horseshoe 242
 hose 95
 hose reel 89

hosepipe 89
 hospital 48
 host 64
 hostess 64
 hot 124, 286, 321
 hot chocolate 144, 156
 hot dog 155
 hot drinks 144
 hot tap 72
 hot-air balloon 211
 hotel 100, 264
 hot-water bottle 70
 hour 304
 hour hand 304
 house 58
 household products 107
 hovercraft 215
 hub 206
 hubcap 202
 hull 214, 240
 human resources 175
 humerus 17
 humid 286
 hummingbird 292
 hump 291
 hundred 308
 hundred and ten 308
 hundred thousand 308
 hundredth 309
 Hungary 316
 hungry 64
 hurdles 235
 hurricane 287
 husband 22
 husk 130
 hydrant 95
 hydrofoil 215
 hydrotherapy 55
 hypnotherapy 55
 hypoallergenic 41
 hypotenuse 164

I

ice 120, 287
 ice and lemon 151
 ice bucket 150
 ice climbing 247
 ice cream 149
 ice cube 151
 ice hockey 224
 ice hockey player 224
 ice hockey rink 224
 ice maker 67
 ice-cream 137
 iced coffee 148
 iced tea 149
 ice-skate 224
 ice-skating 247
 icicle 287
 idng 141
 icon 177
 identity badge 189
 identity tag 53
 igneous 288
 ignition 200
 iguana 293

illness 44
 immigration 212
 impotent 20
 in 320
 in brine 143
 in front of 320
 in oil 143
 in sauce 159
 in syrup 159
 inbox 177
 inch 310
 incisor 50
 incubator 53
 index finger 15
 India 318
 Indian Ocean 312
 indicator 198, 204
 indigo 274
 Indonesia 319
 induce labour v 53
 industrial estate 299
 infection 44
 infertile 20
 infield 228
 inflatable dinghy 215
 information 261
 information screen 213
 in-goal area 221
 inhaler 44, 109
 injection 48
 injury 46
 ink 275
 ink pad 173
 inlet 61
 inner core 282
 inner tube 207
 inning 228
 innocent 181
 inoculation 45
 insect repellent 108, 267
 inside 320
 inside lane 194
 insomnia 71
 inspector 94
 install v 177
 instant camera 270
 instep 15
 instructions 109
 instruments 256, 258
 insulating tape 81
 insulation 61
 insulin 109
 insurance 203
 intensive care unit 48
 inter-city train 209
 intercom 59
 intercostal 16
 intercourse 20
 interest rate 96
 interior 200
 internal systems 60
 international flight 212
 internet 177
 intersection 298
 interval 254
 interviewer 179
 into 320

in-tray 172
 invertebrates 295
 investigation 94
 investment 97
 ionosphere 286
 Iran 318
 Iraq 318
 Ireland 316
 iris 51, 110
 iron 76, 109, 233, 289
 iron v 76
 ironing board 76
 island 282
 Israel 318
 Italy 316
 itinerary 260
 IUD 21
 Ivory Coast 317

J

jack 203, 273
 jacket 32, 34
 jade 288
 jam 134, 156
 Jamaica 314
 January 306
 Japan 318
 jar 134, 311
 javelin 234
 jaw 14, 17
 jazz 259
 jeans 31
 jelly bean 113
 jellyfish 295
 Jerusalem artichoke 125
 jet 288
 jet skiing 241
 jetty 217
 jeweller 188
 jeweller's 114
 jewellery 36
 jewellery box 36
 jewellery making 275
 jigsaw 78
 jigsaw puzzle 273
 jodhpurs 242
 jog on the spot 251
 jogging 251, 263
 joint 17, 119
 joker 273
 Jordan 318
 journal 168
 journalist 190
 judge 180
 judo 236
 juke 65
 juices and milkshakes 149
 juicy 127
 July 306
 jump 237, 243
 jump v 227
 jump ball 226
 junction 194
 June 306
 Jupiter 280
 jury 180

jury box 180

K

kale 123
 kangaroo 291
 karate 236
 Kaliningrad 316
 kayak 241
 Kazakhstan 318
 kebab 155, 158
 keel 214
 keep net 244
 kendo 236
 Kenya 317
 kerb 298
 kernel 122, 129, 130
 ketchup 135
 kettle 66
 kettledrum 257
 key 59, 80, 176, 207
 keyboard 172, 176, 258
 keypad 97, 99
 kick 237, 239
 kick v 221, 223
 kickboxing 236
 kickstand 207
 kid 185
 kidney 18, 119
 kilogram 310
 kilometre 310
 king 272, 273
 king prawn 121
 kippers 157
 kitchen 66, 152
 kitchen knife 68
 kitchenware 68, 105
 kitten 290
 kiwifruit 128
 knead v 138
 knee 12
 knee pad 205
 knee support 227
 kneecap 17
 knee-length 34
 knickers 35
 knife 65, 80
 knife sharpener 68, 118
 knight 272
 knitting 277
 knitting needle 277
 knock out 237
 knuckle 15
 koala 291
 kohlrabi 123
 koi carp 294
 kumquat 126
 kung fu 236
 Kuwait 318
 Kyrgyzstan 318

L

label 172
 labels 89
 labia 20
 laboratory 166

- lace 35, 37
lace bobbin 277
lace making 277
lace-up 37
lacrosse 249
lactose 137
ladder 95, 186
ladle 68
ladybird 295
lake 285
lamb 118, 185
lamp 62, 207, 217
land 282
land v 211
landing 59
landing gear 210
landing net 244
landlord 58
landscape 271, 284
landscape v 91
lane 234, 238
languages 162
Laos 318
lapel 32
laptop 175
larch 296
large 321
large intestine 18
larynx 19
last week 307
lat 16
late 305
later 304
latitude 283
Latvia 316
laugh v 25
launch 281
launch pad 281
launderette 115
laundry 76
laundry basket 76
laundry service 101
lava 283
law 169, 180
lawn 85, 90
lawn rake 88
lawnmower 88, 90
lawyer 180, 190
lawyer's office 180
laxative 109
lay the table v 64
lead singer 258
leaded 199
leaf 122, 296
leaflets 96
league 223
lean meat 118
learn v 163
leather shoe 37
leather shoes 32
leathers 205
Lebanon 318
lecture theatre 169
lecturer 169
leek 125
left 260
left field 228
left-hand drive 201
leg 12, 119
leg pad 225
leg press 251
legal advice 180
legal department 175
leggings 31
leisure 258, 254, 264
lemon 126
lemon curd 134
lemon grass 133
lemon sole 120
lemonade 144
length 165, 310
lens 270
lens (eye) 51
lens (glasses) 51
lens cap 270
lens case 51
Lesotho 317
lesson 163
let! 231
letter 98
letterbox 58, 99
letterhead 173
lettuce 123
lever 61, 150
lever arch file 173
Liberia 317
librarian 168, 190
library 168, 299
library card 168
Libya 317
licence plate 198
liquorice 113
lid 61, 66
Liechtenstein 316
life events 26
life jacket 240
life raft 240
lifeboat 214
lifebuoy 240
lifeguard 239, 265
lifeguard tower 265
lift 59, 100, 104
ligament 17
light 178, 321
light a fire v 266
light aircraft 211
light bulb 60
lighter 112
lighthouse 217
lighting 105
lightmeter 270
lightning 287
lights 94
lights switch 201
lily 110
lime 126, 296
limestone 288
limousine 199
line 244
line judge 220
line of play 233
linen 105, 277
linen basket 76
lines 165
linesman 223, 230
lingerie 35, 105
lining 32
lining paper 83
link 36
lintel 186
lion 291
lip 14
lip brush 40
lip gloss 40
lip liner 40
lipstick 40
liqueur 145
liquid 77
liquid dispenser 311
liquid measure 311
literature 162, 169
Lithuania 316
litre 311
little finger 15
little toe 15
live 60, 178
live rail 209
liver 18, 118
livestock 183, 185
living room 62
lizard 293
load v 76
loaf 139
loan 96, 168
loans desk 168
lob 230
lobby 100, 255
lobster 121, 295
lock 59, 207
lockers 239
log on v 177
loganberry 127
logo 31
loin 121
lollipop 113
long 32
long jump 235
long sight 51
long wave 179
long-grain 130
long-handled shears 88
longitude 283
loofah 73
loom 277
loose leaf tea 144
lorry 194
lorry driver 190
lose v 273
loser 273
lotion 109
lottery tickets 112
love 230
low 321
luge 247
luggage 100, 198, 213
luggage department 104
luggage hold 196
luggage rack 209
lumbar vertebrae 17
lunar module 281
lunch 64
lunch menu 152
lung 18
lunge 251
lupins 297
lure 244
Luxembourg 316
lychee 128
lymphatic 19
lyrics 259
- M**
macadamia 129
mace 132
Macedonia 316
machine gun 189
machinery 187
mackerel 120
macramé 277
Madagascar 317
magazine 112
magazines 107
magma 283
magnesium 109
magnet 167
maid service 101
mailbag 98, 190
main course 153
mains supply 60
mainsail 240
make a will v 26
make friends v 26
make the bed v 71
make-up 40
making bread 138
malachite 288
Malawi 317
Malaysia 318
Maldives 318
male 12, 21
Mali 317
mallet 78, 275
malt vinegar 135
Malta 316
malted drink 144
mammals 290
man 23
manager 24, 174
managing director 175
manchego 142
mane 242, 291
mango 128
mangosteen 128
manhole 299
manicure 41
mantelpiece 63
mantle 282
manual 200
map 195, 261
maple 296
maple syrup 134
maracas 257
marathon 234
marble 288
March 306
margarine 137
marina 217
marinated 143, 159
marine fishing 245
marjoram 133
mark v 227
market 115
marketing department 175
marmalade 134, 156
marrow 124
Mars 280
marshmallow 113
martial arts 237
martini 151
marzipan 141
mascara 40
mashed 159
masher 68
mask 189, 228, 236, 239, 249
masking tape 83
masonry bit 80
massage 54
mast 240
masters 169
mat 54, 83, 235, 271
match 230
matches 112
material 276
materials 79, 187
maternity 49
maternity ward 48
maths 162, 164
mattress 70, 74
Mauritiana 317
Mauritius 317
May 306
maybe 322
mayonnaise 135
MDF 79
meadow 285
meal 64
measles 44
measure 150, 151
measure v 310
measurements 165
measuring jug 69, 311
measuring spoon 109
meat 119
meat and poultry 106
meat tenderizer 68
meatballs 158
meathook 118
mechanic 188, 203
mechanical digger 187
mechanics 202
medals 235
media 178
medical examination 45
medication 109
medicine 109, 169
medicine cabinet 72
meditation 54
Mediterranean Sea 313
medium wave 179
meeting 174
meeting room 174
melody 259
melon 127

- memory 176
 men's clothing 32
 men's wear 105
 menstruation 20
 menu 148, 153, 154
 menubar 177
 mercury 289
 Mercury 280
 meringue 140
 mesosphere 286
 messages 100
 metacarpal 17
 metal 79
 metal bit 80
 metals 289
 metamorphic 288
 metatarsal 17
 meteor 280
 metre 310
 Mexico 314
 mica 289
 microlight 211
 microphone 179, 258
 microscope 167
 microwave oven 66
 midday 305
 middle finger 15
 middle lane 194
 midnight 305
 midwife 53
 migraine 44
 mile 310
 milk 136, 156
 milk v 183
 milk carton 136
 milk chocolate 113
 milkshake 137
 millennium 307
 millet 130
 milligram 310
 millilitre 311
 millimetre 310
 mince 119
 mineral 144
 minerals 289
 mini bar 101
 mini disk recorder 268
 minibus 197
 mini-dress 34
 mint 113, 133
 mint tea 149
 minus 165
 minute 304
 minute hand 304
 minutes 174
 mirror 40, 63, 71, 167
 miscarriage 52
 Miss 23
 missile 211
 mist 287
 mitre block 81
 mitt 228
 mittens 30
 mix v 67, 138
 mixed salad 158
 mixing bowl 66, 69
 mixing desk 179
 moat 300
 mobile 74
 mobile phone 99
 model 169, 190
 model making 275
 modelling tool 275
 modem 176
 moisturizer 41
 molar 50
 Moldova 316
 mole 14
 Monaco 316
 Monday 306
 money 97
 Mongolia 318
 monitor 172, 176
 monitor 53
 monkey 291
 monkfish 120
 monopoly 272
 monorail 208
 monsoon 287
 month 306
 monthly 307
 monument 261
 Moon 280
 moonstone 288
 moor v 217
 mooring 217
 mop 77
 morning 305
 Morocco 317
 mortar 68, 167, 187
 mortgage 96
 Moses basket 74
 mosque 300
 mosquito 295
 mosquito net 267
 moth 295
 mother 22
 mother-in-law 23
 motor 88
 motor racing 249
 motorbike 204
 motorbike racing 249
 motorcross 249
 motorway 194
 moulding 63
 mountain 284
 mountain bike 206
 mountain range 282
 mouse 176, 290
 mousse 141
 mouth 14
 mouth guard 237
 mouthwash 72
 move 273
 mow v 90
 Mozambique 317
 mozzarella 142
 MP3 player 268
 Mr 23
 Mrs 23
 mudguard 205
 muffin 140
 muffin tray 69
 mug 65
 mulch v 91
 multiply v 165
 multivitamin tablets 109
 mumps 44
 mung beans 131
 muscles 16
 museum 261
 mushroom 125
 music 162
 music school 169
 musical 255
 musical score 255
 musical styles 259
 musician 191
 mussel 121, 295
 mustard 155
 mustard seed 131
 Myanmar 318
- N**
 naan bread 139
 nail 15, 80
 nail clippers 41
 nail file 41
 nail scissors 41
 nail varnish 41
 nail varnish remover 41
 Namibia 317
 nape 13
 napkin 65, 152
 napkin ring 65
 nappy 75
 nappy rash cream 74
 narrow 321
 nation 315
 national park 261
 natural 256
 natural fibre 31
 naturopathy 55
 nausea 44
 navel 12
 navigate v 240
 near 320
 nebula 280
 neck 12, 258
 neck brace 46
 necklace 36
 neckline 34
 nectarine 126
 needle 109, 276
 needle plate 276
 needle-nose pliers 80
 needlepoint 277
 negative 271
 negative electrode 167
 negligence 35
 neighbour 24
 neoclassical 301
 Nepal 318
 nephew 23
 Neptune 280
 nerve 19, 50
 nervous 19, 25
 net 217, 222, 226, 227, 231
 net v 245
 net curtain 63
 Netherlands 316
 nettle 297
 network 176
 neurology 49
 neutral 60
 neutral zone 224
 new 321
 new moon 280
 new potato 124
 New Year 27
 New Zealand 319
 newborn baby 53
 news 178
 newsagent 112
 newspaper 112
 newsreader 179, 191
 next week 306
 nib 163
 Nicaragua 314
 nickel 289
 niece 23
 Niger 317
 Nigeria 317
 night 305
 nightdress 35
 nightie 31
 nightwear 31
 nine 308
 nine hundred 308
 nineteen 308
 nineteen hundred 307
 nineteen hundred and one 307
 nineteen ten 307
 nineteenth 309
 ninetieth 309
 ninety 308
 ninth 309
 nipple 12
 no 322
 no entry 195
 no right turn 195
 no stopping 195
 non-smoking section 152
 non-stick 69
 noodles 158
 normal 39
 north 312
 North and Central America 314
 North Korea 318
 North pole 283
 North Sea 312
 northern hemisphere 283
 Norway 316
 nose 14, 210
 nose clip 238
 noseband 242
 nosebleed 44
 nosewheel 210
 nostril 14
 notation 256
 note 97, 256
 note pad 173
 notebook 163, 172
 notes 175, 191
 notice board 173
 nougat 113
 November 306
 now 304
 nozzle 89
 number 226
 numbers 308
 numerator 165
 nurse 45, 48, 52, 189
 nursery 74
 nursing 53
 nursing bra 53
 nut 80
 nutmeg 132
 nuts 151
 nuts and dried fruit 129
 nylon 277
- O**
 oak 296
 oar 241
 oats 130
 objective lens 167
 oboe 257
 obsidian 288
 obstetrician 52
 occupations 188, 190
 occupied 321
 ocean 282
 ocean liner 215
 octagon 164
 October 306
 octopus 121, 295
 odometer 201
 oesophagus 19
 off licence 115
 offal 118
 offers 106
 office 24, 172, 174
 office block 298
 office equipment 172
 office supplies 173
 off-piste 247
 off-side 223
 oil 142, 199
 oil paints 274
 oil tank 204
 oil tanker 215
 oils 134
 oily 41
 ointment 47, 109
 okra 122
 old 321
 olive oil 134
 olives 151
 Oman 318
 omelette 158
 on time 305
 on top of 320
 oncology 49
 one 308
 one billion 309
 one million 309
 one thousand 309
 one-way 194
 one-way system 298
 onion 124

on-line 177
 onto 320
 onyx 289
 opal 288
 open 260, 321
 open sandwich 155
 open-top 260
 opera 255
 operating theatre 48
 operation 48
 operator 99
 ophthalmology 49
 opponent 236
 opposite 320
 optic 150
 optic nerve 51
 optician 51, 189
 orange 126, 274
 orange juice 148
 orangeade 144
 orbit 280
 orchestra 254, 256
 orchestra pit 254
 orchid 111
 order v 153
 oregano 133
 organic 91, 118, 122
 organic waste 61
 origami 275
 ornamental 87
 orthopaedy 49
 osteopathy 54
 ostrich 292
 otter 290
 ounce 310
 out 225, 228, 320
 out of bounds 226
 out of focus 271
 outboard motor 215
 outbuilding 182
 outdoor activities 262
 outer core 282
 outfield 229
 outlet 61
 outpatient 48
 outside 320
 outside lane 194
 out-tray 172
 oval 164
 ovary 20
 oven 66
 oven glove 69
 ovenproof 69
 over 320
 over par 233
 overalls 82
 overdraft 96
 overexposed 271
 overflow pipe 61
 overhead locker 210
 overhead projector 163
 overtake v 195
 overture 256
 ovulation 20, 52
 owl 292
 oyster 121
 ozone layer 286

P
 Pacific Ocean 312
 pack 311
 pack of cards 273
 packet 311
 packet of cigarettes 112
 pad 224
 paddle 241
 paddling pool 263
 paddock 242
 pads 53, 220
 paediatrics 49
 painkiller 109
 painkillers 47
 paint 83
 paint v 83
 paint tin 83
 paint tray 83
 painter 191
 painting 62, 261, 274
 paints 274
 pak-choi 123
 Pakistan 318
 palate 19
 palette 274
 pallet 186
 palm 15, 86, 296
 palm hearts 122
 palmtop 175
 pan 310
 pan fried 159
 Panama 314
 pancakes 157
 pancreas 18
 panda 291
 panty liner 108
 papaya 128
 paper clip 173
 paper guide 172
 paper napkin 154
 paper tray 172
 papier-maché 275
 paprika 132
 Papua New Guinea 319
 par 233
 parachute 248
 parachuting 248
 paragliding 248
 Paraguay 315
 parallel 165
 parallel bars 235
 parallelogram 164
 paramedic 94
 parcel 99
 parents 23
 park 262
 park v 195
 parking meter 195
 parmesan 142
 parole 181
 parrot 293
 parsley 133
 parsnip 125
 partner 23
 pass 226
 pass v 220, 223
 passenger 216

passenger port 216
 passion fruit 128
 Passover 27
 passport 213
 passport control 213
 pasta 158
 pastels 274
 pasteurized 137
 pasting brush 82
 pasting table 82
 pastry 140, 149
 pastry brush 69
 pasture 182
 patch 207
 patchwork: 277
 pâté 142, 156
 path 58, 85
 pathology 49
 patient 45
 patio garden 85
 pattern 276
 pause 269
 pavement 298
 pavement café 148
 paving 85
 pawn 272
 pay v 153
 pay in v 96
 pay per view channel 269
 paying-in slips 96
 payment 96
 payroll 175
 peach 126, 128
 peacock 293
 peanut 129
 peanut butter 135
 peanuts 151
 pear 127
 peas 131
 pecan 129
 pectoral 16
 pectoral fin 294
 pedal 61, 206
 pedal v 207
 pedestrian crossing 195
 pedestrian zone 299
 pedicure 41
 pediment 301
 peel v 67
 peeled prawns 120
 peeler 68
 pelican 292
 pelvis 17
 pen 163, 185
 pen holder 172
 penalty 222
 penalty area 223
 pencil 163, 275
 pencil case 163
 pencil sharpener 163
 pendant 36
 penfriend 24
 penguin 292
 peninsula 282
 penis 21
 pentagon 164
 peony 111

people 12, 16
 people carrier 199
 pepper 64, 124, 152
 peppercorn 132
 pepperoni 142
 percentage 165
 percussion 257
 perennial 86
 perfume 41
 perfumery 105
 pergola 84
 periodical 168
 perm 39
 perpendicular 165
 persimmon 128
 personal best 234
 personal CD player 269
 personal organizer 173, 175
 personal trainer 250
 Peru 315
 pesticide 89, 183
 pestle 68, 167
 pet food 107
 pet shop 115
 petal 297
 petri dish 166
 petrol 199
 petrol pump 199
 petrol station 199
 petrol tank 203
 pharmacist 108, 189
 pharynx 19
 pheasant 119, 293
 phillips screwdriver 81
 philosophy 169
 Philippines 319
 photo album 271
 photo finish 234
 photo frame 271
 photofit 181
 photographer 191
 photograph 271
 photograph v 271
 photography 270
 physical education 162
 physics 162, 169
 physiotherapy 49
 piano 256
 piccolo 257
 pick v 91
 pick and mix 113
 pickaxe 187
 pickled 159
 pickup 258
 picnic 263
 picnic bench 266
 pie 158
 pie tin 69
 piece 272
 pier 217
 pies 143
 pig 185
 pig farm 183
 pigeon 292
 pigeonhole 100
 piglet 185
 pigsty 185

pigtails 39
 Pilates 251
 pill 21, 109
 pillar 300
 pillion 204
 pillow 70
 pillowcase 71
 pilot 190, 211
 pin 60, 237, 249, 276
 pin number 96
 pin cushion 276
 pine 296
 pine nut 129
 pineapple 128
 pineapple juice 149
 pink 274
 pint 311
 pinto beans 131
 pip 128
 pipe 112, 202
 pipe cutter 81
 pipette 167
 piping bag 69
 pistachio 129
 pitch 225, 256, 266
 pitch v 229
 pitch a tent v 266
 pitcher 151, 229
 pitcher's mound 228
 pitches available 266
 pith 126
 pitta bread 139
 pizza 154
 pizza parlour 154
 place mat 64
 place setting 65
 placenta 52
 plain 285
 plain chocolate 113
 plain flour 139
 plait 39
 plane 81
 plane v 79
 planet 280, 282
 plant v 183
 plant pot 89
 plants 86, 296
 plaque 50
 plaster 47, 83
 plaster v 82
 plastic bag 122
 plastic pants 30
 plastic surgery 49
 plate 65, 283
 plateau 284
 platform 208
 platform number 208
 platform shoe 37
 platinum 289
 play 254, 269
 play v 229, 273
 player 221, 231, 273
 playground 263
 playhouse 75
 playing 75
 playpen 75
 plea 180

- please 322
 Plimsoll line 214
 plough v 183
 plug 60, 72
 plum 126
 plumb line 82
 plumber 188
 plumbing 61
 plunger 81
 plus 165
 Pluto 280
 plywood 79
 pneumatic drill 187
 poach v 67
 poached 159
 pocket 32
 pod 122
 podium 235, 256
 point 273
 poisoning 46
 poker 273
 Poland 316
 polar bear 291
 pole 245, 282
 pole vault 234
 police 94
 police car 94
 police cell 94
 police officer 94
 police station 94
 policeman 189
 polish 77
 polish v 77
 politics 169
 polo 243
 polyester 277
 pomegranate 128
 pommel 242
 pommel horse 235
 pond 85
 ponytail 39
 pool 249
 pop 259
 popcorn 255
 poplar 296
 popper 30
 poppy 297
 poppy seeds 138
 porch 58
 porch light 58
 pore 15
 pork 118
 porridge 156
 port 145, 176, 214, 216
 porter 100
 portfolio 97
 porthole 214
 portion 64
 portrait 271
 Portugal 316
 positive electrode 167
 post office 98
 postage 98
 postal code 98
 postal order 98
 postal worker 98
 postbox 99
 postcard 112
 poster 255
 poster paint 274
 postgraduate 169
 postman 98, 190
 postmark 98
 pot plant 110
 pot up v 91
 potato 124
 pot-pouri 111
 potted plant 87
 potter's wheel 275
 pottery 275
 potty 74
 pouch 291
 poultry 119
 poultry farm 183
 pound 310
 pour v 67
 powder 77, 109
 powder puff 40
 powdered milk 137
 power 60
 power cable 176
 power cut 60
 practice swing 233
 pram 75
 praying mantis 295
 pregnancy 52
 pregnancy test 52
 pregnant 52
 premature 52
 premolar 50
 prerecorded 178
 prescription 45
 present 27
 presentation 174
 presenter 178
 preservative 83
 preserved fruit 134
 press 178
 presser foot 276
 press-up 251
 pressure valve 61
 price 152, 199
 price list 154
 prickly pear 128
 primer 83
 primrose 297
 principality 315
 print 271
 print v 172
 printer 172, 176
 printing 275
 prison 181
 prison guard 181
 private bathroom 100
 private jet 211
 private room 48
 probe 50
 problems 271
 processed grains 130
 procession 27
 processor 176
 producer 254
 program 176
 programme 254, 269
 programming 178
 projector 174
 promenade 265
 propagate v 91
 propeller 211, 214
 proposal 174
 prosciutto 143
 prosecution 180
 prostate 21
 protractor 165
 proud 25
 prove v 139
 province 315
 prow 215
 prune 129
 prune v 91
 psychiatry 49
 psychotherapy 55
 public address system 209
 puck 224
 pudding rice 130
 Puerto Rico 314
 puff pastry 140
 pull up v 251
 pulp 127
 pulse 47
 pulses 130
 pumice 288
 pumice stone 73
 pump 207
 pumpkin 125
 pumpkin seed 131
 punch 237
 punch bag 237
 puncture 203, 207
 pup 290
 pupil 51, 162
 puppy 290
 purple 274
 purse 37
 pushchair 75
 putt v 233
 putter 233
 pyjamas 33
 pyramid 164
- Q**
 Qatar 318
 quadriceps 16
 quail 119
 quail egg 137
 quart 311
 quarter of an hour 304
 quarterdeck 214
 quartz 289
 quay 216
 queen 272, 273
 question 163
 question v 163
 quilt 71
 quilting 277
 quince 128
 quinoa 130
 quiver 249
- R**
 rabbit 118, 290
 raccoon 290
 race 234
 racecourse 243
 racehorse 243
 racing bike 205, 206
 racing dive 239
 racing driver 249
 rack 166
 racquet 230
 racquet games 231
 racquetball 231
 radar 214, 281
 radiator 60, 202
 radicchio 123
 radio 179, 268
 radio antenna 214
 radio station 179
 radiology 49
 radish 124
 radius 17, 164
 rafter 186
 rafting 241
 rail 208
 rail network 209
 rain 287
 rainbow 287
 rainbow trout 120
 raincoat 31, 32
 rainforest 285
 raisin 129
 rake 88
 rake v 90
 rally 230
 rally driving 249
 RAM 176
 Ramadan 26
 ramekin 69
 rap 259
 rapeseed 184
 rapeseed oil 135
 rapids 240, 284
 rash 44
 rasher 119
 raspberry 127
 raspberry jam 134
 rat 290
 rattle 74
 raw 124, 129
 ray 294
 razor blade 73
 razor-shell 121
 read v 162
 reading light 210
 reading list 168
 reading room 168
 reamer 80
 rear light 207
 rear wheel 197
 rearview mirror 198
 receipt 152
 receive v 177
 receiver 99
 reception 100
 receptionist 100, 190
 rechargeable drill 78
 record 234, 269
 record player 268
 record shop 115
 recording studio 179
 rectangle 164
 rectum 21
 recycling bin 61
 red 145, 274
 red card 223
 red eye 271
 red kidney beans 131
 red lentils 131
 red meat 118
 red mullet 120
 Red Sea 313
 reduce v 172
 reel 244
 reel in v 245
 refectory 168
 referee 222, 226
 referral 49
 reflector 50, 204, 207
 reflector strap 205
 reflexology 54
 refrigerator 67
 reggae 259
 region 315
 register 100
 registered post 98
 regulator 239
 re-heat v 154
 reiki 55
 reins 242
 relationships 24
 relatives 23
 relaxation 55
 relay race 235
 release v 245
 remote control 269
 Renaissance 301
 renew v 168
 rent 58
 rent v 58
 repair kit 207
 report 174
 reporter 179
 reproduction 20
 reproductive organs 20
 reptiles 293
 research 169
 reserve v 168
 respiratory 19
 rest 256
 restaurant 101, 152
 result 49
 resurfacing 187
 resuscitation 47
 retina 51
 retire v 26
 return 231
 return address 98
 return date 168
 rev counter 201
 reverse v 195
 reverse charge call 99
 rewind 269

- rhinoceros 291
 rhombus 164
 rhubarb 127
 rhythmic gymnastics 235
 rib 17, 119
 rib cage 17
 ribbon 27
 ribbon 39, 111, 141, 235
 ribs 155
 rice 130, 158, 184
 rice pudding 140
 rider 242
 riding boot 242
 riding crop 242
 riding hat 242
 rigging 215, 240
 right 260
 right field 229
 right-hand drive 201
 rim 206
 rind 119, 127, 136, 142
 ring 36
 ring finger 15
 ring ties 89
 rings 235
 rinse v 38, 76
 ripe 129
 rise v 139
 river 284
 road bike 206
 road markings 194
 road signs 195
 roads 194
 roadworks 187, 195
 roast 158
 roast v 67
 roasted 129
 roasting tin 69
 robe 38, 169
 rock climbing 248
 rock concert 258
 rock garden 84
 rocket 123
 rocks 284, 288
 Rocky Mountains 312
 rocco 301
 rodeo 243
 roll 139, 311
 roll v 67
 roller 83, 187
 roller blind 63
 roller coaster 262
 roller skating 249
 rollerblading 263
 rollerskate 249
 rolling pin 69
 romance 255
 Romania 316
 romper suit 30
 roof 58, 203
 roof garden 84
 roof tile 187
 roofrack 198
 rook 272
 room 58
 room key 100
 room number 100
 room service 101
 rooms 100
 root 50, 124, 296
 roots 39
 rope 248
 rose 89, 110, 145
 rosé 145
 rosemary 133
 rotor blade 211
 rotten 127
 rough 232
 round 237
 round neck 33
 roundabout 195
 route number 196
 router 78
 row 210, 254
 row v 241
 rower 241
 rowing boat 214
 rowing machine 250
 rubber 163
 rubber band 173
 rubber boots 89
 rubber ring 265
 rubber stamp 173
 rubbish bin 61, 67
 ruby 288
 ruck 221
 rudder 210, 241
 rug 63
 rugby 221
 rugby pitch 221
 rugby strip 221
 ruler 163, 165
 rum 145
 rum and coke 151
 rump steak 119
 run 228
 run v 228
 runner bean 122
 runway 212
 rush 86
 rush hour 209
 Russian Federation 318
 Rwanda 317
 rye bread 138

S
 sad 25
 saddle 206, 242
 safari park 262
 safe 228
 safety 75, 240
 safety barrier 246
 safety goggles 81, 167
 safety pin 47
 saffron 132
 sage 133
 Sahara Desert 313
 sail 241
 sailboat 215
 sailing 240
 sailor 189
 salad 149
 salamander 294
 salami 142
 salary 175
 sales assistant 104
 sales department 175
 salmon 120
 saloon 199
 salt 64, 152
 salted 121, 129, 137, 143
 San Marino 316
 sand 85, 264
 sand v 82
 sandal 37
 sandals 31
 sandcastle 265
 sander 78
 sandpaper 81, 83
 sandpit 263
 sandstone 288
 sandwich 155
 sandwich counter 143
 sanitary towel 108
 São Tomé and Príncipe 317
 sapphire 288
 sardine 120
 Sardinia 316
 satellite 281
 satellite dish 269
 satellite navigation 201
 satsuma 126
 Saturday 306
 Saturn 280
 sauce 134, 143, 155
 saucepan 69
 Saudi Arabia 318
 sauna 250
 sausage 155, 157
 sausages 118
 sauté v 67
 save v 177, 223
 savings 96
 savings account 97
 savoury 155
 saw v 79
 saxophone 257
 scaffolding 186
 scale 121, 256, 294
 scales 45, 53, 69, 98, 118, 166, 212, 293, 310
 scallop 121
 scalp 39
 scalpel 81, 167
 scan 48, 52
 scanner 106, 176
 scarecrow 184
 scared 25
 scarf 31, 36
 schist 288
 scholarship 169
 school 162, 299
 school bag 162
 school bus 196
 school uniform 162
 schoolboy 162
 schoolgirl 162
 schools 169
 science 162, 166
 science fiction 255
 scientist 190
 scissors 38, 47, 82, 188, 276
 scoop 68, 149
 scooter 205
 score 220, 256, 273
 score a goal v 223
 scoreboard 225
 scorpion 295
 scotch and water 151
 scrabble 272
 scrambled eggs 157
 scrape v 77
 scraper 82
 screen 59, 63, 97, 176, 255, 269
 screen wash 199
 screen wash reservoir 202
 screw 80
 screwdriver 80
 screwdriver bits 80
 script 254
 scrollbar 177
 scrotum 21
 scrub v 77
 scrum 221
 scuba diving 239
 sculpting 275
 sculptor 191
 sea 264, 282
 sea bass 120
 sea bream 120
 sea horse 294
 sea lion 290
 sea plane 211
 seafood 121
 seal 290
 sealant 83
 sealed jar 135
 seam 34
 seamstress 191
 search v 177
 seasonal 129
 seasons 306
 seat 61, 204, 209, 210, 242, 254
 seat back 210
 seat belt 198, 211
 seat post 206
 seating 254
 secateurs 89
 second 304, 309
 second floor 104
 second hand 304
 second-hand shop 115
 section 282
 security 212
 security bit 80
 security guard 189
 sedative 109
 sedimentary 288
 seed 122, 127, 130
 seed tray 89
 seeded bread 139
 seedless 127
 seedling 91
 seeds 88, 131
 seesaw 263
 segment 126
 self defence 237
 self-raising flour 139
 self-tanning cream 41
 semidetached 58
 semi-hard cheese 136
 seminal vesicle 21
 semi-skimmed milk 136
 semi-soft cheese 136
 semolina 130
 send v 177
 send off 223
 Senegal 317
 sensitive 41
 sentence 181
 September 306
 series 179
 serve 231
 serve v 64, 231
 server 176
 service included 152
 service line 230
 service not included 152
 service provider 177
 service line 230
 service not included 152
 service provider 177
 service vehicle 212
 serving spoon 68
 sesame seed 131
 sesame seed oil 134
 set 178, 230, 254
 set v 38
 set honey 134
 set sal v 217
 set square 165
 set the alarm v 71
 seven 308
 seven hundred 308
 seventeen 308
 seventeenth 309
 seventh 309
 seventieth 309
 seventy 308
 sew v 277
 sewing basket 276
 sewing machine 276
 sexually transmitted disease 20
 shade 41
 shade plant 87
 shallot 125
 shallow end 239
 shampoo 38
 shapes 164
 share price 97
 shares 97
 shark 294
 sharp 256
 sharpening stone 81
 shaving 73
 shaving foam 73
 shears 89
 shed 84
 sheep 185
 sheep farm 183
 sheep's milk 137
 sheet 71, 74, 241
 shelf 67, 106
 shell 129, 137, 265, 293

- shelled 129
shelves 66
sherry 145
shiatsu 54
shield 88
shin 12
ship 214
ships 215
shipyard 217
shirt 32
shock 47
shocked 25
shoe department 104
shoe shop 114
shoes 34, 37
shoot v 223, 227
shop 298
shop assistant 188
shopping 104
shopping bag 106
shopping centre 104
shops 114
short 32, 321
short sight 51
short wave 179
short-grain 130
shorts 30, 33
shot 151
shotput 234
shoulder 13
shoulder bag 37
shoulder blade 17
shoulder pad 35
shoulder strap 37
shout v 25
shovel 187
shower 72, 286
shower block 266
shower curtain 72
shower door 72
shower gel 73
shower head 72
showjumping 243
shuffle v 273
shutoff valve 61
shutter 58
shutter release 270
shutter-speed dial 270
shuttle bus 197
shuttlecock 231
shy 25
Siberia 313
Sicily 316
side 164
sideline 220
side order 153
side plate 65
side saddle 242
side street 299
sidedeck 240
side-effects 109
sideline 226, 230
Sierra Leone 317
sieve 68, 89
sieve v 91
sift v 138
sigh v 25
sightseeing 260
sign 104
signal 209
signature 96, 98
silencer 203, 204
silk 277
silo 183
silt 85
silver 235, 289
simmer v 67
Singapore 319
singer 191
single 151
single bed 71
single cream 137
single room 100
singles 230
sink 38, 61, 66
sinus 19
siren 94
sirloin steak 119
sister 22
sister-in-law 23
site manager's office 266
sit-up 251
six 308
six hundred 308
sixteen 308
sixteenth 309
sixth 309
sixty 308
skate 120, 247, 294
skate v 224
skate wings 120
skateboard 249
skateboarding 249, 263
skate 277
skeleton 17
sketch 275
sketch pad 275
skewer 68
ski 241, 246
ski boot 246
ski jump 247
ski pole 246
ski run 246
ski slope 246
ski suit 246
skier 246
skiing 246
skimmed milk 136
skin 14, 119, 128
skin care 108
skinned 121
skipping 251
skirt 30, 34
skull 17
skydiving 248
skyscraper 299, 300
slalom 247
slate 288
sledding 247
sledgehammer 187
sleeping 74
sleeping bag 267
sleeping compartment 209
sleeping mat 267
sleeping pill 109
sleepsuit 30
sleet 286
sleeve 34
sleeveless 34
slice 119, 139, 140, 230
slice v 67
sliced bread 138
slicer 139
slide 167, 263
slide v 229
sling 46
slip 35
slip road 194
slip-on 37
slippers 31
slope 284
slotted spoon 68
Slovakia 316
Slovenia 316
slow 321
slug 295
small 321
small car 199
small intestine 18
small of back 13
smash 231
smile 25
smoke 95
smoke alarm 95
smoked 118, 121, 143, 159
smoked fish 143
smoking 112
smoking section 152
snack bar 113, 148
snail 295
snake 293
snare drum 257
sneeze 44
snooker 249
snore v 71
snorkel 239
snout 293
snow 287
snowboarding 247
snowmobile 247
snowsuit 30
soak v 130
soap 73, 178
soap dish 73
soccer 222
socket 60, 80
socket wrench 80
socks 33
soda bread 139
soda water 144
sofa 62
sofabeted 63
soft 129, 321
soft cheese 136
soft drink 154
soft drinks 144
soft toy 75
software 176
softwood 79
soil 85
solar system 280
solder 79, 80
solder v 79
soldering iron 81
soldier 189
sole 15, 37
solids 164
Soloman Islands 319
soluble 109
solvent 83
Somalia 317
somersault 235
son 22
sonata 256
song 259
son-in-law 22
sorbet 141
sorrel 123
sorting unit 61
soufflé 158
soufflé dish 69
slow boom 179
sound technician 179
soundtrack 255
soup 153, 158
soup bowl 65
soup spoon 65
sour 127
sour cream 137
sourdough bread 139
south 312
South Africa 317
South Korea 318
southern hemisphere 283
Southern Ocean 313
souvenirs 260
sow v 90, 183
soya beans 131
space 280
space exploration 281
space shuttle 281
space station 281
space suit 281
spade 88, 265, 273
Spain 316
spanner 80
spare tyre 203
spark plug 203
sparkling 144
sparring 237
sparrow 292
spatula 68, 167
speaker 174, 176, 258, 268
speaker stand 268
spearfishing 245
specials 152
spectators 233
speed boating 241
speed limit 195
speed skating 247
speedboat 214
speedometer 201, 204
spell v 162
sperm 20
sphere 164
spices 132
spicy sausage 142
spider 295
spike v 90
spikes 233
spin 230
spin v 76
spin dryer 76
spinach 123
spine 17
spire 300
spirit level 80, 187
splashback 66
spleen 18
splint 47
splinter 46
split ends 39
split peas 131
spoke 207
sponge 73, 74, 83
sponge cake 140
sponge fingers 141
spool 245
spoon 65
sport fishing 245
sports 105, 220, 236, 248
sports car 198
sports field 168
sports jacket 33
sportsman 191
spotlight 259
sprain 46
spray 109
spray v 91
spray can 311
spray gun 89
spring 71, 307
spring balance 166
spring greens 123
spring onion 125
springboard 235, 238
sprinkler 89
sprinter 234
sprocket 207
spy hole 59
square 164, 272, 299
square foot 310
square metre 310
squash 231
squat 251
squid 121, 295
squirrel 290
Sri Lanka 318
St Kitts and Nevis 314
St Lucia 314
St Vincent and the
Grenadines 314
stabilisers 207
stable 185, 243
stadium 223
staff 175, 256
stage 167, 254
stages 23
stainless steel 79
stair gate 75
staircase 59
stake 90
stake v 91
stalk 122, 297

- stalls 254
 stamen 297
 stamp 98
 stamp collecting 273
 stamps 112
 stance 232
 stand 88, 205, 268
 stanley knife 82
 stapler 173
 staples 173
 star 280
 star anise 133
 starfish 295
 starfruit 128
 start school v 26
 starter 153
 starting block 234, 238
 starting line 234
 state 315
 statement 180
 stationery 105
 statuette 260
 steak 121
 steam v 67
 steam train 208
 steamed 159
 steeplechase 243
 steering wheel 201
 stem 111, 112, 297
 stencil 83
 stenographer 181
 step machine 150
 stepdaughter 23
 stepfather 23
 stepladder 82
 stepmother 23
 stepson 23
 stereo 269
 sterile 47
 stern 240
 stethoscope 45
 stew 158
 stick 224, 249
 sticks 133
 sticky tape 173
 still 144
 sting 46, 295
 stir v 67
 stir fry 158
 stirrer 150
 stirrup 242
 stitch 277
 stitch selector 276
 stitches 52
 stock broker 97
 stock exchange 97
 stockings 35
 stocks 97, 110
 stomach 18
 stomach ache 44
 stone 36, 275
 stoned fruit 126
 stop 269
 stop button 197
 stopper 166
 stopwatch 234
 store directory 104
 stork 292
 storm 287
 stout 145
 straight 39, 165
 straight on 260
 straighten v 39
 strap 35
 strapless 34
 stratosphere 286
 straw 144, 154
 strawberry 127
 strawberry milkshake 149
 stream 285
 street 298
 street corner 298
 street light 298
 street sign 298
 street stall 154
 stress 55
 stretch 251
 stretcher 94
 strike 228, 237
 string 230, 258
 string of pearls 36
 strings 256
 strip v 82
 stroke 44, 233, 239
 strokes 231
 strong 321
 strong flour 139
 stub 96
 study 63, 162
 stuffed 159
 stuffed olive 143
 stump 225
 styles 39, 239, 301
 submarine 215
 subsoil 91
 substitute 223
 substitution 223
 subtract v 165
 suburb 299
 succulent 87
 suction hose 77
 Sudan 317
 sugarcane 184
 suit 273
 sulphur 289
 sultana 129
 summer 31, 307
 summons 180
 sumo wrestling 237
 Sun 280
 sunbathe v 264
 sunbed 41
 sunblock 108, 265
 sunburn 46
 Sunday 306
 sunflower 184, 297
 sunflower oil 134
 sunflower seed 131
 sunglasses 51, 265
 sunhat 30, 265
 sunny 286
 sunrise 305
 sunroof 202
 sunscreen 108
 sunset 305
 sunshine 286
 suntan lotion 265
 supermarket 106
 supersonic jet 211
 supplement 55
 supply pipe 61
 support 187
 suppository 109
 surf 241
 surfboard 241
 surfcasting 245
 surfer 241
 surfing 241
 surgeon 48
 surgery 45, 48
 Suriname 315
 surprised 25
 suspect 94, 181
 suspenders 35
 suspension 203, 205
 swallow 292
 swamp 285
 swan 293
 Swaziland 317
 sweater 33
 sweatpants 33
 sweatshirt 33
 swede 125
 Sweden 316
 sweep v 77
 sweet 124, 127, 155
 sweet potato 125
 sweet shop 113
 sweet spreads 134
 sweet trolley 152
 sweetcorn 122
 sweets 113
 swim v 238
 swimmer 238
 swimming 238
 swimming pool 101, 238, 250
 swimsuit 238, 265
 swing v 232
 swings 263
 swiss chard 123
 switch 60
 Switzerland 316
 swivel chair 172
 sword 236
 swordfish 120, 294
 symphony 256
 synagogue 300
 synchronized swimming 239
 synthetic 31
 Syria 318
 syringe 109, 167
 syrup 109
 system 176
- T**
- tab 173
 table 64, 148
 table tennis 231
 tablecloth 64
 tack v 241, 277
 tackle 245
 tackle v 220, 223
 tackle box 244
 tadpole 294
 tae-kwon-do 236
 tag v 229
 tai chi 236
 tail 121, 210, 242, 280, 290, 294
 tail light 204
 tailbone 17
 tailgate 198
 tailor 191
 tailored 35
 tailor's 115
 tailor's chalk 276
 tailor's dummy 276
 tailplane 210
 Taiwan 319
 Tajikistan 318
 take a bath v 72
 take a shower v 72
 take notes v 163
 take off v 211
 take-away 154
 talcum powder 73
 tall 321
 tambourine 257
 tampon 108
 tan 41
 tandem 206
 tangerine 126
 tank 61
 Tanzania 317
 tap 61, 66
 tap water 144
 tape deck 268
 tape dispenser 173
 tape measure 80, 276
 target 249
 target shooting 249
 tarmac 187
 taro root 124
 tarragon 133
 Tasmania 319
 tattoo 41
 tax 96
 taxi driver 190
 taxi rank 213
 tea 144, 149, 184
 tea with lemon 149
 tea with milk 149
 teabag 144
 teacher 54, 162, 191
 teacup 65
 team 220, 229
 teapot 65
 tear 51
 teaspoon 65
 teat 75
 techniques 79, 159
 teddy bear 75
 tee 233
 teeing ground 232
 teenager 23
 tee-off v 233
 telegram 98
 telephone 99, 172
 telephone box 99
 telescope 281
 television 268
 television series 178
 television studio 178
 temperature 286
 temperature gauge 201
 temple 14, 300
 ten 308
 ten thousand 309
 tenant 58
 tend v 91
 tendon 17
 tennis 230
 tennis court 230
 tennis shoes 231
 tenon saw 81
 tent 267
 tent peg 266
 tent pole 266
 tenth 309
 tequila 145
 terminal 212
 termite 295
 terrace café 148
 terraced 58
 territory 315
 terry nappy 30
 test 49
 test tube 166
 testide 21
 text message 99
 textbook 163
 Thailand 318
 thank you 322
 Thanksgiving 27
 the day after tomorrow 307
 the day before yesterday 307
 theatre 254, 299
 theme park 262
 therapist 55
 thermal underwear 35
 thermals 267
 thermometer 45, 167
 thermosphere 286
 thermostat 61
 thesis 169
 thick 321
 thigh 12, 119
 thimble 276
 thin 321
 third 309
 thirteen 308
 thirteenth 309
 thirtieth 309
 thirty 308
 this way up 98
 this week 307
 thistle 297
 thoracic vertebrae 17
 thread 276
 thread v 277
 thread guide 276
 thread reel 276
 three 308

- three hundred 308
 three-door 200
 three-point line 226
 thriller 255
 throat 19
 throat lozenge 109
 throttle 204
 through 320
 throw 237
 throw v 221, 227, 229
 throw-in 223, 226
 thruster 281
 thumb 15
 thunder 286
 Thursday 306
 thyme 133
 thyroid gland 18
 tibia 17
 ticket 209, 213
 ticket barrier 209
 ticket inspector 209
 ticket office 209, 216
 tie 32
 tiebreak 230
 tie-pin 36
 tiger 291
 tights 35, 251
 tile 58, 272
 tile v 82
 till 106, 150
 tiller 240
 timber 187
 time 234, 304
 time out 220
 timer 166
 times 165, 261
 timetable 197, 209, 261
 timing 203
 tin 289, 311
 tinned food 107
 tip 36, 122, 246
 tissue 108
 title 168
 titles 23
 to 320
 toad 294
 toast 157
 toasted sandwich 149
 toaster 66
 tobacco 112, 184
 today 306
 toddler 30
 toe 15
 toe clip 207
 toe strap 207
 toenail 15
 toffee 113
 toggle 31
 Togo 317
 toilet 72
 toilet brush 72
 toilet roll 72
 toilet seat 72
 toiletries 41, 107
 toilets 104, 266
 toll booth 194
 tomato 125, 157
 tomato juice 144, 149
 tomato sauce 154
 tomorrow 306
 toner 41
 tongs 150, 167
 tongue 19, 37, 118
 tonic water 144
 tonne 310
 tool rack 78
 toolbox 177
 toolbelt 186
 toolbox 80
 tools 187
 tooth 50
 toothache 50
 toothbrush 72
 toothpaste 72
 top coat 83
 top dress v 90
 top tier 141
 topaz 288
 topiary 87
 topping 155
 topsoil 85
 torch 267
 tomado 287
 tortoise 293
 touch line 221
 touchdown 221
 tour bus 260
 tour guide 260
 tourer 205
 touring bike 206
 tourist 260
 tourist attraction 260
 tourist bus 197
 tourist information 261
 tourmaline 288
 tournament 233
 tow away v 195
 tow truck 203
 towards 320
 towel rail 72
 towels 73
 tower 300
 town 298
 town hall 299
 townhouse 58
 toy 75
 toy basket 75
 toys 105
 track 208, 234
 tracksuit 31, 32
 tractor 182
 traffic 194
 traffic jam 195
 traffic light 194
 traffic policeman 195
 trailer 266
 train 35, 208
 train v 91, 251
 train station 208
 trainer 37
 trainers 31, 251
 tram 196, 208
 transfer 223
 transformer 60
 transmission 202
 transplant v 91
 transport 194
 trapezium 164
 trapezius 16
 trash 177
 travel agent 190
 travel agent's 114
 travel sickness pills 109
 traveller's cheque 97
 tray 152, 154
 tray-table 210
 tread 207
 tread water v 239
 treadmill 250
 treble clef 256
 tree 86, 296
 trekking 243
 trellis 84
 tremor 283
 triangle 164, 257
 triceps 16
 trifle 141
 trim v 39, 90
 trimester 52
 trimmer 88
 Trinidad and Tobago 314
 tripod 166, 270, 281
 trolley 48, 100, 106, 208, 213
 trolley bus 196
 trombone 257
 tropic of Cancer 283
 tropic of Capricorn 283
 tropical fruit 128
 tropics 283
 troposphere 286
 troat 243
 trough 183
 trousers 32, 34
 trout 120
 trowel 89, 187
 trowel 113, 125
 trug 88
 trumpet 257
 truncheon 94
 trunk 291, 296
 trunks 238
 try 221
 t-shirt 30, 33
 tub 311
 tuba 257
 tube 311
 Tuesday 306
 tug boat 215
 tulip 111
 tumble 235
 tumble dryer 76
 tumbler 65
 tuna 120
 tune v 179
 tune the radio v 269
 tuning peg 258
 Tunisia 317
 turbocharger 203
 turf v 90
 Turkey 316
 turkey 119, 185, 293
 Turkmenistan 318
 turmeric 132
 turn 238
 turn v 79
 turn the television off v 269
 turn the television on v 269
 turnip 124
 turpentine 83
 turquoise 289
 turret 300
 turtle 293
 tusk 291
 tutu 191
 tweezers 40, 47, 167
 twelfth 309
 twelve 308
 twentieth 309
 twenty 308
 twenty minutes 304
 twenty thousand 309
 twenty-first 309
 twenty-one 308
 twenty-second 309
 twenty-third 309
 twenty-two 308
 twig 296
 twin room 100
 twine 89
 twins 23
 twist ties 89
 two 308
 two hundred 308
 two o'clock 304
 two thousand 307
 two thousand and one 307
 two-door 200
 types 199, 205
 types of buses 196
 types of camera 270
 types of farm 183
 types of plants 86
 types of fishing 245
 types of train 208
 tyre 198, 205, 206
 tyre lever 207
 tyre pressure 203
- U**
 Uganda 317
 ugli 126
 Ukraine 316
 ulna 17
 ultrasound 52
 ultraviolet rays 286
 umbilical cord 52
 umbrella 36, 233
 umbrella stand 59
 empire 225, 229, 230
 uncle 22
 unconscious 47
 uncooked meat 142
 under 320
 under par 233
 undercoat 83
 underexposed 271
- undergraduate 169
 underground map 209
 underground train 209
 underpass 194
 underwear 32, 35
 underwired 35
 uniform 94, 189
 United Arab Emirates 318
 United Kingdom 316
 United States of America 314
 universe 280
 university 299
 unleaded 199
 unpasteurised 137
 unpick v 277
 unsalted 137
 until 320
 up 320
 upper circle 254
 upset 25
 Uranus 280
 ureter 21
 urethra 20
 urinary 19
 urology 49
 Uruguay 315
 usher 255
 uterus 20, 52
 utility room 76
 Uzbekistan 318
- V**
 vacuum cleaner 77, 188
 vacuum flask 267
 vagina 20
 valance 71
 valley 284
 valve 207
 vanilla 132
 Vanuatu 319
 varnish 79, 83
 vas deferens 21
 vase 63, 111
 Vatican City 316
 vault 235, 300
 veal 118
 vegetable garden 85
 vegetable oil 135
 vegetable plot 182
 vegetables 107, 122, 124
 veggie burger 155
 veil 35
 vein 19
 venetian blind 63
 Venezuela 315
 venison 118
 vent 283
 ventouse cup 53
 Venus 280
 verdict 181
 vest 33, 35, 251
 vet 189
 vibraphone 257
 vice 78
 video game 269
 video phone 99

video recorder 269
 video tape 269
 Viet Nam 318
 viewfinder 271
 village 299
 vine 183
 vinegar 135, 142
 vineyard 183
 vintage 199
 viola 256
 violin 256
 virus 44
 visa 213
 vision 51
 visiting hours 48
 visor 205
 vitamins 108
 v-neck 33
 vocal cords 19
 vodka 145
 vodka and orange 151
 voice message 99
 volcano 283
 volley 231
 volleyball 227
 voltage 60
 volume 165, 179, 269, 311
 vomit v 44

W

waders 244
 waffles 157
 waist 12
 waistband 35
 waistcoat 33
 waiter 148, 152
 waiting room 45
 waitress 191
 wake up v 71
 walk 243
 walking boot 37
 walking boots 267
 walkway 212
 wall 58, 186, 222
 wall light 62
 wallet 37
 wallpaper 82, 177
 wallpaper v 82
 wallpaper brush 82
 wallpaper paste 82
 walnut 129
 walnut oil 134
 walrus 290
 ward 48
 wardrobe 70
 warehouse 216
 warm 286
 warm up v 251
 warrant 180
 wash v 38, 77
 washbasin 72
 washer 80
 washer-dryer 76
 washing machine 76
 wasp 295
 waste disposal 61, 266

waste disposal unit 61
 waste pipe 61
 wastebasket 172
 watch 36
 watch television v 269
 water 144, 238
 water v 90, 183
 water bottle 206, 267
 water chamber 61
 water chestnut 124
 water closet 61
 water garden 84
 water hazard 232
 water jet 95
 water plant 86
 water polo 239
 watercolour paints 274
 watercress 123
 waterfall 285
 watering 89
 watering can 89
 watermelon 127
 waterproofs 245, 267
 waterskier 241
 waterskiing 241
 watersports 241
 wave 241, 264
 wavelength 179
 wax 41
 weak 321
 weather 286
 weaving 277
 website 177
 wedding 26, 35
 wedding cake 141
 wedding dress 35
 wedding reception 26
 wedge 233
 Wednesday 306
 weed v 91
 weed killer 91
 weeds 86
 week 306
 weekend 306
 weekly 307
 weigh v 310
 weight 166, 244
 weight bar 251
 weight belt 239
 weight training 251
 wellington boots 31
 west 312
 western 255
 Western sahara 317
 wet 286, 321
 wet wipe 75, 108
 wetsuit 239
 whale 290
 wheat 130, 184
 wheel 198, 207
 wheel nuts 203
 wheelbarrow 88
 wheelchair 48
 wheelchair access 197
 whiplash 46
 whipped cream 137

whisk 68
 whisk v 67
 whiskers 290
 whisky 145
 white 39, 145, 272, 274
 white bread 139
 white chocolate 113
 white coffee 148
 white currant 127
 white flour 138
 white meat 118
 white rice 130
 white spirit 83
 whitening 120
 whole 129, 132
 whole milk 136
 wholegrain 131
 wholegrain mustard 135
 wholemeal bread 139
 wholemeal flour 138
 wicket 225
 wicket-keeper 225
 wide 321
 widescreen television 269
 width 165
 wife 22
 wig 39
 wild rice 130
 willow 296
 win v 273
 wind 241, 286
 windbreak 265
 windcheater 33
 windlass 214
 window 58, 96, 98, 177, 186, 197, 209, 210
 windpipe 18
 windscreen 198
 windscreen wiper 198
 windshield 205
 windsurfer 241
 windsurfing 241
 windy 286
 wine 145, 151
 wine glass 65
 wine list 152
 wine vinegar 135
 wing 119, 210, 293
 wing mirror 198
 wings 254
 winner 273
 winter 31, 307
 winter sports 247
 wipe v 77
 wire 79
 wire cutter 80
 wire strippers 81
 wire wool 81
 wires 60
 with 320
 withdrawal slip 96
 without 320
 witness 180
 wok 69
 wolf 290
 woman 23

womb 52
 women's clothing 34
 women's wear 105
 wood 79, 233, 275, 285
 wood glue 78
 wood shavings 78
 wooden spoon 68
 woodpecker 292
 woodstain 79
 woodwind 257
 woodworking 275
 wool 277
 work 172
 work day 306
 workbench 78
 workshop 78
 worktop 66
 world map 312
 worm 295
 worried 25
 wound 46
 wrap 155
 wrapping 111
 wreath 111
 wrench 81, 203
 wrestling 236
 wrinkle 15
 wrist 13, 15
 wristband 230
 writ 180
 write v 162

X

x-ray 48
 x-ray film 50
 x-ray machine 212
 x-ray viewer 45

Y

yacht 215, 240
 yam 125
 yard 310
 yawn v 25
 year 163, 306
 yeast 138
 yellow 274
 yellow card 223
 Yemen 318
 yes 322
 yesterday 306
 yoga 54
 yoghurt 137
 yok 137, 157
 you're welcome 322
 Yugoslavia 316

Z

Zambia 317
 zebra 291
 zero 308
 zest 126
 Zimbabwe 317
 zinc 289
 zip 277

zone 315
 zones 283
 zoo 262
 zoology 169
 zoom lens 270

agradecimentos • acknowledgments

DORLING KINDERSLEY would like to thank Tracey Miles and Christine Lacey for design assistance, Georgina Garner for editorial and administrative help, Sonia Gavira, Polly Boyd, and Cathy Meeus for editorial help, and Claire Bowers for compiling the DK picture credits.

The publisher would like to thank the following for their kind permission to reproduce their photographs:

Abbreviations key:

t=top, b=bottom, r=right, l=left, c=centre

Abode: 62; **Action Plus:** 224bc; **alamy.com:** 154t; A.T. Willett 287bcl; Michael Foyle 184bl; Stock Connection 287bcr; **Allsport/Getty Images:** 238cl; **Alvey and Towers:** 209 acr, 215bcl, 215bcr, 241cr; **Peter Anderson:** 188cbr, 271br. **Anthony Blake Photo Library:** Charlie Stebbings 114cl; John Sims 114tcl; **Andyalte:** 98tl; **apple mac computers:** 268tcr; **Arcaid:** John Edward Linden 301bl; Martine Hamilton Knight, Architects: Chapman Taylor Partners, 213cl; Richard Bryant 301br; **Argos:** 41tcl, 66cbl, 66cl, 66br, 66bcl, 69cl, 70bcl, 71t, 77tl, 269tc, 270tl; **Axiom:** Eitan Simanor 105bcr; Ian Cumming 104; Vicki Couchman 148cr; **Beken Of Cowes Ltd:** 215cbc; **Bosch:** 76tcr, 76tc, 76tcl; **Camera Press:** 27c, 38tr, 256t, 257cr; Barry J. Holmes 148tr; Jane Hanger 159cr; Mary Germanou 259bc; **Corbis:** 78b; Anna Clopet 247tr; Bettmann 181tl, 181tr; Bo Zauders 156t; Bob Rowan 152bl; Bob Winsett 247cbl; Brian Bailey 247br; Carl and Ann Purcell 162l; Chris Rainer 247ctcl; ChromoSohm Inc. 179tr; Craig Aurness 215bl; David H. Wells 249cbr; Dennis Marsico 274bl; Dimitri Lundt 236bc; Duomo 211tl; Gail Mooney 277ctcr; George Lepp 248c; Gunter Marx 248cr; Jack Fields 210b; Jack Hollingsworth 231bl; Jacqui Hurst 277cbr; James L. Amos 247bl, 191ctr, 220bcr; Jan Butchofsky 277cbc; Johnathan Blair 243cr; Jon Feingersh 153tr; Jose F. Poblete 191br; Jose Luis Pelaez Inc 153tc, 175tl; Karl Weatherly 220bl, 247tcr; Kelly Mooney Photography 259tl; Kevin Fleming 249bc; Kevin R. Morris 105tr, 243tl, 243tc; Kim Sayer 249tcr; Lynn Goldsmith 258t; Macduff Everton 231bcl; Mark Gibson 249bl; Mark L. Stephenson 249tcl; Michael Pole 115tr; Michael S. Yamashita 247ctcl; Mike King 247cbl; Neil Rabinowitz 214br; Owen Franken 112t; Pablo Corral 115bc; Paul A. Sounders 169br, 249ctcl;

Paul J. Sutton 224c, 224br; Peter Turnley 105tcr; Phil Schermeister 227b, 248tr; R. W. Jones 309; R.W. Jones 175tr; Richard Hutchings 168b; Rick Doyle 241ctr; Robert Holmes 97br, 277ctc; Roger Ressmeyer 169tr; Russ Schleipman 229; Steve Raymer 168cr; The Purcell Team 211ctr; Tim Wright 178; Vince Streano 194t; Wally McNamee 220br, 220bcl, 224bl; Yann Arhous-Bertrand 249tl; **Demetrio Carrasco / Dorling Kindersley (c) Herge / Les Editions Casterman:** 112ccl; **Dixons:** 270cl, 270cr, 270bl, 270bcl, 270bcr, 270ccr; **Education Photos:** John Walmsley 26tl; **Empics Ltd:** Adam Day 236br; Andy Heading 243c; Steve White 249cbc; **Getty Images:** 48bcl, 100t, 114bcr, 154bl, 287tr; 94tr; **Dennis Gilbert:** 106tc; **Hulsta:** 70t; **Ideal Standard Ltd:** 72r; **The Image Bank/Getty Images:** 58; **Impact Photos:** Eliza Armstrong 115cr; John Arthur 190tl; Philip Achache 246t; **The Interior Archive:** Henry Wilson, Alfie's Market 114bl; Luke White, Architect: David Mikhail, 59tl; Simon Upton, Architect: Philippe Starck, St Martins Lane Hotel 100bcr, 100br; **Jason Hawkes Aerial Photography:** 216t; **Dan Johnson:** 26cbl, 35r; **Kos Pictures Source:** 215cbl, 240tc, 240tr; David Williams 216b; **Lebrecht Collection:** Kate Mount 169bc; **MP Visual.com:** Mark Swallow 202t; **NASA:** 280cr, 280ccl, 281tl; **P&O Princess Cruises:** 214bl; **P A Photos:** 181br; **The Photographers' Library:** 186bl, 186bc, 186t; **Plain and Simple Kitchens:** 66t; **Powerstock Photolibrary:** 169tl, 256t, 287tc; **Rail Images:** 208c, 208 cbl, 209br; **Red Consultancy:** Odeon cinemas 257br; **Redferns:** 259br; Nigel Crane 259c; **Rex Features:** 106br, 259tc, 259tr, 259bl, 280b; Charles Ommaney 114tcr; J.F.F Whitehead 243cl; Patrick Barth 101tl; Patrick Frilet 189cbl; Scott Wiseman 287bl; **Royalty Free Images:** Getty Images/Eyewire 154bl; **Science & Society Picture Library:** Science Museum 202b; **Skyscan:** 168t, 182c, 298; Quick UK Ltd 212; **Sony:** 268bc; **Robert Streeter:** 154br; **Neil Sutherland:** 82tr, 83tl, 90t, 118, 188ctr, 196tl, 196tr, 299cl, 299bl; **The Travel Library:** Stuart Black 264t; **Travellex:** 97cl; **Vauxhall:** Technik 198t, 199tl, 199tr, 199cl, 199cr, 199ctcl, 199ctcr, 199tcl, 199tcr, 200; **View Pictures:** Dennis Gilbert, Architects: ACDP Consulting, 106t; Dennis Gilbert, Chris Wilkinson Architects, 209tr; Peter Cook, Architects: Nicholas Crimshaw and partners,

208t; **Betty Walton:** 185br; **Colin Walton:** 2, 4, 7, 9, 10, 28, 42, 56, 92, 95c, 99tl, 99tcl, 102, 116, 120t, 138t, 146, 150t, 160, 170, 191ctcl, 192, 218, 252, 260br, 260l, 261tr, 261c, 261cr, 271cbl, 271cbr, 271ctcl, 278, 287br, 302, 401.

DK PICTURE LIBRARY:

Akhil Bahkshi; Patrick Baldwin; Geoff Brightling; British Museum; John Bulmer; Andrew Butler; Joe Cornish; Brian Cosgrove; Andy Crawford and Kit Houghton; Philip Dowell; Alistair Duncan; Gables; Bob Gathany; Norman Hollands; Kew Gardens; Peter James Kindersley; Vladimir Kozlik; Sam Lloyd; London Northern Bus Company Ltd; Tracy Morgan; David Murray and Jules Selmes; Musée Vivant du Cheval, France; Museum of Broadcast Communications; Museum of Natural History; NASA; National History Museum; Norfolk Rural Life Museum; Stephen Oliver; RNLi; Royal Ballet School; Guy Rycart; Science Museum; Neil Setchfield; Ross Simms and the Winchcombe Folk Police Museum; Singapore Symphony Orchestra; Smart Museum of Art; Tony Souter; Erik Svensson and Jeppe Wikstrom; Sam Tree of Keygrove Marketing Ltd; Barrie Watts; Alan Williams; Jerry Young.

Additional Photography by Colin Walton.

Colin Walton would like to thank: A&A News, Uckfield; Abbey Music, Tunbridge Wells; Arena Mens Clothing, Tunbridge Wells; Burrells of Tunbridge Wells; Gary at Di Marco's; Jeremy's Home Store, Tunbridge Wells; Noakes of Tunbridge Wells; Ottakar's, Tunbridge Wells; Selby's of Uckfield; Sevenoaks Sound and Vision; Westfield, Royal Victoria Place, Tunbridge Wells.

All other images are Dorling Kindersley copyright. For further information see www.dkimages.com