

**Qasem Shahin**  
**Independent Sales Representative**  
Hunain Medical SM-Office - CI-13246 Free Zone .United Arab Emirates.  
<http://hunainmed.webs.com>  
Whatsapp, Viber, IMO, Telegram : TEL +962780540013  
Whatsapp, BTOM , IMO : UAE +971552122304  
TELE-FAX: 0012487155958

# PRODUCT CATALOG

IMAGING SOLUTIONS



**Qasem Shahin**

**Independent Sales Representative**

Hunain Medical SM-Office - CI-13246 Free Zone .United Arab Emirates.

<http://hunainmed.webs.com>

Whatsapp, Viber, IMO, Telegram : TEL +962780540013

Whatsapp, BTDM , IMO : UAE +971552122304

TELE-FAX: 0012487155958

**Qasem Shahin**

**Independent Sales Representative**

Hunain Medical SM-Office - CI-13246 Free Zone .United Arab Emirates.

<http://hunainmed.webs.com>

Whatsapp, Viber, IMO, Telegram : TEL +962780540013

Whatsapp, BTOM , IMO : UAE +971552122304

TELE-FAX: 0012487155958

## General Information



Corporate Headquarters  
1678 S. Pioneer Road  
Salt Lake City, UT 84104  
Tel: (801) 972 5000

3235 Fortune Drive  
North Charleston, SC 29418  
Tel: (800) 468 3729  
Tel: (843) 767 3005  
[Replacement.CS@VarexImaging.com](mailto:Replacement.CS@VarexImaging.com)

### ASIA

China - Wuxi Sales & Service  
Varex Imaging Equipment (China) Ltd.  
Company Limited - Building G,  
Plainvim International Industry Park No, 30  
Wanquan Road Xishan District, Wuxi,  
Jiangsu, China, 214100  
Tel: (86) 510 859 29201  
[China.replacement.CS@VarexImaging.com](mailto:China.replacement.CS@VarexImaging.com)

Korea Sales  
SC Jaeil Bank Bldg. 20F  
47 Jongro, Jongno-Gu, Seoul, Korea, 03160  
Tel: (82) 2 2076 8219  
[Korea.replacement.CS@VarexImaging.com](mailto:Korea.replacement.CS@VarexImaging.com)

### EMEIA

Germany Sales & Service  
Karl-Arnold-Straße 12  
D-47877 Willich, Germany  
Tel: (49) 2154 92 49 80  
[EMEIA.replacement.CS@VarexImaging.com](mailto:EMEIA.replacement.CS@VarexImaging.com)

Netherlands Connect & Control Sales  
Anholtseweg 44, 7091 HB Dinxperlo  
P.O. box 44, 7090 AA Dinxperlo  
The Netherlands  
Tel: (31) 315 659 150  
[Netherlands.replacement.CS@VarexImaging.com](mailto:Netherlands.replacement.CS@VarexImaging.com)

Italy Sales  
Viale Oriano 6  
24047 Treviglio (bg) Italy  
Tel: (39) 0363 45393  
[Italy.replacement.CS@VarexImaging.com](mailto:Italy.replacement.CS@VarexImaging.com)

India Sales  
Varex Imaging International India Pvt Ltd  
Unit No.33, Kalpataru Square,  
Off Andheri kurla Road,  
Andheri (East), Mumbai-400059 India  
Tel: (91) 22 6785 2210/2222  
[India.replacement.CS@VarexImaging.com](mailto:India.replacement.CS@VarexImaging.com)

## ORDERING INFORMATION

To place an order, contact your local sales office by phone or email. All contact information can be found on page 3 of this catalog. Varex requires confirmation of all orders in writing. For orders outside the United States, please advise final destination, special shipment instructions, customer requirements, and any necessary regulatory requirements (i.e. CE mark).

When ordering a radiographic tube, please specify:

- Application
- Housing, horn angle (high voltage cable receptacle angle)
- Paint Color
- Trunion rings, air circulator, heat exchanger, interface collimator kits
- Stator type
- Stator and heat exchanger cable length
- Collimator/interface kit may also be required

## TERMS

Net 30 days from date of invoice with approved credit. Shipping and insurance charges are additional, Ex-Works Factory. Appropriate Varex Imaging Terms and Conditions of Sale apply.

## RESTOCK

Varex will accept tubes for restocking provided they meet original specifications and are returned in original cartons via air prepaid. A twenty percent (20%) restocking charge will be deducted from any credit issued to cover the cost of testing and handling. Prior to shipment, contact the factory or service station where original tube was ordered for authorization to return for restock. Requests must be made no more than 30 days from date of shipment.

## CONSERVATION

In the interest of conservation of scarce materials, and efficient utilization of high value parts, products may contain remanufactured parts. Such parts are subject to the same high standards of quality control applied to other parts and are covered by a standard warranty.

## TUBE DISPOSAL

Please be aware of the environment and dispose of X-ray tubes in accordance with applicable regulations. It is recommended that failed tubes be returned to the manufacturer or an appropriate facility to ensure proper handling. All tubes returned to Varex for disposal will be handled in a manner that safeguards neighboring communities and the global environment.



**Qasem Shahin**

**Independent Sales Representative**

Hunain Medical SM-Office - CI-13246 Free Zone .United Arab Emirates.

<http://hunainmed.webs.com>

Whatsapp, Viber, IMD, Telegram : TEL +962780540013

Whatsapp, BTDM , IMD : UAE +971552122304

TELE-FAX: 0012487155958

## General Information

### WARRANTY/RETURNS

All products returned to Varex must have a Return Authorization (RA) number clearly marked on the packaging and shipping documents. Product must be returned within 60 days of receiving an RA number in order to be eligible for warranty credit.

To request an RA number, please complete the online form at [VarexImaging.com/support-services](http://VarexImaging.com/support-services) or send an email to [Replacement.CS@VarexImaging.com](mailto:Replacement.CS@VarexImaging.com).

For sales or customer service support, contact your local sales office by phone or email. All contact information can be found on page 3 of this catalog.

### TRADEMARKS

All trademarks property of the respective OEM's.

**Qasem Shahin**

**Independent Sales Representative**

Hunain Medical SM-Office - CI-13246 Free Zone .United Arab Emirates.

<http://hunainmed.webs.com>

Whatsapp, Viber, IMO, Telegram : TEL +962780540013

Whatsapp, BTOM , IMO : UAE +971552122304

TELE-FAX: 0012487155958

**Qasem Shahin**  
**Independent Sales Representative**  
Hunain Medical SM-Office - CI-13246 Free Zone .United Arab Emirates.  
<http://hunainmed.webs.com>  
Whatsapp, Viber, IMO, Telegram : TEL +962780540013  
Whatsapp, BTOM , IMO : UAE +971552122304  
TELE-FAX: 0012487155958

# COMPUTED TOMOGRAPHY





2

# Computed Tomography (CT)

Qasem Shahin  
 Independent Sales Representative  
 Hunain Medical SM-Office - CI-13246 Free Zone .United Arab Emirates.  
<http://hunainmed.webs.com>  
 Whatsapp, Viber, IMO, Telegram : TEL +962780540013  
 Whatsapp, BTOM , IMO : UAE +971552122304  
 TELE-FAX: 0012487155958

	Varex Tube	OEM Tube	OEM Scanner Type	Heat Units	Warranty
Elscent	GS-1584*	GS-1584	Select CT	1.5 MHU	50k
	GS-1587	GS-1587	Excel 1800 Sprint Excel 2000 Sprint	1.5 MHU	50k
	GS-3077	GS-3077	CT-Twin Helicat	3.5 MHU	300k
	GS-5079	GS-5079	CT-Twin Helicat Flash RTF	5.0 MHU	300k
* Heat exchanger (HE 350) ordered separately					
General Electric	GS-270	MX-100CT	CT-Max Sytec 1600/1800	600 kHU	40k
	GS-1562	MX115	Sytec 2000/3000/4000/i	1.5 MHU	80k
	GS-2176 	Jupiter	HiLight Advantage	2.0 MHU	80k
	GS-2176 	Mini Venus	Sytec SRI	2.0 MHU	80k
	GS-2276 	MX135 CT-H1	ProSpeed A/I, CT/e	2.0 MHU	80k

	Varex Tube	OEM Tube	OEM Scanner Type	Heat Units	Warranty
General Electric	GS-3576HS	MX165 Zeus	Hi Speed Advantage, Hi Speed CT/I	3.5 MHU	120k
	GS-3576PS	MX165 QJ	ProSpeed	3.5 MHU	120k
	GS-3576S	MX165NP Solarix	Solarix DX/i, FX/i, LX/i	3.5 MHU	120k
					
	GS-3576S	Solarix 350	BrightSpeed	3.5 MHU	150k
					
MCS-6074*		Performix	LightSpeed Plus BrightSpeed	6.3 MHU	12 mo
		Performix BrightSpeed			
		Performix Pro			
		Performix Ultra			
MCS-8064*		MX 240	LightSpeed VCT	8.0 MHU	12 mo
		Hercules	LightSpeed Xtra		
		VCT Pro	LightSpeed Pro		
			Discovery VCT		
			Optima 580		

\* May not include all scanner types

# Computed Tomography (CT)

**Qasem Shahin**  
**Independent Sales Representative**  
 Hunain Medical SM-Office - CI-1324G Free Zone .United Arab Emirates.  
<http://hunainmed.webs.com>  
**Whatsapp, Viber, IMO, Telegram : TEL +962780540013**  
**Whatsapp, BTOM , IMO : UAE +971552122304**  
**TELE-FAX: 0012487155958**

	Varex Tube	OEM Tube	OEM Scanner Type	Heat Units	Warranty
Marconi Picker	GS-5076	CTR1762RGQ, CTR1790RGQ	Picker 5.0 PQ Series	5.0 MHU	100k
Neusoft	GS-5076 (R)	CTR 1725	NeuView	5.0 MHU	100k
	GS-5076 (Q)	CTR 1740	NeuViz Dual	5.0 MHU	150k
Philips	GS-2072	GS-2072	Tomoscan AV-Pf Tomoscan SR4000	2.0 MHU	60k
	GS-3070	GS-3070	Tomoscan SR5000	3.5 MHU	60k
	GS-3072	GS-3070	Tomoscan SR6000	3.5 MHU	60k
	GS-5076R	CTR 1725	MX-4000	5.0 MHU	100k
	GS-5076Q	CTR 1740	MX-6000 Dual	5.0 MHU	150k
	GS-5172	CTR 2150	Brilliance 6, Brilliance 16, MX-16	5.2 MHU	200k
	GS-532B	Dura Akron B	MX-8000	5.32 MHU	150k
	GS-532Q	Dura Akron Q	MX-8000, Brilliance 6	5.32 MHU	120k
Shimadzu	GS-1585	GS-1585	SCT 3000, SCT 4000, SCT 4800TF	1.5 MHU	40k
	GS-2075	GS-2075	SCT 5000I, SCT 6800, SCT 7000TC, SCT 7000TH, SCT 7000TS	2.0 MHU	60k
	GS-2075A	GS-2075A	SCT 5000I, SCT 6800, SCT 7000TC, SCT 7000TH, SCT 7000TS	2.0 MHU	60k
	GS-3075A	GS-3075A	SCT 7000TS, SCT 7800T, SCT 7000TX, SCT 7800TF, SCT 7800TE	3.5 MHU	100k

**Qasem Shahin**  
**Independent Sales Representative**  
Hunain Medical SM-Office - CI-13246 Free Zone .United Arab Emirates.  
<http://hunainmed.webs.com>  
Whatsapp, Viber, IMO, Telegram : TEL +962780540013  
Whatsapp, BTOM , IMO : UAE +971552122304  
TELE-FAX: 0012487155958

# RADIOGRAPHIC/FLUOROSCOPY





3



# Radiographic/Fluoroscopy

**Qasem Shahin**  
**Independent Sales Representative**  
 Hunain Medical SM-Office - CI-13246 Free Zone .United Arab Emirates.  
<http://hunainmed.webs.com>  
**Whatsapp, Viber, IMO, Telegram : TEL +962780540013**  
**Whatsapp, BTOM , IMO : UAE +971552122304**  
**TELE-FAX: 0012487155958**

	Housing	Insert Type	Focal Spot	kW Rating	Target		Heat Units
					Angle	Size	
Varex	Diamond 	RAD-8	1.0-2.0	25/47	16°	3"	150 kHU
		RAD-12	0.6-1.2	22/54	12°	3"	150 kHU
		RAD-74	0.6-1.5	19.8/52	14°	3"	200 kHU
		RAD-68	1.0-2.0	54/96	14°	3"	300 kHU
		RAD-68	0.6-1.2	29/64	14°	3"	300 kHU
		RAD-13	1.0-2.0	39/81	16°	3"	300 kHU
	Leo 	RAD-14	0.6-1.2	32/77	12°	3"	300 kHU
		RAD-14	0.3-1.2	7.5/77	12°	3"	300 kHU
		RAD-14	0.6-1.5	32/95	12°	3"	300 kHU
		A-132*	0.6-1.2	32/76	12°	3"	300 kHU
		A-142*	0.3-1.0	9/70	10°	3"	300 kHU
	Sapphire 	A-145*	0.3-0.6	6/25	10°	3"	300 kHU
		RAD-21	0.6-1.2	36/100	12°	4"	300 kHU
		RAD-56	0.6-1.0	31/62	14°	4"	400 kHU
		RAD-56	0.6-1.2	31/85	14°	4"	400 kHU
RAD-60		0.6-1.2	40/100	12°	4"	400 kHU	
RAD-92		0.6-1.2	40/100	12°	4"	600 kHU	
		RAD-94	0.4-0.8	15/45.5	14°	4"	600 kHU

\* Available in Diamond housing only

	Housing	Insert Type	Focal Spot	kW Rating	Target		Heat Units
					Angle	Size	
Varex	B-130H 	A-192	0.6-1.2	40/100	12°	4"	300 kHU
		A-197	0.3-0.8	11/49	12°	4"	300 kHU
		A-195	0.6-1.25	40/100	12°	4"	350 kHU
		A-196	0.6-1.0	32/72	12°	4"	350 kHU
		A-256	0.6-1.0	28/54	16°	4"	400 kHU
		A-272	0.3-0.6	15/48	7°	4"	400 kHU
		A-277	0.6-1.0	48/90	7°	4"	400 kHU
		A-282	0.3-1.0	13/90	10°	4"	400 kHU
		A-286	0.3-1.2	8.5/100	12°	4"	400 kHU
		A-292	0.6-1.2	40/100	12°	4"	400 kHU
		RAD-60	0.6-1.2	40/100	12°	4"	400 kHU
		RAD-92	0.6-1.2	40/100	12°	4"	600 kHU
	G-256	0.6-1.0	28/54	16°	4"	600 kHU	
	G-292	0.6-1.2	40/100	12°	4"	600 kHU	
	G-295	1.0-1.8	45/90	12°	4"	600 kHU	
	G-296	0.6-1.0	32/72	12°	4"	600 kHU	
	G-297	0.3-0.8	12/49	12°	4"	600 kHU	
	G-892	0.6-1.2	40/100	12°	4"	857 kHU	
	G-896	0.6-1.0	32/72	12°	4"	857 kHU	
		B-130HM	G-692	0.6-1.2	40/100	12°	4"
		G-696	0.6-1.0	32/72	12°	4"	600 kHU
	B-146HM 	G-692	0.6-1.2	40/100	12°	4"	600 kHU
		G-696	0.6-1.0	32/72	12°	4"	600 kHU
		G-256	0.6-1.0	28/54	16°	4"	600 kHU
		G-292	0.6-1.2	40/100	12°	4"	600 kHU
		G-295	1.0-1.8	45/90	12°	4"	600 kHU
		G-296	0.6-1.0	32/72	12°	4"	600 kHU
		G-297	0.3-0.8	12/49	12°	4"	600 kHU
	B-147H	G-892	0.6-1.2	40/100	12°	4"	857 kHU
		G-896	0.6-1.0	32/72	12°	4"	857 kHU

## Radiographic/Fluoroscopy

	OEM Housing	Varex Housing	Insert Type	Focal Spot	KW Rating	Target Angle	Target Size	Heat Units
Comet	DX71H/HS	OEM	RAD-13	1.0-2.0	39/81	16°	3"	300 kHU
	DX81H/HS	OEM	RAD-14	0.6-1.2	32/77	12°	3"	300 kHU
	DX91H/HS	OEM	RAD-13	1.0-2.0	39/81	16°	3"	300 kHU
	DX93H/HS	OEM	RAD-14	0.6-1.5	32/95	12°	3"	300 kHU
	DX96H/HS	OEM	RAD-14	0.6-1.2	32/77	12°	3"	300 kHU
	DX96H/HS	OEM, Sapphire	RAD-21	0.6-1.2	36/100	12°	4"	300 kHU
	DX97H/HS	OEM	RAD-14	0.6-1.2	32/77	12°	3"	300 kHU
	DX97H/HS	OEM, Sapphire	RAD-21	0.6-1.2	36/100	12°	4"	300 kHU
	DX101H/HS	OEM, Sapphire	RAD-21	0.6-1.2	36/100	12°	4"	300 kHU
	DX101H/HS	OEM	A-196	0.6-1.0	32/72	12°	4"	350 kHU
	DX104H/HS	OEM	A-196	0.6-1.0	32/72	12°	4"	350 kHU
	DX104H/HS	OEM, Sapphire	RAD-60	0.6-1.2	40/100	12°	4"	400 kHU
	DX106H/HS	OEM, Sapphire	RAD-92	0.6-1.2	40/100	12°	4"	600 kHU
	DX304H/HS	OEM	A-292	0.6-1.2	40/100	12°	4"	400 kHU
Dunlee	PX1351	OEM, Diamond	RAD-8	1.0-2.0	25/47	16°	3"	150 kHU
	PX1312	OEM, Diamond	A-132	0.6-1.2	32/76	12°	3"	300 kHU
	PX1429	OEM, Sapphire	A-192	0.6-1.2	40/100	12°	4"	300 kHU
	DU 17/50	OEM	RAD-34	0.6-1.2	21/52	12.5°	3.5"	325 kHU
	DU 33/100	OEM	RAD-34	0.6-1.2	36/85	12.5°	3.5"	325 kHU
	DU 25/50	OEM	RAD-50	0.6-1.0	31.5/52.5	15°	3.5"	325 kHU
	PX1482	OEM, Sapphire	A-256	0.6-1.0	28/54	16°	4"	400 kHU
PX1436	OEM, Sapphire	A-292	0.6-1.2	40/100	12°	4"	400 kHU	
General Electric	MX75/HRT	OEM	A-132	0.6-1.2	32/76	12°	3"	300 kHU
	MX100FLXR	OEM	A-195	0.6-1.25	40/100	12°	4"	350 kHU
	MX100FLXR	OEM	A-196	0.6-1.0	32/72	12°	4"	350 kHU
	MX100-09/18	OEM	A-196	0.6-1.0	32/72	12°	4"	350 kHU
	MX100-09/18	OEM	A-195	0.6-1.25	40/100	12°	4"	350 kHU
	MX100-09/18	OEM	G-292	0.6-1.2	40/100	12°	4"	600 kHU

	OEM Housing	Varex Housing	Insert Type	Focal Spot	KW Rating	Target Angle	Target Size	Heat Units
GE/CGR	S240 (MSN740)	OEM	RAD-13	1.0-2.0	39/81	16°	3"	300 kHU
	S240 (MSN742)	OEM	RAD-14	0.6-1.2	32/77	12°	3"	300 kHU
	S240 (RSN742)	OEM	CG-292	0.6-1.2	36/85	12°	3.5"	500 kHU
	S260 (RSN742)	OEM	CG-292	0.6-1.2	36/85	12°	3.5"	500 kHU
	MX120 (RSN722)	OEM	G-1092	0.6-1.2	40/100	12°	4"	1.0 MHU
Philips	RO 17/50 ROT 350/360	OEM	RAD-34	0.6-1.2	21/52	12.5°	3.5"	325 kHU
	RO 17/50 ROT 350/360	OEM	PG-292	0.6-1.2	21/52	12°	4"	500 kHU
	SRO 25/50 ROT 350/360	OEM	RAD-50	0.6-1.0	31.5/52.5	15°	3.5"	325 kHU
	SRO 25/50 ROT 350/360	OEM	PG-256	0.6-1.0	30/50	16°	4"	500 kHU
	SRO 33/100 ROT 350/360	OEM	RAD-34	0.6-1.2	36/85	12.5°	3.5"	325 kHU
	SRO 33/100 ROT 350/360	OEM	PG-292	0.6-1.2	36/85	12°	4"	500 kHU
Shimadzu	0.6/1.2P18C RX80/RX85/ RX100	OEM	RAD-21	0.6-1.2	36/100	12°	4"	300 kHU
	0.6/1.2P38C RX80/RX85/RX100	OEM	RAD-21	0.6-1.2	36/100	12°	4"	300 kHU
	0.6/1.2P38DE RX80/RX85/RX100	OEM	RAD-21	0.6-1.2	36/100	12°	4"	300 kHU
	0.6/1.2P324DK RX80/RX85/RX100	OEM	RAD-60	0.6-1.2	40/100	12°	4"	400 kHU
Siemens	OPTI/SV 150/30/50C	OEM	SG-256B	0.6-1.0	32/60	16°	4"	600 kHU
	OPTITOP 150/30/50HC	OEM	SG-296B	0.6/1.0	40/70	12°	4"	600 kHU
	OPTI/SV 150/40/82C	OEM	SG-292B	0.6-1.2	40/100	12°	4"	600 kHU
	OPTI/SV 150/40/73C	OEM	SG-296B	0.6-1.0	40/70	12°	4"	600 kHU
	OPTI/SV 150/40/80C	OEM	SG-796B	0.6-1.0	40/80	12°	4"	600 kHU
	OPTITOP 150/40/80HC	OEM	SG-1096	0.6-1.0	40/80	12°	4"	840 kHU

# Radiographic/Fluoroscopy

**Qasem Shahin**  
**Independent Sales Representative**  
 Hunain Medical SM-Office - CI-13246 Free Zone .United Arab Emirates.  
<http://hunainmed.webs.com>  
**Whatsapp, Viber, IMO, Telegram : TEL +962780540013**  
**Whatsapp, BTOM , IMO : UAE +971552122304**  
**TELE-FAX: 0012487155958**

	OEM Housing	Varex Housing	Insert Type	Focal Spot	KW Rating	Target Angle	Target Size	Heat Units
Toshiba	DRX-3724	OEM, B-130	A-192	0.6-1.2	40/100	12°	4"	300 kHU
	DRX-3635	OEM, B-130	A-197	0.3-0.8	11/49	12°	4"	300 kHU
	DRX-3725	OEM, B-130	A-286	0.3-1.2	8.5/100	12°	4"	400 kHU
	E7843X	Diamond	RAD-12	0.6-1.2	22/54	12°	3"	150 kHU
	E7833X	OR-III	RAD-99	0.3-0.6	8/22	12°	3"	300 kHU
	E7813X	Diamond	RAD-13	1.0-2.0	39/81	16°	3"	300 kHU
	E7252X	Diamond	RAD-14	0.6-1.2	32/77	12°	3"	300 kHU
	E7255X	Sapphire	RAD-21	0.6-1.2	36/100	12°	4"	300 kHU
	E7823X	Sapphire	RAD-56	0.6-1.2	31/85	14°	4"	400 kHU
	E7254X	Sapphire	RAD-60	0.6-1.2	40/100	12°	4"	400 kHU
	E7242X	Diamond	RAD-74	0.6-1.5	19.8/52	14°	3"	200 kHU
	E7239X	Diamond	RAD-8	1.0-2.0	25/47	16°	3"	150 kHU
	E7869X	Sapphire	RAD-92	0.6-1.2	40/100	12°	4"	600 kHU

X = Reverse housing  
 FX = Standard housing  
 GX = 180° housing horn angle

**Qasem Shahin**  
**Independent Sales Representative**  
Hunain Medical SM-Office - CI-13246 Free Zone .United Arab Emirates.  
<http://hunainmed.webs.com>  
Whatsapp, Viber, IMO, Telegram : TEL +962780540013  
Whatsapp, BTOM , IMO : UAE +971562122304  
TELE-FAX: 0012487155958



# MAMMOGRAPHY



4

# Mammography

**Qasem Shahin**  
 Independent Sales Representative  
 Hunain Medical SM-Office - CI-13246 Free Zone .United Arab Emirates.  
<http://hunainmed.webs.com>  
 Whatsapp, Viber, IMO, Telegram : TEL +962780540013  
 Whatsapp, BTOM , IMO : UAE +971552122304  
 TELE-FAX: 0012487155958

Housing	Insert Type	Focal Spot	KW Rating	Target Angle	Target Size	Heat Units
 B-110, B-112   B-115	M-113	0.1 - 0.3	1.32/4.9	10°/16°	3"	300 kHU
	M-113SP	0.1 - 0.3	1.32/4.9	10°/16°	3"	300 kHU
	M-147	0.1 - 0.3	1.32/5.7	10°	3"	300 kHU
	M-149	0.25	2.2*	16°	3"	300 kHU
	RAD-85S	0.1 - 0.3	0.56/3.0*	16°	4"	600 kHU

\* KW ratings: 3 phase, 60 Hz, 1/10 second

System Type	Insert Type	Focal Spot	KW Rating	Target Angle	Target Size	Heat Units	
General Electric	Senograph 500T/600T	M-151	0.1-0.3	1.0/4.0	7°/12°	2.75"	90 kHU
	Senograph 700T/800T	M-153	0.1-0.3	1.0/4.0	7°/12°	2.75"	90 kHU
	DMR/DMR+	M-152	0.1-0.3	2.5/4.1	6°/20°	2.75"	135 kHU

## Mammography Accessories

Catalog Number	Description
751269	14' Low Voltage Cable with a 90° female connector on one end and unterminated on the other end
751307	14' Low Voltage Cable with a 90° female connect on one end and a straight female connector on the other end
746405	14' High Voltage Cable, 90°/90° Terminations
746622	15' High Voltage Cable, 90°/straight Termination
IK-140	25 Micron Moly Filter
IK-141	30 Micron Moly Filter



**Qasem Shahin**  
**Independent Sales Representative**  
Hunain Medical SM-Office - CI-13246 Free Zone .United Arab Emirates.  
<http://hunainmed.webs.com>  
Whatsapp, Viber, IMO, Telegram : TEL +962780540013  
Whatsapp, BTOM , IMO : UAE +971552122304  
TELE-FAX: 0012487155958

# MOBILE C-ARM, PORTABLES, SPECIAL PROCEDURES



5

# Mobile C-Arm & Portables

**Qasem Shahin**  
**Independent Sales Representative**  
 Hunain Medical SM-Office - CI-13246 Free Zone .United Arab Emirates.  
<http://hunainmed.webs.com>  
**Whatsapp, Viber, IMO, Telegram : TEL +962780540013**  
**Whatsapp, BTOM , IMO : UAE +971552122304**  
**TELE-FAX: 0012487155958**

Mobile C-Arm Housing		Insert Type	Focal Spot	KW Rating	Target Angle	Target Size	Heat Units
Varex	B-145	A-145	0.3-0.6	6/25	10°	3"	300 kHU
	B-145	RAD-99	0.3-0.6	8/22	10°	3"	300 kHU
	OR-III	RAD-99	0.3-0.6	8/22	10°	3"	300 kHU
	OR-IIIB	RAD-99B	0.3-0.6	8/22	10°	3"	300 kHU
	B-146H	G-292	0.6-1.2	40/100	12°	4"	600 kHU
	B-146H	G-296	0.6-1.0	32/72	12°	4"	600 kHU
	B-146H	G-297	0.3-0.8	12/49	12°	4"	600 kHU
	B-146HM	G-692	0.6-1.2	40/100	12°	4"	600 kHU
	B-146HM	G-696	0.6-1.0	32/72	12°	4"	600 kHU
	B-146H	G-892	0.6-1.2	40/100	12°	4"	857 kHU
B-146H	G-896	0.6-1.0	32/72	12°	4"	857 kHU	
Portable Housing		Insert Type	Focal Spot	KW Rating	Target Angle	Target Size	Heat Units
General Electric	AMX4+	RAD-11	0.8	22	14°	3"	196 kHU
	AMX 4	RAD-10	0.75	19.8	16°	3"	300 kHU
	AMX 3	A-132	0.6	21	12°	3"	300 kHU

	Special Procedures Housing	Insert Type	Focal Spot	KW Rating	Target Angle	Target Size	Heat Units
Varex	B-160H, B-165H	G-1092	0.6-1.2	40/100	12°	4"	1.0 MHU
	B-180H, B-185H	G-1582BI	0.3 -1.0	18/112	10°	5"	1.5 MHU
	B-180H, B-185H	G-1582BI	0.6 -1.0	60/112	10°	5"	1.5 MHU
	B-180H, B-185H	G-1582TRI	0.3-0.6-1.0	18/60/112	10°	5"	1.5 MHU
	B-180H, B-185H	G-1592	0.6 -1.2	47/112	12°	5"	1.5 MHU
	B-180H, B-185H	G-1593BI	0.3-1.2	15/112	12°	5"	1.5 MHU
	B-180H, B-185H	G-1593BI	0.8-1.2	57/112	12°	5"	1.5 MHU
	B-180H, B-185H	G-1593TRI	0.3-0.8-1.2	15/57/112	12°	5"	1.5 MHU
	B-240H	G-2090BI	0.3-1.0	14/82	12°	5"	2.0 MHU
	B-240H	G-2090TRI	0.3-0.6-1.0	14/45/82	12°	5"	2.0 MHU
Siemens	Megalix 125/30/82C(G)M*	SG-1560	0.4/0.8	30/82	8°	5"	1.35 MHU
	Megalix 125/40/82CM	SG-1590BI	0.6-1.0	40/80	12°	5"	1.3 MHU
	Megalix 125/15/40/82 CGM	SG-1590TRI	0.3-0.6-1.0	15/40/80	12°	5"	1.35 MHU

\* Specify grid

# Technical Information | Three Phase & Single Phase

Insert Type	Max KVP Rating	Heat Unit Storage kWhU	Three Phase				Single Phase			
			50 Hz 2850 RPM SM/LG	60Hz 3450 RPM SM/LG	150Hz 10000 RPM SM/LG	180Hz 10000 RPM SM/LG	50 Hz 2850 RPM SM/LG	60Hz 3450 RPM SM/LG	150Hz 10000 RPM SM/LG	180Hz 10000 RPM SM/LG
A-102	150	300	24/50	26/54	38/77	40/80	N/A	21/45	N/A	N/A
A-132	150	300	19/48	21/52	30/73	32/76	N/A	N/A	N/A	N/A
A-134G	150	300	19/48	21/52	30/73	32/76	N/A	N/A	N/A	N/A
A-142	150/120	300	5.2/43	5.7/47	8.5/67	9/70	4.0/35	4.4/38	N/A	N/A
A-144G	150	300	5.2/43.5	5.7/47	8.5/67	9/70	N/A	N/A	N/A	N/A
A-145	150/120	300	5.7/22	6/25	N/A	N/A	4.5/18	5/19	N/A	N/A
A-152	150	300	34/72	37/80	53/115	58/120	N/A	N/A	N/A	N/A
A-182	150	300	7.7/54	8.4/58	12.8/85	13.5/90	N/A	N/A	N/A	N/A
A-186	150	300	4.8/58	5.3/63	8/91	8.5/100	N/A	N/A	N/A	N/A
A-192	150	300	24/58	25/63	38/91	40/100	N/A	N/A	N/A	N/A
A-195	150	350	24/58	25/63	38/91	40/100	N/A	N/A	31/78	N/A
A-196	150	350	19/43	21/48	31/68	32/72	N/A	N/A	25/59	N/A
A-197	150	300	6.3/29	7/31	10/47	11/49	N/A	N/A	N/A	N/A
A-252	150	400	35/72	37/80	55/115	58/120	N/A	N/A	46/99	N/A
A-256	150	400	16/32	18/35	26/52	28/54	N/A	N/A	21/44	N/A
A-272	150	400	8.5/28	9.5/33	14/45	15/48	N/A	N/A	10.8/37	N/A
A-274G	150	400	8.5/28	9.5/33	14/45	15/48	N/A	N/A	10.8/37	N/A
A-277	150	400	29/55	31/59	47/86	48/90	N/A	N/A	N/A	N/A
A-278	150	400	29/55	31/59	47/86	48/90	N/A	N/A	N/A	N/A
A-282	150	400	7.7/54	8.4/58	12.8/85	13.5/90	N/A	N/A	10/71	N/A
A-286	150	400	4.8/58	5.3/63	8.2/92	8.5/100	3.7/43	N/A	N/A	N/A
A-287	150	400	4.8/58	5.3/63	8.2/92	8.5/100	N/A	N/A	N/A	N/A
A-292	150	400	24/58	25/63	38/91	40/100	19/46	N/A	N/A	N/A
A-294G	150	400	24/58	25/63	38/91	40/100	19/46	N/A	N/A	N/A
A-297	150	400	6.3/29	6.8/32	10/47	11/49	N/A	N/A	N/A	N/A
A-492	150	400	24/58	25/63	38/91	40/100	N/A	N/A	N/A	N/A
A-496	150	400	19/44	21/48	30/70	32/72	N/A	N/A	N/A	N/A
CG-292	150	500	21/54	23/55	34/80	36/85	N/A	N/A	N/A	N/A
G-242	150	600	8.8/28	9.6/30.4	14.5/44	15/45	N/A	N/A	N/A	N/A
G-256	150	600	16/32	18/35	28/52	28/54	N/A	N/A	23/44	N/A
G-286	150	600	4.8/61	5.3/66	8/96	8.5/100	N/A	N/A	N/A	N/A
G-292	150	600	24/58	26/65	38/91	40/100	N/A	N/A	32/79	N/A
G-295	150	600	41/81	45/90	N/A	N/A	N/A	N/A	N/A	N/A
G-296	150	400	19/44	21/48	30/70	32/72	N/A	N/A	N/A	N/A
G-297	150	600	6.8/30	7.5/32	11.5/44	12/49	N/A	N/A	N/A	N/A
G-689	125	600	9.6/28	10.5/30.5	16/45	17/47	N/A	N/A	N/A	N/A
G-692	150	600	24/60	26/64	38/92	40/100	N/A	N/A	N/A	N/A
G-696	150	600	19/44	21/48	30/70	32/72	N/A	N/A	N/A	N/A
G-892	150	857	24/60	26/64	38/93	40/100	N/A	N/A	N/A	N/A
G-896	150	857	19/44	21/47	31/70	32/72	N/A	N/A	N/A	N/A

# Technical Information | Three Phase & Single Phase

Insert Type	Max KVP Rating	Heat Unit Storage KHU	Three Phase				Single Phase			
			50 Hz 2850 RPM SM/LG	60Hz 3450 RPM SM/LG	150Hz 10000 RPM SM/LG	180Hz 10000 RPM SM/LG	50 Hz 2850 RPM SM/LG	60Hz 3450 RPM SM/LG	150Hz 10000 RPM SM/LG	180Hz 10000 RPM SM/LG
G-1077	150	1,000	29/54	31/58	45/85	48/90	N/A	N/A	37/70	N/A
G-1078G	150	1,000	29/54	31/58	45/85	48/90	N/A	N/A	37/70	N/A
G-1080	150	1,000	31/54	34/58	50/86	53/90	N/A	N/A	42/72	N/A
G-1082	150	1,000	7.5/54	8.1/58	12/86	13/90	5.7/43	N/A	9.8/72	N/A
G-1084G	150	1,000	7.5/54	8.1/58	12/86	13/90	5.7/43	N/A	9.8/72	N/A
G-1086	150	1,000	6.8/61	7.5/66	11/95	12/100	5.3/50	N/A	9/83	N/A
G-1087G	150	1,000	6.8/61	7.5/66	11/95	12/100	5.3/50	N/A	9/83	N/A
G-1092	150	1,000	24/61	26/66	38/95	40/100	N/A	N/A	32/80	N/A
G-1094G	150	1,000	24/61	26/66	38/95	40/100	N/A	N/A	32/80	N/A
G-1582BI (0.6-1.0)	125	1,500	35/66	38/72	58/102	60/112	N/A	N/A	N/A	N/A
G-1582BI (0.3-1.0)	125	1,500	10/66	11/72	17/102	18/112	N/A	N/A	N/A	N/A
G-1582TRI	125	1,500	10/35/66	11/38/72	17/58/102	18/60/112	N/A	N/A	N/A	N/A
G-1584TRI	125	1,500	10/35/66	11/38/72	17/58/102	18/60/112	N/A	N/A	N/A	N/A
G-1592	125	1,500	27/68	31/73	46/108	47/112	N/A	N/A	N/A	N/A
G-1593BI (0.3-1.2)	125	1,500	8.5/68	9/73	14/108	15/112	N/A	N/A	N/A	N/A
G-1593BI (0.8-1.2)	125	1,500	34/68	36/73	56/105	57/112	N/A	N/A	N/A	N/A
G-1593TRI	125	1,500	8.5/34/68	9/36/73	14/56/105	15/57/112	N/A	N/A	N/A	N/A
G-2064	125	2,000	32/58	34/62	51/92	54/96	N/A	N/A	N/A	N/A
G-2090TRI	125	2,000	8.5/25/48	9.2/28/52	12/42/77	14/45/82	N/A	N/A	N/A	N/A
M-105SP	39	300	0.50/2.0	0.56/2.2	N/A	N/A	N/A	N/A	N/A	N/A
M-109	52	300	0.41/1.4	0.45/1.5	N/A	N/A	N/A	N/A	N/A	N/A
M-113	49	300	.77/2.8	.8/3.1	1.2/4.7	1.32/4.9	N/A	N/A	N/A	N/A
M-113SP	49	300	.77/2.8	.8/3.1	1.2/4.7	1.32/4.9	N/A	N/A	N/A	N/A
M-146	39	300	0.8/5.6	0.87/6.0	1.2/8.8	1.4/9.0	N/A	N/A	N/A	N/A
M-146SP	39	300	0.68/3.6	0.75/3.9	1.2/6.0	1.4/6.3	N/A	N/A	N/A	N/A
M-147	39	300	0.7/3.3	0.8/3.6	1.2/5.5	1.32/5.7	N/A	N/A	N/A	N/A
M-147SP	39	300	0.7/3.3	0.8/3.6	1.2/5.5	1.32/5.7	N/A	N/A	N/A	N/A
M-149	39	300	2	2.2	N/A	N/A	N/A	N/A	N/A	N/A
M-151	52	90	.9/3.6	1.0/4.0	N/A	N/A	N/A	N/A	N/A	N/A
M-152	49	135	N/A	N/A	N/A	Mo 2.5/5.5 Rh 2.0/4.1	N/A	N/A	N/A	N/A
M-153	49	90	N/A	N/A	N/A	1.0/4.0	N/A	N/A	N/A	N/A
PG-256	150	500	15.5/30.5	17/33	25/48	30/50	12.4/24	N/A	N/A	N/A
PG-292	150	500	21/52	23/56	34/83	36/85	17/41	N/A	34/82	N/A
RAD-4	125	300	17	18	N/A	N/A	15	16.5	N/A	N/A
RAD-8	125	150	24/45	25/47	N/A	N/A	23/42	24/43	N/A	N/A
RAD-10	150	300	18/38	19.8/41.2	N/A	N/A	N/A	N/A	N/A	N/A
RAD-11	125	196	20.4	22	N/A	N/A	N/A	N/A	N/A	N/A
RAD-12	150	150	20/46	22/54	N/A	N/A	16.5/38	17.5/41.5	N/A	N/A
RAD-13	150	300	24/50	26/55	38/77	39.2/81.2	N/A	N/A	N/A	N/A

# Technical Information | Three Phase & Single Phase

Insert Type	Max KVP Rating	Heat Unit Storage kWh	Three Phase				Single Phase			
			50 Hz 2850 RPM SM/LG	60Hz 3450 RPM SM/LG	150Hz 10000 RPM SM/LG	180Hz 10000 RPM SM/LG	50 Hz 2850 RPM SM/LG	60Hz 3450 RPM SM/LG	150Hz 10000 RPM SM/LG	180Hz 10000 RPM SM/LG
RAD-14 (0.3-1.2)	150	300	4.3/50	4.5/54	7/74	7.5/77	3.75/38	4/39	6/60	7/65
RAD-14 (0.6-1.2)	150	300	19/50	21.5/54	31/74	32/77	13.5/38	15/39	22/60	24/65
RAD-14 (0.6-1.5)	150	300	19/60	21.5/64.2	31/92	32/95	13.5/40	15/47	22/69	24/78
RAD-15	125	365	7.0/23	7.7/25	N/A	N/A	N/A	N/A	N/A	N/A
RAD-21	150	300	19/60	21/65	32/92	36/100	17/53	18/57	28/82	32/88
RAD-34	150	325	22/52	24/56	35/81	36/85	N/A	N/A	N/A	N/A
RAD-44	150	400	32/65	35/72	50/100	55/115	N/A	N/A	N/A	N/A
RAD-50	150	325	19/32	20/35	30/50	31.5/52.5	N/A	N/A	N/A	N/A
RAD-56 (0.6-1.0)	150	400	18/38	20/41	28/60	31/62	N/A	N/A	N/A	N/A
RAD-56 (0.6-1.2)	150	400	18/50	20/55	28/80	31/85	N/A	N/A	N/A	N/A
RAD-60	150	400	24/60	26/66	39/96	40/100	17/50	19/52	31/80	32/88
RAD-68 (1.0-2.0)	150	300	34/60	38/66	52/93	54/96	N/A	N/A	N/A	N/A
RAD-68 (0.6-1.2)	150	300	18/40	20/44	28/61	29.8/64	N/A	N/A	N/A	N/A
RAD-73	49	600	5.4	5.9	9.0	9.4	N/A	N/A	N/A	N/A
RAD-74	125	200	18/47.5	19.8/52	N/A	N/A	14/42.5	16/45	N/A	N/A
RAD-85S	50	300	0.5/2.8	0.56/3.0	N/A	N/A	N/A	N/A	N/A	N/A
RAD-92	150	600	24/60	26/63	36/89	40/100	N/A	N/A	N/A	N/A
RAD-94	150	600	9/28	10/28.5	13.5/42	15/45.5	N/A	N/A	N/A	N/A
RAD-99/B	125	300	7.6/21	8.3/22.8	N/A	N/A	N/A	N/A	N/A	N/A
SG-1096	150	840	24/48	26/52	39/76	40/80	N/A	N/A	N/A	N/A
SG-1560	150	1,350	18/51	N/A	30/82	N/A	N/A	N/A	N/A	N/A
SG-1590Bl	125	1,350	24.5/50	N/A	40/80	N/A	N/A	N/A	N/A	N/A
SG-1590TRI	125	1,350	9/24.5/50	N/A	15/40/80	N/A	N/A	N/A	N/A	N/A
SG-256B	150	600	18/36	20/38	30/57	32/60	N/A	N/A	N/A	N/A
SG-292B	150	600	24/60	26/66	38/96	40/100	N/A	N/A	N/A	N/A
SG-296B	150	600	24/44	26/48	38/67.5	40/70	N/A	N/A	N/A	N/A
SG-796B	150	600	24/44	26/48	38/67.5	40/70	N/A	N/A	N/A	N/A

**Qasem Shahin**  
**Independent Sales Representative**  
 Hunain Medical SM-Office - CI-13246 Free Zone .United Arab Emirates.  
<http://hunainmed.webs.com>  
**Whatsapp, Viber, IMO, Telegram : TEL +962780540013**  
**Whatsapp, BTOM , IMO : UAE +971552122304**  
**TELE-FAX: 0012487155958**

**Qasem Shahin**  
**Independent Sales Representative**  
Hunain Medical SM-Office - CI-13246 Free Zone .United Arab Emirates.  
<http://hunainmed.webs.com>  
Whatsapp, Viber, IMO, Telegram : TEL +962780540013  
Whatsapp, BTOM , IMO : UAE +971562122304  
TELE-FAX: 0012487155958

## VAREX HOUSINGS

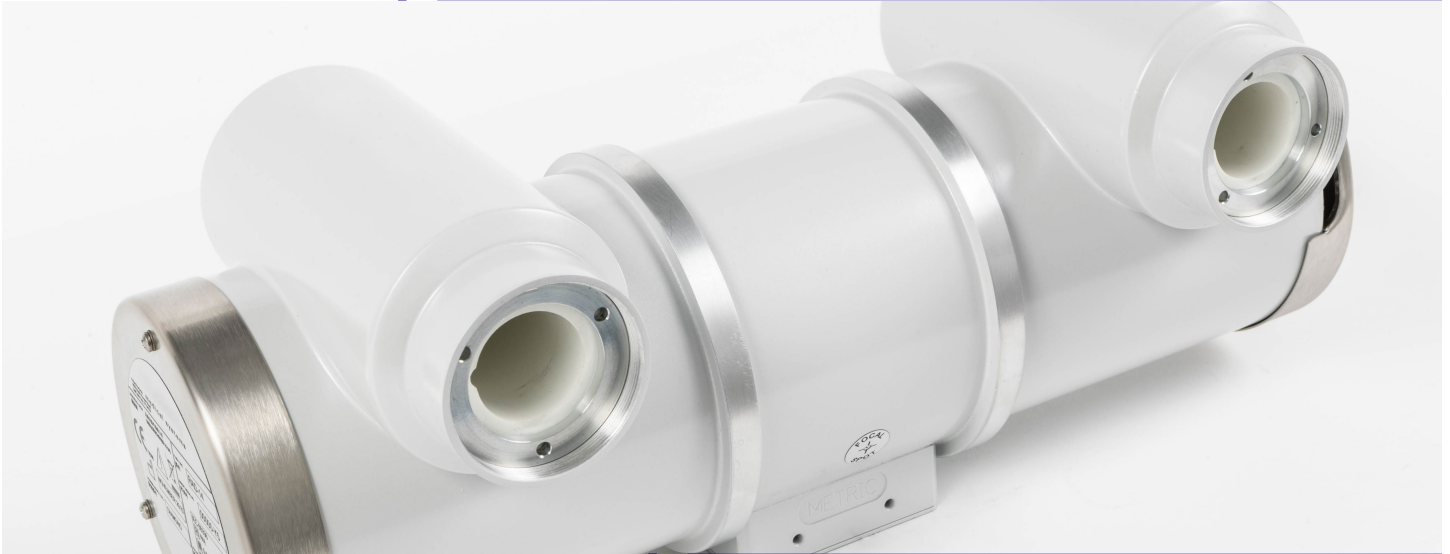

6



# Housings

**Qasem Shahin**  
**Independent Sales Representative**  
Hunain Medical SM-Office - CI-13246 Free Zone .United Arab Emirates.  
<http://hunainmed.webs.com>  
Whatsapp, Viber, IMO, Telegram : TEL +962780540013  
Whatsapp, BTOM , IMO : UAE +971552122304  
TELE-FAX: 0012487155958

B-110



B-115



B-130H



B-146H/B-146HM



B-160H, B-165H

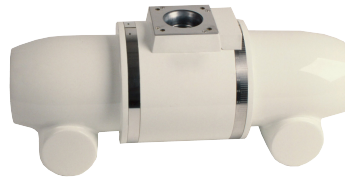

B-180, B-185H



B-240H



Diamond

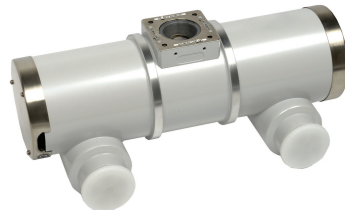

Leo



B-147



OR-III, OR-IIIB

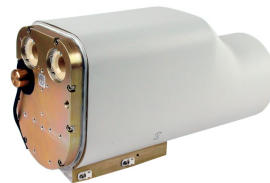

Sapphire



# HOUSING HORN ANGLES

VIEWED FROM ANODE END

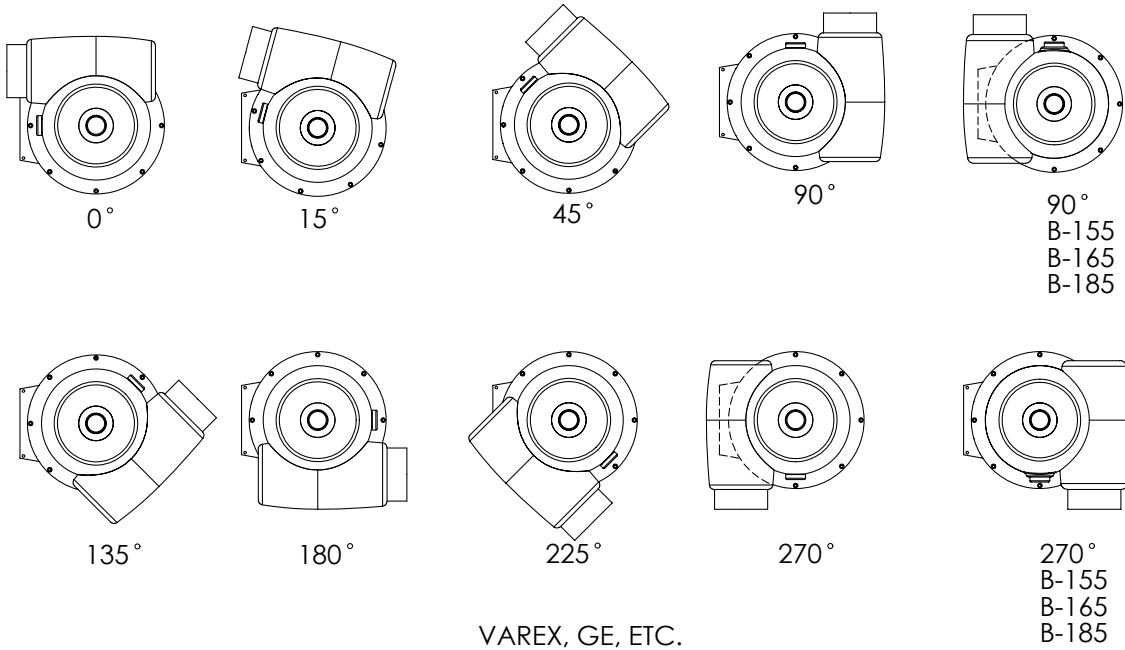

**Qasem Shahin**

**Independent Sales Representative**

Hunain Medical SM-Office - CI-1324G Free Zone .United Arab Emirates.

<http://hunainmed.webs.com>

**Whatsapp, Viber, IMO, Telegram : TEL +962780540013**

**Whatsapp, BTOM , IMO : UAE +971552122304**

**TELE-FAX: 0012487155958**

**Qasem Shahin**

**Independent Sales Representative**

Hunain Medical SM-Office - C1-13246 Free Zone .United Arab Emirates.

<http://hunainmed.webs.com>

Whatsapp, Viber, IMO, Telegram : TEL +962780540013

Whatsapp, BTOM , IMO : UAE +971552122304

TELE-FAX: 0012487155958

## X-RAY ACCESSORIES



7

## X-ray Accessories

### AEC Sensors

Ionization Chambers	Fields	Size (mm) (L x W x T)	Cable Outlet	Preamplifier
ICX136B	3	449 x 449 x 7.1	Right-top side	Attached
ICX141B	3	449 x 449 x 7.1	Left-bottom side	Remote
ICX251B	5	450 x 457 x 7.1	Left-top side	Remote
ICX945B	3	465 x 465 x 7.1	Left-bottom side	Remote
ICX967B	3	470 x 500 x 10.2	Left-top side	Internal
ICX986B	5	449 x 449 x 7.0	Right-top side	Remote
ICX1113B	3	450 x 450 x 3.5	Left-bottom side	Remote
ICX1153B	3	470 x 457 x 10.5	Right-bottom side	Attached
ICX1159B	3	475 x 457 x 10.2	Top side	Attached (90%)
ICX1162B	3	470 x 457 x 10.2	Right-bottom side	Attached
ICX2122B*	3	449 x 449 x 3.5	Left-bottom side	Remote
INX247B	3	450 x 457 x 7.1	Left-top side	Remote

\* ICX2122B available with a non-magnetic frame (ICX3122) and 12V power supply (ICX3922)

Solid State	Fields	Size (mm) (L x W x T)	Cable Outlet	Preamplifier
SSMC 501	3	460 x 472 x 3	Right-bottom side	Separate
SSMC 508	5	460 x 472 x 3	Left-bottom side	Separate
SSMC 510	3	450 x 450 x 3	Right side	Separate
SSMC 601	3	460 x 472 x 3.3	Right-bottom side	Separate
SSMC 604	1	460 x 472 x 3.3	Right-bottom side	Separate
SSMC 617	3	450 x 450 x 3.3	Right side	Separate
SSMC 701	3	133 x 102 x 5	Left-bottom side	Separate
MD100B	1	44 x 64 x 13	Left side	Separate

Preamplifiers	Fields	Size (mm) (L x W x T)	Description
AmpMC 1001	3	246 x 42 x 21	Preamplifier for 3-field solid state AEC sensors. Connector to generator is a 9-pin D-sub.
AmpMC 1007	5	281 x 42 x 15	Preamplifier for 5-field solid state AEC sensors. Selection of 3 fields (out of 5) is based upon image receptor orientation. Selection needs two signals: Portrait/Landscape and Inverted/Non-inverted. Connector to generator is a 12-pin D-sub.

Connectors				
Product	Group	Rating (kVDC)	Pins	Description
CA1	Federal Standard	100*	3	Standard connector for RAD/RF/CT tubes & generators
CA3	Mammo	60	1	Standard mammography connector
CA4	Federal Standard	100*	4	Standard connector for RAD/RF/CT tubes & generators with 4th pin for grid controlled tubes
CA7	Federal Standard	100*	4	Standard connector for RAD/RF/CT tubes & generators with 4th pin in square configuration
CA11	Mini	75	4	Miniature alternative (50% size reduction) for medical x-ray tubes
CA16	Extended Federal Standard	160	3	Extended version of CA1 for grounded anode CT tubes
CA21	Flat connector	150	3	Flat interface connector for CT tubes and generators
CA22	Rubber cone	150	3	Silicone rubber cone connector used in CT generators
CA24	Mini	75	3	Smaller and thinner than CA11 for space critical applications
CA28	Flat connector	160	3	Flat interface connector for CT tubes and generators
CA29	Mini	75	3	Conical shaped mini connector for certain OEM tubes and generators
CA45	Mini	75	4	Miniature alternative (50% size reduction) for medical x-ray tubes with smaller grounding flange For space critical applications
CA48	Extended Federal Standard	160	6	Extended version of CA1 for grounded anode CT tubes with 6 pins
CA52	Federal Standard	100*	5	Standard connector for RAD/RF/CT tubes & generators with 5 pins

\* Maximum kV to be used depends on cable type and installation method (silicone washer, grease or oil)

## X-ray Accessories

### High Voltage Cables

Product	Rating (kVDC)	Number of Conductors	Nominal Outer Diameter mm [inch]	Capacitance Core-shield pF/m
M1	60	1	11.1 [0.437]	163
L3	75	3	16.7 [0.657]	145
T4	75	4	16.7 [0.657]	226
X3	75	3	13.2 [0.520]	134
U3	100	3	20.0 [0.787]	136
L4	100	4	21.3 [0.839]	145
A5	100	5	19.3 [0.760]	154
J3	160	3	22.9 [0.902]	204
N3	160	3	29.0 [1.154]	132
N4	160	4	28.3 [1.114]	136
N6	160	6	34.0 [1.339]	159

### Receptacles

Product	Pins	Description
CA1	3	The receptacle for Federal Standard CA1 connectors
CA3	1	Most commonly used receptacle in mammography systems
CA4	4	Same as CA1 but with four pins for use in Grid controlled tubes
CA7	4	Same as CA1 but with four pins in square configuration
CA11	4	The receptacle for miniature CA11 connectors
CA28	3	The receptacle for CA28 flat connectors

Extension Cables	Connectors	Length (m)	Description
6-pin	Circular female to male	15, 20, 25	Extension cable between sensor and preamplifier For 3-field solid state AEC sensors
9-pin	D-Sub female to male	5, 10, 15, 20, 25	Extension cable between preamplifier and generator For 3-field solid state AEC sensors
12-pin	Circular female to male	15, 20, 25	Extension cable between sensor and preamplifier For 5-field solid state AEC sensors



**Collimators**

Product	Type	Body Size (mm) (W x L x H)	Weight	Power Supply	Attenuation @75kV	Operation	Light Source
Optica 20	Manual	230 x 257 x 165	8 kg	12 - 45 VDC 20 - 30 VAC	1.2 mm Al eq.	Dials	LED
Optica 30	Motorized	230 x 313 x 165	9 kg	24 VDC	1.2 mm Al eq.	Dials, CAN-bus	LED
Optica 40	Motorized	230 x 313 x 165	9 kg	24 VDC	1.2 mm Al eq.	Dials, Touchscreen, CAN-bus	LED
Optica 50	Motorized	230 x 313 x 165	9 kg	24 VDC	1.2 mm Al eq.	CAN-bus	LED

**Bucky Systems**

Harmony	Weight	Size (L x W x H)	Detector Rotation	Loading Side
Table Model	±23 kg	584 x 571 x 69 mm	Center or off-center	Left (standard)
Wall Model	±24 kg	610 x 610 x 77 mm	Center or off-center	Left/Right

## Heat Exchangers

Catalog Number	SAP Number	Description
HE-50/51	750816 750927	Heat Exchanger (oil to air) with single fan For use with B-100, B-130H, B-150H and B-160H Housings Hose lengths up to 5 feet /1.52 meters maximum 48,600 HU/min dissipation at 50° CDT
HE-100/101*	750322 750323	115/230 VAC Heat Exchanger (oil to air) quiet style For B-130H, B-150H, B-160H and B-180H Housings Hose lengths up to 40 feet/12.2 meters maximum 100,000 HU/min dissipation at 55° CDT
HE-110/111*	756214 746215	115/230 VAC Heat Exchanger (oil to air) For B-130H, B-150H, B-160H and B-180H housings Hose lengths up to 40 feet/12.2 meters maximum 93,000 HU/min dissipation at 55° CDT
HE-200/201	5478 10686	115/230 VAC Heat Exchanger (oil to water) For B-130H, B-150H, B-160H, and B-180H Hose length up to 25 feet/7.4 meters maximum Requires using HE-401 and IK-120 or IK-121
HE-320/321*	745374 745375	115/230 VAC Heat Exchanger (oil to air) For B-130H, B-150H, B-160H and B-180H Housings Hose lengths up to 40 feet/12.2 meters maximum 194,000 HU/min dissipation at 50° CDT
HE-401	1861	230 VAC water cooler, 3 kW dissipation at 50° CDT Select IK-120/IK-121 hoses
HE-420	2961	115 VAC Heat Exchanger (oil to water) Hose lengths up to 23 feet/7 Meters 243,000 HU/min (3 kW) dissipation when used with HE-401 Use with B-240H Housing only
HE-580/581	745146 745163	115/230 VAC Heat Exchanger (oil to air) For B-130H, B-150H, B-160H and B-180H Housings Hose lengths up to 40 feet/12.2 meters maximum 268,800 HU/min dissipation at 50° CDT
IK-120	751467	30 meter (97 feet) water hoses for HE-401 with QD
IK-121	751468	40 meter (130 feet) water hoses for HE-401 with QD
IK-124*	27017	HE Diaphragm Kit for hose lengths longer than 5 feet

\* Hose lengths longer than 5 ft. (1.52 meters) require IK-124 diaphragm kit

**Trunnion Rings**

Catalog Number	SAP Number*	Description
<b>DIAMOND HOUSING</b>		
55-14100	89101	Trunnion with back bar, Four 1/4" - 20 tapped holes For Liebel Flarsheim Tables, Shimadzu over table and tube stands
22-11109	89110	Trunnion with back bar, Four 6mm tapped holes For Liebel Flarsheim, Siemens, Philips and Pausch Provides 100mm mounting distance from back bar to housing center line
<b>SAPPHIRE HOUSING</b>		
25-10923	89228	Trunnion with back bar, Four 6mm tapped holes For Liebel Flarsheim, Siemens, Philips and Pausch Tube Stands Provides 100mm mounting distance from back bar to housing center line
55-19100	89350	Trunnion with back bar, Four 1/4" - 20 tapped holes For Liebel Flarsheim, Siemens, and Philips tube stands
55-73500	89240	Trunnion with back bar for Shimadzu under table use
55-73600	89241	Trunnion for Shimadzu over table use
<b>B-130H HOUSING TRUNNION RINGS</b>		
CN-132	745396	21 x 92mm hole pattern M6 metric threads
<b>B-160H HOUSING TRUNNION RINGS</b>		
CN-150	748405	Philips, CGR, Siemens, GE, Liebel Flarsheim Hydrajust Table, Ultrarad, F100 Head Stand, Xonics and Pausch
CN-163	749680	Toshiba Tube Stands
CN-166	746080	Shimadzu MH-50 C-Arm
<b>B-180H HOUSING TRUNNION RINGS</b>		
CN-170	749088	Philips, CGR, Siemens, GE, Liebel Flarsheim Hydrajust Table, Ultrarad, F100 Head Stand, Xonics and Pausch
CN-186	1361	Shimadzu MH-50 C-Arm
<b>B-200H &amp; B-240H HOUSING TRUNNION RINGS</b>		
CN-240	121090	Trunnion rings
<b>B-260H HOUSING TRUNNION RINGS</b>		
CN-200	745519	Philips, GE hole pattern

\*Catalog numbers may vary with color selection

Note: Fixed housing mounting backplates available for Diamond and B-130H housings

# NOTES

**Qasem Shahin**

**Independent Sales Representative**

Hunain Medical SM-Office - CI-13246 Free Zone .United Arab Emirates.

<http://hunainmed.webs.com>

Whatsapp, Viber, IMO, Telegram : TEL +962780540013

Whatsapp, BTOM , IMO : UAE +971552122304

TELE-FAX: 0012487155958

**Qasem Shahin**

**Independent Sales Representative**

Hunain Medical SM-Office - CI-13246 Free Zone .United Arab Emirates.

<http://hunainmed.webs.com>

Whatsapp, Viber, IMO, Telegram : TEL +962780540013

Whatsapp, BTDM , IMO : UAE +971552122304

TELE-FAX: 0012487155958

**Qasem Shahin**

**Independent Sales Representative**

Hunain Medical SM-Office - CI-1324G Free Zone .United Arab Emirates.

<http://hunainmed.webs.com>

Whatsapp, Viber, IMO, Telegram : TEL +962780540013

Whatsapp, BTOM , IMO : UAE +971552122304

TELE-FAX: 0012487155958

