



## 2K Video Doorbell DH-DB6I

- 01 Introduction
- 02 Key Features
- 03 Comparison
- 04 Product Info
- 05 Order Info

# DB61 2K Video Doorbell

## Answer the Door from Anywhere

DB61 delivers 2k live monitoring experience with a 5M sensor. It is able to capture more details with the 164° fish eye lens. DB61 supports night vision mode for clear-as day clarity even in pitch dark. With IP65 certified, the doorbell can be used outdoors under different weather conditions. The support of dual-band Wi-Fi enables DB61 to provide more Wi-Fi choice and extend the Wi-Fi connectivity. Furthermore, it is equipped with a smart night light, which can be used to notify motion detections and illuminate in the night.



**Full Color**



### 2K QHD Video Quality

Features a high quality sensor for crystal clear video.



### AI Human Detection

Only sends a mobile alert to your device when a human is detected, allowing users to monitor without receiving annoying false alerts.



### Night Vision Mode

Supports night vision for clear-as-day clarity even in pitch dark environments.



### LED Active Deterrence

Scares away unwelcome visitors with built-in LED spotlight.



### IP65 Weatherproof

Provides protection against the elements such as dust and water, perfect for outdoor use.



### Two-way Talk & Quick Response

Provides real-time communication from your mobile device to individuals at the camera.



### Local Storage w/o Monthly Fee

Supports NVR and Micro SD card (up to 256GB) storage.



### Dual-Band Wi-Fi Connection

Dual-Band 2.4GHz & 5GHz Connectivity greatly enhances the video stream experience without any streaming lag.



### 164° Ultra-wide View

See the full picture with the 164° ultra-wide viewing angle and 4:3 aspect ratio.

# 2K QHD Video with 5MP

High quality sensors present crystal clear videos and recordings.

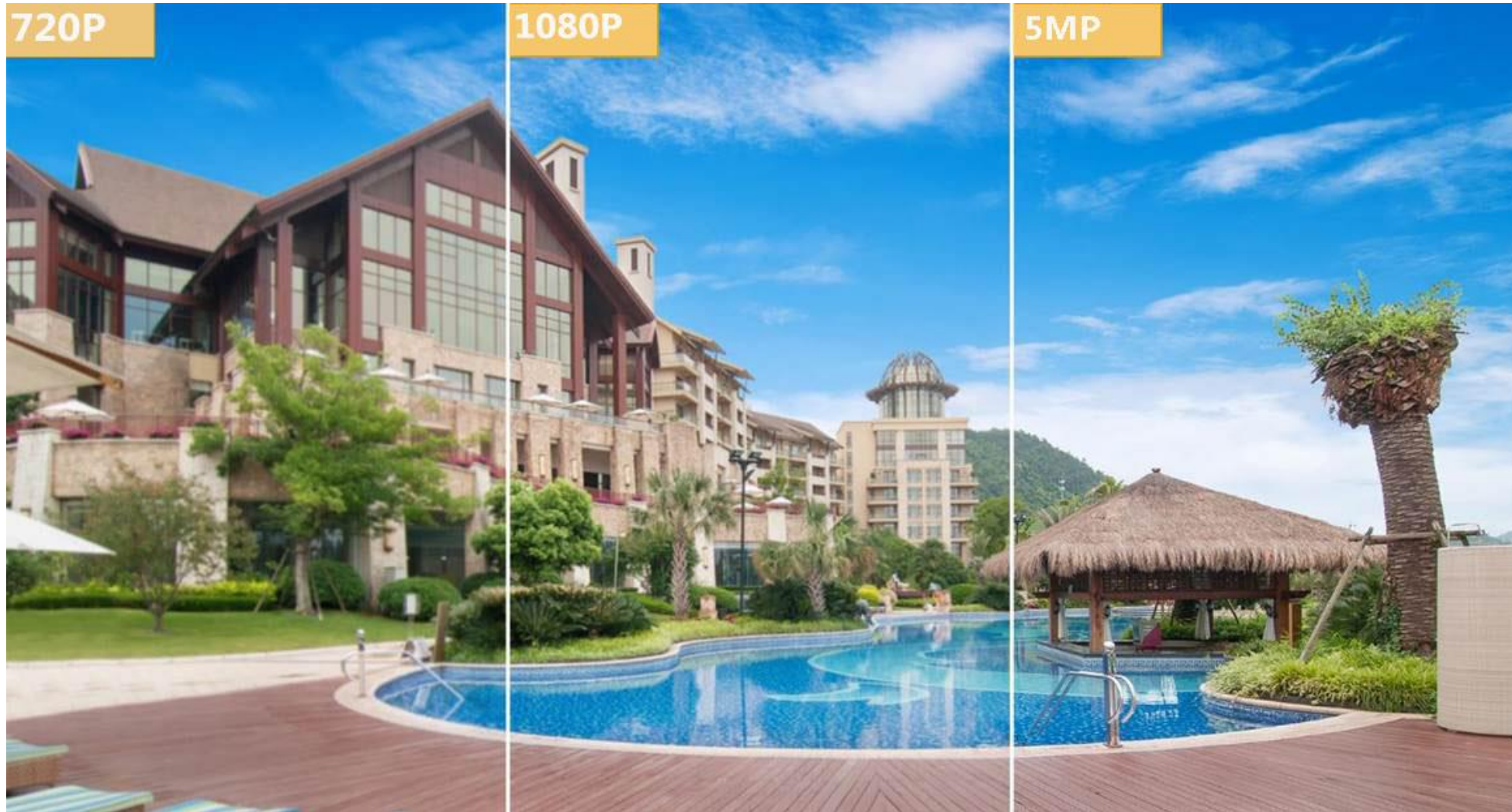



Benefits &  
Key Features

---



164° wide view



Other doorbell camera

DB61 wide view



## Benefits & Key Features

# Fish eye Lens

164° ultra wide angle allows DB61 to capture more details.

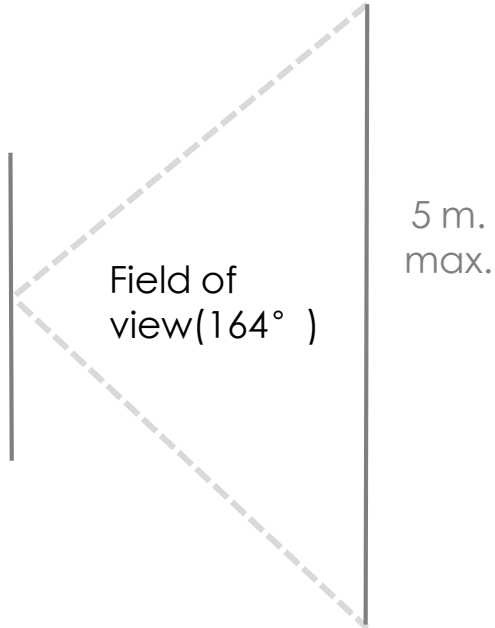
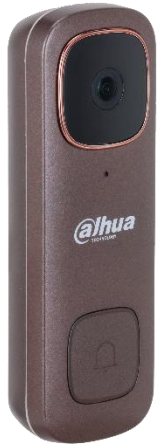

4:3 Aspect Ratio

## Benefits & Key Features



## Full-duplex Two-way Talk

Built-in speaker and microphone allow you to interact with friends and family or dissuade unwelcome guests easily.



## Benefits & Key Features

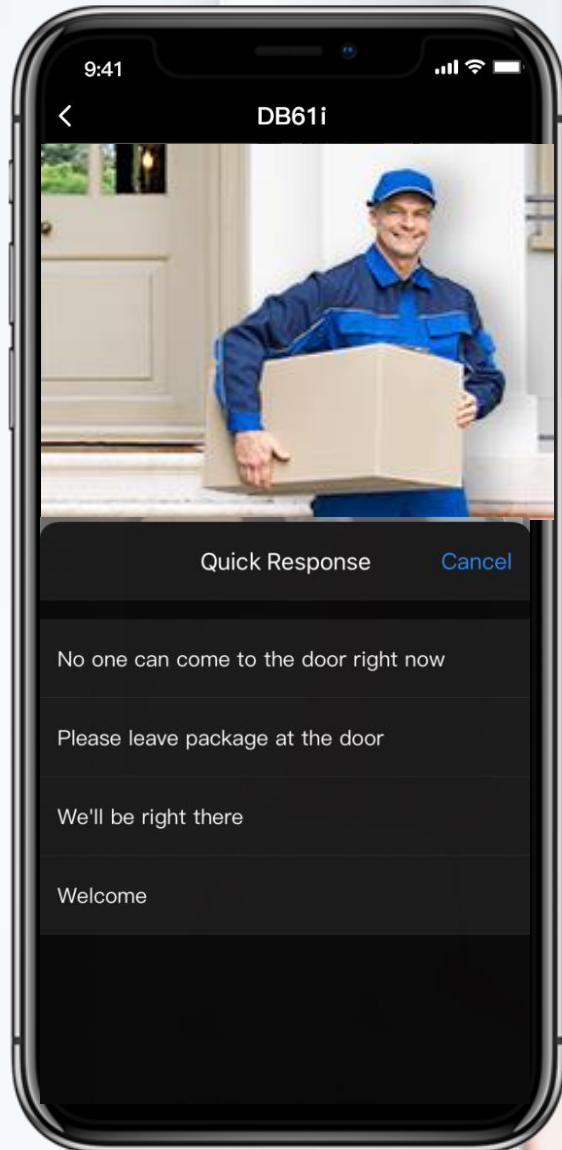

## Pre-record Quick Response

Up to 6 pre-record responses, when you are notified of activity simply select one of your pre-recorded responses to interact and give instructions.



## Benefits & Key Features

---

# Human Detection

Powerful image processing technology quickly finds human targets in images and immediately sends a notification to your smartphone, allowing you to monitor what matters without receiving annoying false alerts.

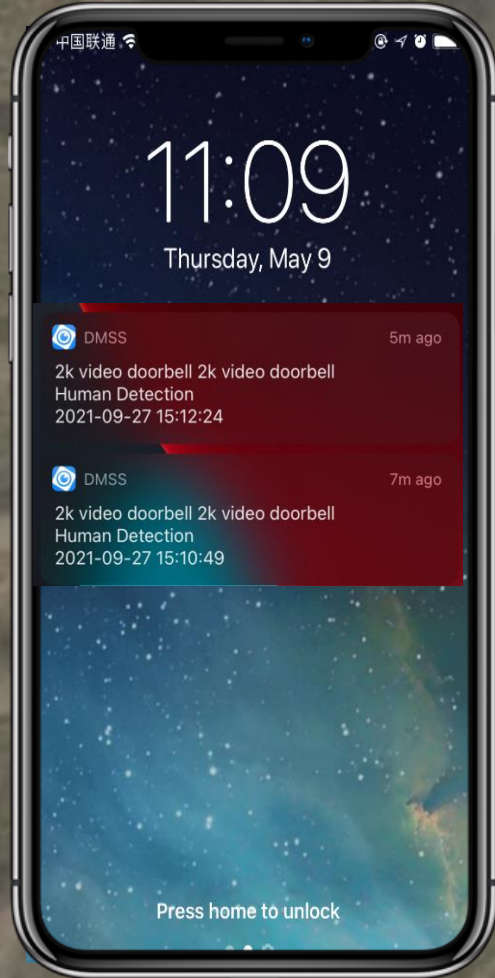



# Smart Detection Zone

Customize the Motion Detection Zone and Human Detection Zone to suit your home so you only receive the alerts you care about.

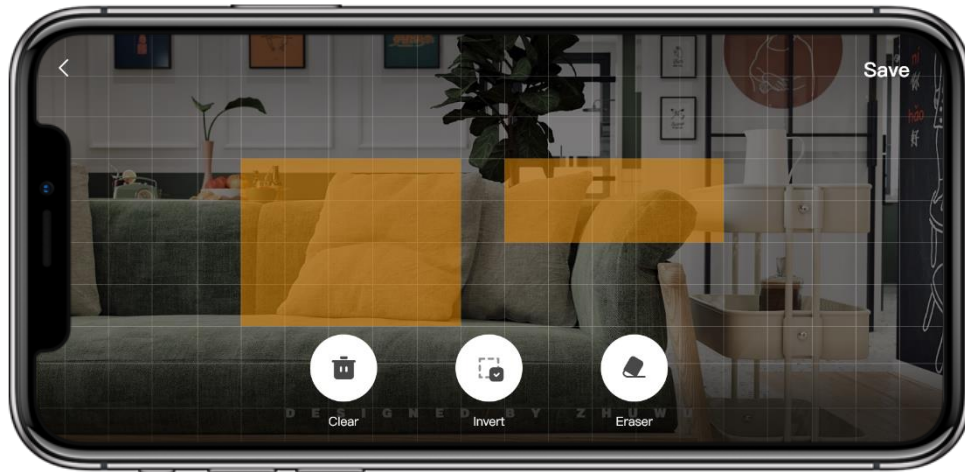

## Motion Detection Zone

Tap and select grid to set motion detection area



## Human Detection Zone

Draw human detection areas  
(up to 3 customized areas support)

# Shed Light on your doorstep

For added security, the LED light can be activated when motion is detected to deter unwanted guests.

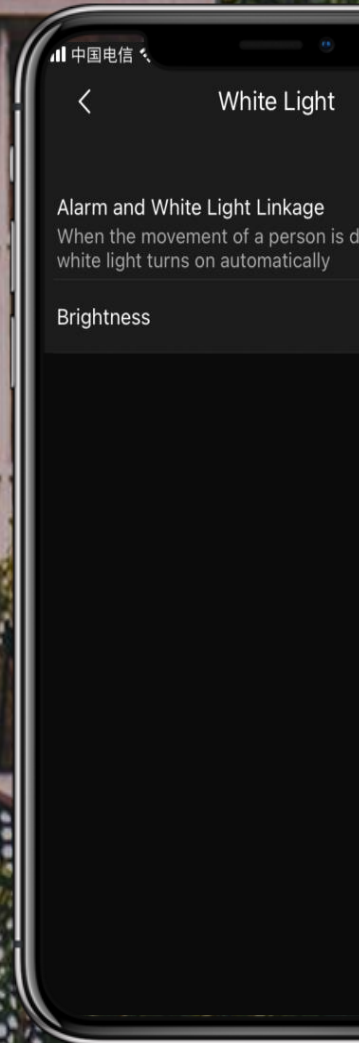





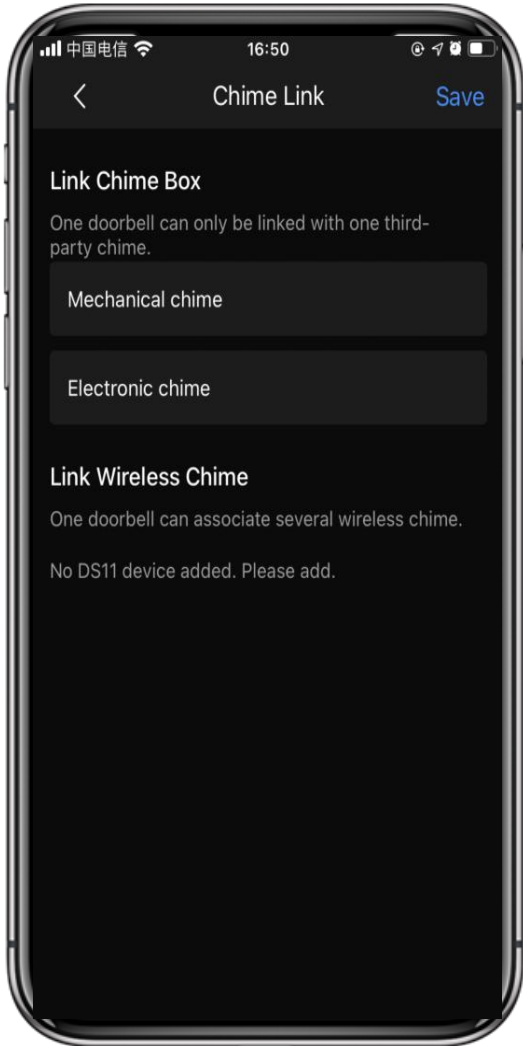

## Benefits & Key Features

# Work with Chime

The 2K Video Doorbell is compatible with traditional mechanical or electronic chime with a voltage between 16 VAC ~ 24 VAC and 12 VDC ~ 24 VDC, and



# comparison

Model	DHI-DB11	DS-HD1	2k Wired Doorbell	Eufy 2K wired doorbell
				
price				
Image Sensor	1/2.7-in. 2 MP CMOS	1/2.8" 3 MP starlight sensor	1/2.9" 5MP CMOS 🍷	unknow
Maximum Resolution	1920 x 1080, 2 MP at 30 fps	2048 x 1536, 3MP at 30 fps	2K(2560*1920)@15fps 4:3 aspect ratio	2560 x 1920 4:3 aspect ratio
Field of View	140°(H), 160°(D)	105° (Horizontal), 180° (Vertical)	D164°*H124°*V92°	unknow
Lens	1.9 mm	2.2 mm @ f2.4	2.27mm @ F2.1	unknow
IR Distance	5.0 m (16.50 ft)	5.0 m (16.50 ft)	5.0 m (16.50 ft)	
Alarm Notification	two PIR sensors Configurable area and distance: Coverage: up to 120° Distance: up to 5.0 m (16.50 ft)	one PIR sensor Alarm Customized alert area	Motion Detection Person Detection Smart Detection Zone Quick response Yes 🍷	Motion Detection Person Detection Smart Detection Zones Quick response
Build-in Light	No	No	Yes	No
Network Connection	Wireless Built-in 2.4 GHz	Wireless Built-in 2.4 GHz and 5 GHz Wi-Fi	Wireless Built-in 2.4 GHz and 5 GHz Wi-Fi	2.4GHz
Storage	up to 64GB SD NVR/XVR	up to 128GB SD NVR	up to 256GB SD NVR/XVR	build-in 4GB eMMC local storage
Ingress Protection	IP55	IP65	IP65	IP65
Power Consumption	Maximum 9W	Maximum 5 W	AC16~AC24, DC12~DC24 3W	16-24VAC
Working temperature	-20° C to +50° C (-4° F to 122° F)	-30° C to 60° C (-22° F to 140° F) 🍷	-20° C ~ +50° C	-20°C ~ 50°C 🍷
Chime Compatibility	Mechanical Chime Digital Chime	Mechanical Chime Digital Chime	Mechanical Chime /Digital Chime dahua wireless chime(DS11) 🍷	Not compatible with mechanical chime or digital chime
What's In the Box	Video Doorbell ChimeKit Installation Tools QSG	Wi-Fi Doorbell Power Kit Installation Tools Angled (2x) and Flat (x1) Mounting Plates Interchangeable Face Plates (White/Black/Gray) 🍷	Wi-Fi Doorbell 15° Horizontal Bracket and 5° Vertical Bracket Flat mounting plate(x1) Chime Kit USB Cable Installation tools Quick Start Guide 32G SD card (pre-insert) 🍷	wifi doorbell screw hole position-card flat mounting bracket 15° angled mounting bracket installation tools and wires detached pin wireless chime doorbell chime power pin



# Scenario

DB6I focus on home appliance and equipped your traditional doorbells with smart videos.

Chime Kit

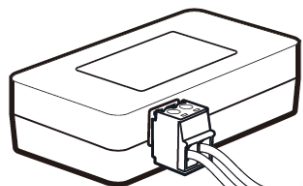

Step 1. Add chime kit to your existing chime.

Step 2. Replace your doorbell with DB6I.

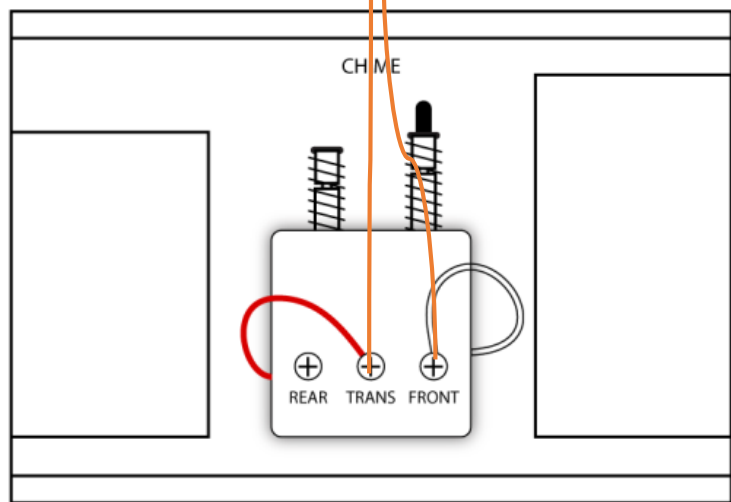

Chime

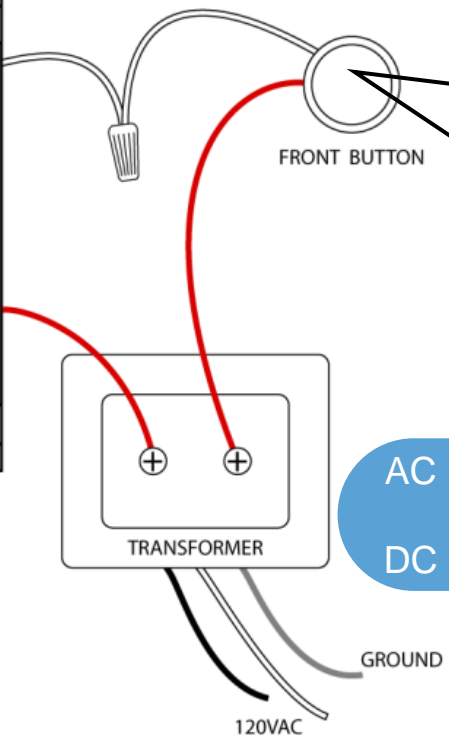

FRONT BUTTON

AC 16~24V  
Or  
DC 12~24V

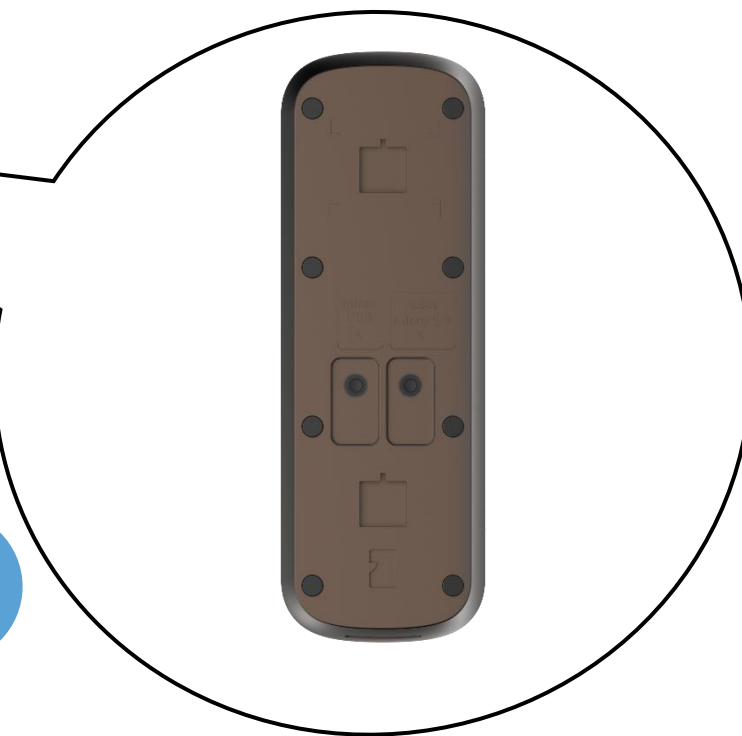

DB6I

\* For upgrading purpose

# Product Info

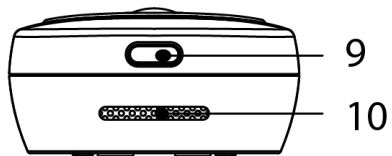
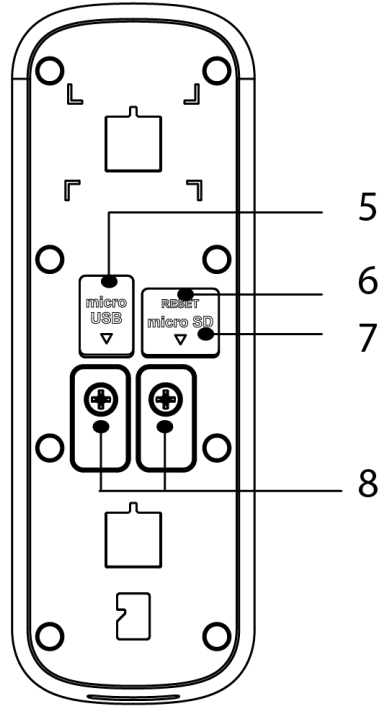
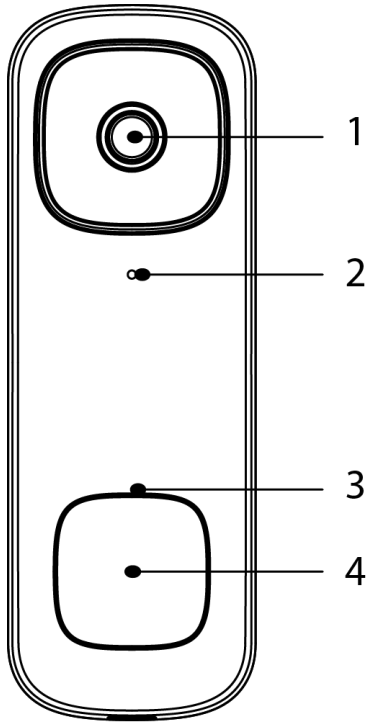

No.	Name	No.	Name
1	Lens	6	Reset
2	Microphone	7	Micro SD Card Slot
3	LED Indicator	8	Power Ports
4	Call Button	9	Night Light
5	Micro USB Port	10	Speaker



# What's in the box



Doorbell  
x1



Mounting Bracket  
x1



Angled Bracket x1  
(15° horizontally)



Angled Bracket x1  
(5° vertically)

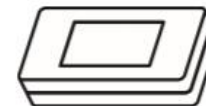

Chime Kit  
x1



Wire Nuts  
x3

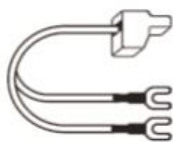

Wire Harness  
x2



Extension Wires  
x2



Wall Anchors  
x2



Mounting Screws  
x2



Pin x1



15/64" Drill Bit x1



Micro SD card  
(pre-inserted)

## Tools Required



Philips-head  
Screwdriver



Drill

## Order Info

---

Product Name	P/N
DH-IPC-DB6I-USA	1.0.01.04.36940
DH-IPC-DB6I-CAN	1.0.01.04.36941

The difference between two models is that the Wi-Fi band is different.

### **CAN version:**

**WIFI 2.4GHz:** IEEE802.11b/g/n 2400-2483.5 MHz, RF POWER≤ 30 dBm

**WIFI 5GHz:** IEEE802.11a/n/ac 5250-5350 MHz & 5470- 5600 MHz & 5650-5725 MHz, RF POWER≤ 24 dBm ; 5725 - 5850 MHz, RF POWER ≤30 dBm

### **USA version:**

**WIFI 2.4GHz:** IEEE802.11b/g/n 2400-2483.5 MHz, RF POWER≤ 30 dBm

**WIFI 5GHz:** IEEE802.11a/n/ac 5150-5350 MHz & 5470 -5725 MHz, RF POWER ≤24 dBm; 5725-5850 MHz, RF POWER ≤ 30 dBm



Any Question?  
Thank you!