

THE GRIMOIRE OF ARMADDEL

TRANSLATED AND EDITED FROM
THE ANCIENT MANUSCRIPT IN THE
LIBRARY OF THE ARSENAL, PARIS

BY S. L. MacGREGOR MATHERS
Comte de Glanstrae

WITH AN INTRODUCTION
AND ADDITIONAL NOTES BY
FRANCIS KING



THE GRIMOIRE OF ARMADEL



Operation of URIEL SERAPHIM.

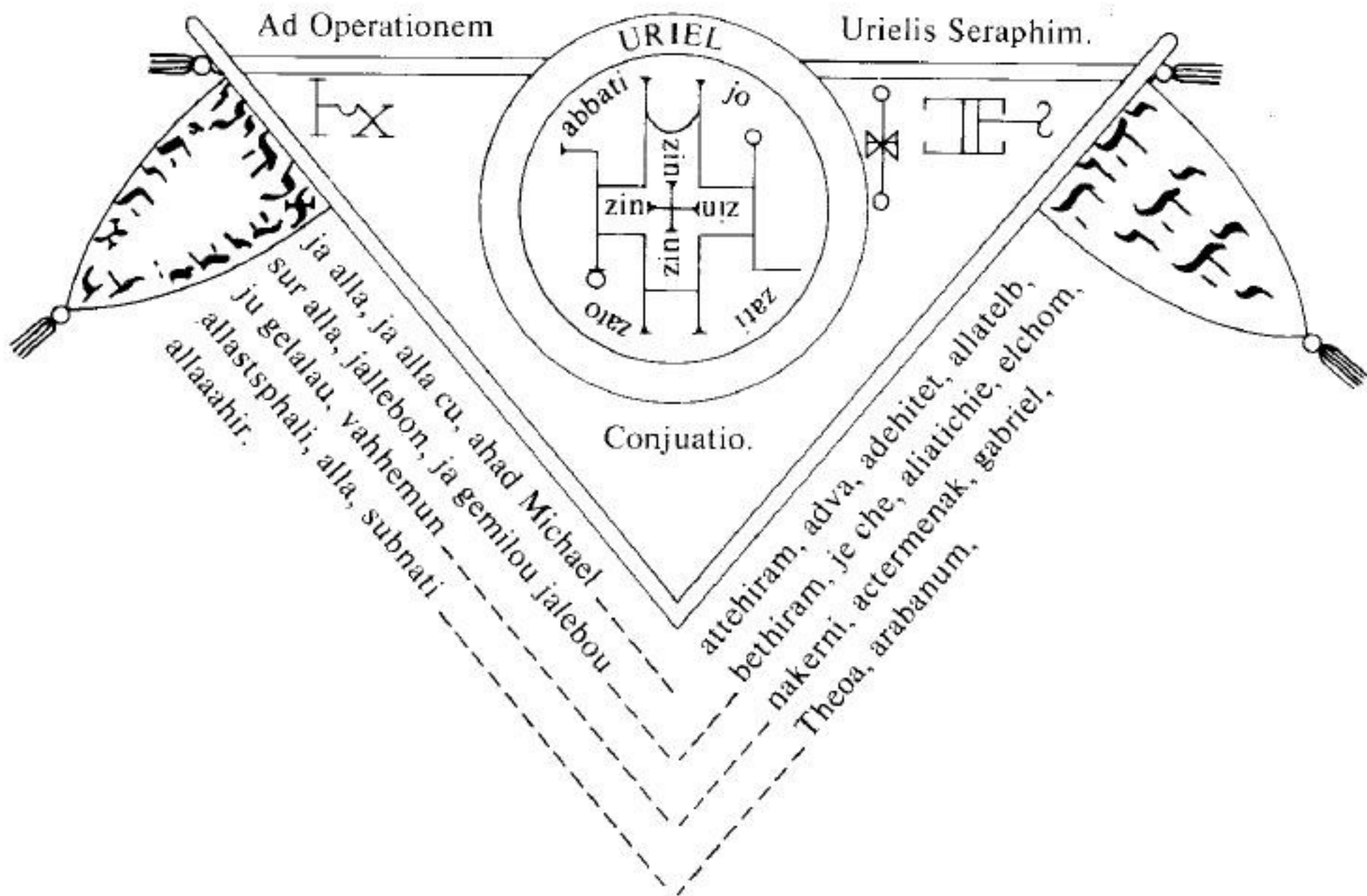
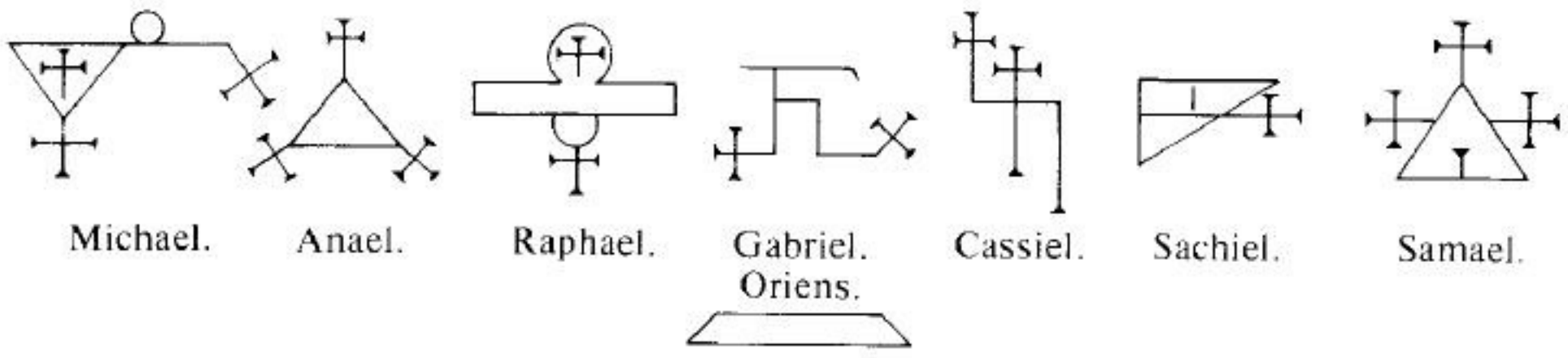

THE GRIMOIRE OF ARMADEL



TRANSLATED AND EDITED
FROM THE ANCIENT MANUSCRIPT IN THE
LIBRARY OF THE ARSENAL, PARIS
BY
S. L. MACGREGOR MATHERS
Comte de Glenstrae

With an introduction and additional notes by
FRANCIS KING



ROUTLEDGE & KEGAN PAUL
LONDON AND HENLEY

*First published in 1980
by Routledge & Kegan Paul Ltd
39 Store Street, London WC1E 7DD and
Broadway House, Newtown Road,
Henley-on-Thames, Oxon RG9 1EN
Set in 11/14pt Palatino by Oxprint Ltd
and printed in Great Britain by
Lowe & Brydone Ltd*

*© Routledge & Kegan Paul Ltd 1980
No part of this book may be reproduced in
any form without permission from the
publisher, except for the quotation of brief
passages in criticism*

*British Library Cataloguing in Publication Data
The grimoire of Armadel.*

1. Magic

I. Mathers, S Liddell MacGregor

133.4'3 BF1602 79-40851

ISBN 0 7100 0083 9

CONTENTS



INTRODUCTION p1

1. MACGREGOR MATHERS AND HIS TRANSLATIONS p1
2. THE GRIMOIRE OF ARMADEL AND ITS USE IN MAGIC p6

THE MAGIC OF ARMADEL p15

THE THEOSOPHY OF
OUR FOREFATHERS OF THEIR SACRED AND MYSTIC
THEOLOGY BY ARMADEL p21

AS REGARDETH THE PLANETS. THE SANHEDRIN p23

THE CIRCUMCISION OF JESUS AT NAZARETH p24

BY THE FLOWING OF JORDAN p25

THE SON OF ZACHARIAS IN THE DESERT p26

IN THE FIELDS OF BABYLON p27

THE SPIRIT OF ELISHA p28

OF THE LIFE OF ELIJAH p29

THE WISDOM OF SOLOMON p30

THE EXPLORER AND LEADER JOSHUA p31

THE VISION OF 'MAN' p32

THE ROD OF MOSES p33

MOSES IN THE INTERIOR OF THE DESERT p34

THE CAVE OF EPHRON p35

THE GOING-FORTH OF ABRAHAM FROM UR OF THE CHALDEES

AND FROM HARAN p36

THE WISDOM OF OUR FOREFATHER ADAM p37

THE BEHOLDING OF THE SERPENT p38

THE VISION OF FORMATION— ADAM p39

THE VISION OF EDEN, OR OF THE TERRESTRIAL PARADISE p40
CONCERNING PHITONE OR THE ABUSES OF NECROMANCY p41
CONCERNING THE COMMUNICATION OF THE GENII p42
CONCERNING THE TRANSFORMATION OF THE GENII p43
CONCERNING THE NATURE OF THE GENII p44

THE SACRO-MYSTIC THEOLOGY OF OUR FATHERS p47

CONCERNING THE SCIENCE OF THE REGENERATION OF ADAM
AND HIS CHILDREN BY PELECH p47
CONCERNING THE DEVILS AND HOW THEY MAY BE BOUND AND
COMPELLED TO VISIBLE APPEARANCE p48
CONCERNING THE DEVILS AND HOW THEY CAN BECOME VISIBLE p50
CONCERNING THE DEVILS AND HOW THEY MAY BE BOUND AND BECOME VISIBLE p51
CONCERNING THE WAYS OF KNOWING THE DEVILS AND OF
BANISHING THEM p52
CONCERNING THE DEVILS AND THEIR LIFE p53
CONCERNING THE WAYS OF KNOWING THE GOOD ANGELS,
AND OF CONSULTING THEM p54
CONCERNING THE LIFE OF MAN p55
CONCERNING THE CREATION OF THE SOULS OF MEN p56
CONCERNING THE EVANGELIC REBELLION AND EXPULSION p57
CONCERNING THE LIFE OF THE ANGELS BEFORE THE FALL p58
CONCERNING THE CREATION OF ALL THE ANGELS p59
CONCERNING GOD, THE PRESERVER, THE DESTROYER, AND THE CREATOR p60
CONCERNING GOD IN HIS TRINE PERSONALITY p61
CONCERNING GOD THE UNIVERSALLY ONE p62
CONCERNING THE PATHS OF WISDOM p64

THE RATIONAL TABLE p67

THE FIRST CHARACTERS p67
THE VISION OF ANOINTING p69
THE VISION OF DUST p70
THE PREPARATION OF THE SOUL (I) p74
THE PREPARATION OF THE SOUL (II) p75
THE CHARACTERS OF MICHAEL p77
ORIGINAL LATIN TITLE PAGE p79

FIGURES



OPERATION OF THE URIEL SERAPHIM FRONTISPIECE

- A THE MAGIC SQUARE OF MARS p8
- B THE SQUARES OF BRTzBAL p9
- C THE TRUE SIGIL OF BRTzBAL p9
- D THE FORMAL SIGIL OF BRTzBAL p9
- 1 THE SIGIL OF ZADKIEL p23
- 2 THE SIGIL OF THAVAEI p24
- 3 THE SIGIL OF CAPHAEL p25
- 4 THE SIGIL OF SAMAEL p26
- 5 THE SIGIL OF URIEL p27
- 6 THE SIGIL OF MICHAEL p28
- 7 THE SIGIL OF GABRIEL p29
- 8 THE SIGIL OF RAPHAEL p30
- 9 THE SIGILS OF HETAEL p31
- 10 THE SIGILS OF VAU-AEL p32
- 11 THE SIGILS OF ZAINAEL p33
- 12 THE SIGILS OF HETHATIA p34
- 13 THE SIGILS OF TETAHATIA p35
- 14 THE SIGILS OF ALEPTA p36
- 15 THE SIGILS OF BETEL p37
- 16 THE SIGILS OF GIMELA p38
- 17 THE SIGILS OF DALÉTÉ p39
- 18 THE SIGILS OF PHALET p40
- 19 THE SIGILS OF SAMAEL p41
- 20 THE SIGILS OF CAMAEL p42
- 21 THE SIGILS OF HANIEL p43
- 22 THE SIGILS OF ANAEL p44
- 23 THE SIGILS OF OPHIEL p47
- 24, 25 THE SIGILS OF ASMODÉ AND LEVIATAN p49

- 26 THE SIGILS OF HEMOSTOPILÉ p50
- 27 THE SIGILS OF BRUFOR p51
- 28 THE SIGILS OF LAUNÉ p52
- 29 THE SIGILS OF BETOR p53
- 30, 31 THE SIGILS OF ZADKIEL AND SACHIEL p54
- 32, 33 THE SIGILS OF PHUL AND GABRIEL p55
- 34 THE SIGILS OF ARATRON p56
- 35, 36, 37 THE SIGILS OF LUCIFER, BELZEBUT AND ASTAROT p57
- 38 THE SIGILS OF ZAPHKIEL p58
- 39 THE SIGILS OF OCH p59
- 40 THE SIGILS OF GABRIEL p60
- 41 THE SIGILS OF MICHAEL p61
- 42 THE SIGILS OF CASSIEL p62
- 43 THE SIGILS OF THE SPIRITS OF FORCE AND COUNSEL p64
- 44 THE SIGILS OF THE SPIRITS OF JOY p64
- 45 THE SIGILS OF THE ANGELS OF LOVE AND CHARITY p65
- 46 THE SIGIL OF GOOD FORTUNE p67

INTRODUCTION



1. MACGREGOR MATHERS AND HIS TRANSLATIONS

The *Grimoire of Armadel* is one of those do-it-yourself textbooks of ceremonial magic of which the most famous are the *Key of Solomon* and the (forged) fourth book of Cornelius Agrippa's *Occult Philosophy*. Hitherto the *Armadel* seems to have circulated only in manuscript form and one of the principal points of interest about this, its first printed edition, is that the translation and notes are by S. L. MacGregor Mathers, Comte de Glenstrae (1854–1918), who was himself not only a practising magician, the man responsible for transforming a small, secret sodality known as the Hermetic Order of the Golden Dawn into the magical fraternity that was undoubtedly the *fons et origo* of the current craze for ritual magic, but one of the most amusing English eccentrics of the last 150 years. *English* eccentrics? Yes, for in spite of the Celtic splendours of the names MacGregor and Glenstrae their bearer was by birth a Londoner and his actual connections with Scotland were almost certainly quite imaginary.

I have been unable to trace any records of Mather's birth or baptism but Wynn Westcott, his magical colleague and eventually his rival, has recorded that he was born in Hackney, the son of a commercial clerk named William Mathers. A tenuous Scottish connection is suggested by a surviving tradition that William Mathers's wife was a Glaswegian by birth but, if so, she was probably of Irish rather than Scottish ancestry, for Westcott believed that her maiden name had been Collins.¹

¹ The full text of Westcott's memorandum can be found on pp. 37–8 of Ellic Howe's painstakingly researched and often amusing *The Magicians of the Golden Dawn* (Routledge & Kegan Paul, 1972). This book has been responsible for a good deal of ill-tempered wing fluttering in certain present-day magical dovescotes but is, nevertheless, essential reading for Yeatsian scholars, nineteenth-century social historians and, above all, magicians.

Mathers went to Bedford School, leaving it a few months before his seventeenth birthday. Nothing is known of how he occupied himself in the years immediately following this event but, like Aleister Crowley (who, years later, was to become his pupil in magic) he was hardly cut out for the tedium of ordinary life and it is likely that any periods of paid employment were of but brief duration. By 1877 he was living in Bournemouth with, and presumably upon, his widowed mother. Mathers must have enjoyed this period of his life; he became an amateur soldier, probably in the 1st Hampshire Infantry Volunteers, was initiated into freemasonry and, under the tuition of a bibliophile named Frederick Holland, began the studies in mysticism and magic that for the rest of his life were to occupy much of his time.

It may have been before the Bournemouth period that Mathers first read Bulwer Lytton's *Zanoni*, a 'three-decker' occult novel which exerted a considerable influence upon him—as, indeed, it did upon a whole generation of nineteenth-century occultists. The novel tells the story of Glyndon, an eighteenth-century Englishman with mystical inclinations who studies 'Rosicrucian' philosophy under the mysterious Zanoni, a character Lytton clearly based on that intriguing charlatan, the Comte de St-Germain. So great was Zanoni's fascination for Mathers, so obvious his attempts to model his behaviour upon that of Lytton's hero that Moina Bergson (who eventually became Mathers's wife) nicknamed him 'Zan' and familiarly addressed him by that name until the end of his life. Mathers looked upon *Zanoni* as something beyond a mere novel; he believed that Lytton was an authentic Rosicrucian who had chosen to convey important occult teachings under the guise of fiction² and that almost every incident in the story had some magical significance. Thus, for example, in a didactic Golden Dawn treatise entitled *On the Tattwas of the Eastern School*—it deals with various types of 'etheric energy' and how they can be controlled by such means as breathing exercises³—Mathers inserted an odd note explaining that:

Zanoni secured success in gaming for Cetosa and overcame the effects of the poisoned wine of the Prince di D— as follows. In the first place, he changed his breath to the right nostril, and threw an envelope of the Akasa Tattwa over his antagonist, who consequently became all empty, the money in gaming flowing towards the Surya Swara. In the latter he brought the Apas Tattwa into course, directed it with the full force of his

² Mathers's opinion may not be quite so outlandish as it might seem. Lytton dabbled in occultism, was on friendly terms with the French magician, Eliphas Lévi, and was Grand Patron of the quasi-monastic Rosicrucian Society of England.

³ *On the Tattwas of the Eastern School* was little more than a précis of Rama Prasad's *Nature's Finer Forces*, an early Theosophical work which was itself derived from Tantric sources.

trained will towards the poisoned wine, and consequently the burning heat of the poison was counteracted for a very long time, and before it could recover strength enough to act on the system, it was there no longer.

By Akasa was meant 'elemental spirit'—something very like the quintessence of the Alexandrian Hermetic philosophers; by Apas was meant a lunar, fluid principle, 'elemental water'; and by Surya Swara was meant a current of elemental force supposedly attracted to a 'yogic nerve' traditionally associated with the right nostril and bronchus.

Mathers found his cultivated Zanonian mask of lordly indifference of comfort to him in 1885 when he was suddenly reduced to poverty by the death of his mother—presumably her income had been derived from an annuity which had ceased with her death. She may have left a little money to her son but, if so, he must have spent all of it on the printing bill for the publication of his first original work, *The Fall of Granada: A Poem in Six Duans* (1885), which fell still-born from the press. He moved to London where, fortunately for himself, he was already on friendly terms with William Wynn Westcott—both men were members of the Rosicrucian Society of England—who extended to him hospitality and, probably, a certain amount of financial assistance. Westcott, described by his acquaintance, A. E. Waite, as being 'like a dull owl hooting dolefully among cypresses over tombs of false adepts', was a qualified physician with some pretensions to occult scholarship, a love of dressing up in exotic masonic regalia and a considerable admiration for Madame Blavatsky, the Russian adventuress who had founded the Theosophical Society in 1875.

Mathers knew H. P. Blavatsky well; he had been introduced to her by Anna Kingsford, a Victorian seeress who cries out for a biographer, and it is clear that Blavatsky, whose learning was only skin-deep, was impressed by the erudition of the young magician whose remarks on the subject of the cabbalah she quoted with approval in her book, *The Secret Doctrine*. At this time Mathers was deeply involved in the study of cabbalism and in 1887 he published *The Kabbalah Unveiled*, a translation of three of the major books of the *Sepher ha Zohar*. It is unlikely that Mather's scholarship would have been equal to making a direct translation from the Aramaic Chaldee of the original text and in fact he used the seventeenth-century Latin version of Knorr von Rosenroth.⁴

The publisher of *The Kabbalah Unveiled* was George Redway, a somewhat dubious dabbler in occultism and mild pornography who succeeded in buying the copyright outright for only £35. This was a real bargain; since its first publication *The Kabbalah Unveiled* has remained almost continuously in print

⁴ Nevertheless when alleged mistakes in the translation were pointed out by a Theosophical reviewer Mathers defended himself with the claim that there had been errors in the Latin version which he had discovered and corrected on the basis of his examination of the original Chaldee text.

and it was in its eleventh impression in 1972. For an even smaller sum Redway also bought the copyright of *The Key of Solomon*, the first of three grimoires translated by Mathers.

The Key of Solomon splendidly illustrates Mathers's odd blend of curious learning and intense credulity. On the one hand his reconstruction of the mangled sigils and Hebrew lettering of the various pentacles (talismans) showed a detailed knowledge of the magical literature of the Renaissance, a considerable acquaintance with the Massoretic version of the Old Testament and a capacity for hard work. On the other hand he naïvely assigned the authorship of the grimoire to King Solomon, airily remarking that he saw 'no reason to doubt the tradition which assigns the authorship of the *Key* to King Solomon'.

Thinking as he did that the *Key* was 'a work of the highest authority', the 'fountain-head and storehouse of Qabalistical Magic', Mathers was puzzled by certain elements in it, notably the advocacy of blood sacrifice and the presence of certain 'experiments' that clearly smacked of black magic. He carried out as much bowdlerization as his conscience allowed, and explained what remained as allegory. The exact nature of Mathers's allegorical interpretation is unknown, for he regarded it as valuable magical knowledge, to be conveyed only to trusted pupils under oath of secrecy, but we can get a fair idea of it from similar interpretations put forward by contemporary magicians. One grimoire, for example, gives a formula for 'discovering a woman's deepest secret' which involves taking out the tongue of a living toad and placing it over the heart of the woman when she is asleep. A modern occult commentator has claimed that 'the toad is the third of Beelzebub's 72 spirits, Bilifares, who appears as a great black-headed toad—he is the opposite of the good spirit Vassago. The spell means that Bilifares is to be compelled to make her talk in her sleep.' The same occultist has given a complex demonic explanation of a messy spell (pick a lily in June under the waning moon, moisten it with laurel juice and bury it in dung; worms will breed, dry them and scatter on the victim's pillow) designed to produce a restless night. 'The lily in June under a waning moon', we are informed, 'means Lilith Queen Night under the influence of the demon Shimri; the laurel is the Raven of Dispersion, Q'areb Zarag'.

In 1892 Mathers and his wife moved to Paris where they lived on the involuntary donations of their friends, occupying their time with eccentric politics—Mathers and his friend, J. W. Brodie-Innes, seem to have been active on the lunatic fringe of Spanish Carlism⁵—the invocation of spirits and much esoteric research. Mathers soon discovered the vast collections of magical

⁵ My supposition is based on the facts that (a) Mathers and Brodie-Innes are known to have had a close political relationship, (b) Brodie-Innes's novel, *Old as the World*, shows an inside knowledge of late

material in the Parisian libraries and in 1896 began his translation of *The Sacred Magic of Abramelin the Mage*, a magical textbook which is quite unlike anything else in European occult literature. Abramelin the Mage, whoever he may have been, was essentially a radical; he abandoned the rituals, consecrated swords, protective circles, etc. of classical western magic in favour of a yoga-like technique of isolation and withdrawal from the world. This lasted six months and supposedly concluded with the adept gaining 'the Knowledge and Conversation of his Holy Guardian Angel', following which he could proceed with safety to the manufacture of the forty-nine talismans designed to produce such wonders as 'the finding of a great treasure' and the control of phantom armies.

Originally *The Sacred Magic* was to have been published by Redway but Mathers, infuriated by some suggestions made by that publisher's reader—A. E. Waite, who saw Mathers as 'a comic Blackstone of occult lore'—and by the miserliness of the sum offered for the copyright, got one of his followers, a stockbroker named F. L. Gardner, to publish it on a profit-sharing basis. The profits to be shared were in fact non-existent, for the book sold very badly; Mathers did quite well out of it, however, for he had managed to extract a £55 loan (to be paid back out of profits) from his partner.

I would speculate that Mathers's version of the *Armadel* was prepared at some time between July 1897, the month in which Mathers delivered his completed Abramelin manuscript to Gardner, and February 1899; by the latter date it had become clear that the *Sacred Magic* was a financial disaster and it is most unlikely that Mathers would have wasted his time on producing yet another grimoire subsequently.

By this time Mathers's behaviour had alienated many of his followers and his contacts with them were few. By 1901 such contacts had become non-existent, for the great majority of Golden Dawn members had rebelled against their Chief and established a schismatic magical fraternity. The rebels seem to have remained in complete ignorance of the existence of the *Armadel* but copies did circulate amongst the members of the Rosicrucian Order of the Alpha et Omega (the group which remained loyal to Mathers) who used it in ways described in the second part of this introduction.

The later histories of Mathers and the magic fraternities inspired by him do not concern us here, but they are not without interest and those readers who desire some knowledge of them are referred to Mr Howe's *Magicians of the Golden Dawn*, which deals in great detail with the period 1887–1923, and to my

nineteenth-century Carlism and its association with Iberian anarchism, and (c) Aleister Crowley, at the time on terms of close friendship with Mathers, was very probably involved in the Jacobite-Carlist conspiracy of 1899.

own *Ritual Magic in England* which gives, to quote Mr Howe, 'an account of the post-1923 Temples which continued to keep the Golden Dawn tradition more or less alive'.

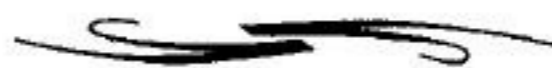

2. THE GRIMOIRE OF ARMADDEL AND ITS USE IN MAGIC

While the etymological origin of Armadel is uncertain, the word seems not to have any occult significance but to be a personal name. The British Museum's manuscript, Lansdowne 1202, is entitled *The True Keys of King Solomon by Armadel*, but this is no more than a version of the *Key of Solomon* with a number of sigils (seals) of evil spirits added at the end.

These sigils bear a certain resemblance to some of those reproduced in the text of this book, but according to Mathers they were derived from a medieval black-magical text entitled the *Grimorium Verum* and falsely attributed to King Solomon. I have not had an opportunity of examining a copy of this last-mentioned work, but if Mathers's statement was correct the *Armadel* may be ultimately derived from the *Grimorium Verum*; in this case, however, it must have suffered a major reworking in the period 1650–1700 for although the manuscript from which Mathers worked (Bibliothèque de l' Arsenal, Sc. et A. No. 88) is written in French it clearly belongs to a family of seventeenth-century German magical texts which were manufactured to exploit commercially the reputation of the semi-legendary Dr Faust.

Nothing is known of the original Faust. Probably he was a magician of the late fifteenth century, for the earliest of references to an occultist of that name seems to imply that he was the imitator of some well-known original. The allusion in question, made by Trithemius in a letter dated August 1507, is given in the form of a warning against a man 'who is a fool and no philosopher' and who has 'adopted the following title: Magister Georgius Sabellicus, *Faustus Junior*, Fountain of Necromancers, astrologer, magus secundus, chiromancer, aeromancer, pyromancer, second in hydromancy'.

The fame of both first and second Faustus spread throughout Germany and, with time, they became confused with one another—or so it seems from the nature of the incompatible stories, some representing their hero as almost a

semi-divine being, others showing him as a vulgar confidence trickster, that made up the Faust legend as it was recorded in the first *Faustbook* (1587). This seems to have had an almost universal appeal; translated into English it inspired Marlowe, stumblingly read aloud by the light of peasant firesides its stories soon became part of popular German folklore, and studied by the more materialistically motivated of would-be sorcerers it created in them a desire to have access to the Faustian formulae that would produce, among other things, an ever-full purse and the love of Helen of Troy.

One of the curiosities of the history of occult literature is the fact that a potential market for *any* magical text, even an imaginary one, will ultimately be supplied with the required article. Thus in the sixteenth century Edward Kelley, that strange companion of John Dee, claimed to have discovered a hitherto unknown alchemical text, the *Book of St. Dunstan*, and to have transmuted base metal into gold by the use of its formulae. All over Europe the alchemists became excited, feeling that perhaps Kelley's book (which no one save the gullible Dee had ever seen) would teach them the long-sought secret of the manufacture of the philosophers' stone; within fifty years at least three different (forged) versions of the book were on the market. Such credulity is still widespread; H. P. Lovecraft, the American pulp writer, used the *Necronomicon*, an imaginary magical text, as a piece of literary machinery in many of his stories. Inevitably, certain present-day magicians have chosen to believe in the real existence of this work and their desire to own a copy of it was first met by an ingenious forger whose manuscript production sold at up to £50 a copy and then by two printed versions—amusing hoaxes which will probably become collectors' items.

In exactly the same way the desire of seventeenth-century magicians to emulate Faust led to the production of a whole family of occult MSS, purporting to contain authentic Faustian formulae. It is to this family that the *Armadel* belongs and, like its siblings, its most notable characteristics are its descriptions of the natures and offices of the various evil spirits and its reproduction of the sigils—seals supposedly giving power over demons—appropriate to those same spirits. How exactly the sigils of the *Armadel* were created has been forgotten, but it must not be assumed that they were the products of the random fantasies of some eccentric occultist and it is probable that they were designed by the use of some variation of the techniques employed in the construction of the seals of the 'planetary intelligences and spirits' to be found in the writings of Cornelius Agrippa.

The *rationale* of these last-mentioned seals has puzzled several distinguished historians of Renaissance thought. It must be admitted, however, that this puzzlement has arisen from the curious tendency of

academics to disregard totally occult sources of their own day. Thus even K. A. Nowotny, who came nearer to solving the problem,⁶ failed to realize that the secret of the construction of these seals lies in the use of *Aiq Bekr*, the 'cabbalah of nine chambers', described in detail in such easily accessible sources as Mathers's introduction to his *Kabbalah Unveiled* and Dr Israel Regardie's *Golden Dawn*.

The 'cabbalah of nine chambers' is neither more nor less than a Hebrew form of 'Theosophical Addition', a numerological technique which still has many devotees,⁷ and it simply involves 'knocking the noughts off the end' of the numerical values of the Hebrew alphabet. The letter Shin, for example, which has a numerical value of 300, is taken as 3. The names of the planetary spirits are first written out in Hebrew, then transposed into their simplest numerical form; finally, lines are drawn on the 'magic square'⁸ of the particular planet connecting up the appropriate numbers, thus giving the required seal.

Take, for example, Bartzabal, the spirit of Mars whom Aleister Crowley claimed to have invoked in 1910 (suitably enough, Bartzabal prophesied the coming World War). In Hebrew his name is spelt BRTzBAL,⁹ with a numerical value of 2, 200, 90, 2, 1 and 30 which, by *Aiq Bekr*, becomes 2, 2, 9, 2, 1 and 3. The magic square of Mars is as follows:

11	24	7	20	3
4	12	25	8	16
17	5	13	21	9
10	18	1	14	22
23	6	19	2	15

FIGURE A

⁶ In his article on pp. 46–57 of the *Journal of the Warburg Institute*, XII, 1949.

⁷ An excellent description of the use of 'Theosophical Addition' in popular, contemporary numerology may be found in the appropriate section of Richard Cavendish's *The Black Arts* (Routledge & Kegan Paul, 1967).

⁸ It is uncertain when the planets were first associated with magic squares; certainly they were by the late classical period.

⁹ I have adopted the mode of transliteration customarily employed by western occultists.

and the significant squares for BRTzBAL are indicated as:

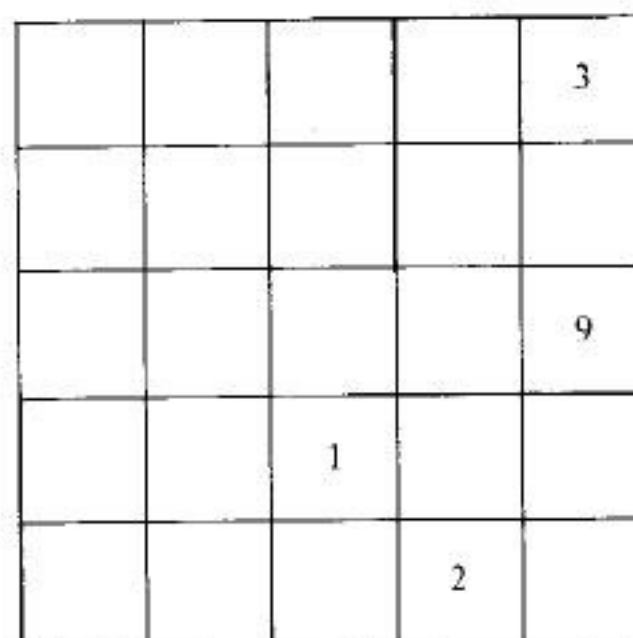

FIGURE B

A double loop (ω) is drawn on the figure 2, representing the first two letters, a line is drawn to the figure 9, back to 2, on to 1 and finally to 3 where by convention, a small circle is drawn indicating the conclusion of the sigil. Thus:

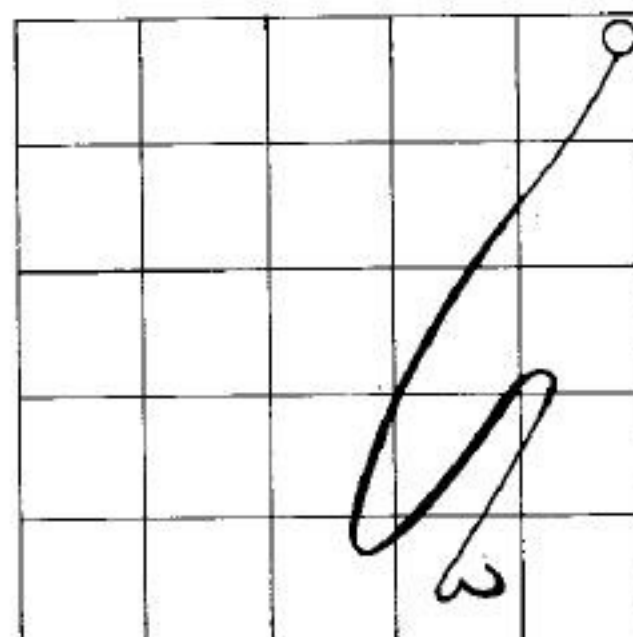

FIGURE C

Or, in the slightly formalized form usually adopted by occultists:



FIGURE D

The *Armadel's* sigils of spirits are likely to have been produced by this method.¹⁰ In addition, however, some of them probably incorporate conventionalized pictorial representations of the supposed attributes of the symbolized entities. Thus the sigil of Anael, who is described as a 'spirit of Power', seems to me to be meant to represent an erect penis, while that of Gimela, a spirit who 'maketh you to know and behold the form of the serpent which did tempt Eve in the Terrestrial Paradise', is, I think, nothing more than a diagrammatic representation of male ejaculation.

Such occultists as Mathers would have been deeply shocked by sexual interpretations of this kind, but there is little doubt that an undercurrent of allegorized sexual magic, similar to that associated with Aleister Crowley, is present in parts of the *Armadel*—for example, in the chapters entitled *The Vision of Anointing* and *The Vision of Dust*.

One further point is worth noticing—the surprising resemblance between some of the sigils of the *Armadel* and the *vevers* (large symbolic diagrams usually traced with cornmeal or coloured powders) employed in the ceremonies of Haitian voodoo. It may be that these resemblances are entirely coincidental, but it is more likely that eighteenth-century grimoires reached Haiti in the colonial period and subsequently influenced the more literate of the voodoo priesthood. It is of some interest that the *Sixth, Seventh and Eighth Books of Moses*, a Faustian textbook of the same family as the *Armadel*, has reached West Africa in English translation and currently enjoys a high reputation among Ghanaian occultists.

But how were the sigils of the *Armadel* employed? The answer depends on whether the magician who used them was a man of the seventeenth century or the nineteenth. Those of the earlier period had a strangely materialistic approach to the nature of the spirit world. Mephistopheles, for example, was looked upon as a person in exactly the same way as the magician was himself a person, and subject to the same laws of time and space—hence the solemn injunctions to evoked spirits contained in many medieval magical texts urging the demon to send a substitute in his place if he was already employed in being evoked by someone else! Sigils were regarded as pictorial representations of the true names of the spirits and, once a spirit had been evoked, the possession of its sigil gave the magician power over it (compare the widespread primitive custom of the individual having a secret name, never used in ordinary life, and the belief that knowledge of the secret name would give the knower power over its owner).

¹⁰ The seals of the planets themselves, however, present a much more difficult problem. In his introduction to the American edition of Francis Barrett's *The Magus* Mr Timothy d'Arch Smith gives a characteristically elegant 'solution' which, alas, does not appear to work for any of the seals except that of Saturn.

Mathers and his fellow magicians of the nineteenth century held much more subtle beliefs about the world of spirits. They too believed in the existence of discarnate entities, not so much as an objective reality but rather as a reasonable working hypothesis. J. W. Brodie-Innes, who combined being a lawyer with holding office in an eccentric literary society called Ye Sette of Odde Volumes and the practice of magic, wrote that: 'Whether the Gods . . . really exist is comparatively unimportant; the point is that the universe behaves as though they do. . . .'

Sigils were used in two ways by these latter-day Faustus; first, as a basis for the manufacture of talismans, and, second, as what they called 'astral doorways'.

Talismans, material objects supposedly charged with specific forms of psychic force, have a long history. Originally their virtue was held to lie in the materials employed in their manufacture and in the words or symbols carved or written upon them, and in the way in which they were worn on the body; thus to enjoy safety from being struck on the head by lightning one took a piece of serpentine, engraved it with the word ON and carried it under one's left armpit. By the late eighteenth century a more sophisticated view prevailed and the real virtue of talismans was believed to lie in their consecration, the magical processes to which they had been submitted. By the 1890s the members of the Golden Dawn drew their talismans on cardboard and then consecrated them by a complex process designed to imbue them with the type of 'spiritual energy'¹¹ symbolized by the designs drawn upon them. Such designs were sometimes original and would incorporate the geometrical figures of geomancy, the colours corresponding to the desired force—the Golden Dawn employed four elaborate systems of colour correspondences—and Hebrew versicles drawn from the Old Testament. On other occasions the design would be a traditional one—perhaps one of the talismanic drawings from the *Key of Solomon*, perhaps one of the lettered Abramelin squares or, on occasions when the desired force was perhaps a little sinister, one of the sigils of the *Armadel*.

Only a minority of Golden Dawn members and their present-day admirers have been serious practising magicians. The majority have studied the theory, they have manufactured magical robes and implements, they may even have taken part in the occasional invocation, but they have not engaged in the regular performance of the time-absorbing and emotionally exhausting techniques of ritual magic. Apart from anything else the sheer expense of it all would have been too much for most of them; consider, for example, the invocation of a 'Mercurial Spirit' by four of Mathers's disciples in 1896. This involved the

¹¹ Examples of such consecration ceremonies may be found in Vol. I, No. 3, of Dr Regardie's recently reprinted *Golden Dawn*. See also the descriptions given in Richard Cavendish, *op. cit.*

purchase and use of such exotic materials as snake-fat, alcohol in which a snake had been preserved, spermaceti and rare gums and spices.¹²

Far more easily practised, and more popular, are and have been Mathers's techniques of the use of 'astral doorways' and 'skrying in the spirit vision'. The practice of skrying—the use of mirrors, ink-pools etc. as a means of obtaining a dissociation of consciousness and visionary experience—is of great antiquity and until the latter half of the nineteenth century its techniques had changed very little in over two thousand years. Take, for instance, the following process described in a Graeco-Egyptian magical text¹³ of the early Christian era: to be wrought by the help of a boy, with a lamp, a bowl. . . .

I invoke thee, O Zeus, Mithra, Sarapis, unconquerable, possessor of honey, Melicerteo . . . appear and give heed to him who was manifested before fire and snow for thou art he who didst manifest light and snow, terrible-eyed-thundering-and-lightning-swift-footed-one. . . . Tell what I enquire of thee. . . . Let the throne of the god enter . . . let the throne be brought in. Then if it be borne by four men, inquire what they are crowned with and what precedes the throne. If he say, They are crowned with olive and a censer precedes, the boy speaks true. . . .

This is perhaps a little obscurely worded, but it seems to mean that a young boy should be used as a medium, that he should attain a dissociated state of consciousness by staring into the rays of a lamp reflected in a bowl of water and that all his visions should be accepted as authentic provided that the first of them was the sight of the entry of the god's throne borne by four laurel-crowned servitors. An almost identical method was described in Lane's *Modern Egyptians* (1846)—a remarkable example of the persistence of the underground magical tradition.

While Mathers was undoubtedly familiar with the Graeco-Egyptian system described above, he derived much of his skrying technique from Fred Hockley, a wealthy book collector who dabbled in mesmerism, claimed the 'power of vision in the Crystal' and was greatly admired by all the earlier members of the Golden Dawn. Hockley believed that either a crystal or a 'magic mirror'—a polished black glass—should be used for a skrying and that to be fully effective

¹² The full rubric of this extraordinary ceremony may be found in *The Equinox*, Vol. I, No. 3. It is also briefly described in Ellic Howe, *op. cit.*

¹³ The text in question was translated into English by C. W. Goodwin and published in 1852 by Deighton Macmillan and Co. of Cambridge under the title, *Fragment of a Graeco-Egyptian Work Upon Magic*. This pamphlet, only fifty-seven pages in length, was greatly valued by Mathers and exerted a major influence upon him. His *Bornless Ritual* for the invocation of the Higher Genius was derived from it, as was Crowley's *Liber Samekh*, originally published as an appendix to his *Magick in Theory and Practice* (now appearing in *Magick*, Routledge & Kegan Paul, 1973).

it should be consecrated to a particular spirit. In 1871 he gave an account¹⁴ of the use of such a consecrated 'black mirror' which he had supplied many years before to a young army officer. The officer had passed the mirror on to a 'seeress' who used it to observe his actions when he was travelling in unexplored lands.

One day my seeress called him into the mirror [said Hockley]. She plainly recognised him, although he was dressed as an Arab and sunburnt, and described what he was doing. He was quarreling with a party of Bedouins in Arabian and speaking energetically to them in Arabic. An old man at last pulled out his dagger and the Lieutenant his revolver, when up rode a horseman and separated them. A long time afterwards the Lieutenant came to me and I told him what she had seen . . . he assured me it was correct in every particular and attached his name to the account I had written down at the time, to certify it was true.

One of the most interesting things about this account is that the lieutenant was R. F. Burton, the young linguist and explorer who was to become the English translator of *The Arabian Nights* and *The Perfumed Garden*. It is likely that the recipient of Hockley's magic mirror was Burton's wife, Isabel, who, in spite of her fanatical Roman Catholicism, remained fascinated until the end of her life by tales of hauntings, witchcraft and prophecy.

It was usual for practitioners of Hockley's type of crystal-gazing to 'see' their visions two-dimensionally, rather as though they were watching a television screen. On occasion, however, the seer would find himself entering into the vision, becoming part of it. This was considered to be skrying of a more advanced sort and occultists considered that the souls of those who experienced it had actually left their bodies.

Mathers was impressed by this type of 'astral projection', which he and his disciples called 'skrying in the spirit vision', but he felt that its main disadvantage was its lack of control—the fact that the seer had little or no power to direct the course and content of his vision. To overcome this he evolved the still widely used technique of astral doorways. That is to say the use of symbols, such as the Tarot trumps or the sigils of the *Armadel*, as devices for auto-hypnosis. The exact way in which these astral doorways were (and are) used is illustrated by the following extracts from a Golden Dawn document.¹⁵

Proceed to contemplation of some object; say a Tarot Trump: either by placing it before you and gazing at it, until you seem to see into it; or by

¹⁴ In his evidence on the subject of spiritualism to the committee of the London Dialectical Society.

¹⁵ The full text of Flying Roll No. IV, the document in question, may be found in *Astral Projection, Magic and Alchemy* (Spearman, 1972).

placing it against your forehead or elsewhere, and then keeping the eyes closed; in this case you should have given previous study to the Card. . . . In either case you should then deeply sink into the abstract idea of the card; being in entire indifference to your surroundings. . . . The vision may begin by the concentration passing into a state of reverie; or with a distinct sense of change . . . do not resist . . . let yourself go. . . .

The document then goes on to describe a vision actually experienced by two Golden Dawn initiates, one of them being Florence Farr, the friend of both Yeats and Shaw. Their 'astral journey' involved them in entering 'a Gothic Temple of ghostly outlines', meeting the goddess Isis, and experiencing the vision of the Holy Grail!

The sigils of the *Armadel* would have been used in precisely the same way as the Tarot card that produced the visions of Florence Farr. Exactly which sigil was used would have depended upon exactly which aspect of the astral world the seer wished to investigate. If, for example, he wanted to know something about 'The Mysteries of the Creation of the World' he would have used the sigil of Phalet and travelled to the appropriate section of the astral plane.

Such were the ways in which Mathers's disciples used the *Armadel*.

It remains only to add, first, that all notes to the body of the text are by Mathers unless prefaced by the words *Additional Note* (in which case they are my own), and, second, that the text of the *Armadel* printed in the following pages is taken from one of the manuscript copies that circulated amongst the members of the Rosicrucian Order of the Alpha et Omega. This manuscript found its way into the collection of Mr Gerald Yorke (whose activities in the field of document preservation have placed many students of the magical revival greatly in his debt) and will eventually be placed in the library of the Warburg Institute.

Francis King

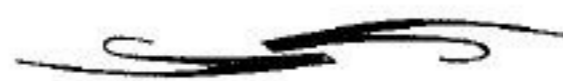

THE MAGIC OF ARMADEL



THE BOOK OF ARMADEL

or

The Most Perfect, Short and Infallible
Science, as well Speculative as Practical
of the Whole

QABALAH
I·H·V·H

The Lord thy God thou shalt fear and Him
only shalt thou Serve all the days of thy
Life, through this Name of Tremendous and
Adorable Majesty.¹

¹ This species of title-page occurs in the original MS. at the extreme end of the book, instead of at the beginning, but I have placed it here as more suitable, while giving the Latin of it at the end.

THE MAGIC OF ARMADEL



Seeing that we possess the explanation of the (Magical) Circle, (let us here state) that it is (Employed) for the Invocation of Spirits, so as to escape the dangers which might arise through their malice. Now it having been duly prepared for you to avail yourself of the Services of the Spirit you desire (to Summon) it is necessary to take heed that you comprehend the power which he hath and whether he can grant you that which you shall demand.¹

Being, then, in the midst of the Circle, wherein you are to perform the Operation, and having made the Character (or Sigil) of the Spirit who shall serve you: you shall see that the Circle be (correctly) formed according to the instructions we have (elsewhere) given. Being then, I say, in the midst thereof, after having recited the *Pater*, an *Ave*, together with the *Credo*, you shall repeat the following Conjunction:

CONJURATIO

*Omnipotens Aeterne Deus, Qui totam Creaturam condidisti in laudem et honorem tuum, ac ministerium hominis, oro ut Spiritum (N.N.) de () ordine mittas, qui me informat et doceat quo illum interrogavero, non mea voluntas fiat, sed Tua, per Jesum Christum Filium Unigenitum. Amen.*²

¹ All this paragraph is somewhat complicated in the original French.

² I have given this Conjunction in the Latin of the MS. as some students may prefer to use it in that language.

TRANSLATION OF THE FOREGOING CONJURATION

O Eternal Omnipotent God, Who hast formed every creature unto Thy praise and honour, and for the Ministry of Man: I beseech Thee to send unto me the Spirit (here give the name of the Spirit) of the (here give the name of of class or Order of Spirits) Order, who may inform and teach me concerning those things which I shall demand of him, nevertheless not my Will, but Thine, be done, through Thine Only-begotton Son Jesus Christ. Amen.

Having obtained from the Spirit that which you desire, you shall licence him to depart in these words:

THE LICENCE TO DEPART³

Quia Placide et quiete venisti, et hac petitione mihi respondisti, ago Deo gratias in Cujus Nomen venisti, ite in pace ad loca tua et rediturus ad me cum te vocavero per Christum Dominum nostrum. Amen.

TRANSLATION OF THE FOREGOING LICENCE TO DEPART

Seeing that peaceably and in quiet thou has come, and hast made answer unto me in this (my) petition, I return thanks unto God, in Whose Name thou hast come. Depart hence in peace unto thine habitations, and be thou ready to return whensoever I shall have called thee. Through Christ our Lord! Amen.

After having repeated this Conjunction three times, if so be that the Spirit appeareth not unto you, you shall repeat the present (following) Conjunction three times. And these Conjunctions should be written out on virgin parchment, together with the Licence to Depart.

THE CONJURATION⁴

I (N.N.) do Conjure thee (O Spirit N.N.) by the virtue of the Great and Holy Names of God, that immediately and without delay thou art to appear unto me under an agreeable form, and without noise, nor injury unto my person, to make answer unto all that I shall command thee; and I do conjure thee herein by

³ I have here likewise given this 'Licence to Depart' in the original Latin.

⁴ This Conjunction is not given in the Latin in the original MS., but only in French.

the Great Name of the Living God, and by these Holy Names:

EL ELOHIM ELOHO ELOHIM SEBAOTH ELION EIECH ADIER
EIECH ADONAY JAH SADAY TETRAGRAMMATON SADAY AGIOS O
THEOS ISCHIOS ATHANATOS AGLA ⁵ Amen.

After having performed this Conjunction three times following, it is necessary to continue the same for three days successively, in the same place, and at the same hour.

And when (your desire shall be) satisfied, and having obtained from him that which you wish, you must licence him to depart (saying):

'Go in peace unto the place which hath been destined unto you from all Eternity; let there be peace between us and you!'



⁵ El (Hebrew), is God the Mighty One.

Elohim (Hebrew), is The Gods, the God and Goddess, who are the Father and Mother of all, the Great Mother Goddess.

Sebaoth (Hebrew), should be Tzabaoth, is Hosts or Armies.

Elion (Hebrew), is God the Mighty and Living.

Eiech Adier Eiech (Hebrew), should be Ehyeh Asher Ehyeh, is the Name of God signifying 'Eternal Life', ill rendered by the translation 'I am that I am.'

Adonay (Hebrew), should be Adonai, is Lord.

Jah (Hebrew), cf. the passage in the Psalms, 'Praise Him in His Name Jah.'

Saday (Hebrew), should be Shaddai, is God the Shedder or Dispenser.

Tetragrammaton (Greek), is fourfold writing, a mode of indicating the Name of four Letters, which we usually call Jehovah.

Agios (Greek), is Holy.

O Theos (Greek), is God.

Ischios (Greek), is Strong.

Athanatos (Greek), is Immortal.

Agla (Hebrew), is formed from the initials of a sentence meaning 'Thou O God, art mighty for ever!'

THE THEOSOPHY OF OUR FOREFATHERS OR THEIR SACRED AND MYSTIC THEOLOGY



by
ARMADEL¹

¹ In the MS. this title-page is blank, so I have supplied this text of a title. As in the case of the first title, the design is evidently intended to represent a door; the Portal of Wisdom, as it were.

THE THEOSOPHY OF OUR FATHERS



AS REGARDETH THE PLANETS THE SANHEDRIN

ZADKIEL will teach unto you all the Sciences Active and Passive, with a remarkable facility, with all honesty and courtesy, together with every kind of benediction. They who avail themselves hereof will possess all things in content. He is to be invoked on a Monday and in the Morning. His Character is this (see Figure 1)

ZADKIEL

Red



Red

FIGURE 1

In this Sigil is taught the method of joining together Actives and Passives, or in everything the manner of modesty and grace. In the which Numbers the Lord God doth sanctify these Planets, so that they may work marvels, and as it were portents, through such Numerations.¹



THE CIRCUMCISION OF JESUS AT NAZARETH

The Prophet of the Greatest One; or the Languor of the Nature.

THAVAEI. This Spirit had a particular care of our Lord Jesus Christ. It was he who conducted the Holy Virgin and Saint Joseph into Egypt when they were fleeing from the persecution of Herod. He giveth unto us a perfect knowledge of all the simples and their virtues. He can be invoked at any time. His Character is thus (see Figure 2).

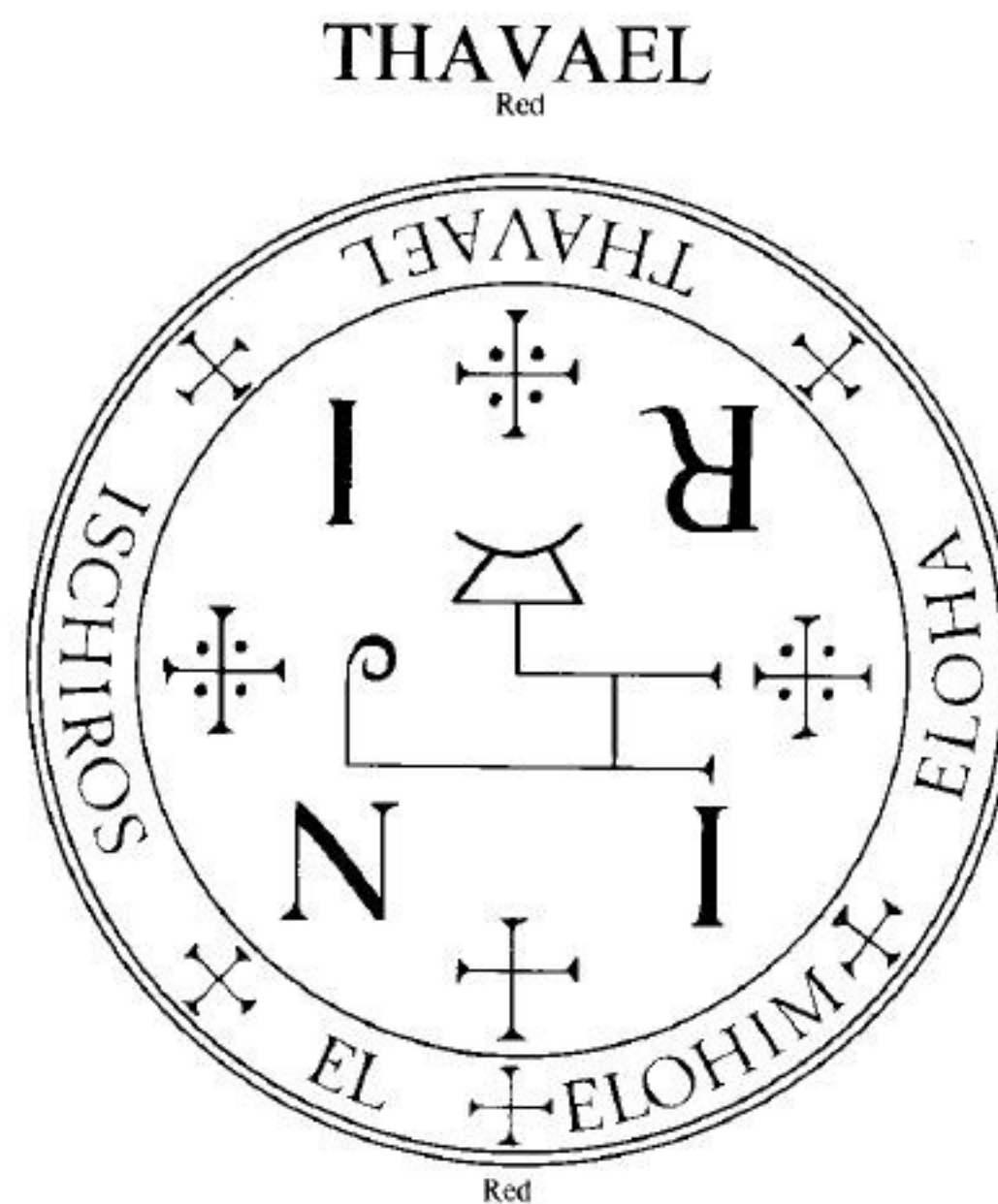

FIGURE 2

¹ In this and the following descriptions of the Offices of these Spirits, the first paragraph is in French, and the second in Latin, the latter being not always either particularly classical or easy of translation.

By the Numbers above referred to are to be understood their mystical values and symbolism according to the Qabalah.

In this Sigil is taught the planting or the sowing of the Seed of Plants, the comprehension of virtue; there are also (herein) taught the manners of flowering as regardeth Plants, and also those inspirations of virtue and grace which be as it were the fundamental plants of the Qabalistical ART.

They who shall write with the ginger upon the forehead of these letters I.·.N.·.R.·.I, will never die by a sudden death.



BY THE FLOWING OF JORDAN

CAPHAEL is a Spirit who guided St. John in the desert, and when he was preaching the Baptism of Penitence by the River of Jordan where the people were baptized, he filled their hearts with Charity and Benediction. He teacheth an infinitude of matters with facility.

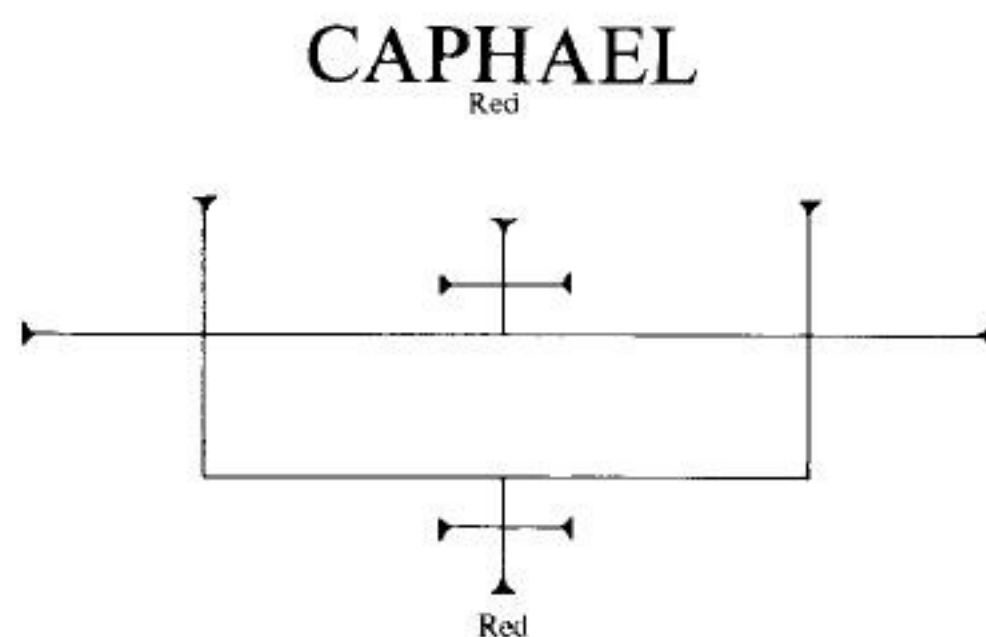
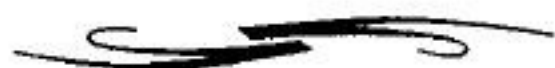

FIGURE 3

In this his Sigil (see Figure 3) there is taught concerning the healing of barrenness and of death concerning the Kingdom of God, and the most ardent Charity; in the which blessed mystical Numbers (of the Sigil) there is taught unto whatsoever Operations this is to be applied, howbeit certain special Operations do fall under the head of certain especial Numbers. Also concerning Sciences and Arts of all kinds and of all perfections whatsoever they may be.

He is to be invoked on Fridays and in the morning.



THE SON OF ZACHARIAS IN THE DESERT

SAMAEL is the Spirit who did never abandon Saint John during the time in which he dwelled in the desert before his preaching. He is the protector of preachers in Missions among foreign nations. He teacheth Theology. He is to be invoked on a Wednesday, and in the morning. His Character is thus formed (see Figure 4).

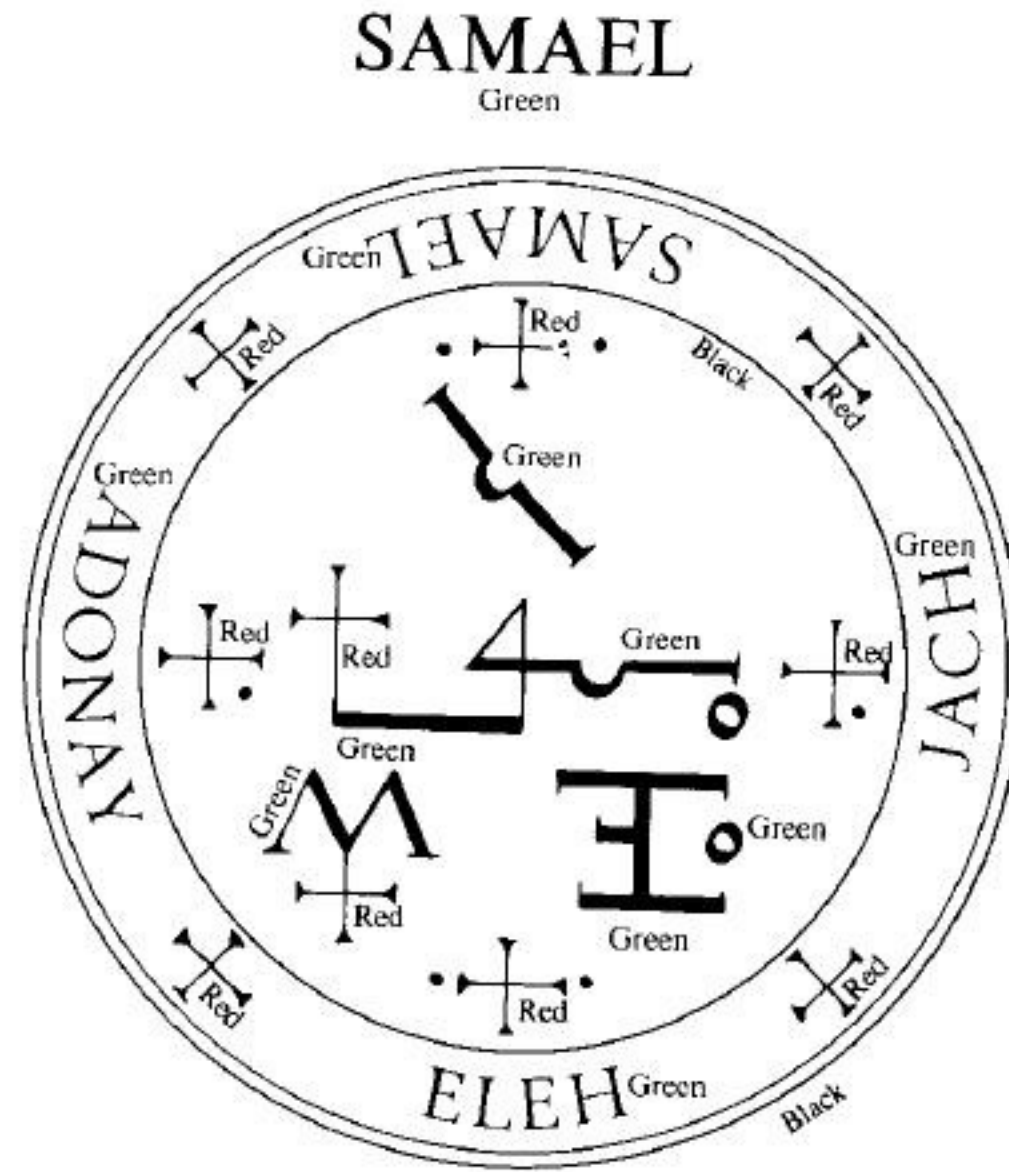

FIGURE 4

In this Sigil is taught the harvest of the Plants of Blessedness, and such harvests; together with the envy of the Kingdom of Behemoth and Leviathan, of the which the Lord God did make use from the Beginning, and preserved (the same) for the production of all creatures, and also in what manner such souls be produced (and come forth).



IN THE FIELDS OF BABYLON

URIEL is a Spirit who did reveal unto the Prophet Esdras every description of Prophecy, he did also aid the Children of Israel in the Camp of the Babylonians. He teacheth natural Sciences, Physic, and Medicine. He is to be invoked on a Wednesday, before daybreak. Thus is his Character (see Figure 5).

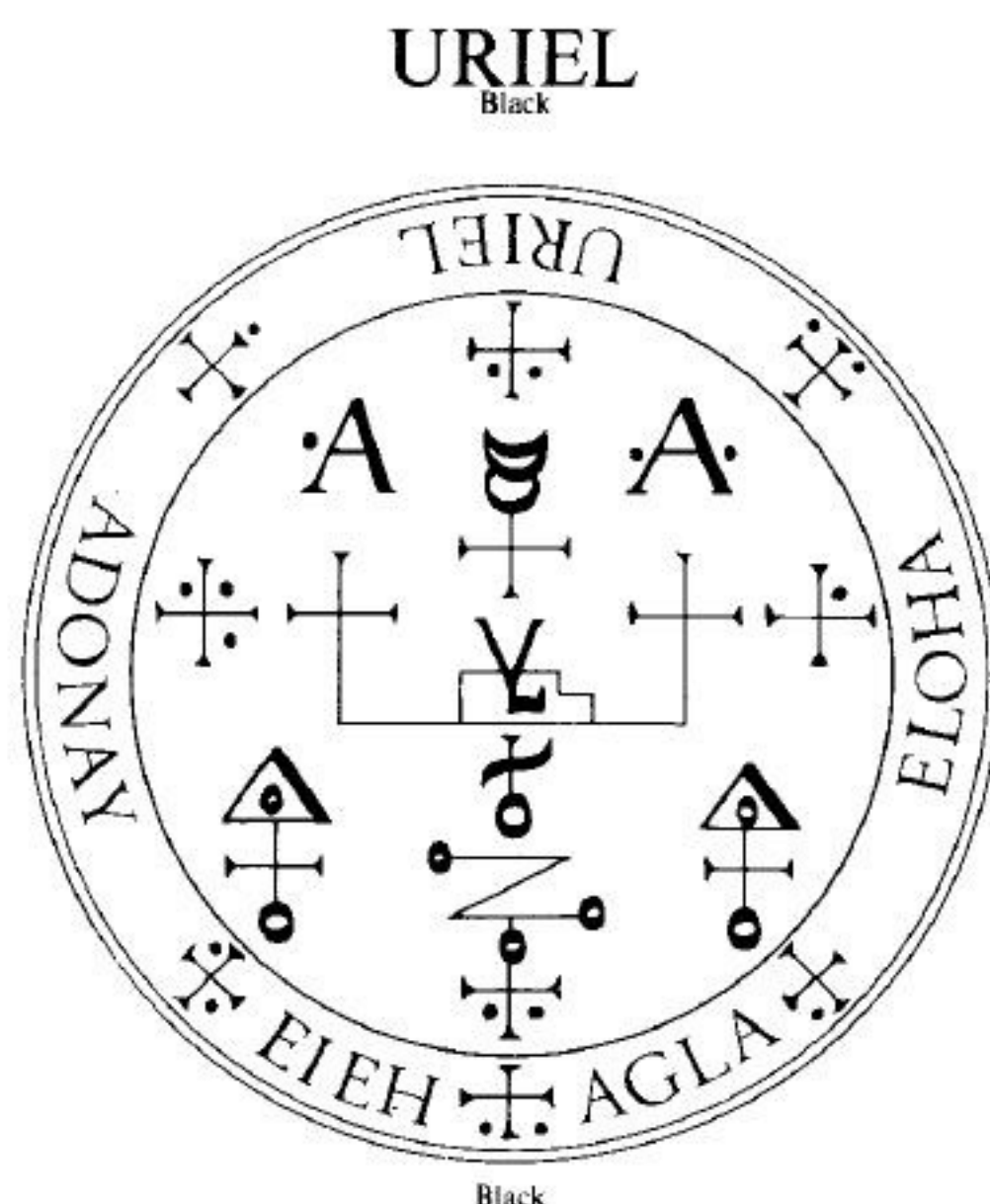
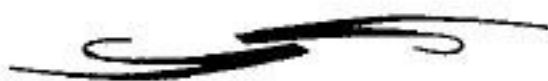

FIGURE 5

In this Sigil there be taught the method of understanding what and of what Kind were those twin Souls (namely) Henoch.¹ The faculties of the Mind and Understanding are purified, and these also in such a manner that they may be exalted from the lowest degree unto that which is most perfect of all. By the which composition also there can be a transmission made of the participating Power or that power of communication of the comprehension of Spirits.



¹ It is noteworthy what is here said concerning the dual nature of Enoch!

THE SPIRIT OF ELISHA

MICHAEL is a Spirit who guided the Prophet Elisha in all his actions. He is the Protector of all Kingdoms. After God Himself, he is almost all-powerful as regardeth those who perform his Invocation, which latter should be worked upon a Sunday, and in the evening. Thus is his Character (see Figure 6).

MICHAEL

Red

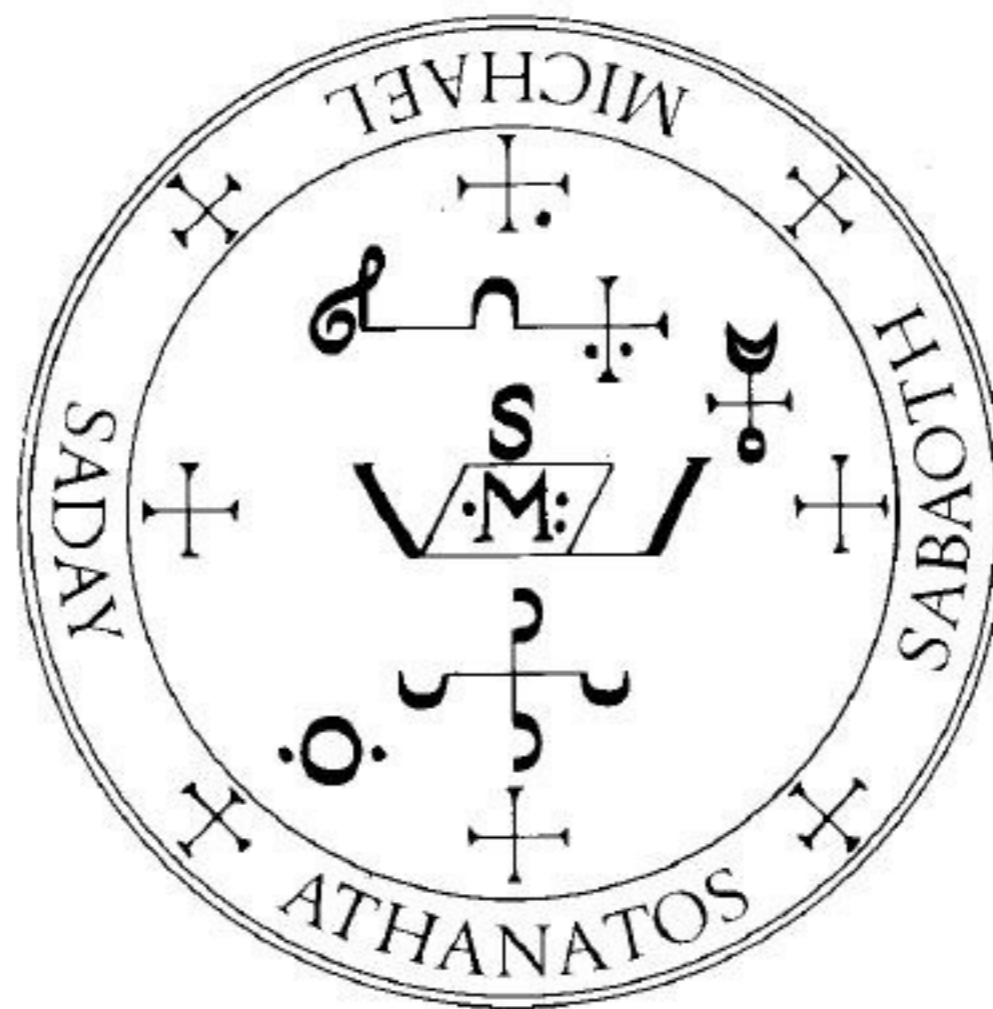

Red

FIGURE 6

In this Sigil is taught how there may be formed a certain composite thing by means of which the faculties and vital Spirits (exist) as well in Man as in other creatures, according to what is necessary for and convenable unto them.



OF THE LIFE OF ELIJAH

GABRIEL is a Spirit who did teach unto the Prophet Elijah all the Mysteries of Divinity. He is to be invoked on a Thursday before Daybreak. His Power is very Great, and he can do you great good, in the which he will instruct you. Thus is his Character (see Figure 7).

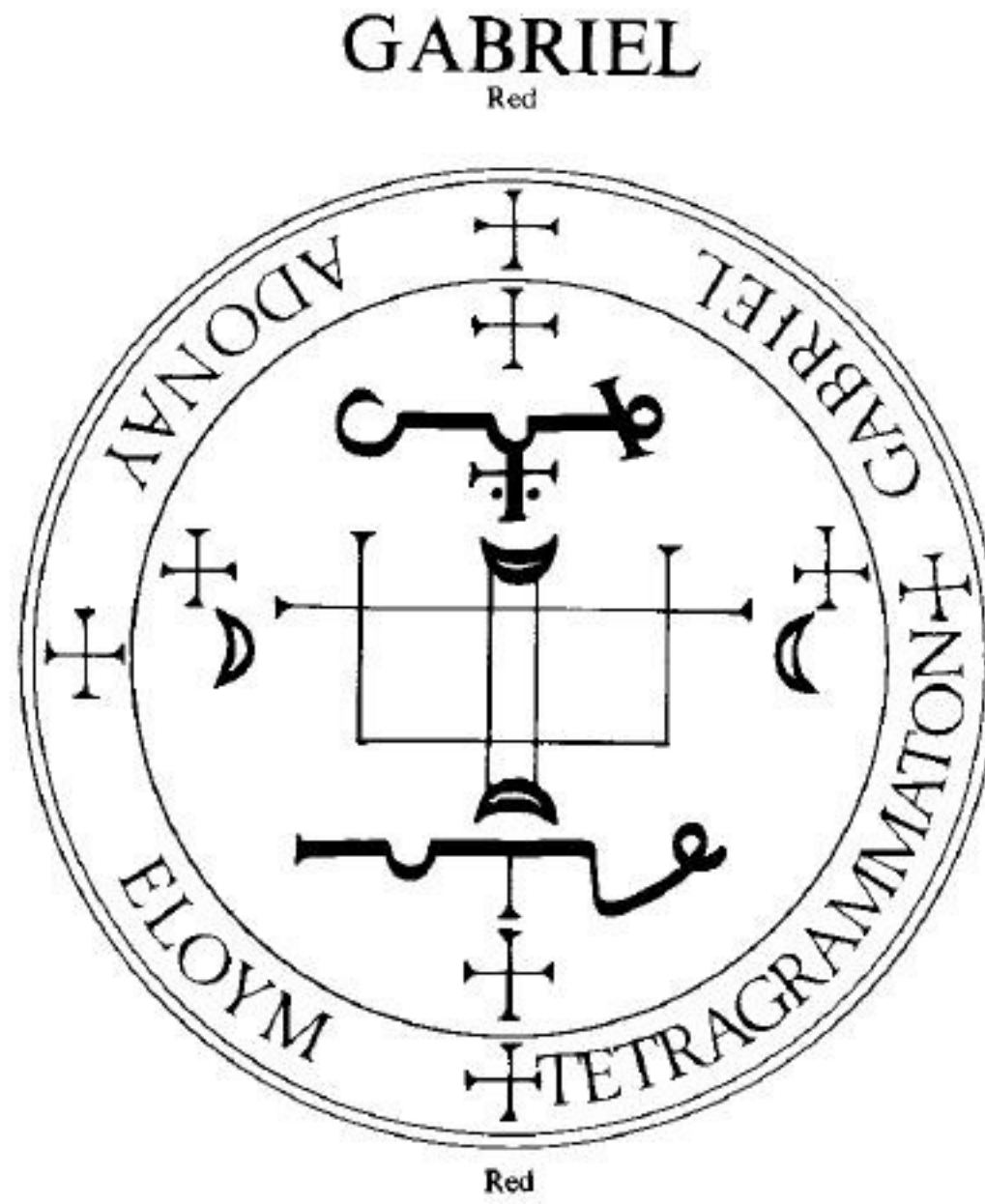
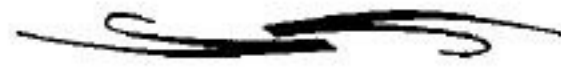

FIGURE 7

In this Sigil there be taught the Methods of restoring and transplanting both health and mental force.¹



¹ The Latin is: Sanitatem et Spiritus.

THE WISDOM OF SOLOMON

RAPHAEL is a Spirit of Science who did teach unto Solomon¹ Knowledge and Wisdom. He is to be invoked on a Sunday before Sunrise. Thou must be both pure and chaste when thou dost invoke him, and thou must have fasted on the previous eve. Thus is his Character (see Figure 8).

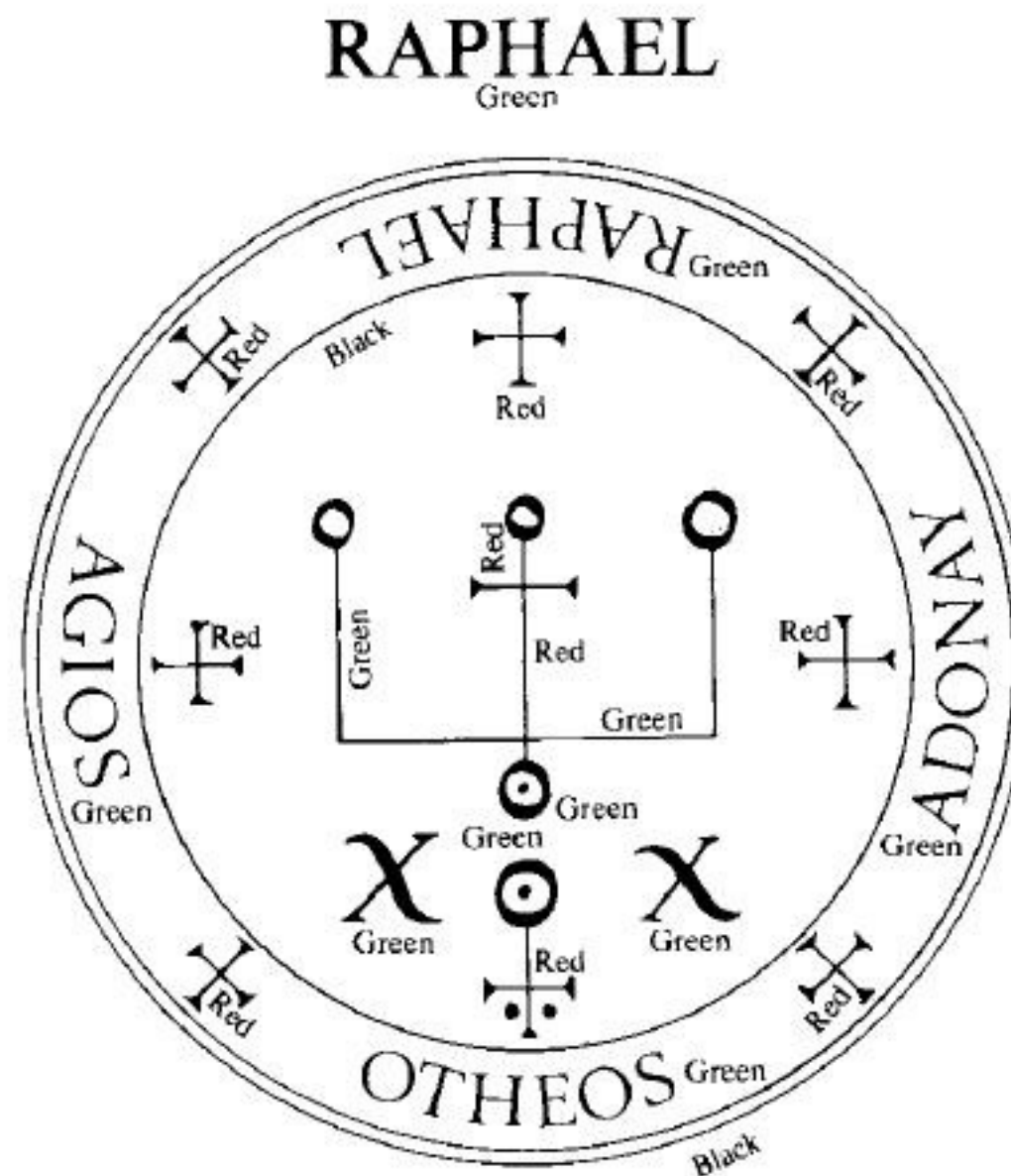
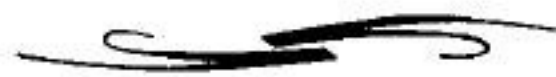

FIGURE 8

In this Sigil is taught the manner of joining Actives and Passives together the one unto the other, in natural things. There is also taught concerning the 'KANSSUD'² of Earthly regions and powers, from one class unto another.



¹ Many Magical Works say that Solomon was taught by the Angels Hamaliel and Michael.

² *'Docetur Kanssud Terrenarum et potestatem de uno capite in aliud.'* This word 'Kanssud' which here occurs in the middle of the Latin is, I think, a contraction for the German 'Sud Kante' and I think must here mean the 'Southern division of our Earth,' or 'the Knowledge of the countries and races South of the Equator,' concerning most of which the civilised Ancients knew very little, or nothing.

THE EXPLORER AND LEADER JOSHUA

HETAEL is a Spirit who guides armies and also can destroy them, as he did unto the enemies of the Children of Israel under the command of Joshua, when by his prayer the latter arrested the course of the Sun. He can render you invulnerable unto every kind of weapon, and can give you Spirits to serve you unto this end. He is to be invoked on a Tuesday. Thus is his Character (see Figure 9).

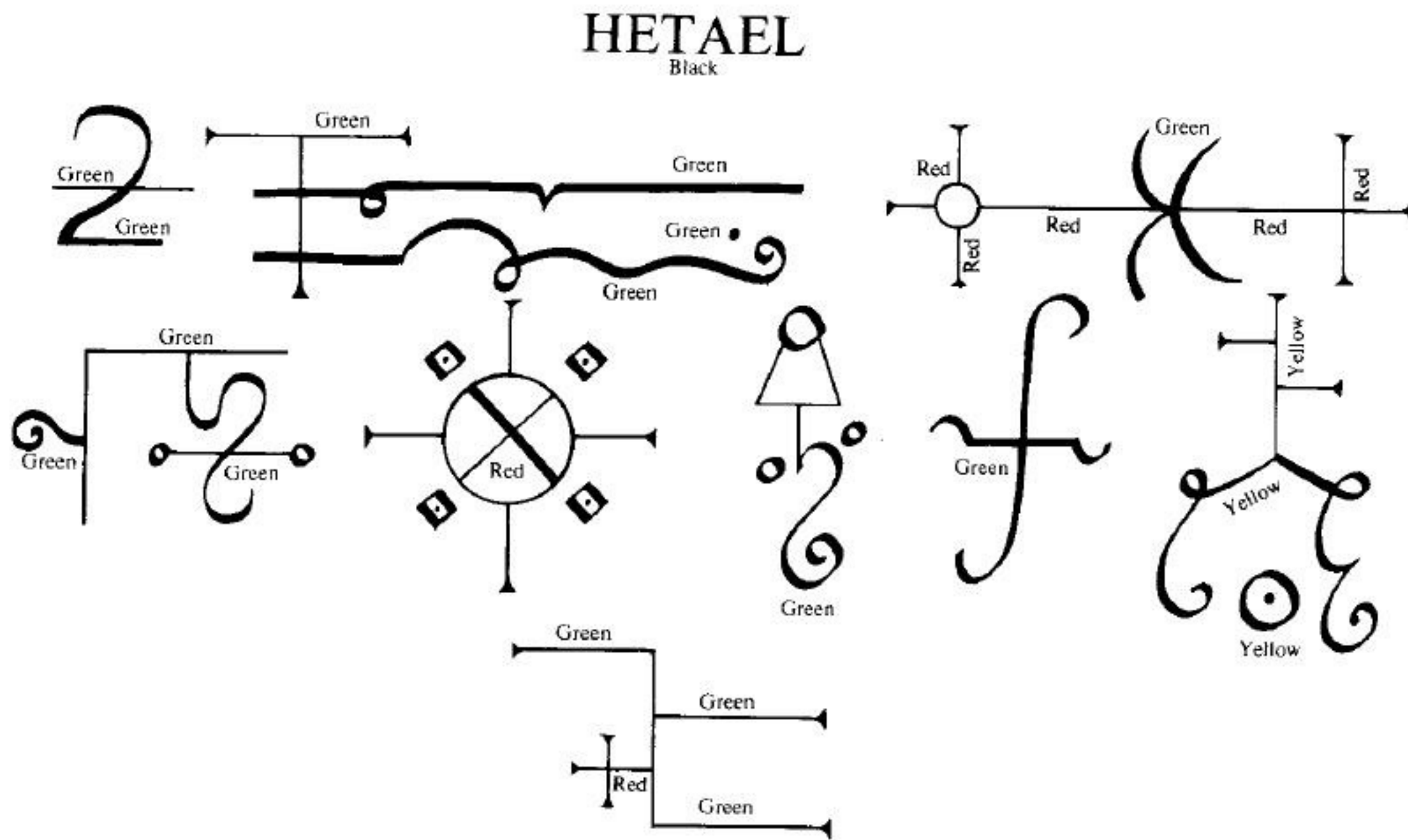

FIGURE 9

In this Sigil there is taught the declaring of the intentions of Enemies and the like. Also there can be expelled all things noxious unto body and mind, and further in like manner this Mystic (Sigil) operateth in their restoration. Also there be Mysteries regarding 'Man'.^{1*}



¹ *In hoc Sigillo docetur enarratio cordium inimicorum et quorum cumque expellenda omnia noxia corporis et animi et restauratione eorum sicut illud misterium operatur docentur quoque misteria Man.*

The Latin is rather obscurely worded. I do not think for a moment that by 'Man' the English word is intended, but perhaps it may be German 'Man' the pronoun 'one'. In this case I should consider here that it most likely means 'personality' but perhaps also the Indian 'Mantra' or Spell is intended.

* *Additional Note* Mathers's suggestion that the word 'Man' might be derived from Mantra betrays his total lack of historical sense! The word is clearly derived from the German and illustrates the *Armadel's* Faustian connections.

THE VISION OF 'MAN'¹

VAU-AEL is a Spirit who causeth all kinds of pleasant visions to appear, such as our Forefathers in the Old Testament beheld. He serveth you faithfully in all that you desire to know. Thus is his Character (see Figure 10). He hath many Spirits under his dominion.

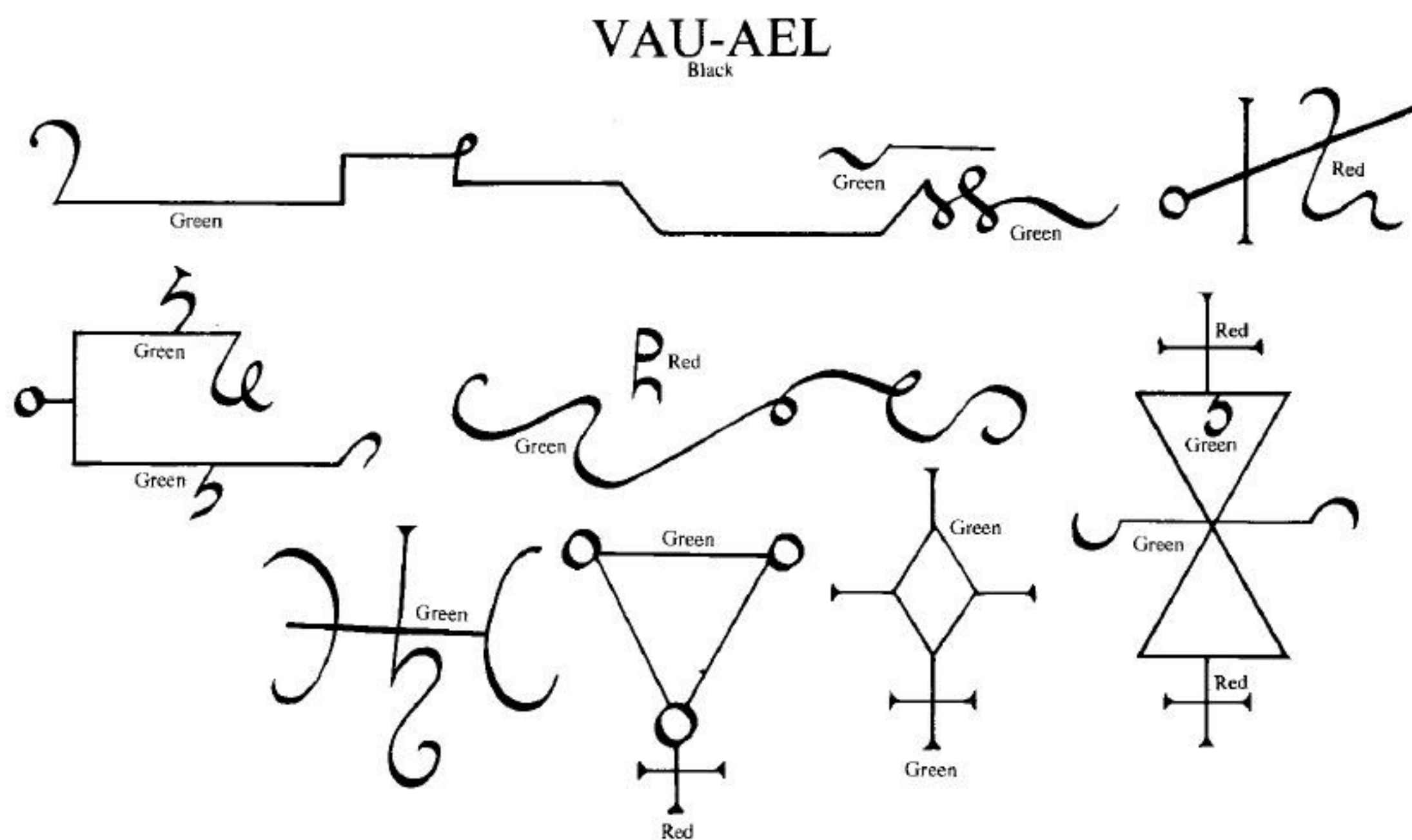
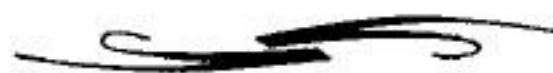

FIGURE 10

In this Sigil, howbeit, there is formed a certain species of 'Man'¹ for castings out.



¹ See note to description of the Sigil of the previous Spirit, Hetael.

THE ROD OF MOSES

ZAINAEL is a Spirit who did teach unto Moses the methods of availing himself of the Rod with the which he did perform so many miracles in Egypt, and among the Chaldeans. He hath much power to render those rich who avail themselves of his services. He can be invoked at any hour. Thus is his Character (see Figure 11).

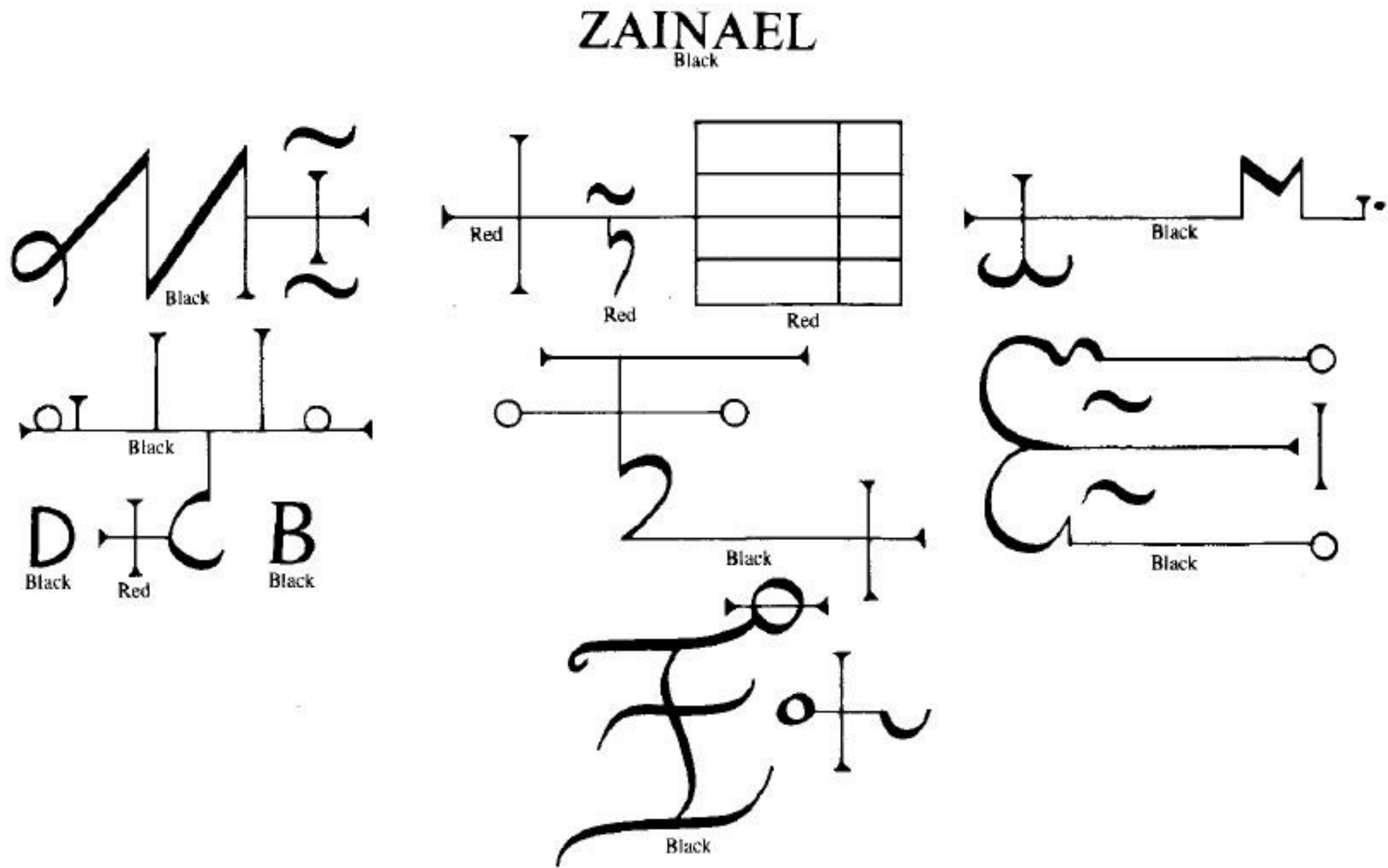

FIGURE 11

In this Sigil is taught the Practice of the Science and Wisdom of the Diviners and Magi of the Egyptians and Chaldeans, and by what ways and means they may be acquired.



MOSES IN THE INTERIOR OF THE DESERT

HETHATIA maketh you see even as Moses saw the benefits which he had received from God, when he was in the Desert of the Land of Midian. He can do much for those who invoke him, but it must not be in the desert place. Thus is his Character (see Figure 12).

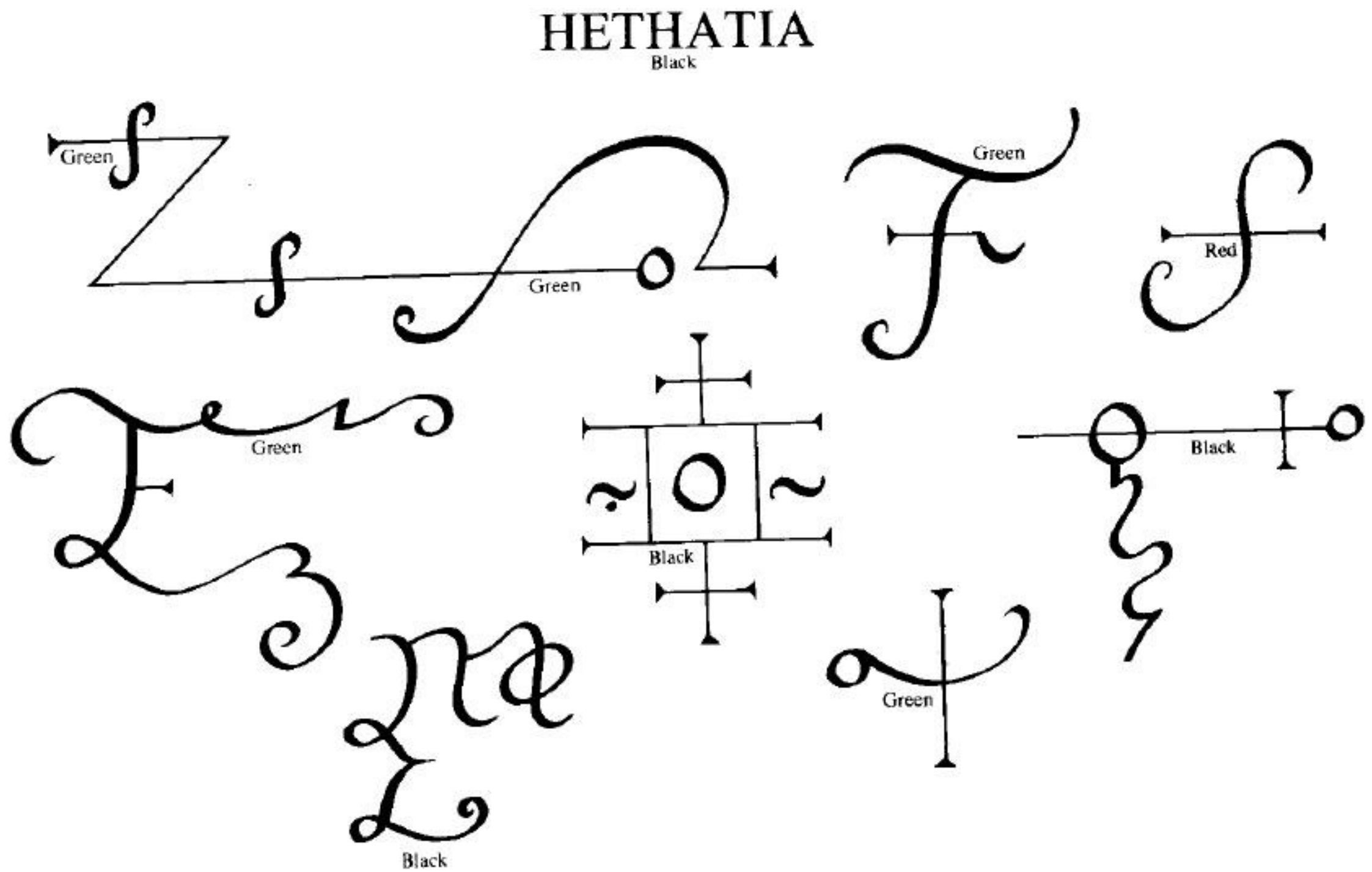

FIGURE 12

In this Sigil is taught the Science and Wisdom of Moses, and the Arcana of the Egyptian Magi and Diviners; perfect happiness and the ways of causing and inspiring fear, and of going forth from a land and for the preservation of a Man in that (case) and place.



THE CAVE OF EPHRON

TETAHATIA is a Spirit of Science and Virtue, who hath preserved our Forefathers from their enemies, rendering them formidable unto them so as to put them to flight. He will do the same unto the Enemies of those who shall wish to avail themselves of his services. Thus is his Character (see Figure 13).

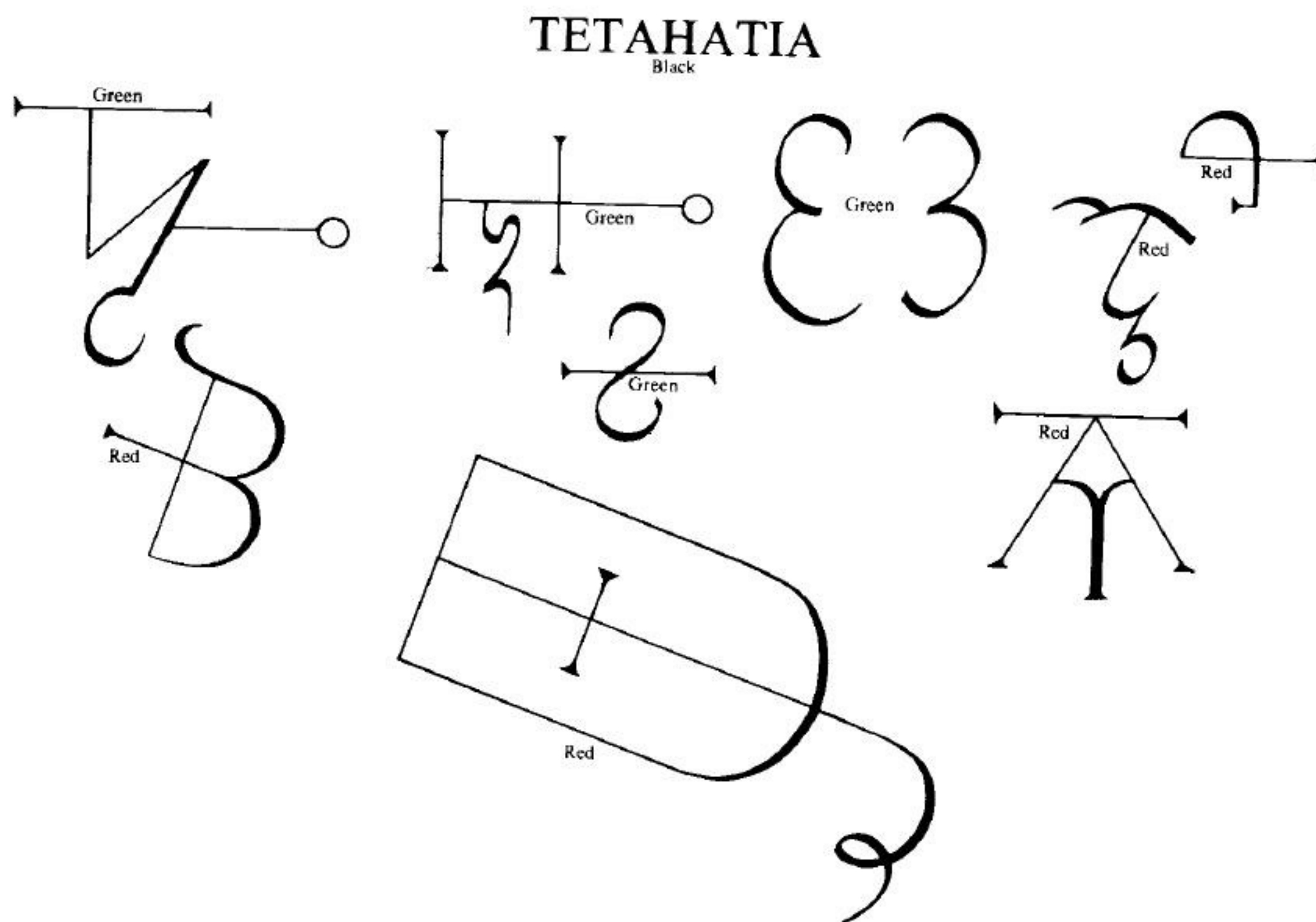

FIGURE 13

In this Sigil be noted the ways whereby a blinding darkness may be produced, or a thing terrible unto one's enemies, also how a blessing may fall hereon.



THE GOING-FORTH OF ABRAHAM FROM UR OF THE CHALDEES AND FROM HARAN

ALEPTA maketh you see how Abraham went forth from Ur from among the Chaldeans, and from Haran. He can give unto you great riches. Thus is his Character (see Figure 14).

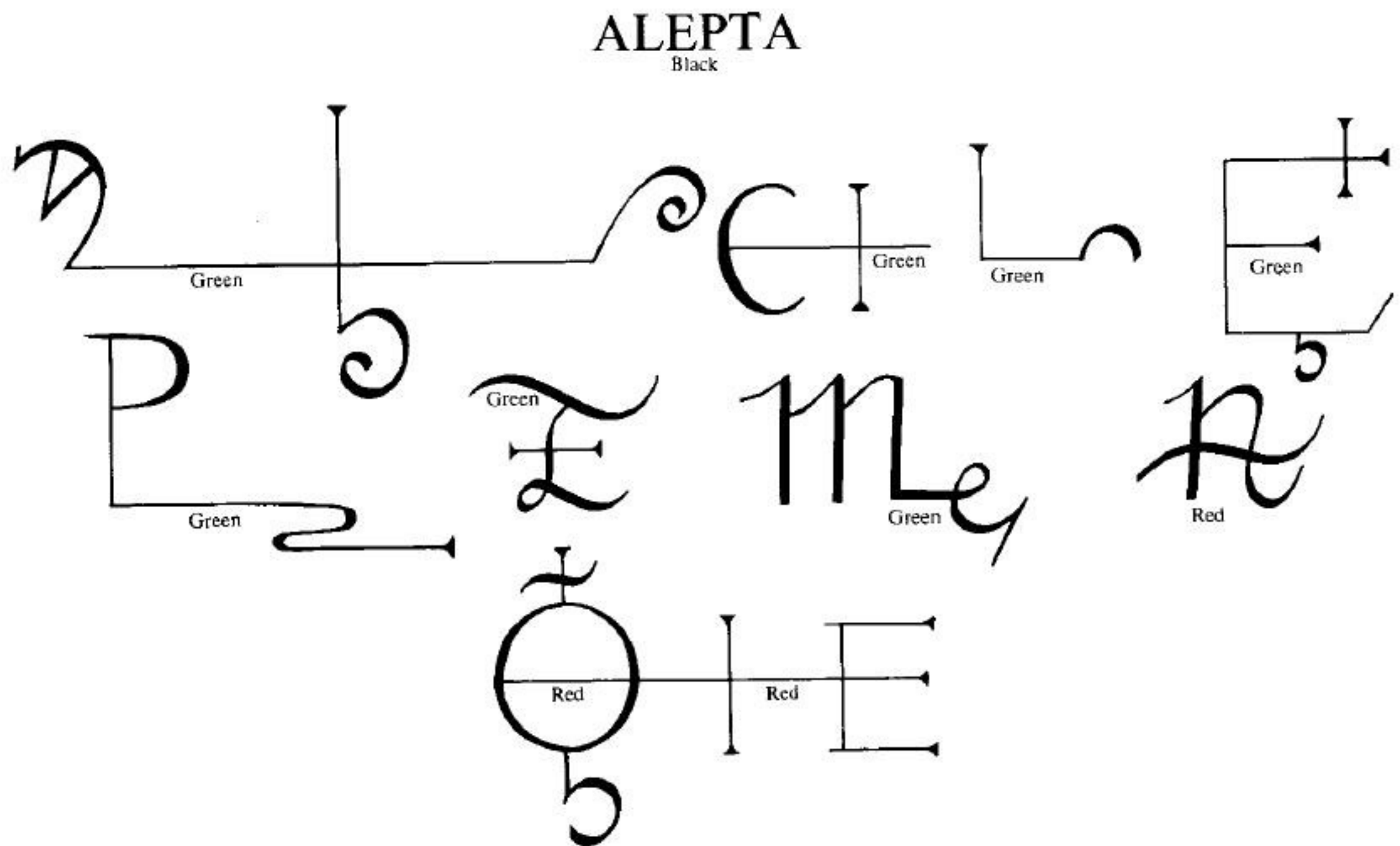

FIGURE 14

In this Sigil is taught how a Man may be exalted, and how a Man may become formidable unto all Creatures, at any hour (and how he may be rescued) whether out of the hands of cruel men, or from a crowd of men.¹



¹ This is the best translation I can give of the crabbed Latin '*Singulis horis ex duris hominibus seu posse hominis.*'

THE WISDOM OF OUR FOREFATHER ADAM

BETEL teacheth unto you the Sciences which God had revealed unto Adam. He is a very docile Spirit who appeareth as soon as he is invoked. (This should be either) in a wood, or in a secluded garden, and one should be alone, whether it be by day or by night. Thus is his Character (see Figure 15).

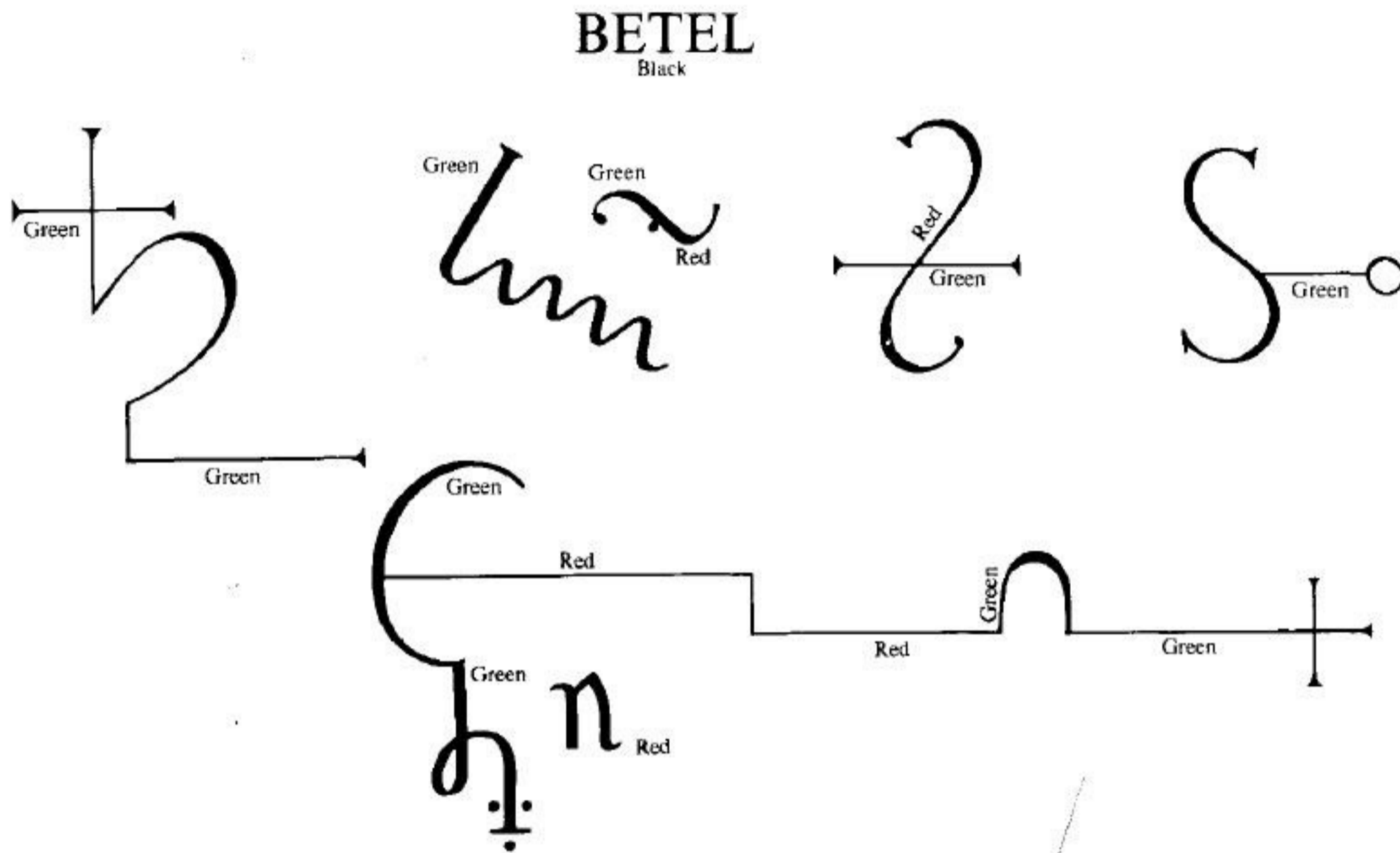
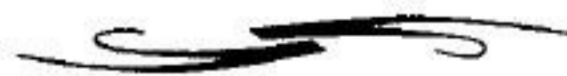

FIGURE 15

In this there is taught in what way we can arrive at the possession of the virtues of all Creatures (or created things); there is (further) taught what and of what kind¹ be the virtues hereof, and what (virtues) be truly most powerful above all virtues of Creatures. There is also taught the reason of the laws² of (such) virtues and of their uses.



¹ In the MS. 'Euales'; I think a slip for 'et quales'.

² 'Latium', I think the word is in the MS. In Latin this means rather an Act, such as an Act of Parliament, than a Law properly so called.

THE BEHOLDING OF THE SERPENT

GIMELA maketh you to know and behold the form of the Serpent who did tempt Eve in the Terrestrial Paradise; (he also) can give unto you some of his Spirits who can transport you from one place to another and can even make you travel at the speed of an hundred leagues in an hour. Thus is his Character (see Figure 16).

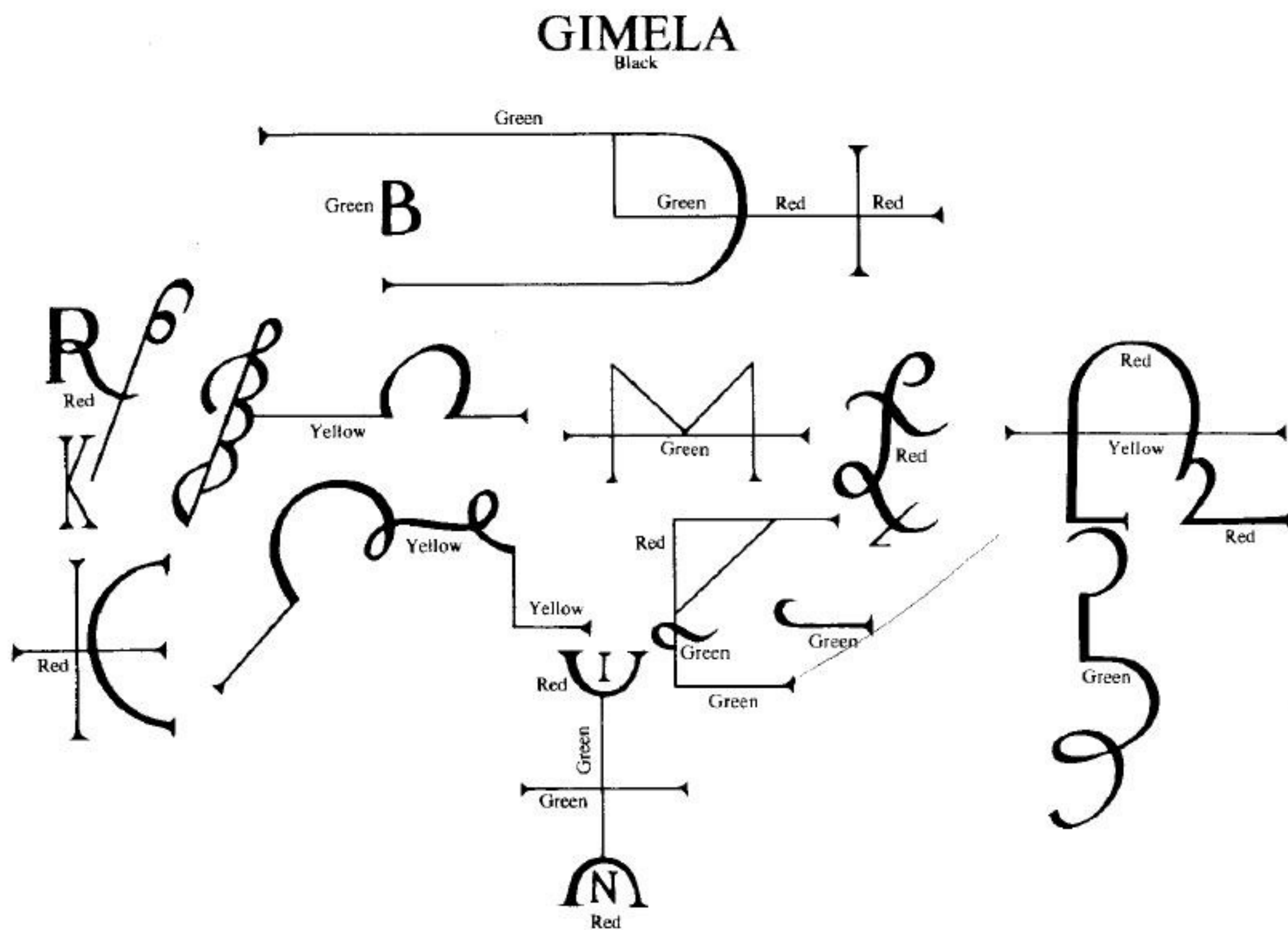
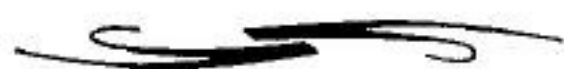

FIGURE 16

In this Sigil there be taught all the Mysteries which the Lord is willing to allow to be worked by the Serpent and from the Serpent; what may be his corporeal moulding or proportion, and whether he can contain in himself all invisible beings (or creatures) and in what manner.



THE VISION OF FORMATION—ADAM

DALÉTÉ is a Spirit who will show unto you the Visions which Adam beheld while he was upon the Earth. He hath many Spirits under his leadership, who will teach unto you many things if you tell unto them that which you shall desire. Thus is his Character (see Figure 17).

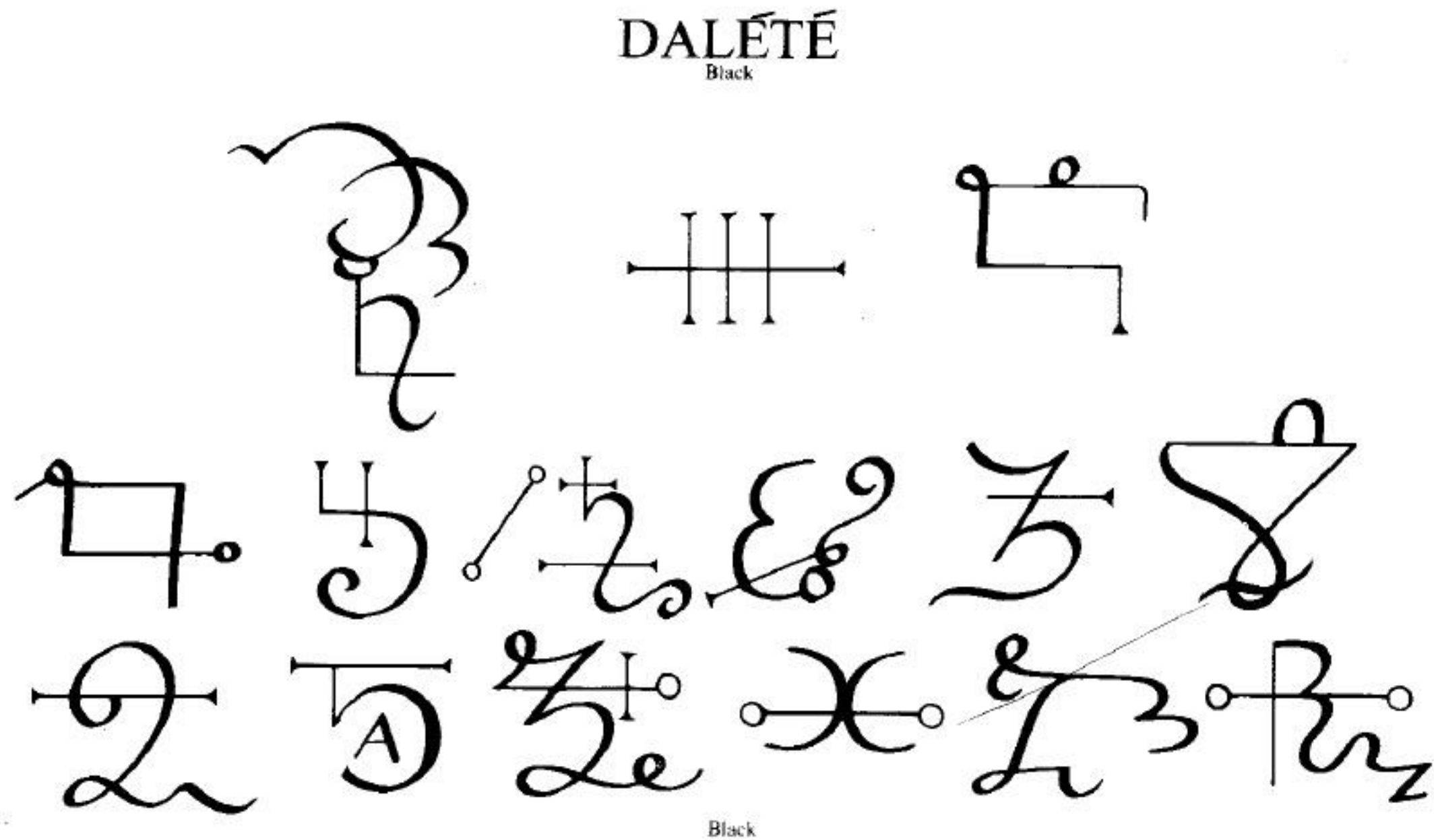

FIGURE 17

In this Sigil be taught and demonstrated the Mystical Formation of Adam; what Animals were in the Lord¹ and brought in this place unto Adam by the Lord God.



¹ i.e., symbolically included in the Name IHVH and its power as distinct from that of the Evil Spirits and Demons.

THE VISION OF EDEN, OR OF THE TERRESTRIAL PARADISE

PHALET will teach unto you all that did happen in the Terrestrial Paradise, from the time of the Creation of Adam and Eve. There be many Spirits under his leadership who can do much in the manner of serving you, and in many ways. Thus is his Character (see Figure 18).

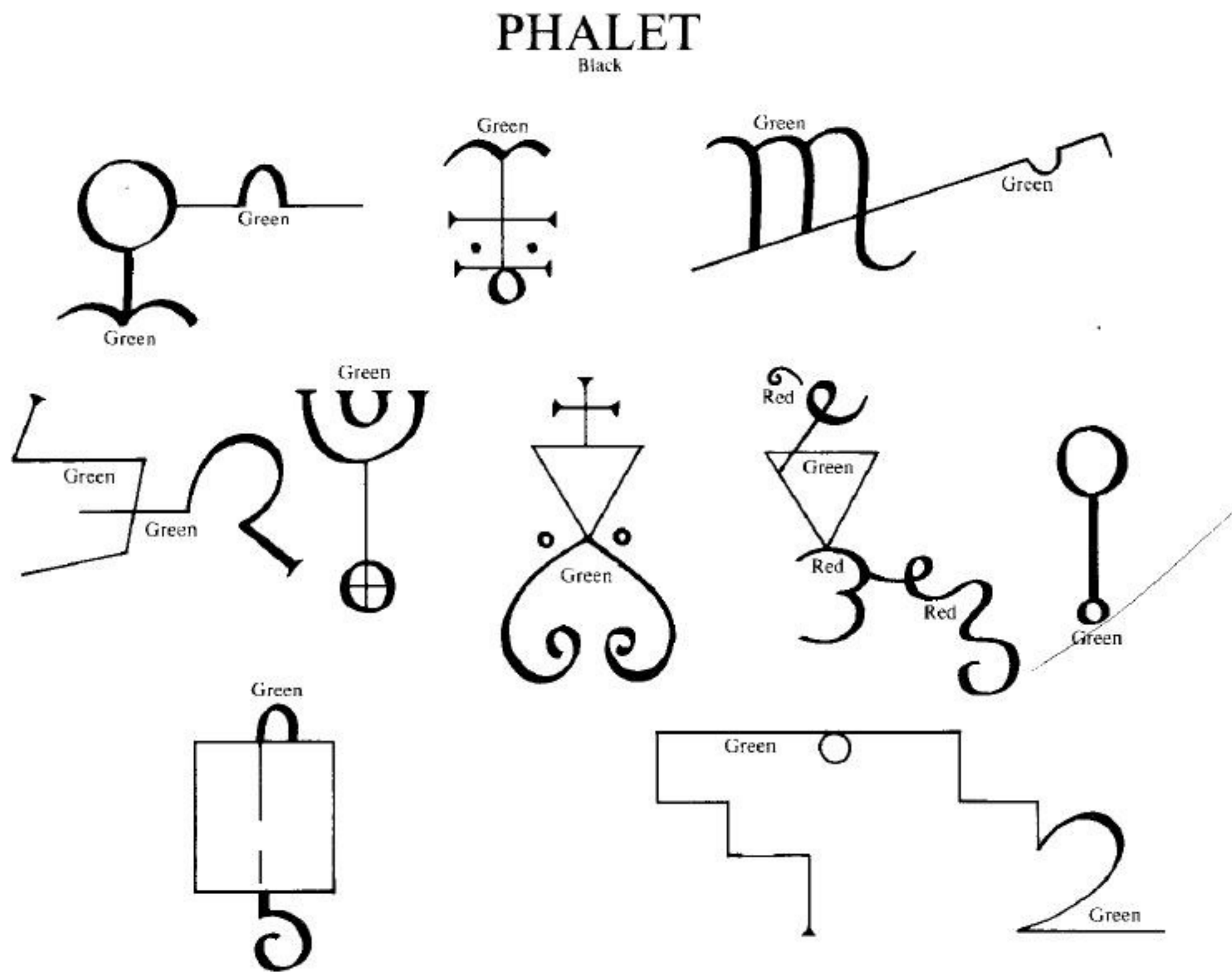

FIGURE 18

In this Sigil there be taught the Mysteries of the Creation of the World, and of all Creatures, and what (of these) be sacred; but also how those (creatures) are proper to be detested for superstitious reasons when they draw their origin from Corpses of the dead, and from collections thereof, and from sepulchres; and thence also is the arising of every kind of superstitions. In this Sigil be (also) taught all the Arcana of Necromancers and of Diviners of that same class,¹ and whence in a Scientific (sense) these (arts) take their rise.



¹ i.e., those who Divine by means of the dead. This whole paragraph is in atrocious Latin and very obscurely worded.

CONCERNING PHITONE¹ OR THE ABUSES OF NECROMANCY

SAMAEL is a spirit of Counsel. He teacheth you Magic, Necromancy, Jurisprudence, and all the Occult Sciences, with facility. He is to be invoked on a Tuesday at Midnight, care being taken to fast the day that you shall wish to avail your self of his services. He hath much in his power, and on your demand he will tell you the extent thereof. Thus is his Character (see Figure 19).

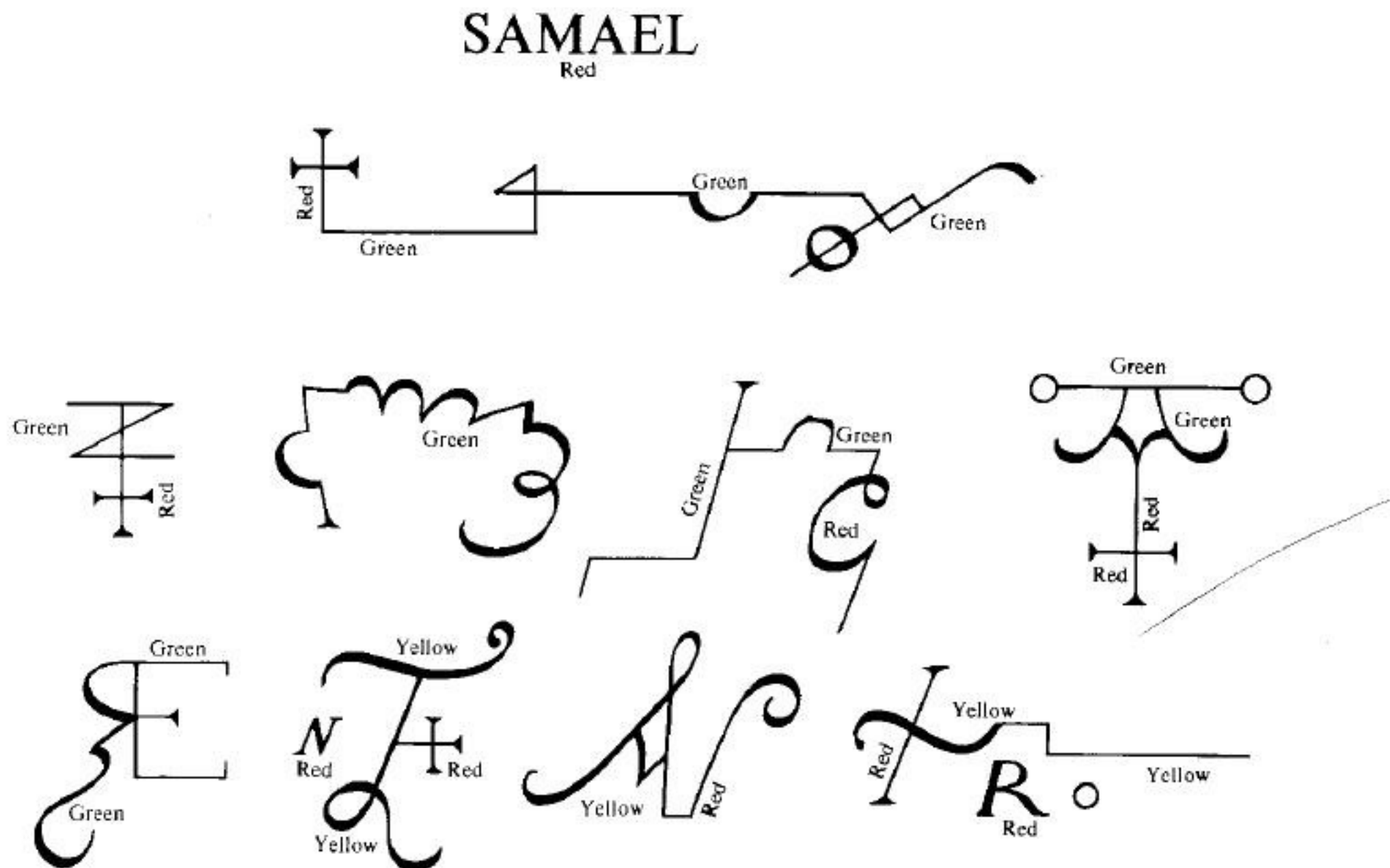
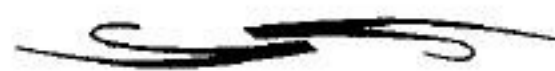

FIGURE 19

In this Sigil there be taught what are all the abuses of Necromancy which may expose a man (to danger) through such communication; whether such communication may have such virtue as to link you unto the Angels and unto God, and to confer upon you power over all creatures, or the union of the love of all beings with the most profound and familiar knowledge of them, or whether it may join us unto the *Devil* even as in our mortal familiar (relationships) so can we be linked with all things which may be pleasing unto us. There is also taught (herein) how such communications may be formed.²



¹ Probably an error for 'Pythene' the Ablative case of the Latin word 'Pythe' or 'Pythen', meaning the Spirit of Necromantic Divination. See *Acts of the Apostles*.

² This whole paragraph is in very obscure Latin and without the slightest punctuation.

CONCERNING THE COMMUNICATION OF THE GENII

CAMAEL giveth unto you a perfect knowledge of your Genius, who will have the power to grant you everything that you shall demand of him. There be many Spirits under the rule of (Camael) who can serve you in many things, and especially such as you shall demand of them. Thus is his Character (see Figure 20).

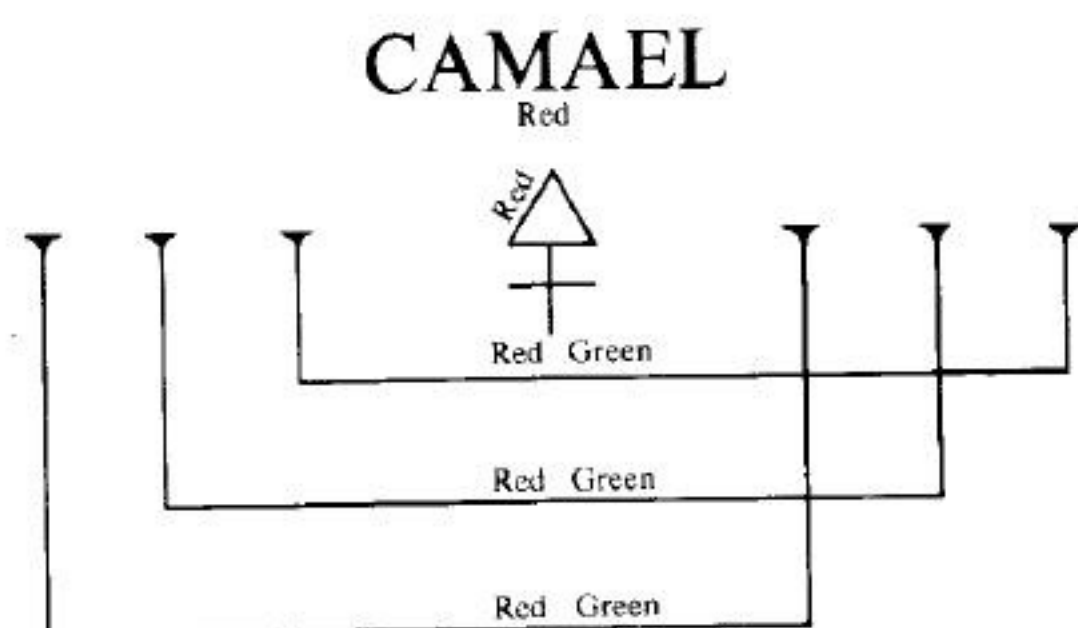

Characters of the Spirit which be under the
domination of CAMAEL

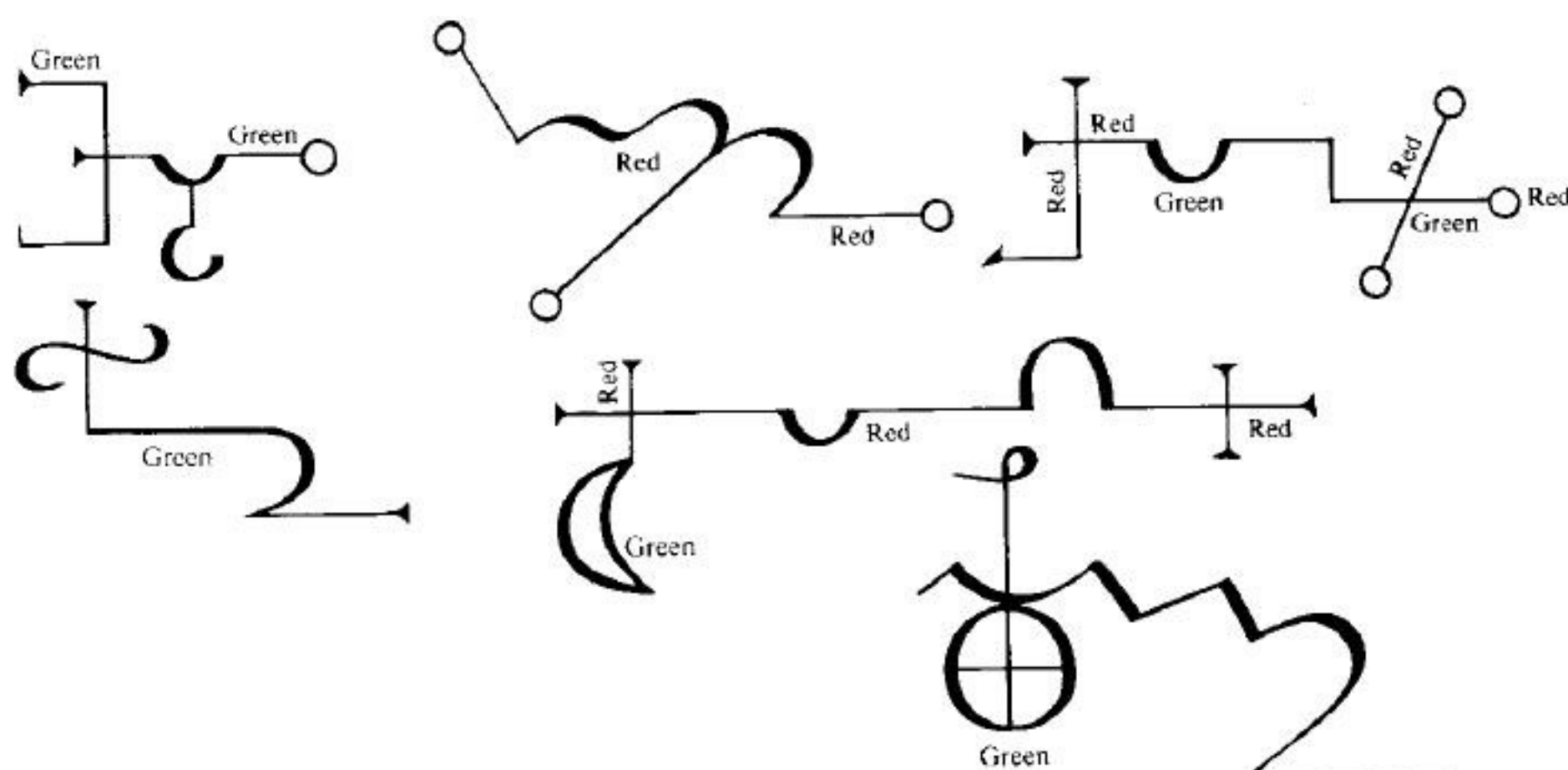
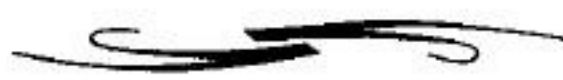

FIGURE 20

In this Sigil is taught what and after what manner may be this communication of the Genii; (transforming in us) our evil (qualities) into good, and our good (qualities) into better and best; there is also taught the method of such transformation. Wherefore adore the Lord God and love thy neighbour!



CONCERNING THE TRANSFORMATION OF THE GENII

HANIEL teacheth unto you the transformation of all precious stones and giveth unto you as many as you wish thereof. He is to be invoked on a Friday before daybreak. Thus is his Character (see Figure 21).

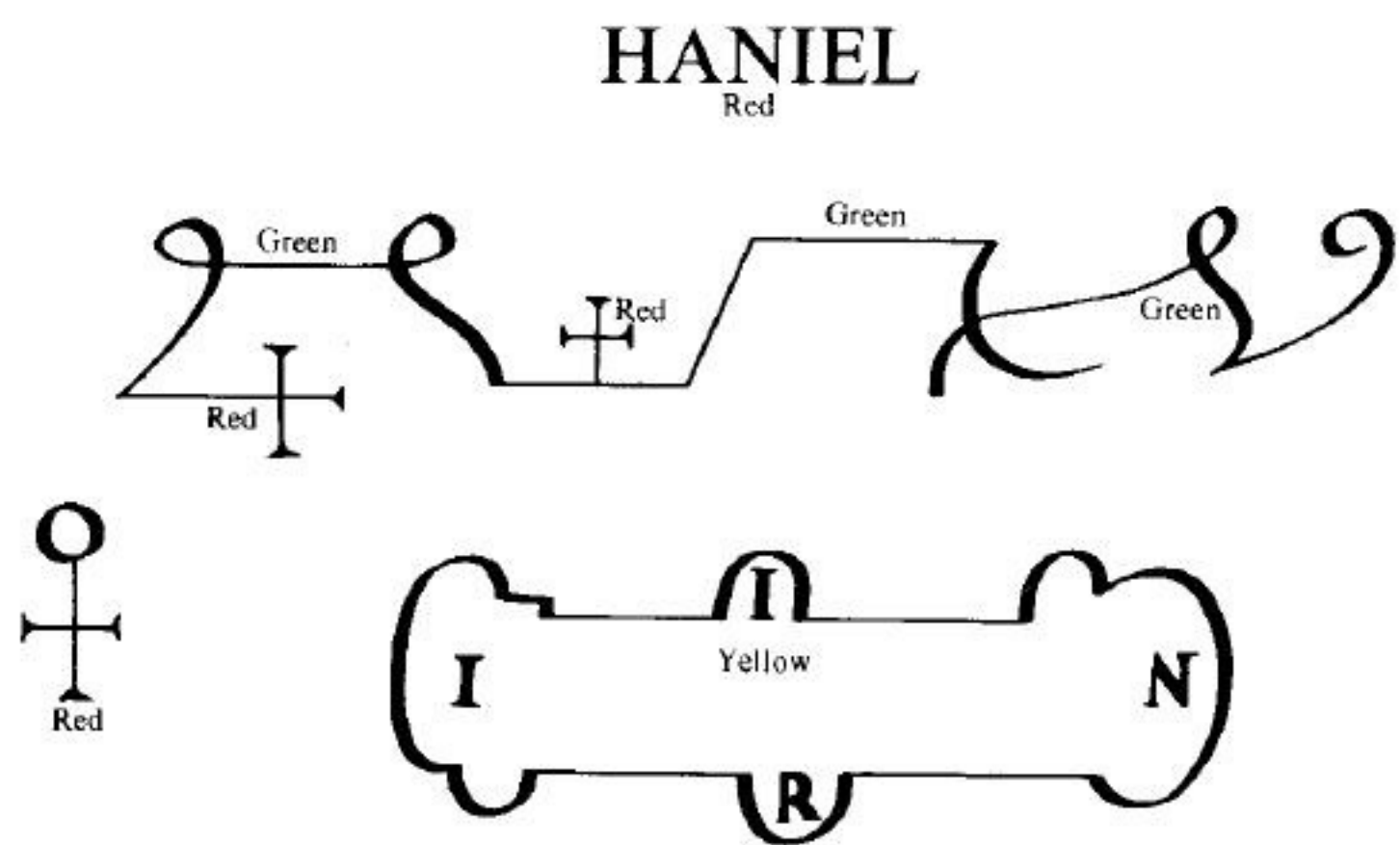

Characters of the Spirits which be under HANIEL

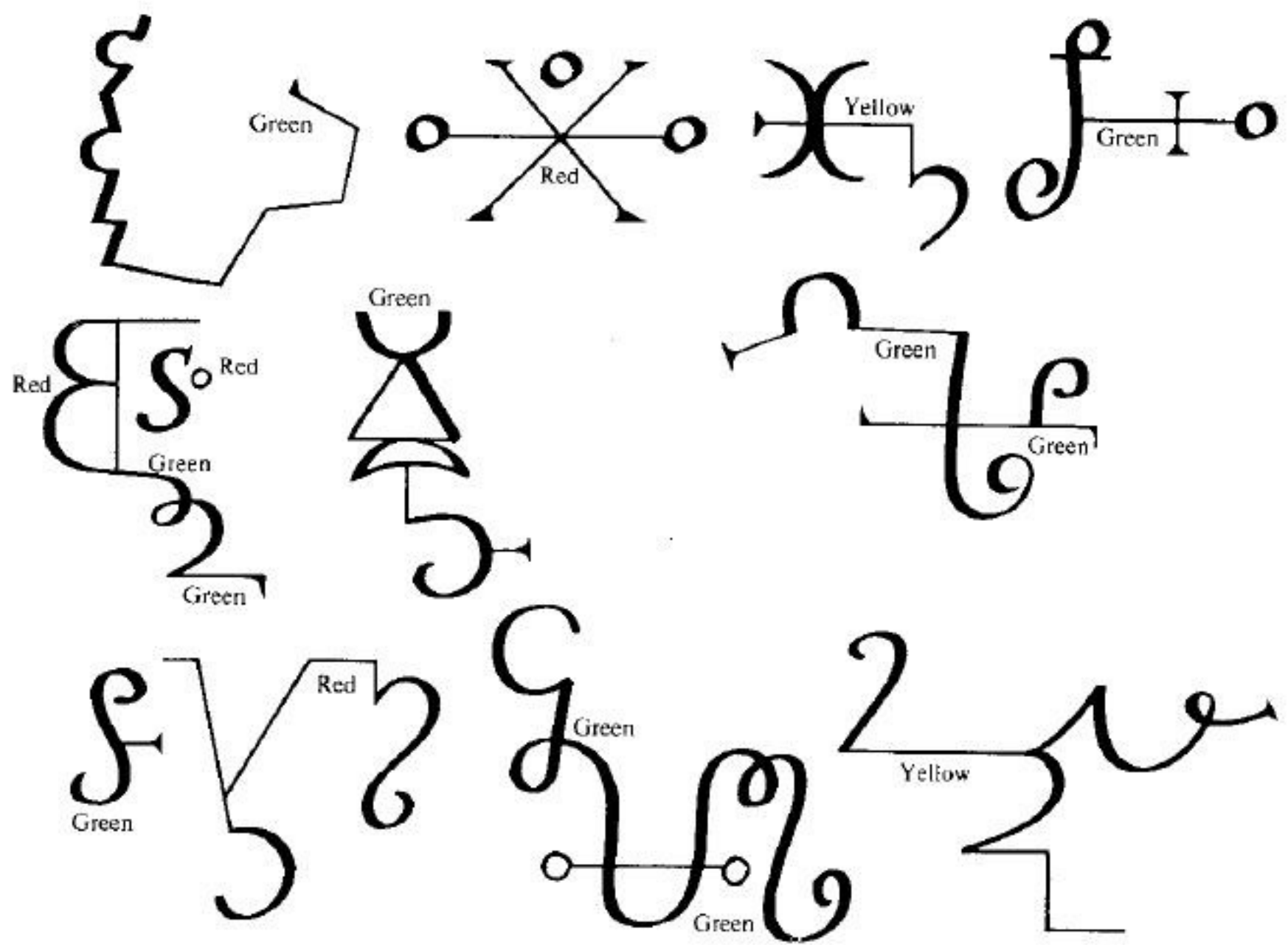
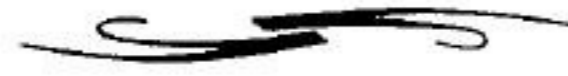

FIGURE 21

In this seal there is taught how Genii may be transformed into Man. They can pass from him into their nature, and correspond unto him in the compounded elements. There is here also taught how such may be necessary unto the Human Race. Also the necessity of such a Mystery.



CONCERNING THE NATURE OF THE GENII

ANAEL is a Spirit which will give unto you the Knowledge of all things which he in the Order of Nature (understands), for he is a Spirit of Power, who appeareth speedily if he shall be invoked on a Sunday at Daybreak by one who is alone and in a retired place. Thus is his Character (see Figure 22).

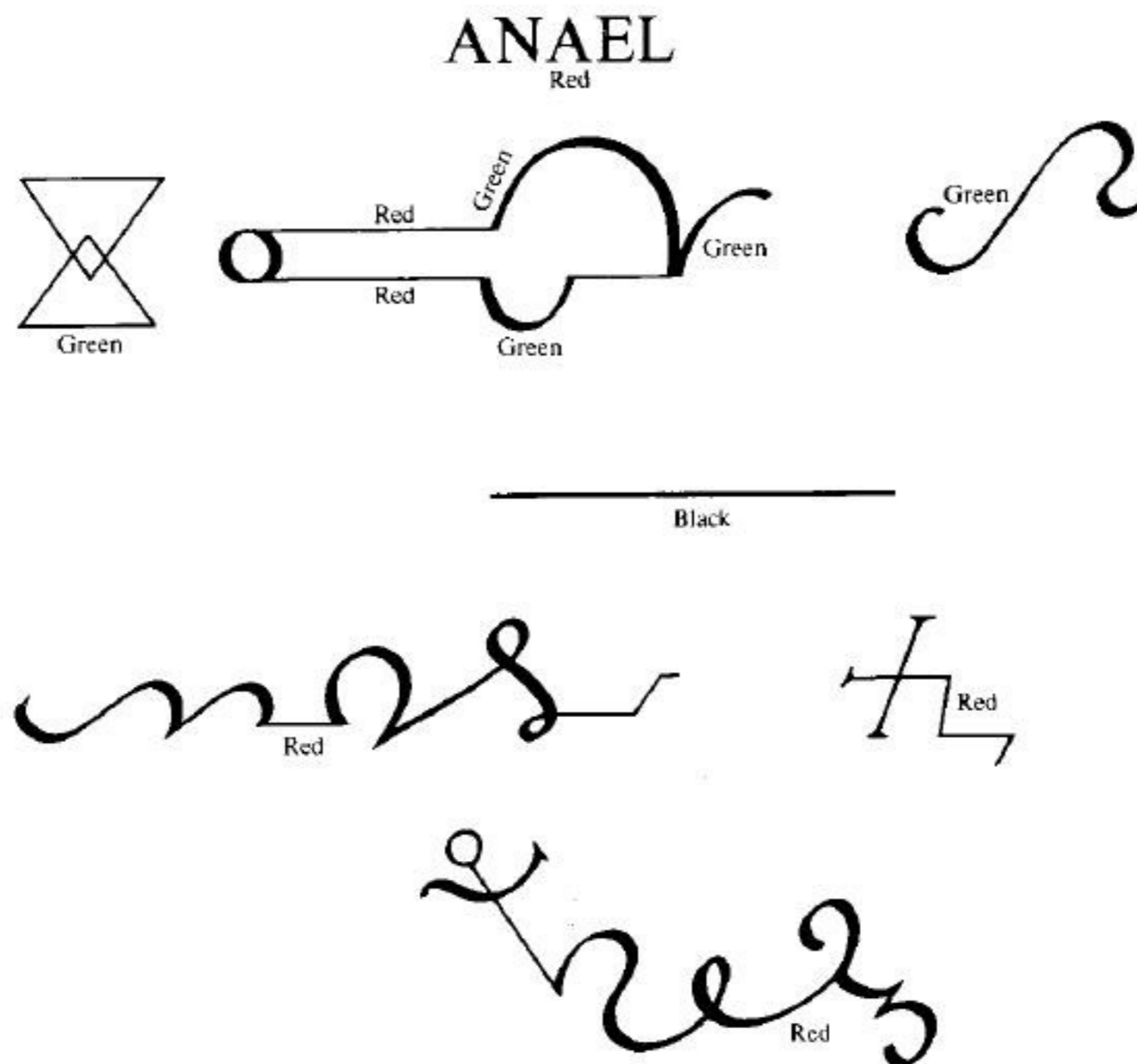

FIGURE 22

In this Sigil there be taught who and what the Genii are, as also their power and virtue. There be further shown the Mysteries of the Present, Past and

Future Age. In this Sigil is hidden the Science of Merchants. Also here be those things which do appear and are reputed to be supernatural. Also herein we can obtain the revelation of unknown things, but this (is only granted) unto the Elect of God.¹

Also the Praxis of those Arcane Secrets of the Lord is declared and demonstrated in this Sigil, wherefore Adore the Lord thy God with thy whole heart, and love thy neighbour. In the Praxis or working of this Sigil thou shalt constate that the effects hereof be certain and true yet (causing) the greatest wonder and astonishment.



¹ This whole paragraph is in most vile Latin, and is difficult of purely literal translation.

THE SACRO-MYSTIC THEOLOGY OF OUR FATHERS¹



CONCERNING THE SCIENCE OF THE REGENERATION OF ADAM AND HIS CHILDREN BY PELECH²

We have given and told unto you many things regarding the Good Spirits who can serve you faithfully. Those we are here about to speak of can also do the same, seeing that they served our First Parents from the Creation of the World.

OPHIEL is a Spirit of Piety. He will teach you all the Wisdom of our First Father. Thus is his Character (see Figure 23).

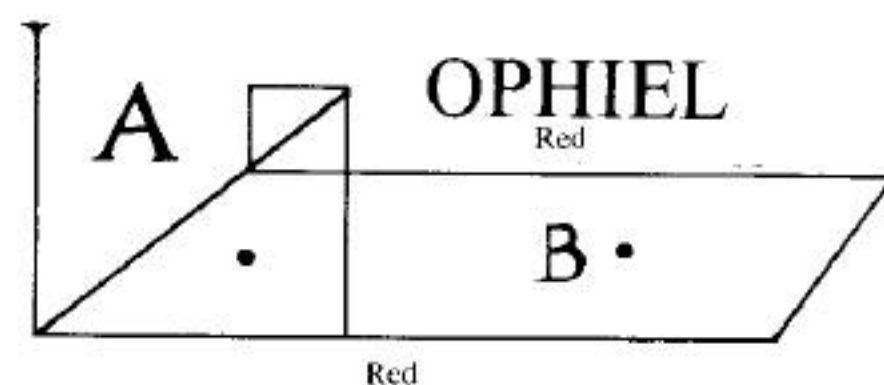

Characters of the Spirit which be under the
domination of OPHIEL

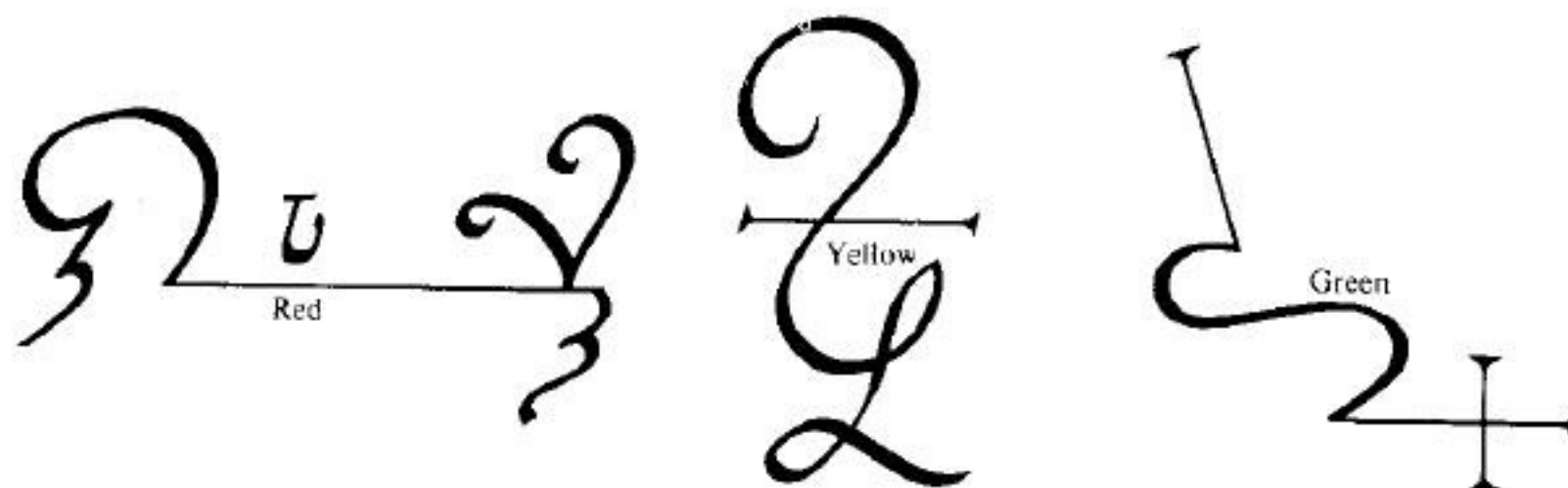

FIGURE 23

¹ Here the title changes.

² Here follow three characters which are evidently intended for the Hebrew letters P L Ch, Pelech.

In this Sigil there be taught the Mysteries of the Regeneration of Adam and his Children in Time, through Pelech³ now shown forth visibly as Jesus. Also the forms of those in torment.



CONCERNING THE DEVILS AND HOW THEY MAY BE BOUND AND COMPELLED TO VISIBLE APPEARANCE

Now this is the Object of the Diabolic Qabalah.

(ASMODEUS. LEVIATHAN) These Spirits teach you further the Malice of the Devils. Avail not yourself of the services of these Evil Spirits who are deceivers. It is alone the Name of God which can enable you to force them and all others to come unto you. Thus are their Characters (see Figures 24 and 25).

³ Later in the Work 'Pelech' is used as the Name of Jesus.

ASMODÉ

Green

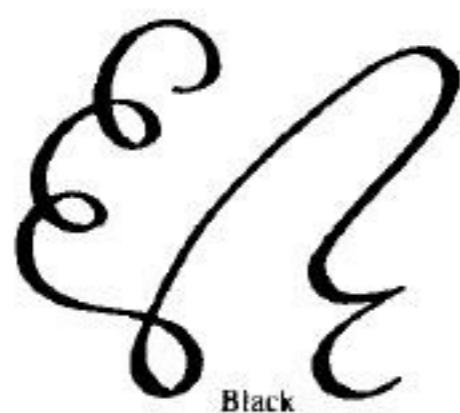

Black

LEVIATAN

Green

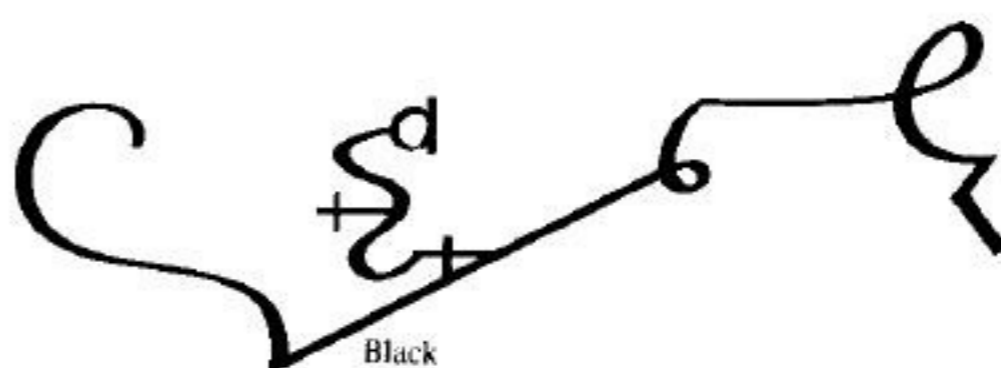

Black

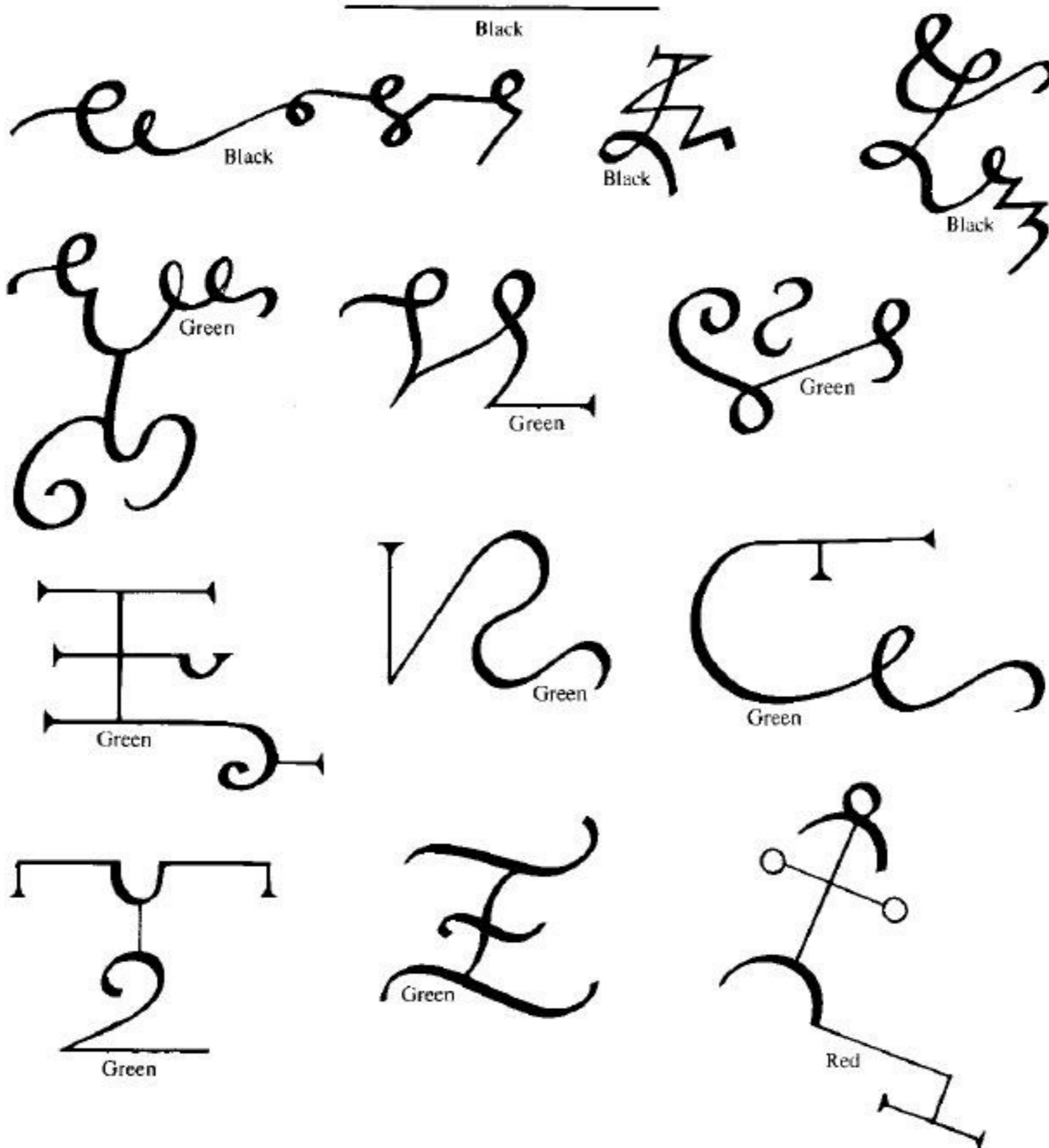

FIGURE 24

FIGURE 25

In this Sigil be the methods whereby we can force the Devils to show themselves unto us in their torments and that in bodily form.



CONCERNING THE DEVILS AND HOW THEY CAN BECOME VISIBLE

(HEMOSTOPHILÉ)¹ This Spirit again will make you see and know the Malice of the Devils, and will give you as many of them as you may wish. Avail not yourself of their services. Thus is his Character (see Figure 26).

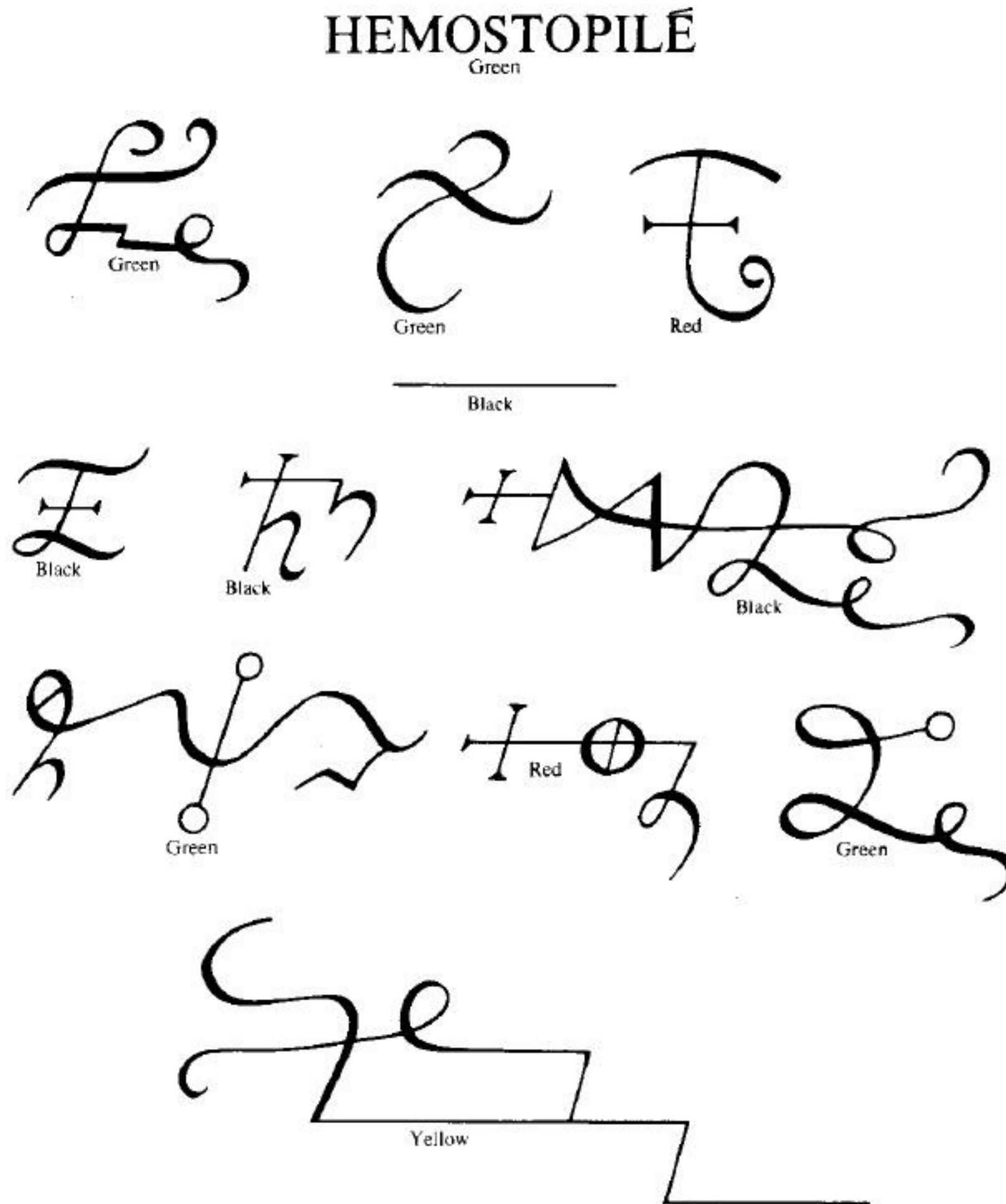

FIGURE 26

In this Sigil there be taught the methods whereby we can oblige the Devils to show themselves visibly in torments. They can deceive men and assume their forms, and change the just inclinations of men into evil passions. (Also there is

¹ Probably the same as Mephistopheles, yet the seal is different from his.

herein shown) how they can take such forms, and from what media, and what methods they make use of (to do so).



CONCERNING THE DEVILS AND HOW THEY MAY BE BOUND AND BECOME VISIBLE

(BRUFOR) This Spirit again teacheth unto you the nature and quality of the Devils, and the difference of their names and titles; how they can bind invisibly and how we can bind them. Avail not yourself of him. This is his Character. (See Figure 27).

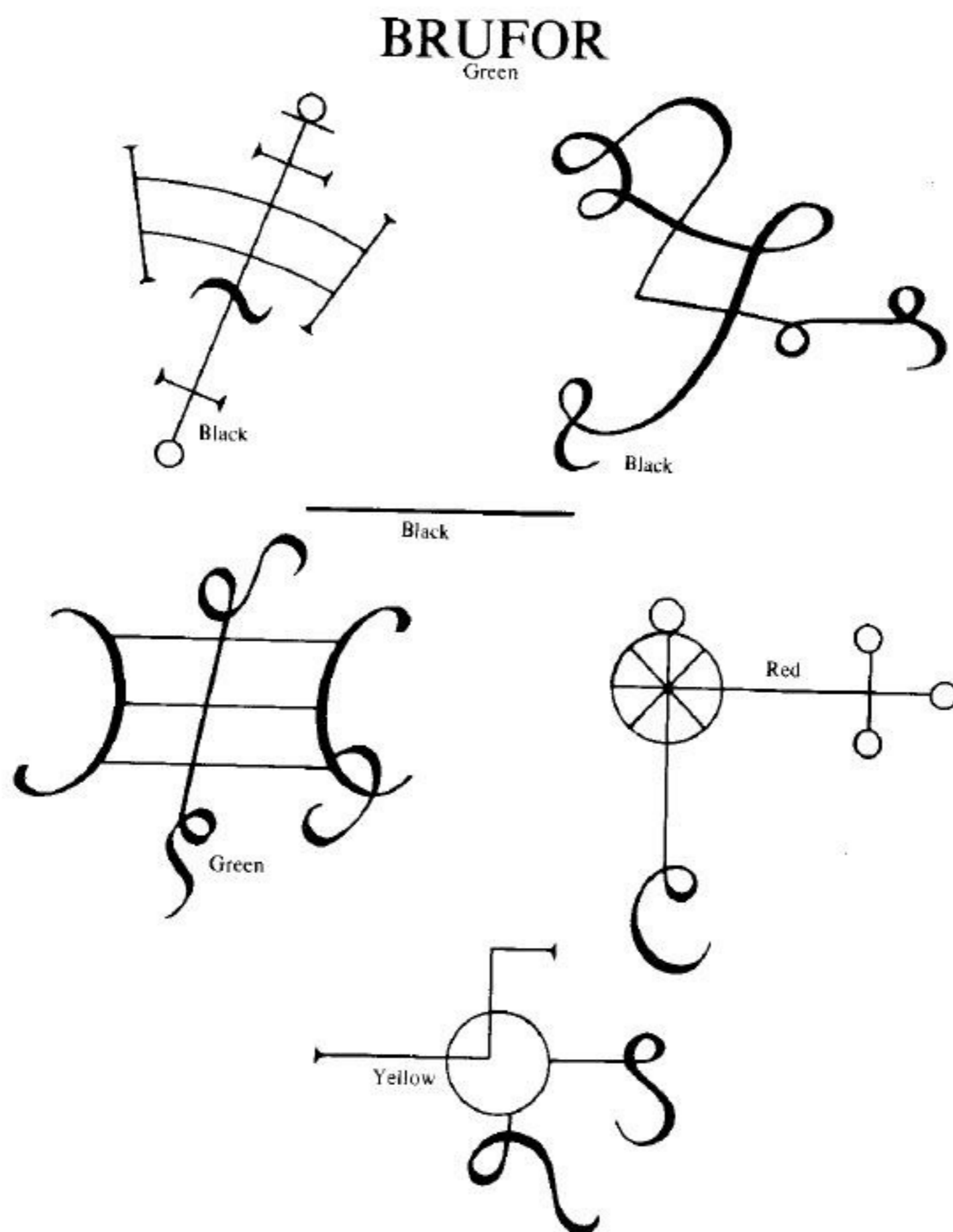

FIGURE 27

In this Sigil is taught how we can compel the Devils to show themselves visibly in the forms which they usually take to frighten and deceive (men).

There is also (here) taught how we may know them, for the Devils are known by their Names. Also whether and how from their Names their actions and operations can be known. Also how by the light hereof we can find out the means of driving them away from us and from our works and operations.



CONCERNING THE WAYS OF KNOWING THE DEVILS AND OF BANISHING THEM

(LAUNÉ) This Spirit again giveth unto you the knowledge of the Devils, but I counsel you not to avail yourself of his services, for he is a very wicked Spirit and a deceiver, who will do all in his power to entrap you, and afterwards he will mock you. Thus is his Character (see Figure 28).

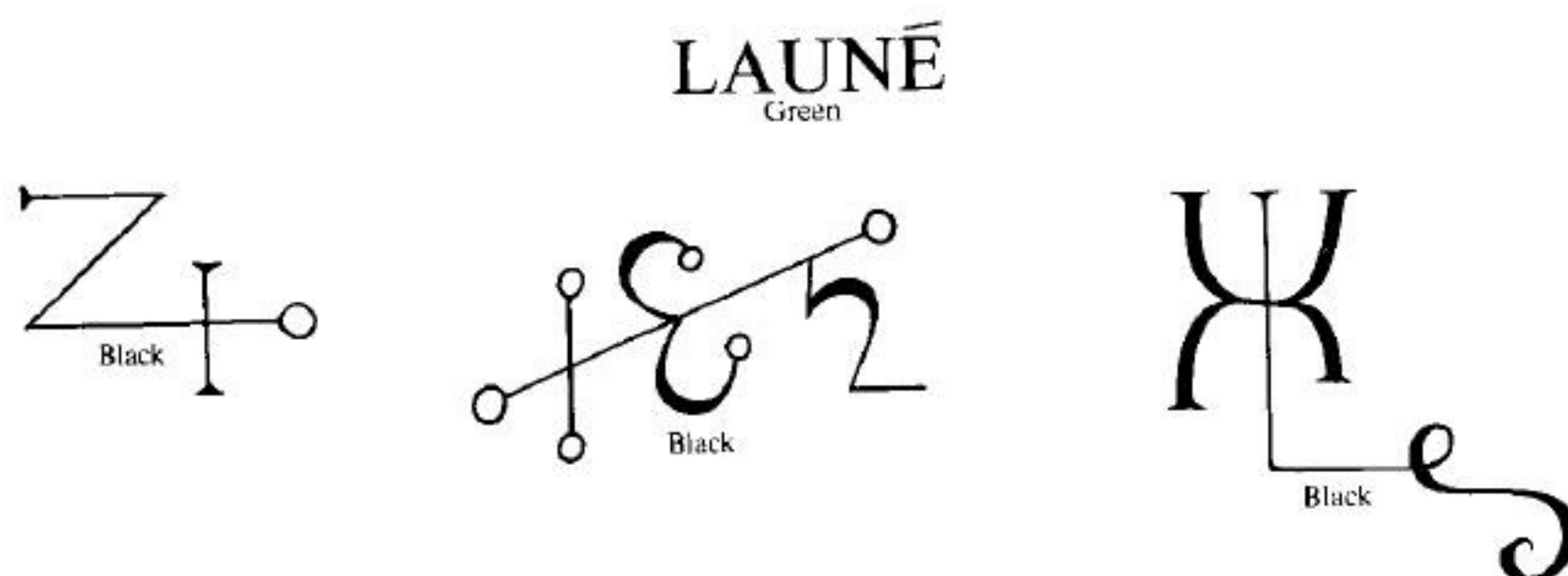
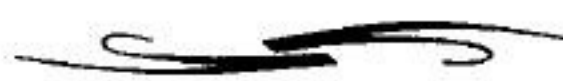

FIGURE 28

In this Sigil there is taught whether they can have proper Names as distinct from the Angelic Names, seeing that they were transformed through their casting out: whether they can lead their lives in any definite place, or wherein there is a place determined; whether it be permitted in the Spheres or in the compounded Elements. Also there is herein taught whether they have free will; in what way they conduct themselves in the places which they occupy; Also whether where they live be determined by the Power of their Expulsion.

Whether again there was an interval between their Expulsion and the Creation of Adam, and (if so) what interval. Herein also are taught unheard of and most terrible Mysteries, of such Interval and of Life.



CONCERNING THE DEVILS AND THEIR LIFE

(BETOR)¹ This Spirit maketh you comprehend who and what the Devils or Angels of Darkness really are; the difference of their Names; their Powers; and what they can do. He, being invoked, appeareth speedily, and that at any time and at any hour. Thus is his Character (see Figure 29).

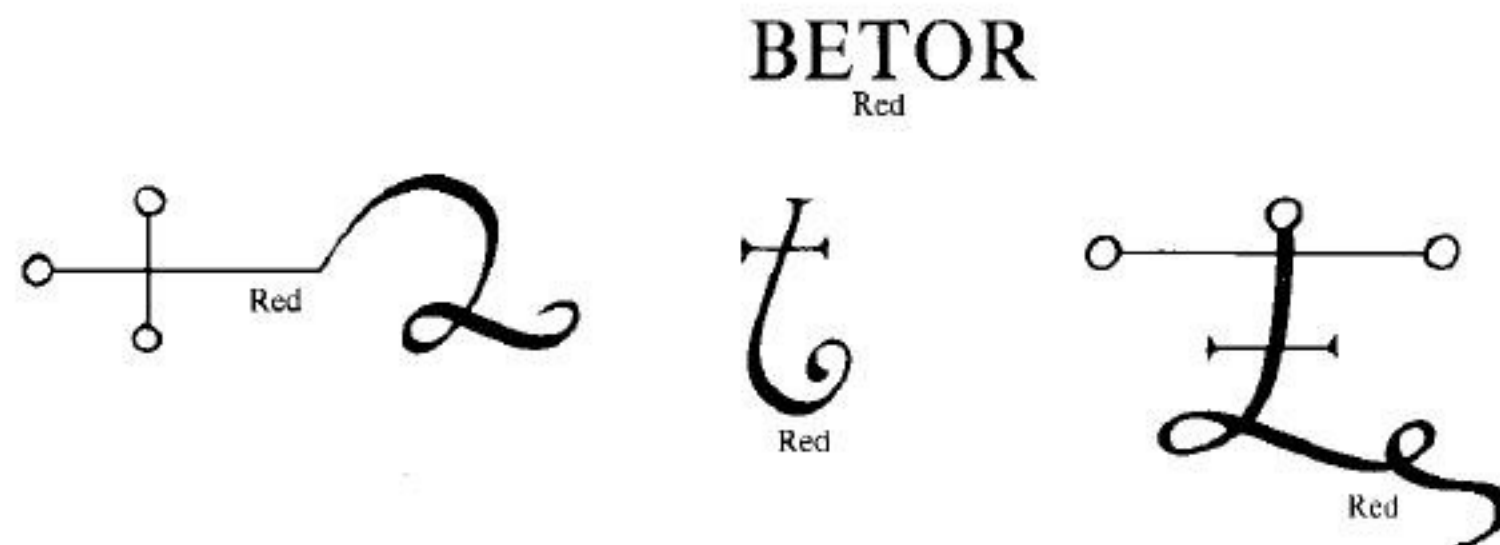
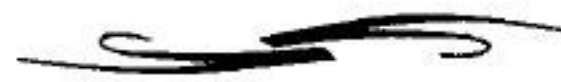

FIGURE 29

In this Sigil there be taught what are the Devils or Angels of Darkness; how they can be known and understood by their proper Names; and how they are to be distinguished from the Angels. Also whether the Devils can fully be known by proper Names; and whether the Virtue of God is impressed upon them, or followeth hereupon.

There is also herein taught how we can attract such Angels unto us as Familiar Spirits by the knowledge of their Names.

Also the Mysterious Operations of such Angels, both as regardeth ourselves and our actions.*



¹ This is usually considered as the Name of the Olympic Spirits of the Planet Jupiter, which is a Spirit of a good and benevolent nature.

* *Additional Note* In fact several of the names of Spirits given in the *Armadel* seem to be variations on the names of the so-called 'Olympic Planetary Spirits' who feature in almost all the Faustian grimoires of the seventeenth century.

CONCERNING THE WAYS OF KNOWING THE GOOD ANGELS, AND OF CONSULTING THEM

(ZADKIEL, SACHIEL) These Spirits do give you in all things whatsoever advice may be good and fitting; they discover unto you all kinds of treasures, give them unto you and carry them whithersoever you request. They can also give you a Purse wherein is Gold and Silver. They appear unto you as soon as you invoke them, which should be on a Thursday and at Daybreak. Thus are their Characters (see Figures 30 and 31).

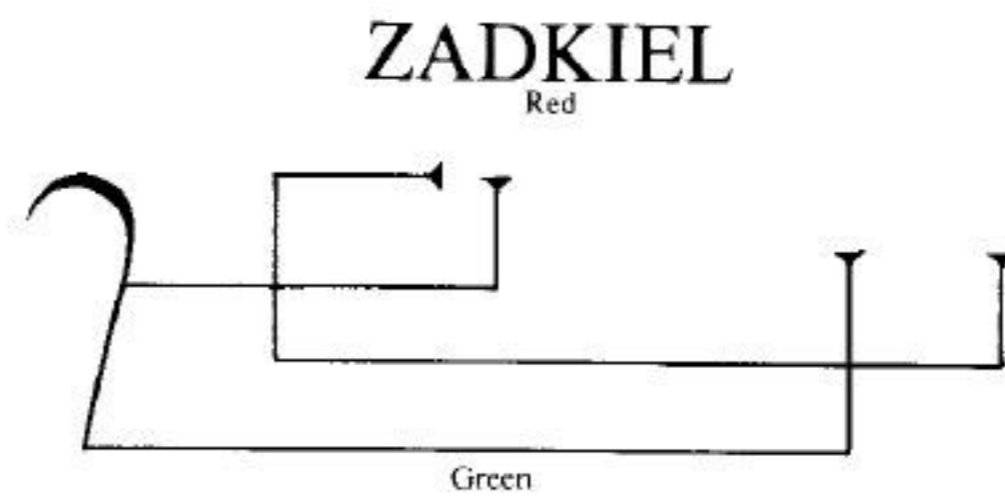

FIGURE 30

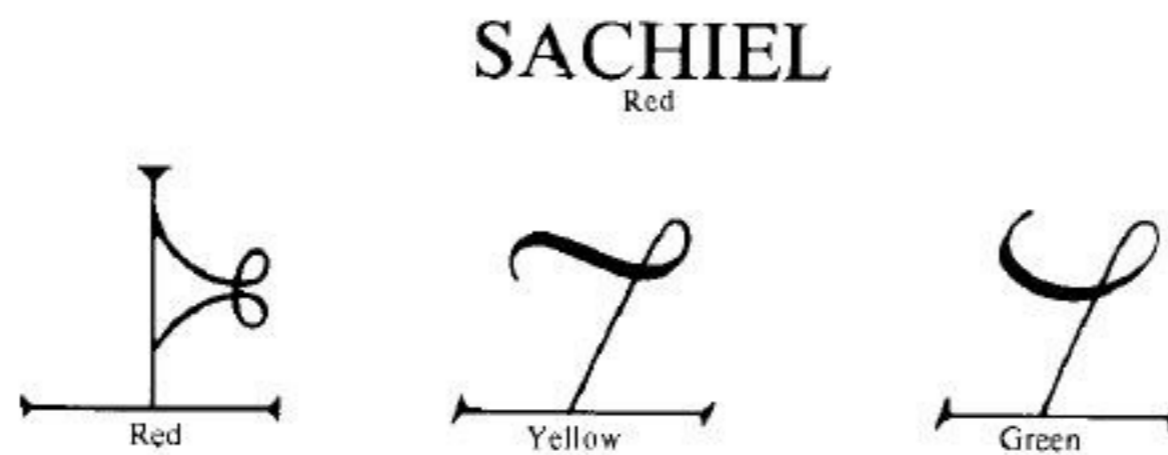
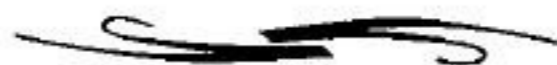

FIGURE 31

In this Sigil is taught of what description be the Angels of Light and Glory. There be also taught the Mystical Period of such a Life; and Mysteries, as they were unutterable, concerning such a Life; also that there was a certain Interval between their Creation and sending forth, and what be the Mysteries of such Interval.



CONCERNING THE LIFE OF MAN

(PHUL. GABRIEL) These Spirits, besides the Life of Souls and of Man, do teach unto you all the Sciences which you shall desire to know. Thus are his Characters (see Figures 32 and 33).

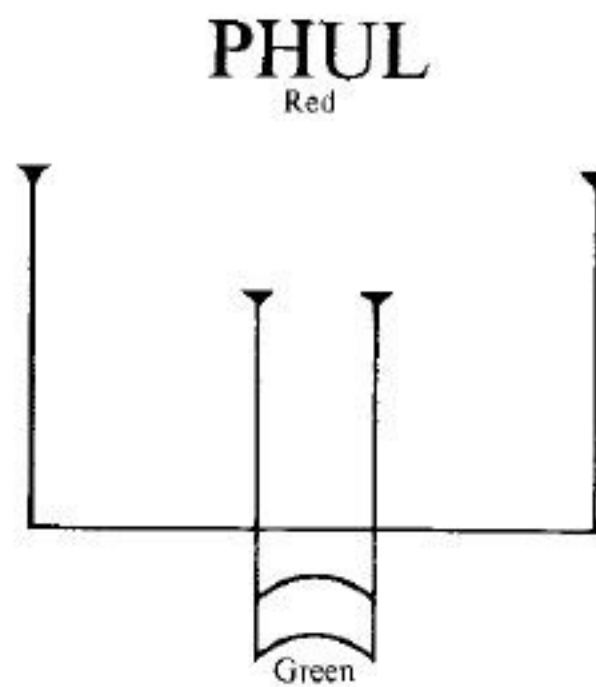

FIGURE 32

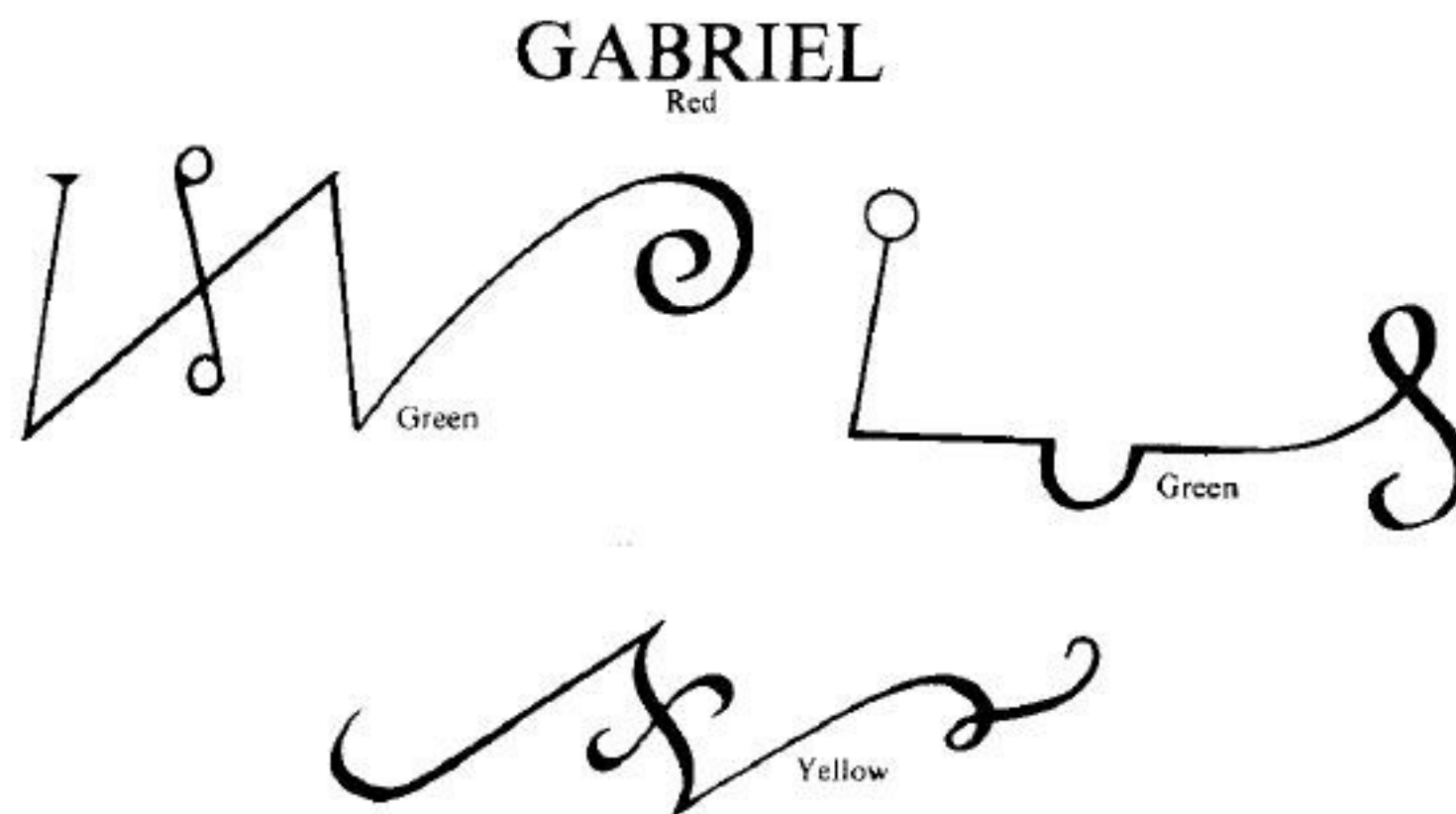

FIGURE 33

In this Sigil there is taught what may be the Life (of Man) and the Creation (of Souls) even until the time of their sending forth into Bodies.

There be also taught the great Mysteries which the Lord is willing to perform; and whether all Souls were created from such a creation alike and at one time, and so also whether such be reserved in a certain place so that going forth thence they may be sent into Bodies and rule therein for a period of time.

These Spirits are to be invoked on a Monday and at Daybreak.



CONCERNING THE CREATION OF THE SOULS OF MEN

(ARATRON) This Spirit teacheth unto you the Creation of the Souls of Men, and what they really are; as also their estate after Death. When you cause these Spirits (under Aratron) to come unto you, see that you remain not long in their company. They will also tell you by writing, that which you desire to know. This is his Character (see Figure 34).

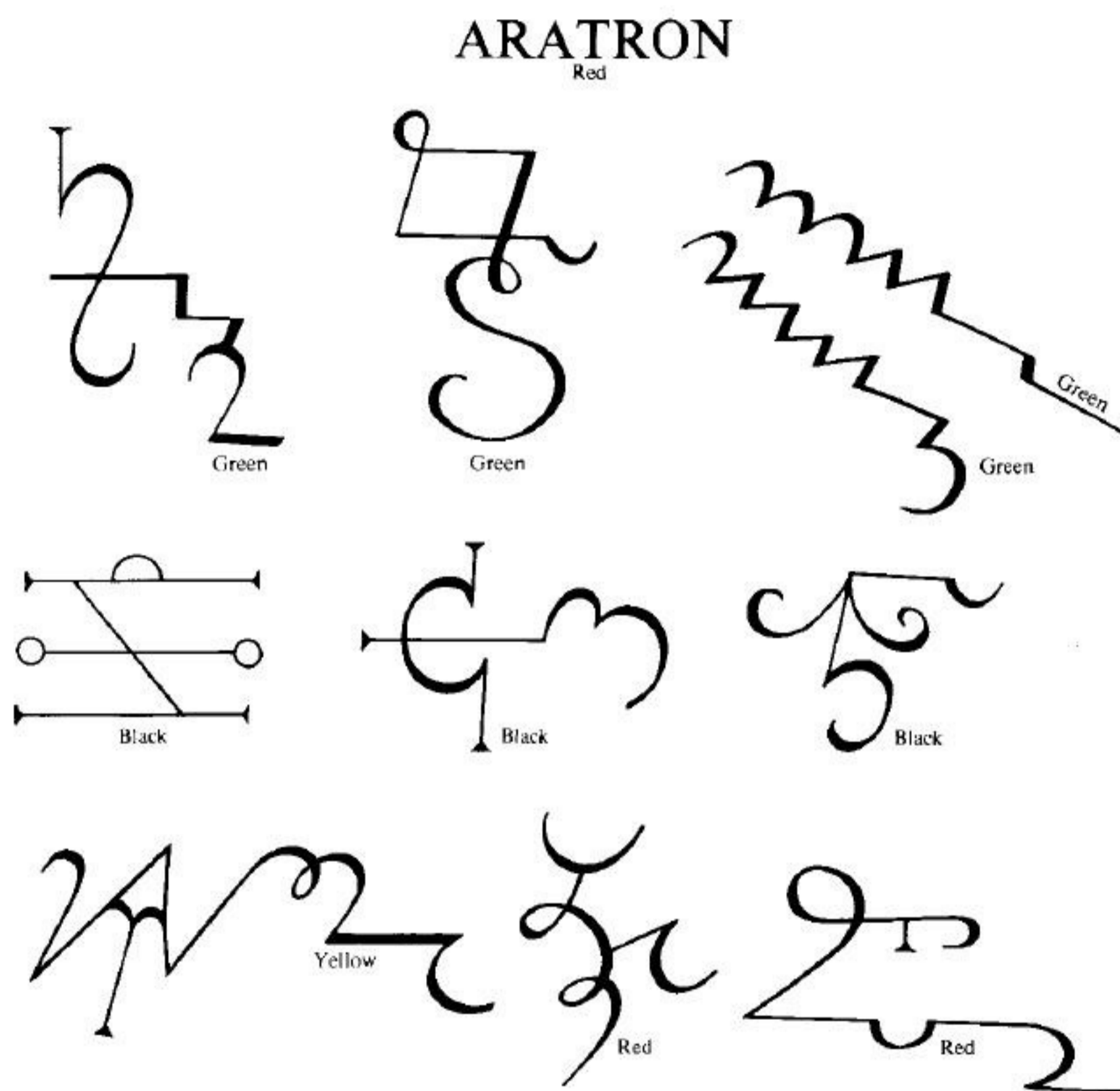
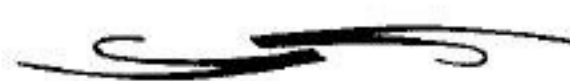

FIGURE 34

In this Sigil is taught what is the creation of the Souls of Mankind, and what is the object and end of such Creation. Also what portion of the Angelic Host did rebel; and what time they rebelled; and how the Rebellious Angels were cast out. Also by the Virtue and in the Virtue (of this Sigil) there be also taught Unrelatable Mysteries regarding that Rebellion and that Expulsion, as well as the Time of that Rebellion and Expulsion.



CONCERNING THE EVANGELIC REBELLION AND EXPULSION¹

(LUCIFER . BELZEBUT . ASTAROT) These Spirits teach you what were the Rebellion and Fall of the Evil Spirits. Thus be their Characters (see Figures 35, 36 and 37).

LUCIFER
Green

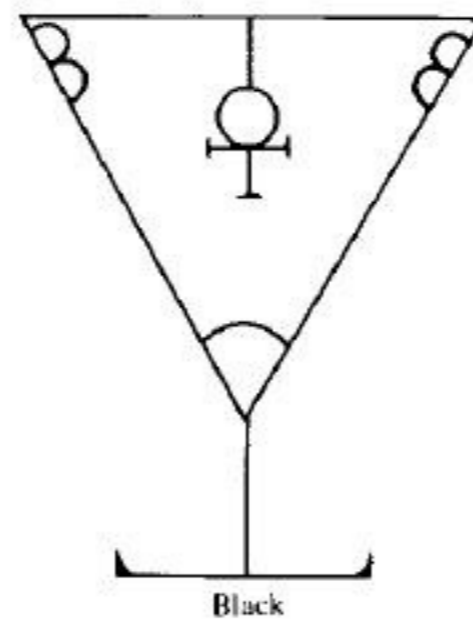

FIGURE 35

Characters of his Princes

BELZEBUT
Green

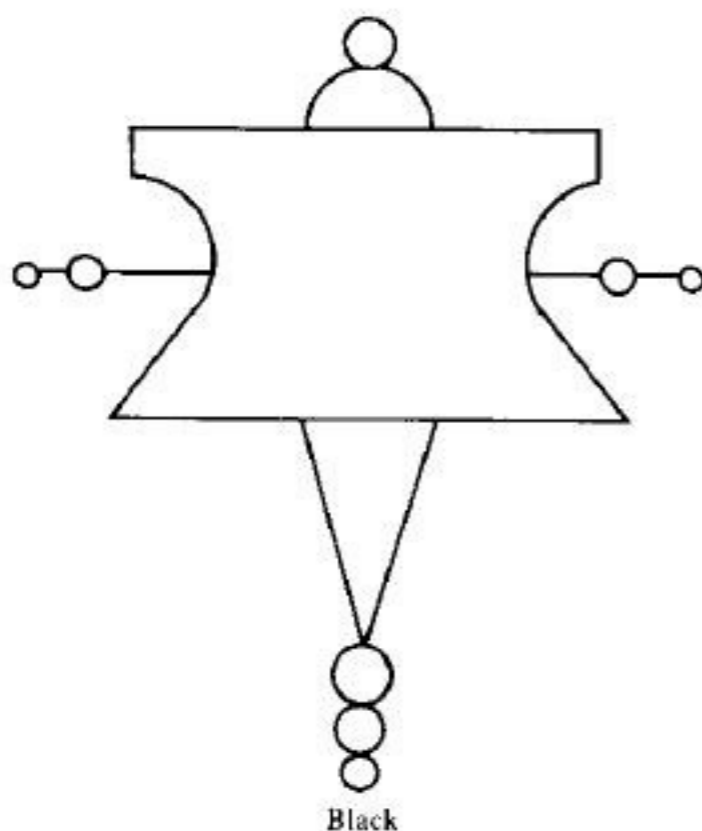

FIGURE 36

ASTAROT
Green

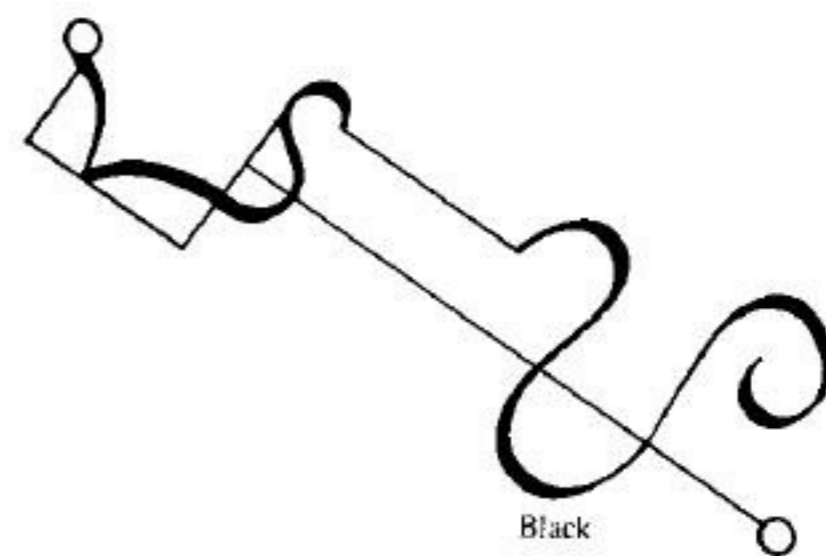

FIGURE 37

In this Sigil there be taught what was the Rebellion of the Angels and what was its cause; what were the Mysteries of their Life; whether their life should be understood as a continual action; whether the Names of these Angels were

¹ i.e., referred to in the New Testament.

given unto them through the commands of God; what things have been committed unto them, whence and of what kind; and whether a certain Angel be allotted unto any or unto some especial commands. There be taught also herein certain most hidden Mysteries, alike admirable and not admirable, concerning their Life, which same be revealed unto very few, (especially the comprehension of their Mode of Life before the Fall).



CONCERNING THE LIFE OF THE ANGELS BEFORE THE FALL

(ZAPHKIEL and his Spirits) These do (not) teach you of what nature is the Life of all Angels, and their business and intercourse. Thus be their Characters (see Figure 38).

ZAPHKIEL Red

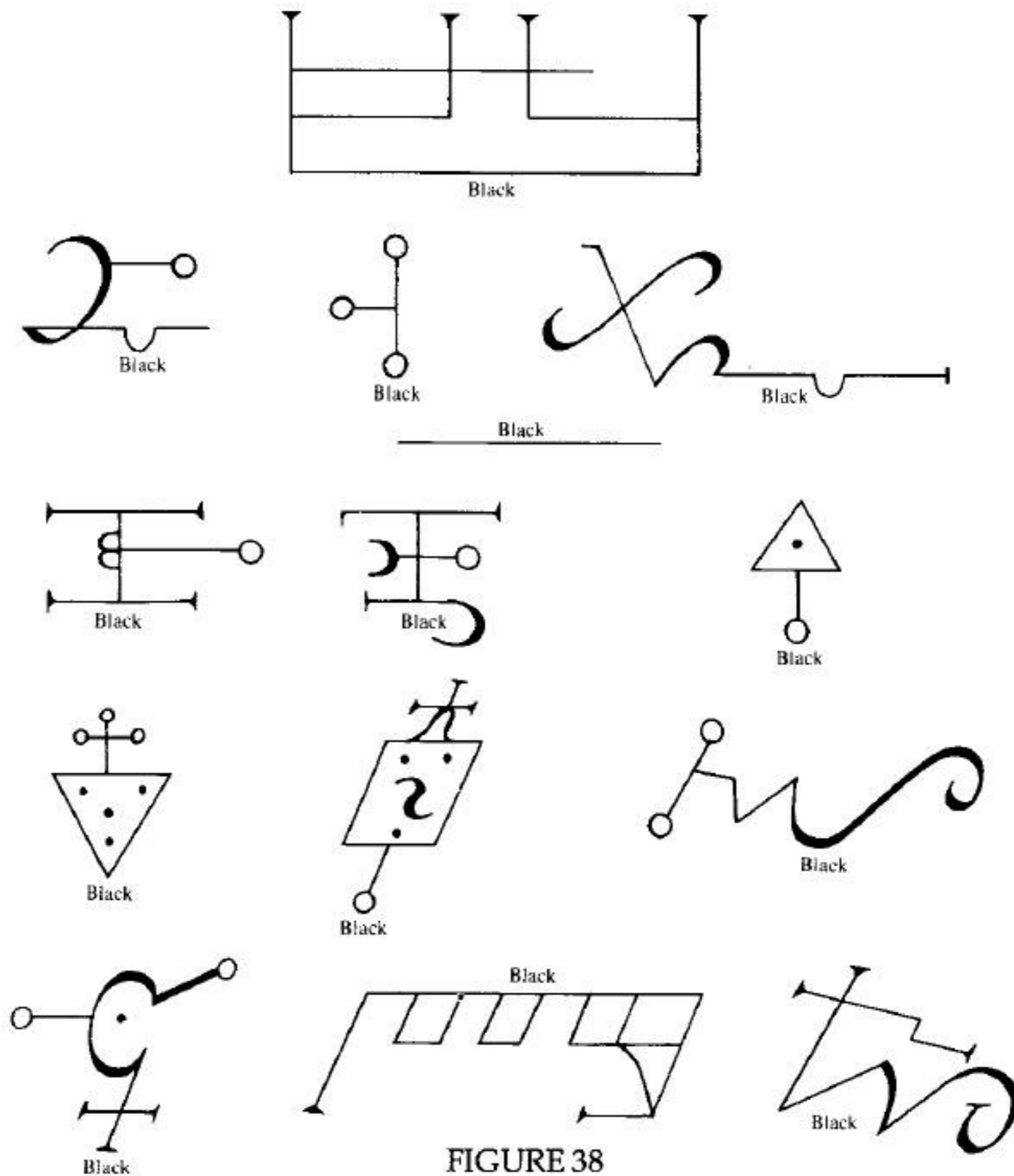

FIGURE 38

In this Sigil there is taught what was the Life of the Angels before the Fall. There be taught also the Mysteries of their habitation; whether there be a place of habitation for the Rebellious Angels; whether there may be found a Place Impassable and Void; whether the Angels were without any affection of passion soever; whether they were created in happiness; and whether such is confirmed unto them.



CONCERNING THE CREATION OF ALL THE ANGELS

(OCH and his Spirits) These do teach you what is the Nature of the Angels. These subjects fall under the domination of Och who is a Solar Spirit, and should be invoked on a Sunday at Daybreak. Thus are the Characters (see Figure 39).

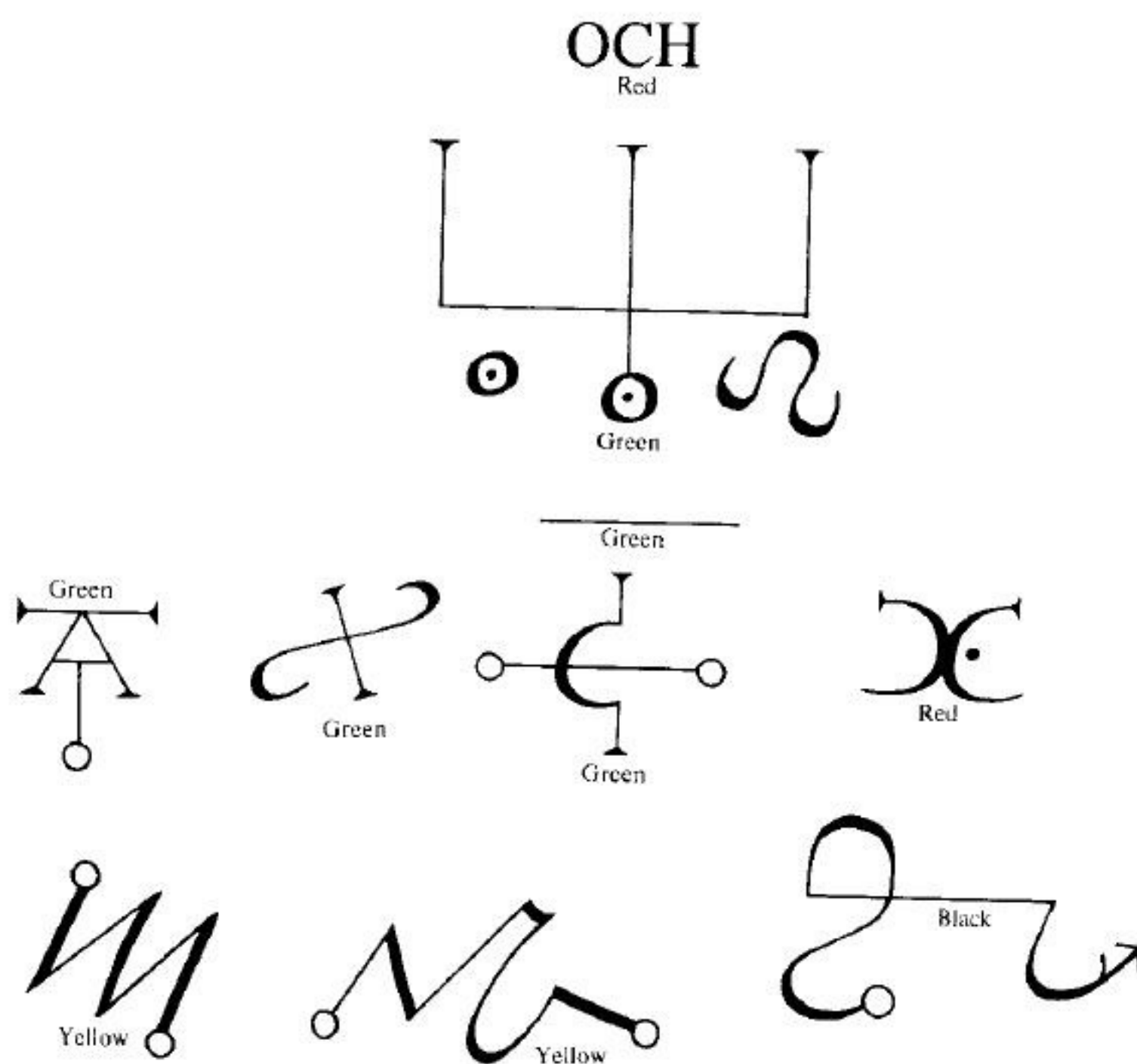

FIGURE 39

In this Sigil there is taught what is the Nature of Angels; what may be the object and end of such Creation and whether it be established to operate in the preservation and destruction of all Creatures. There is also taught Who and What is that Promised Messiah; what is the Kingdom; What is the Kingdom of

Israel; what the Restitution through¹ Him for the Wretched; what kind of a Prophet He may be; and what things can be performed by the Messiah for the welfare, restitution and liberation of His people in Daya (sic).

In this Sigil as in others (Magical ones), there be Mysteries through the combination of Geometry, Gilgud² and Numbers, as well as points relating to Geometrical (Symbolism).



CONCERNING GOD, THE PRESERVER, THE DESTROYER, AND THE CREATOR

(GABRIEL and his Spirits) These Spirits do teach you all kinds of Mysteries. Thus is the Character (see Figure 40).

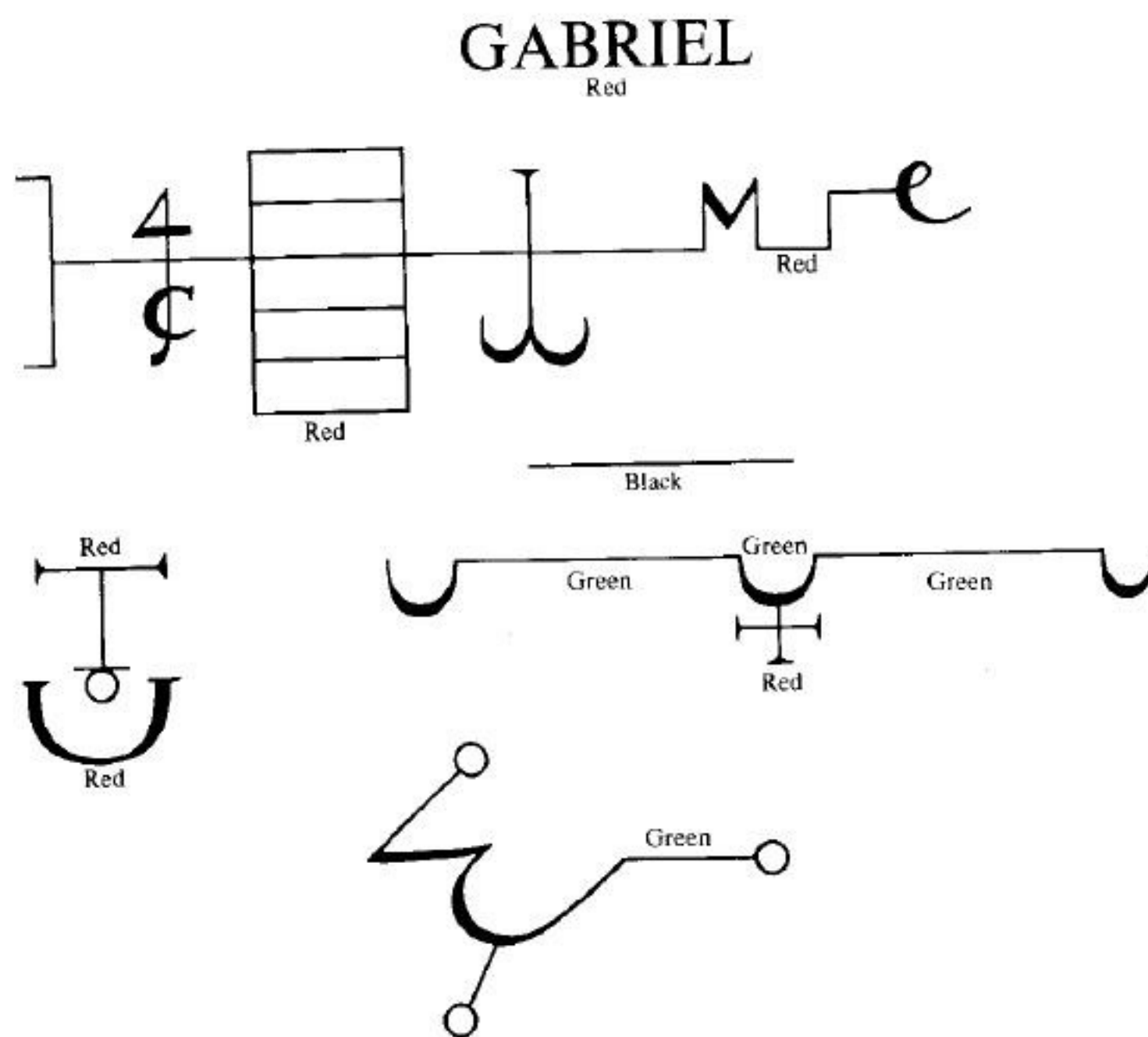

FIGURE 40

In this Sigil is taught what Mysteries the Lord God is willing to permit to operate in Creation, through the uncontaminate Inner Knowledge whereof also

¹ At this point in the original MS. a leaf is interpolated bearing only the Hebrew words transliterated as: IHVH El Adonai Elohim Shaddai Agla Elohi.

² 'Gilgud', from the Hebrew, means Wheel or Revolution and is often applied to Permutation of Names by Substitution, transposition, etc. of the Letters composing them.

(Abraham) did rule and govern himself and went forth by the command of the Lord God to travel in the Land of Chanaan, wherein also he sojourned and was buried by his two (sons) in a Mystical Sepulchre, that is to say in the Cave near unto Cariatarbee, wherein also Abraham, Isaac and Jacob were interred. Now this same Cariatarbee is Hebrew Mambre, and Ephrata.

In this land did Abraham behold Three and Adore One, and thus was it counted unto him for righteousness.

In this Sigil is taught Who be those Three Persons meet to be adored, and how they do harmonise together; also as concerneth the Angels and Men what Mysteries they do operate; also how they do harmoniously act through Created Beings, Angels and men. All these things be shown forth in the Letters and in the Sigil herewith given, through their Number and Combination.



CONCERNING GOD IN HIS TRINE PERSONALITY

(MICHAEL and his Spirits) These be the Characters of the Spirits who do teach unto you all Mystical Sciences (see Figure 41).

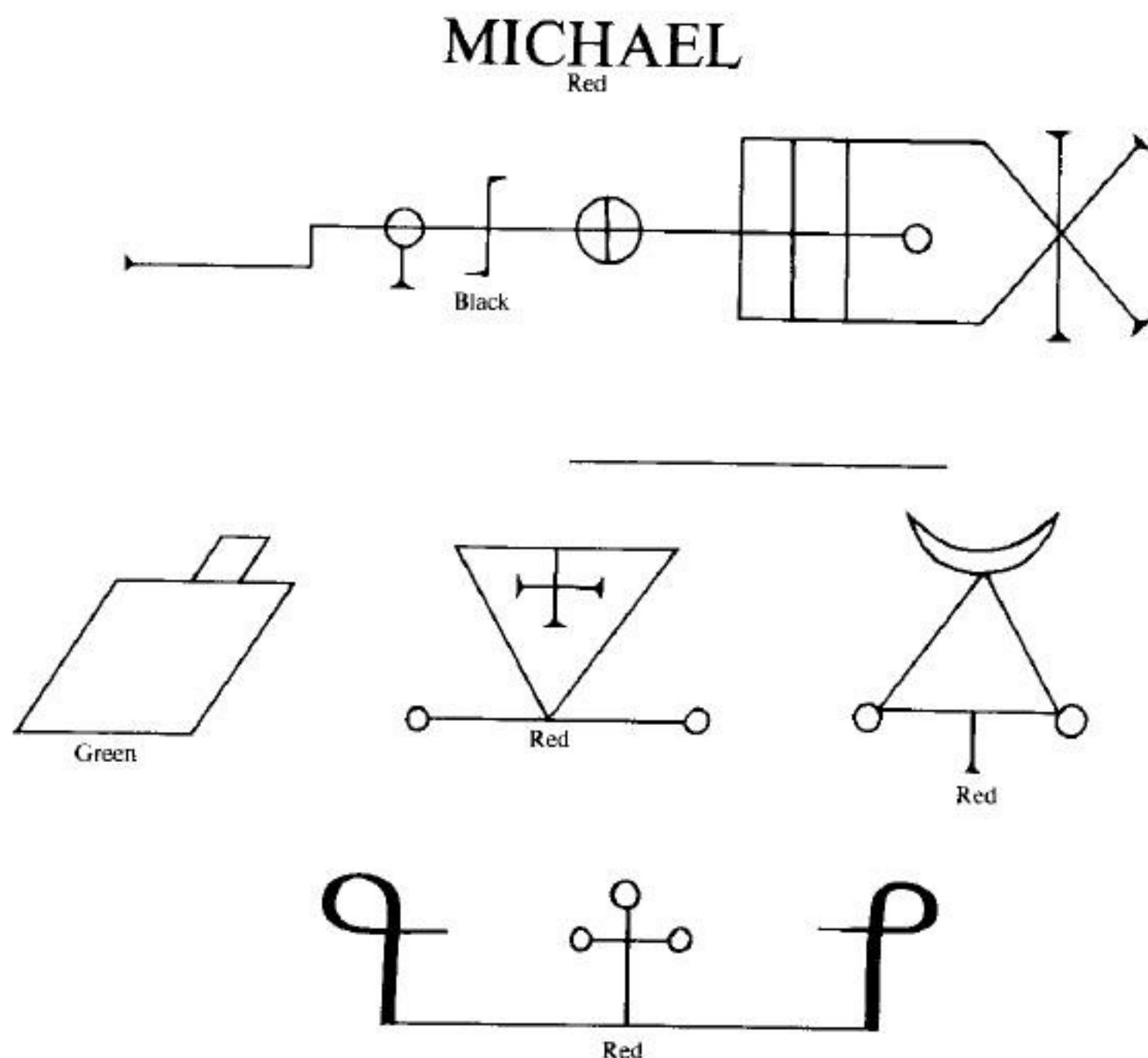

FIGURE 41

In this Sigil be taught the Mysteries of the Trinity Whom Abraham our Father knew, believed in and confessed. There is also taught herein how It is pleasing and harmonious in Itself, and by what ways It may be propitiated, as hath been communicable through Its Adorable Attributes. There is also (herein) taught how the whole may be communicable unto and in Thee, and as regardeth Thee in a profound and wonderful manner, through the Combinations of the Letters which be in the Great Central Triangle, between the Small Orb and Triangle. There is also (herein) taught how the Science of God may be communicable through His Attributes unto all Created Beings; and especially those most profound Mysteries which He operateth with regard both to Angels and Men, the which be shown through the combinations of the Letters which be without the Small Orb.

Also in all this Science thou shalt observe the Combinations of the Letters, of Geometry, and Gilgud or of their Numbers, in thy searching examination of all Sigils.



CONCERNING GOD THE UNIVERSALLY ONE

These be the Characters of the Spirits who do teach unto you all kinds of Sciences (see Figure 42). They be under the domination of CASSIEL, and are to be invoked on a Saturday at eleven o'clock at night,

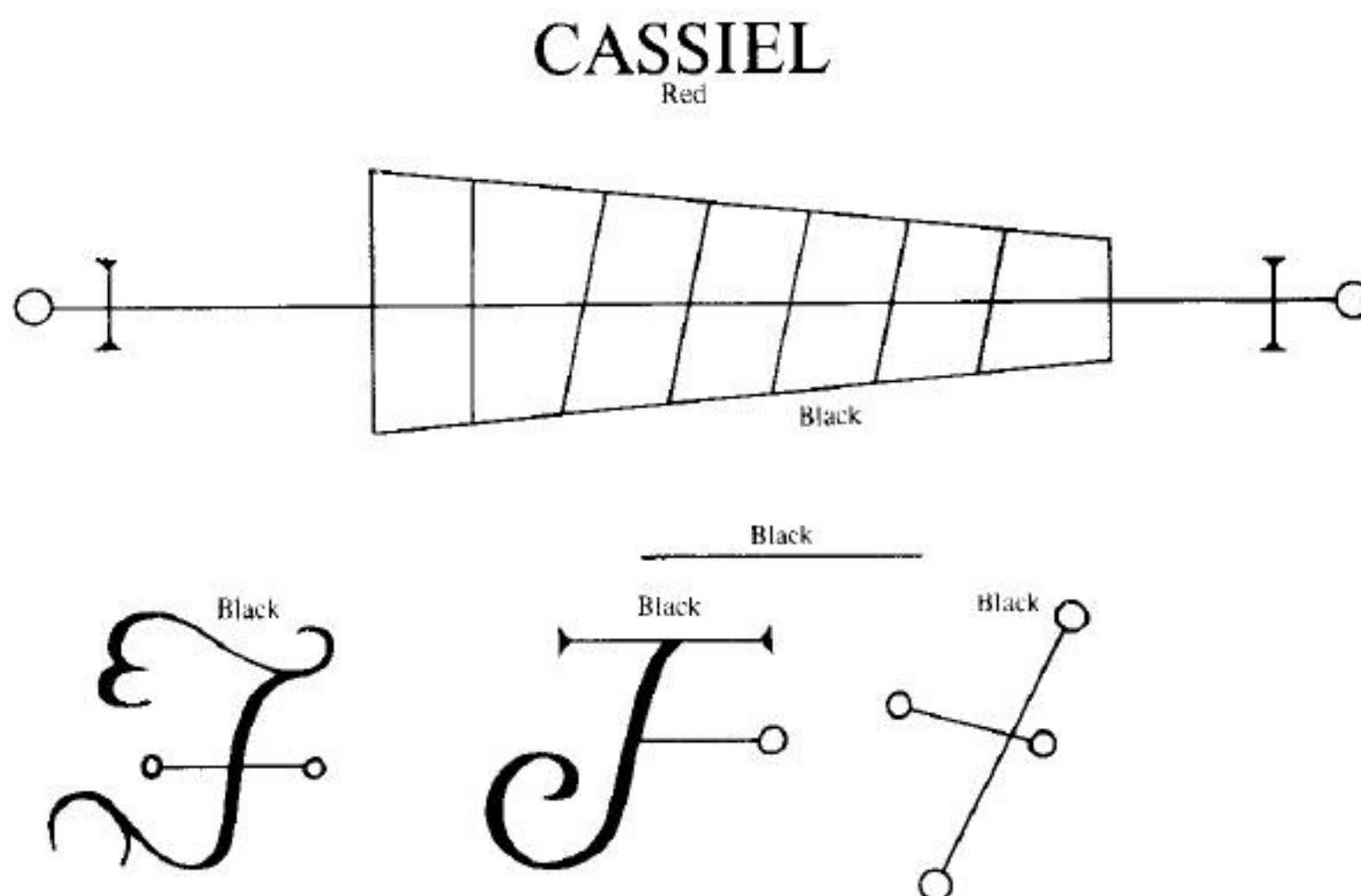

FIGURE 42

In this Sigil is manifested the most glorious Science of God.

In this are taught the Paths of Wisdom¹ and their profoundest Mysteries; how we can know such paths; and how we may become worthy to walk therein. There be also shown the Mysteries of our hearts through this Number of Thirty-two. Its significations teach the Mysteries of the Regeneration of our Heart; whether from the beginning it was constituted to operate hereby and herewith, and by the Word of God; whether it was distinct in the Mind of God; and what be its place, Science and dubitation, its hope, faith and ultimate desire.

If you shalt desire to know thoroughly these Paths of Perfect and Profound Wisdom together with their Mysteries; remember the combinations of writings in the Sigil (He)² which is in the centre of the figure of the Heart.

Whosoever thou mayest be, despise not this wonderful Science and Geometrical Searching Out, and the points of E o n,³ and the Mystical Numbers of the Letters. Also the Lord said unto God:⁴ 'Go forth through the midst of the City, through the midst of Jerusalem, and sign a Symbol upon the foreheads of the men who groan and grieve over all the abominations which be in the midst thereof.' Also he said unto them: 'Hear me, go ye forth through the City following after him, and smite ye every man upon whom ye shall see 'T h a u n e'.⁵ Ye shall slay them from my Sanctuary. — Begin.'

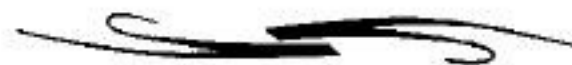

¹ i.e., the thirty-two Paths of the *Sepher Yetzirah*.

² This is evidently the Hebrew letter Hé though it looks more like the numbers 33 in the MS.

³ The Gnostic term for emanation of the Deity.

⁴ Cf. Ezekiel.

⁵ The Greek Letter Tau(?).

CONCERNING THE PATHS OF WISDOM

These be the Characters of the Spirits of Force and Counsel (see Figure 43).

Characters of the Spirit of Force and Counsel

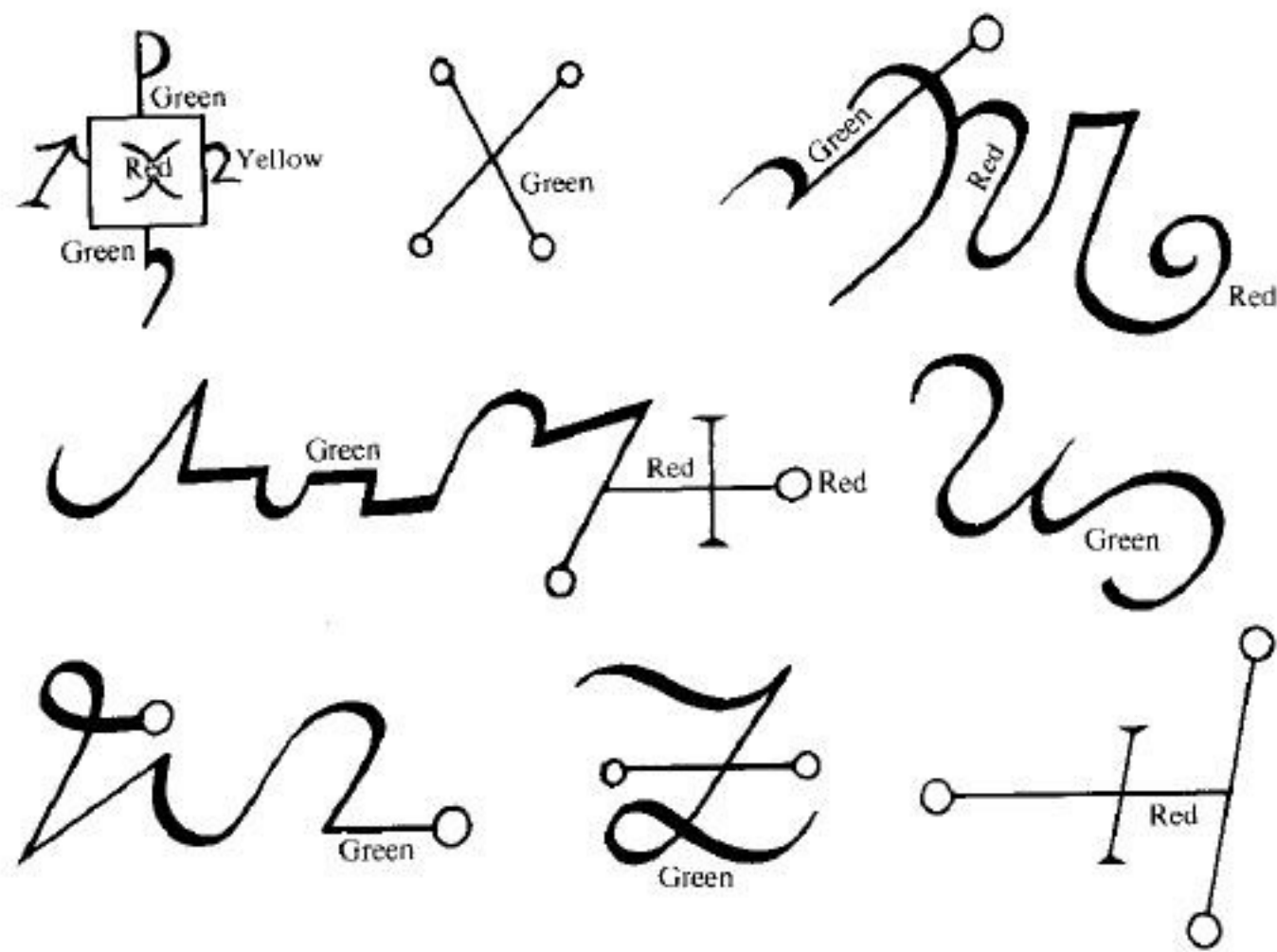

FIGURE 43

This is the Sigil of Joy, and of the Spirit which goeth forth and retireth. The Characters of the Spirits of Joy (see Figure 44).

Characters of the Spirits of Joy

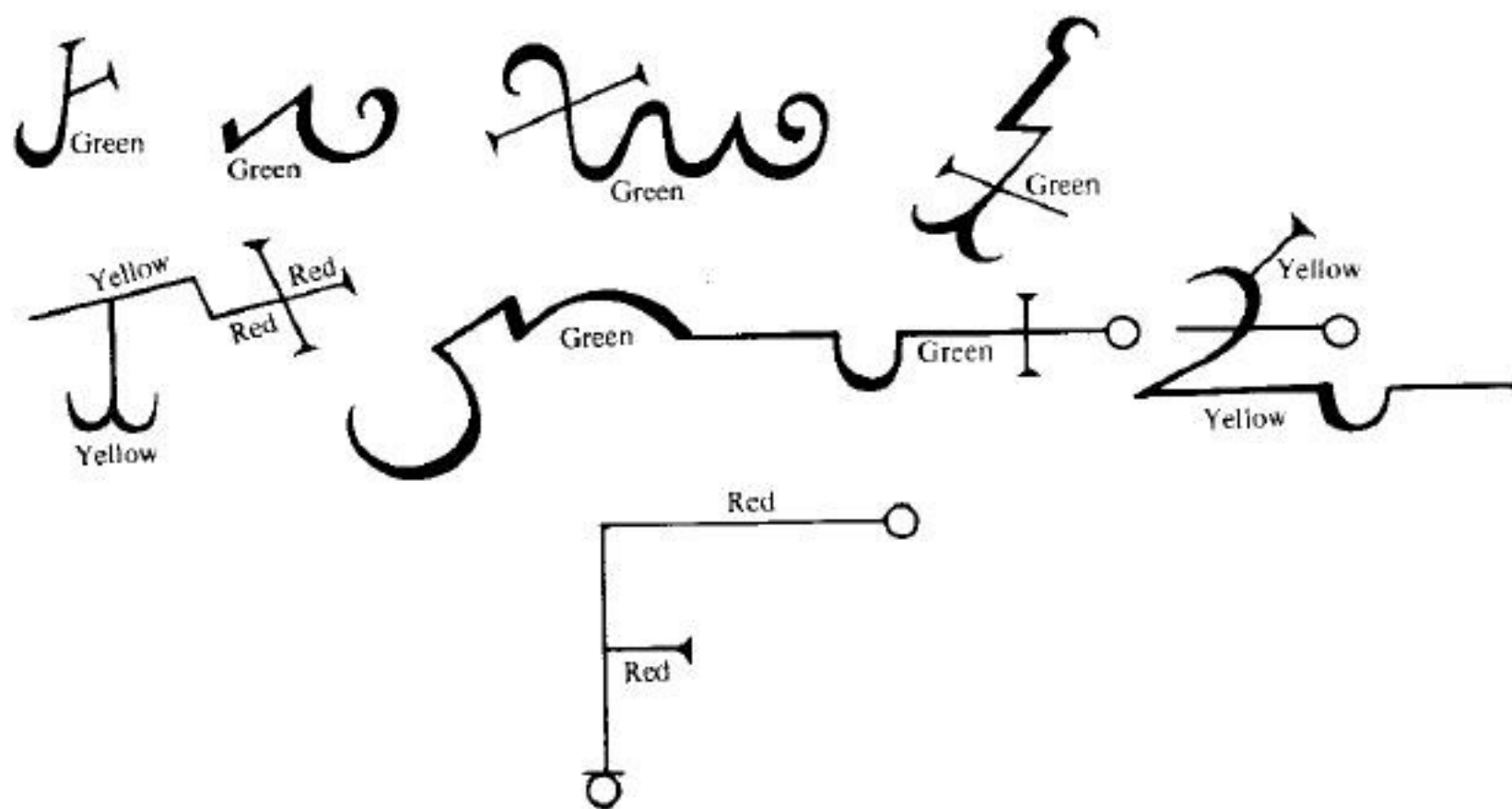

FIGURE 44

Thou¹ shalt have fasted with the Lord God Pelech, now (called) Jesus, for Seven Days, the which shall be passed in humility and sobriety, in mercy and patience, in peace and equilibrium; (that is to say) in the beginning of all the Sigils of Love and Charity, and from which they do proceed.

The Characters of the Angels of Love and Charity (see Figure 45).

Characters of the Angels of Love and Charity

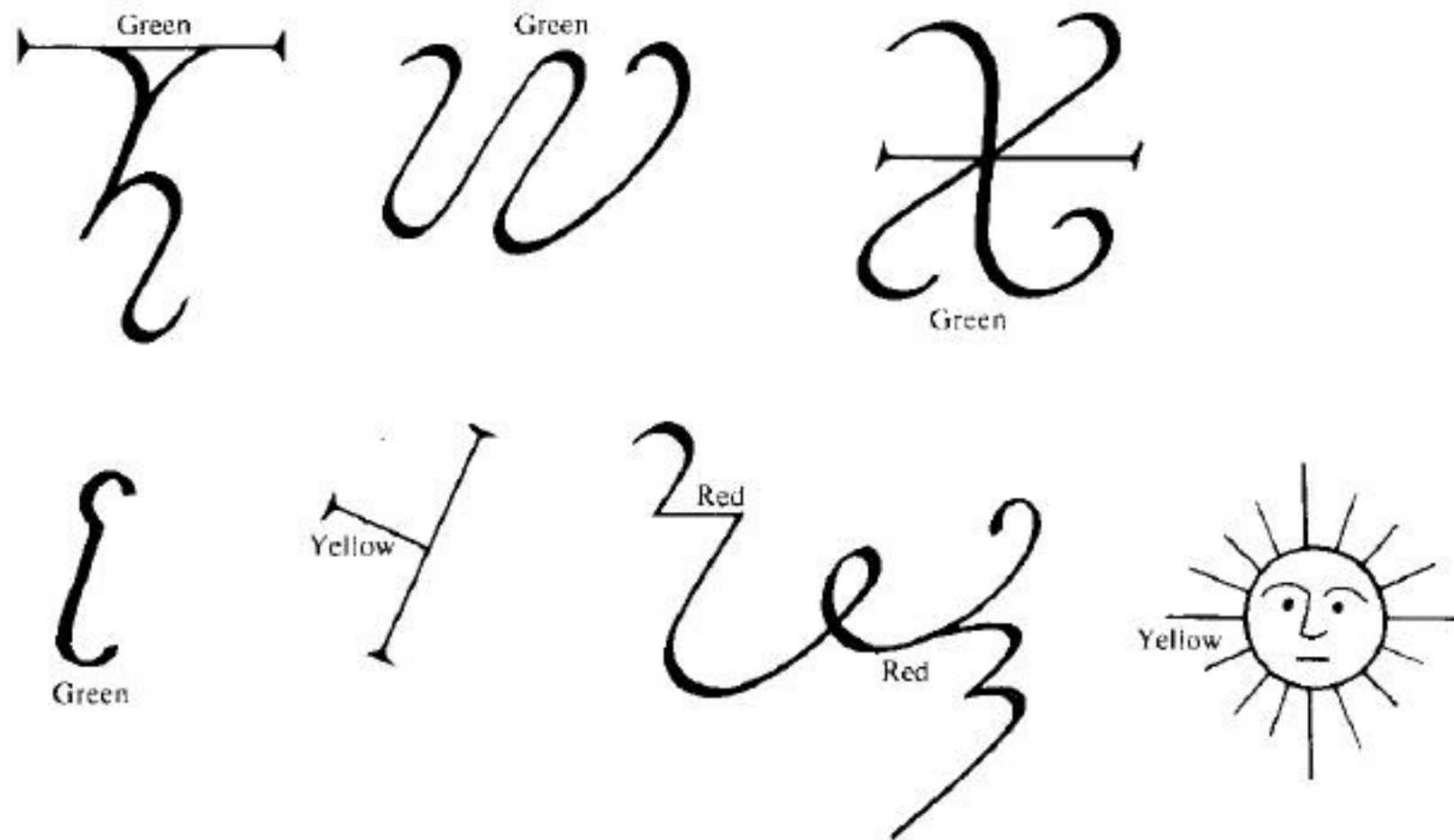

FIGURE 45

Is it not written and reported by tradition that 'there were Six Men² who came from the way of the Upper Gate which looketh toward the North, each holding in his hand a weapon of death. Also in the midst of them was one Man clothed with a robe of fine linen, and he had instruments for writing hung at his side. And when they had entered, they stood beside the Altar of Brass, And the Glory of the Lord of Israel withdrew from the Cherub which was etc . . .' Also in the Books of Moses (it is written)³ that with 250 shekels of each of various ingredients and with 500 shekels of Myrrh, etc., according to the weight of the Sanctuary, and with a certain measure of Olive Oil, thou shalt make a certain Holy Anointing Oil composed according to the Art of the Apothecary; and that herewith thou shalt anoint the Tabernacle of Testimony and the Ark of the Covenant, the Table with its Vessels, the Candlesticks, the Altar of Incense and that of Burnt Offering, and all things pertaining unto the Cult.⁴

¹ From this point on to the end of the book, the whole of the original MS. is in execrable and obscure Latin.

² See Ezekiel.

³ See Exod. xxx.

⁴ Here by an evident slip the Characters of the Spirits of Joy are given a second time.

THE RATIONAL TABLE: or the QABALISTICAL LIGHT; PENETRATING WHATSOEVER THINGS BE MOST HIDDEN AMONG THE CELESTIALS, THE TERRESTRIALS AND THE INFERNALS



THE FIRST CHARACTERS

The First Characters which should be made upon virgin parchment, on Sunday in the Hour of the sun (see Figure 46), The first letter of your name should be written in the semi-circle 'A', and that of your surname in the semi-circle 'B'. You should wear this upon your left side (near the heart) before you proceed to invoke the Spirits, in order to make them obey you, and to gain from them that which you shall desire.

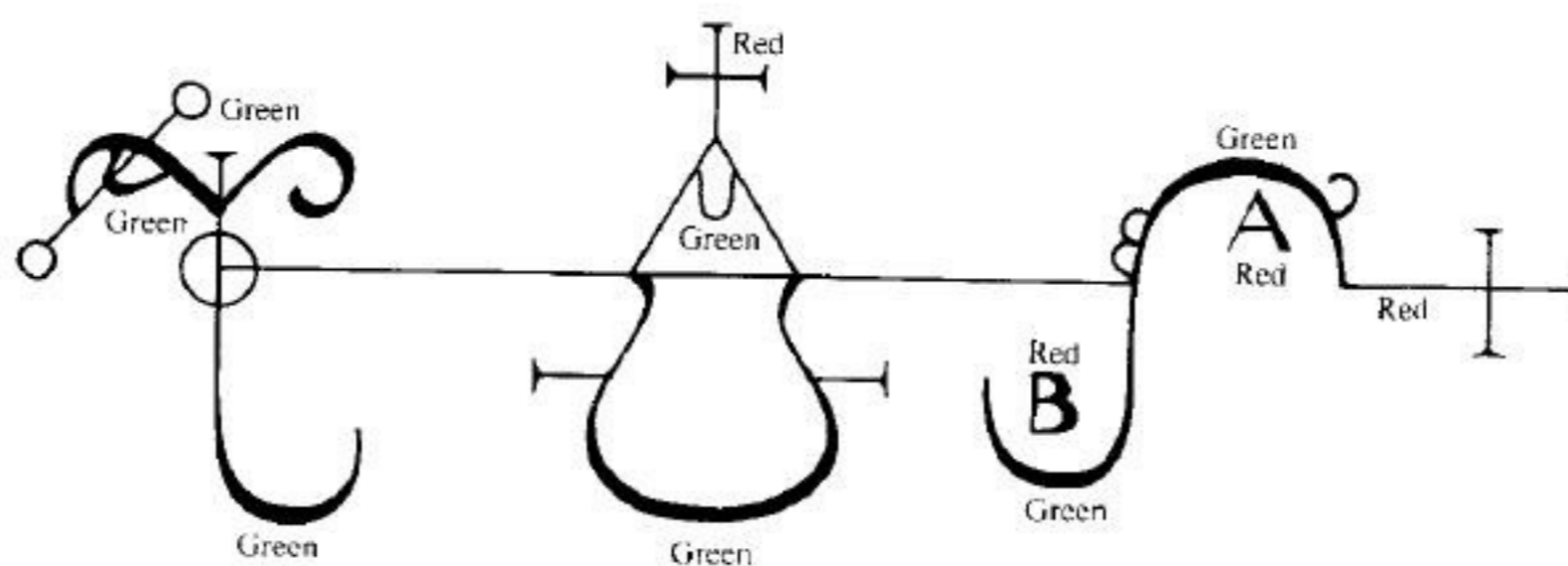

FIGURE 46

ISRAEL hath gone forth from the Beginning, from the Days of Eternity. O my Soul, possess thyself in searching out and following out in thyself the Will of thy Lord PELECH Who is JESUS; for that Peace shall be thine, when M e m o r o t h the Assyrian and M e t r u m shall come to turn thee from the Eternal Law, and thus disturb thee in all thy ways.

Be unwilling to fast,¹ O my Soul; let it be at the hour of Day that thy cry may be heard on high. Is it also such a fast which the Lord hath chosen to afflict thee by day, through the depth and multitude of my iniquities, whereby I have excited thy wrath, and have done evil before thee unintentionally, also I have kept thy commands.²

The Lord God presseth me hard because of my many sins; nevertheless bow down (unto Him) O my Soul; that thou mayest rather fall into the hands of the Lord God, seeing that many are His Mercies, than into the hands of Man. Turn then, O my Soul and humble thyself before the Lord thy God. The Lord thy God hath created Israel, and truly there is a Providence which acteth in the sight of God; and him who hath cried unto Him, also He observeth intently, and listeneth unto his prayer.

Cry unto the Lord, with great insistence, and humiliate thyself O Soul, also in Chastity, in fasting, in mercy, in power, seeking out with thine whole heart in thy prayers the Will of the Lord God, and all things shall be added unto thee. From thine inmost heart and in tears shalt thou say unto the Lord thy God, 'I have sinned, nevertheless O Lord return unto me whom Thou hast humiliated.' Be in thine whole heart ever seeking Jesus, in chastity and in sobriety, in mercy and patience, and thus shalt thou possess the Soul in faith, hope, and charity; and thus shalt thou pray confidently. And whatsoever thou shalt seek in *Bereshith*,³ shall be given back unto thee in *Mercavah*.⁴

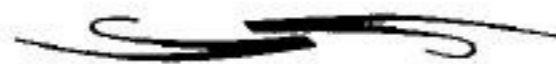

¹ *Noli jejunare.*

² Like nearly all the latter part of the MS. this paragraph is most obscurely worded in Latin.

³ The Beginning of Genesis.

⁴ The Vision of the Cherubim in Ezek. i. called also 'Mercavah' or 'the Vision of the Chariot'.

THE VISION OF ANOINTING

Hath it not been written in the Scriptures, — 'Take unto thee sweet spices, five hundred shekels of myrrh the finest and most choice, likewise thou shalt reckon two hundred and fifty shekels of Calamus,'¹ Are these not in the Blood, Vital and Animal Spirits? Is there not Blood in the whole Body? And there is (a certain proportion) of fat joined thereunto preserving the Spirits thereof. In the Body of the Fish preserved by Tobias were there not these Spirits (derived from) the purest faculties of all true Elementary Forces? Know thou then what most holy thing existeth as regardeth (these Elementary Forces) preserved in Nature!

Therefore the Lord *Pelech*,² now *Jesus*, by His Omnipotent Grace mercifully operating in Nature, protecting the Heart of the Operator in Simplicity, in Faith, in Hope and going forth in Charity, rejoicing also in Itself, directeth such Spirits according to their most sacred faculties to cooperate with such Operation of a Simple Heart.

Is it not manifested in the Book of Tobias, who himself was of a Simple Heart, that the Lord God directed the Spirits of the Liver of the Fish according to their most secret faculties, in His Adorable Name, by His Angel Raphael, to co-operate with Tobias in the casting away of the Albumen (from the eyes of his) father?

By a Number (namely) through the Ternary, is the Mercy of God the Highest Lord, *Jah*, turned, therefore revealing all things. David took unto himself five most clear stones from the Brook and five cakes of Shewbread, the which Bread the Laity might not have, but only the Elect. Is not the Head the seat of Imagination, of Memory and of Intellect?

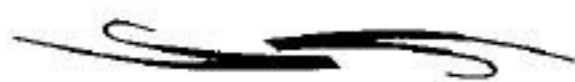

¹ See Exod. xxx. 23.

² P L C h = 118, to pass, renew, change, to ferment (in Hebrew) פ ל ח

COR ERGO ET SCIETUR UNUM SUNT
PUTREUS M ALE STUM¹
THE VISION OF DUST²

Wherefore let it be granted that dry bones having been reduced in to a most fine powder, that this also may be refined and compounded together like unto the *T h i n i a n a* of *Moses* the Blood. Neither ever hereafter shouldest thou despise this holiest Mystery; for thee the Spirit of Life is herein like as in the Dust of a Man.

Since all these (matters) have been placed before thy true heart, which also the Lord God hath chosen for the legitimate Tabernacle, may He further bless all thy works in thy time!

By His Angel *Raphael* He appeareth unto the blessed Tobias and in his journey he put to flight all Malice of heart and every kind of Demon which obsesses, and (caused) Simplicity of heart, Purity and Faith in Prayer to have entire dominion with him.

Is there not sought in the Imagination those things which one hath not known, and is there not pleasure in the excitation thereof? Hath not Memory been willing to aid that which the Imagination hath clothed with form, so that one may see of what nature such things may be and whether any further development of them may be (advisable)? Hath not the Intellect having applied them unto Itself, known how to treat in thee the things cast forth by the Memory, and this to what degree and extent according unto their faculties and powers? Do not Memory, imagination, and Intellect operate (simultaneously) together? For at once and in unity these (three) which be united together do then become Intellectual Action. Is not the Heart a recurved Vase of Blood? If among all these so many be found similar that they may be perfected hereunto, it will be the same concerning His people.³

Study this well O Man, ardent for Wisdom, in the following out of this Path desiring all things, seeking all things, and understanding all things, seeing that in thyself⁴ are all things.

¹ This piece of mutilated Latin is very difficult of translation. I suggest the following: 'Therefore let it be understood that the heart which is one thing yet when decaying is reduced into a bitter powder,' taking 'M ale' for 'Malleatus' and 'Stum' for 'Stymma.'

² *Visio Stile*. This word *Stile* probably stands for dust but it may also be a perversion of 'Still' from 'Stilla' a drop, as a drop of Dew.

³ This whole sentence is very obscurely worded in Latin.

⁴ *In ipso*.

Assimilated; Contained: Willed. Was it not on the Fifth Day⁵ that Man was made a Living Soul?

Was there not a Soul⁶ which came forth (into manifestation) on the Third Day? Did it not also give forth and withdraw (the faculty of) Hope, and before that it withdrew, did it not rejoice in the Quinary Number;⁷ going forth and returning in that same Number; for it rejoiced in the Nature of the Creatures which do exist in the Number of the Quinary.

First God, (then) Spirit and Matter. Most powerfully do these operate the separation of Matter violently transformed by Life. How can such (Life) do aught but delight in the Number of the Five, seeing that therein is hidden every Mystery of a (Past), Present and Future Age, since in such (Eternal) Epoch is the Name of the Lord God.

Also in the Prophecy of Ezekiel, as it was taught unto him, the Lord God said: 'Let the Spirit come from the Four Winds,⁸ and brood over these that they may revive in the Name PELECH, now JESUS.' The Lord God PELECH, now JESUS. The Spirit having entered into them, also they spake. It is not also related by inspiration that the Lord said unto Moses: 'Take unto thee Aromatics; Stacte, Galbanum of good odour, and thus Luci, of equal weight:⁹ hereof shalt thou make a perfume composed according to the Art of the Apothecary, mixed with care; pure and sanctified, and most fitting to be offered unto me. And when thou shalt have beaten it into most fine powder, then shalt thou place it before the Tabernacle of the Testimony in the which place I will appear unto thee, Holy of Holies shall it be. Thou shalt compose nothing similar for thine own use, seeing that it is Holy unto the Lord.' Man who was called Adam, also called by their (true) Names all the animals, as well the Birds of Heaven as the Beasts of Earth, But there was not found an aid for Adam who was like unto him.¹⁰

Is it not written and reported by tradition¹¹ that the Lord God led forth Ezekiel in His Spirit, and left him in the midst of a field which was full of dry bones, and led him round about these bones in that region, and prophesied over those bones. And in the Name of the Lord he said unto them: 'O Dry Bones, hear ye the Word of the Lord! Thus said the Lord unto you: "So therefore

⁵ ?Sixth.

⁶ i.e., that Germination of Life on the Earth.

⁷ i.e., that of the Spirit and the Four Elements, (that is, the Creative.) cf. the Cherubim and the Elemental Spirits.

⁸ i.e., as it were the Ethers of the Four Elements, see Ezekiel.

⁹ See Exod. xxx. 34 *et seq.*

¹⁰ See Gen. ii. 19-20.

¹¹ Ezek. xxxvii.

will I send forth My Spirit unto you, and ye shall live, and ye shall know that I am the Lord." Also thus was it done at the same time that Ezekiel did prophesy over those dry bones.'

Since in that prophesying there was a sound made, and behold there was a great movement, and the bones approached and joined each unto the other together, and the nerves and flesh formed upon them, and the skin was spread above, though as yet they had not the Spirit of Life. Unto that Spirit, then did Ezekiel prophesy his Will, in all humility, sobriety, mercy and patience. And though, whosoever thou mayest be, who in thy life and action possesses thy Soul in peace, when therefore thou shalt know the *Mysterium*,¹² be thou well ware not to reveal it. When the Spirit willeth seek to enter into the Knowledge of the Lord, and there shall rise an intellectual fountain of Understanding and Wisdom. The (celestial) LIGHT fleeth the (Earthly) Light, and operateth in Secret until thine Heart is tormented with understanding and with the desire of Understanding, since it is that which seeketh and which is hidden from Man. Is it not written and reported by tradition, and hast thou not read, that the Lord God formed Man of the Mud¹³ of the Earth, and that Man became a Living Soul, and that when He had formed Man He placed him in the Paradise of Pleasure to work it and to keep it.

And seeing that the Lord God, having formed from the ground all the animals of the Earth and all the winged things of heaven, did bring all these living creatures before Adam himself, then did his Name (that is) the Spirit (or Breath) go forth (upon them); and the Dust¹⁴ being arrested, there did it remain, and the Rose¹⁵ was restored. And so also is the Man who understandeth the Mysteries of the Book, and of the Similitude of the Rose, and the Mystery of the Dust; preserving the same in the inmost of his heart like a Magically guarded Treasure¹⁶: and as a Gift of the Highest, most sacred and most unutterable nature. But shouldest thou make an abuse hereof, then shall it be unto thee as a most heavy and scandalous thing and shall bring about the utter ruin of all thy worldly possessions, of thy body, of thine intellect, and of thy Soul. Further also take heed that thou reveal it not to any in writing, nor yet even the least part of the Mysteries of this Book. Wherefore mayest thou be contented herein, with all charity and zeal thereof, and thou shalt have done sufficient; for God knoweth who desireth truly for His Grace, His Light and the Understanding of His Empire; seeing that in His Name he hath known Him.

¹² Cf. the 'Mysterium' of the Rosicrucians.

¹³ *De limo terrae.*

¹⁴ Or 'Drop' or 'Grain'.

¹⁵ i.e., the Rose of Creation.

¹⁶ *Tanquam thesaurum imprecobilem.*

When thou shalt have comprehended the *Misterium Stile*,¹⁷ which is the Most Holy Gift of God, this is that which the Lord God PELECH now JESUS revealeth or permitteth to be revealed unto those who do seek His Will.

Is it not reported by tradition and written 'In the Beginning the Elohim created' (Bereshith Bara Elohim) . . . Man on the Sixth Day; whom the Lord God took and placed in the Paradise of Pleasure, wherein was the Fountain divided into Four Heads. There is that Most Holy Mystery, let him who hath ears to hear, hear and live! O Lord God, may he be Anathema (accursed) whosoever he be, who shall have despised this most precious Mystery. Amen!

Hear, O my Soul, turn unto the Lord thy God; for where there hath been Pride, there shall be also Abasement; but where there is humility (there is) also Wisdom. So, therefore, abide fast in the Lord God, saying with thine whole heart, 'Truly I have sinned in all my ways, but I beseech Thee O Lord to take away the Iniquity of Thy Servant, seeing that nevertheless I have put my trust in Thee!'

O Lord God, thou art become my oppressor, because of the multitude of my sins, seeing that I have greatly sinned, and that mine Iniquities be multiplied like unto the Sands of the Sea, and I am not worthy to lift up mine eyes unto the Height of Heaven.

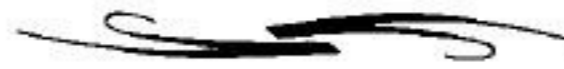

¹⁷ The Mystery of the Dust or of the Drop.

THE PREPARATION OF THE SOUL (I)

Before invoking the Spirits it is necessary to make a (Magical) Circle, and place thyself in the midst thereof after having sprinkled the same with Holy Water saying:

*'In Nomine Patris + et Filii + et Spiritus Sancti.'*¹

'In the Name of the Father, and of the Son and of the Holy Ghost.'

*'Respice in me per Sanctissimos Angelos Tuos in Nomine Jeus de Maria Virgine semper immaculata Nati, et Veritas Tua manet in aeternum— Amen.'*²

'Examine me thoroughly by Thy most Holy Angels, in the Name of Jesus, born of Mary, the ever Immaculate Virgin; and may Thy Truth endure for ever— Amen.'

Before the Oration prepare thy Soul, and be not thou like unto a man who tempteth a God.

ORATION SEMPER PRECEDENS ACTUM

(Dirigatur quaese et humillime.

Deprecor Domine Deus Meus Omnipotens in conspectu Tuo Operatio mea et comittentier mihi et operatione mea sanctissimi (here follow a collection of scratches evidently intended to represent Hebrew Letters which I imagine are intended to stand for the words: 'IHVH Elohim, Ab, Ben Ve-Ruach Haqodesh.' 'Tetragrammaton Elohim, Father, Son and Holy Spirit.')

Ad Majorem Nomini Tui gloriam, edificationem et utilitatem proximi mei. Amen.

Translation of the Foregoing.

THE ORATION ALWAYS TO BE MADE BEFORE OPERATION

(also I warn you that it is to be performed with the greatest humility).

¹ Make the Sign of the Cross at each Cross.

² I give the exact Latin of the original MS. here and in other cases.

In Thy Sight O Lord mine Omnipotent God, do I pray for mine Operation, and may these most Holy (Names) be in charge over me and my Operation . . . unto the Greater Glory of Thy Name, and the edification and profit of my neighbour. Amen.

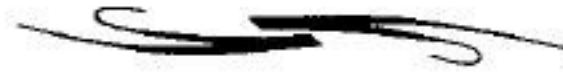

THE PREPARATION OF THE SOUL (II)

Santi Andrea et Thoma circumvallate me.

O Saint Andrew and (Saint) Thomas, be a defence about me.

Sancte Michael auxiliante omnibus operationibus meis quoniam quis sicut Dominum Virtutum et nullus certe ni ni solus deus meus magnus et terribile super omnes qui in exercitu ejus sunt ideo enim voto voverint domino Deo meo Jesu me possidentis et circumvallante gratia sua et dominus Deus Jesus imposita mihi Lege sua sit mihi semper a cunctis diebus et momentis vitae meae in patrem et deum meum— et si vere Emmanuel amabilis.

O Saint Michael bring thine aid unto all mine Operations, for who is like unto the Lord of Virtues; and assuredly there is none else but my Lord God, the only Great and terrible over all who be in His Army, for hereunto by vow are they vowed unto my Lord God Jesus, Who possesseth and defendeth me by His Grace. Also may the Lord God Jesus having imposed upon me His Law, be ever mine in every Day and moment of my life as my Father and God, and thus truly my beloved Emmanuel.

Sancte Petre ad glorium et utilitatem proximi ure in me omnes iniquitates meas.

O Saint Peter, unto the (Divine) Glory and the good of my neighbour, burn up in me all mine iniquities.

Sante Paule obviam este deprecationis meae.

O Saint Paul, be thou propitious unto my prayer.

Confitebor Jesu tibi Christi rex Aeternae gloriae verbum caro factum est, ex Maria de Spiritu Sancte te humillime deprecor per vulnere tua sanctissima quae sunt fons regenerationis nostrae in fide et charitate per delectissimam Mariam Matrem tuam semper immaculatam et omnes sanctes tuos ne impediar opere ad mortem justificari in fide et charitate quoniam fides sine operibus mortua, non nobis domine non nobis sed nomini tuo, nequando dicant gentes ubi est.

I will confess myself unto Thee, O Jesus Christ, King of Eternal Glory, the Word is made flesh from Mary by the Holy Spirit; I pray Thee most humbly by Thy most holy wounds which are the Foundation of our Regeneration in Faith and Charity; by Thy Most delightful Mother Mary, ever Immaculate; and by all Thy Saints let me not be hindered in my work, unto death be justified in Faith and in Charity, since Faith without Works is dead. Not unto us, O Lord, not unto us, but unto thy Name; lest the heathen may say: Where is He!

Let us become as little children at birth, for unless we be born again we shall not see the wonders of God, nor yet in any way progress in the Art.

Good is fasting with prayer, and almsgiving, and vow.

Before the Oration, prepare the Soul!



THE CHARACTERS OF MICHAEL

Therefore Hear O Man! The Lord, the Lord Our God, is one Lord. Thou shalt love the Lord thy God with thine whole heart, with thy whole Soul, and with thy whole strength, and thy neighbour as thyself. And these words which I teach unto thee shall be in thine heart, thou shalt relate them unto thy children and thou shalt meditate upon them, when thou sittest in thine house, when thou walkest by the wayside, when thou sleepest, and when thou arisest; and thou shalt bind them like unto a staff for thine hand, and thou shalt place them between thine eyes and thou shalt write them upon the threshold and portals of thy dwelling place. AMEN.

Thou shalt not tempt the Lord thy God, in any soever of thy works; but keeping His precepts and testimony, and ceremonies, most pure, thou shalt do that which is pleasing and good in the sight of the Lord with zeal and charity, not out of curiosity or ostentation.

If thus thou shalt have heard the voice of the Lord thy God and shalt have walked in his ways, that thou mayest do and keep His commandments, the Lord thy God shall make these more excellent than all the Nations which be spread abroad upon the Earth; and by reason of that blessing shall they come unto thee and learn of thee, Blessed shalt thou be in the City, and blessed shalt thou be in the field, and blessed shall be the fruit of thy body. AMEN.

But the God of these, Who is also our God, is in Heaven, and in Earth, and in the Abyesses, and He doeth whatsoever He will. They who fear the Lord have put their trust in the Lord, He is their helper and defender. Would that my life were directed to the safeguard of thy justification. Also I have sought thee out, because thou hast caused me to have life hereby. Let it go forth unto my works. Direct thou them according to Thy saying, and let not injustice have dominion over me!

When, therefore, thou shalt be worthy to understand in what manner thy vow and thy natal day are to be observed with circumspection and purity:

Take note of this:

Are there not twelve Months in the Year?

Is there not one hour in each single month?

Does not this hour pass by?

And thus let it then pass by with chastity, fasting, ardent prayer and desire, desiring also your Vow by the Divine inspiration and therefore fit to be carried out.

This following is a fitting prayer.

ORATIO

Initium Sapientiae Timor Domini in Nomine Dei Israel, Uni et Trino, Credidit Abraham et ei reputatum fuit in justitiam. AMEN.

TRANSLATION OF THE FOREGOING

The Fear of the Lord is the Beginning of Wisdom. In the Name of the God of Israel, One and Triune, Abraham believed, and it was counted unto him for righteousness. Amen.

Nisi Dominus Operitus nobiscum in vanum laborant qui operantur.

Unless the Lord work with us, in vain do they strive who labour.

De Profundis Clamavi ad Te Domine, Domine Exaudi Orationem meam.

Out of the Depths Have I cried unto Thee O Lord, O Lord hear my prayer.

Fiant aures tuae intendentes in vocem Deprecationis mea.

Let Thine ears be inclined unto the voice of my supplication.





LIBER ARMADEL¹

Seu totius Cabalae perfectissima brevissima et infallibilis Scientia tam
speculativa quam practiqua

Dominum Deum timebus et illi seli serbies per nomen

illius tremendae at adorabilis Majestatis omnibus

diebus vitae tuae.

operaribus

FIN



¹ This is a reproduction of the original title-page.