



# MARKER BINDINGS

PROGRAM

2013/14

WWW.MARKER.NET

MARKER



## THAT'S NEW

# OUR ROYAL HIGHNESS - OUR ROYAL APPROACH

Majestic mountains and divine downhill — the Royal Family line from MARKER features the perfect bindings to reign over every descent like a king. The expectations are extreme, but so is our motivation. Last year we introduced the Duke EPF, once again raising the bar by numerous notches. The current MARKER collection now seeks to spread this performance beyond freeriding to all other disciplines. Performance growth is the motto of the '13-'14 season:

### **Extended EPF**

MARKER's Extended Power Frame wowed through its ability to extend the Duke's power transfer range. That construction is now available starting immediately in the Tour EPF and Baron EPF as well. Power for everyone!

### **LORD SP**

The newest member of the Royal Family is the ideal synthesis of freeride and alpine binding come true. Compatible with all current ski and touring ski boot soles, the LORD SP comes with a all condition-ready magnesium casing specially designed for snow specialists as ONE binding for all situations.

### **Race Xcell**

Completely redesigned and imbued with unbelievable power, the new Race Xcell binding can handle the most extreme stresses of modern racing. The revolutionary Xcell technology in the toe pieces sharp, high-frequency jolts helping to prevent pre-releases and centering the boot, while the enlarged contact surface ensures maximum precision in the connection between boot and binding.

### **U.V.O.**

The Ultimate Vibration Object is the first system on the market with 360° dampening! While other constructions function only along the longitudinal axis, the U.V.O. absorbs shocks and soaks up undulating surfaces keeping the skis on edge and track and providing significantly more control without compromising the liveliness and response.

You'll read about all this and more on the pages that follow. And may your winter be as snowy as it is successful!

### **The MARKER Team**

### **RACE XCELL SERIES**

08-09

### **THE BARON EPF**

13

### **TOUR 12 EPF**

16-17



**+ AFD Stainless Steel**

All MARKER bindings are equipped with a moveable AFD (anti friction device) leading to a highly precise release almost entirely unhindered by dirt, snow and ice! Individual adjustment of the AFD to the area of application ensures perfect functionality - from racing, for children's bindings or on ski tours.

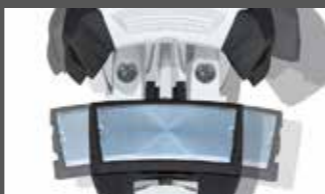
**+ Biometric Pro**

During a backward twisting fall both horizontal and vertical forces are triggered on the toe of the binding. Biometric Pro recognises this unfavourable force combination and reliably reduces the release force. The mechanism is made of high quality construction materials and allows a Z-value dependent backwards release. This feature is exclusive to MARKER.

**+ Biotech**

During a backward twisting fall both horizontal and vertical forces are triggered on the toe of the binding. Biotech recognises this unfavourable force combination and reliably reduces the release force.

**+ Triple Pivot Elite Toe**

The toe construction with DIN/ISO up to Z 18 allows for impressive retention when freeriding. The spring in the toe is inserted horizontally and with a sole plate inclined by 5° it provides the highest energy absorption so as to reduce the risk of early release. The large supporting surface optimizes the power transmission and allows for great stresses and strains. In relation to their weight, toes with this technology therefore achieve a never-seen-before performance.

**+ Triple Pivot Light Toe**

The newly designed, compact toe features a horizontally inserted spring. Together with the gliding plate the gliding elements integrated into the sole holders ensure a very precise release behaviour which is comparable to all other MARKER bindings. Why should touring skiers and freestylers accept any compromises? An aluminium bridge on the top provides additional support without adding any extra weight.

**+ Triple Pivot Comfort Toe**

When designing the toe, maximum functionality and a low weight were the order of the day. This resulted in a lightweight binding system that in addition to excellent release properties also provides an individually tailored backwards release. The entire binding is completed by its unbeatable design. The horizontally inserted release spring allows for a compact design and results in a very direct ski binding for optimal power transmission.

**+ Intelligent Backward Release**

Intelligent Backward Release clearly differentiates between forces that occur during a backward twisting fall and moments of force that originate from a movement onto the edge of the ski to enter into curves. An individually adjusted spring reliably regulates the backwards release without any loss of performance.

**+ TLT**

Two Linkage Toe - Light and robust with a high level of functionality. Full lateral and backwards release. DIN range 2.5 - 10. The release spring is controlled by the sole plates and also takes over the backwards release via the cleverly devised TLT system. This saves weight and space.



## TECHNOLOGY

**NEW XCELL Technology****+ Twin Cam X Heel**

The next logical step in the improvement of our TwinCam heel, with more power, higher elasticity in the release and an optimized performance curve. The new construction increases the boot and ski connectivity for a longer period, even in extremely steep terrain, ensuring precise ski guidance until released. It also offers improved power transfer through the wider connection of the heel rail (NEW: 43 mm). The TC heel's familiar effective step-in behavior has also been further improved.

**+ Xcell Toe**

The new toe pieces with magnesium sole holders (on the Xcell 16.0) stand out for the large contact area with the boot sole, top power transfer and impressive shock absorption. The unique Xcell technology makes it possible to filter out short jolts and keep the ski boot perpetually centered. The new Xcell binding also offers what's likely the most radical design in racing and inspired by F1 design.

**+ Inter Pivot Heel**

The stunning heel construction delivers superior holding power for free riding, featuring DIN/ISO 6-16. The Inter Pivot Heel directs the power forces in the angle of elasticity improving the holding power and reducing pre-releases.

**+ Twin Cam Heel**

The two-piece TwinCam Heel is designed with a unique soft-entry feature. Step-in more quickly and easily, even in difficult snow conditions.

**+ Hollow Linkage Heel**

The heel was also redesigned from the ground up to optimize retention for all types of alpine and touring soles. The aluminium hollow axle saves on weight and maximizes the torsional stiffness. This very robust heel construction is best suited for the most strenuous of requirements.

**+ Comfort Heel**

For this heel the technology of the high-end bindings was adjusted to meet the requirements of sporty skiers. The release spring is inserted into the heel housing and thus allows for a very compact design and a heel housing angle which leads to an ideal release elasticity. The hollow axle and the high quality materials ensure that the binding is lightweight and looks great.

**+ Compact Heel**

A statement of efficiency - with the usual perfect MARKER release properties and the perfect mix of great design, lightness and excellent functionality. This heel technology is perfect for beginners and occasional skiers due to the release properties and is an excellent value.





**+ SP Technology**

New Ski Patrol binding system optimized for the greatest possible range of situations, adjustable height toe pieces on the LORD S.P. can handle all types of ski boots, including both alpine and touring models and standards. Top power transfer on any terrain, despite minimal overall height profile.



**+ Magnesium Parts**

Magnesium is THE lightest and most robust metal construction material making it perfect for our high-end products. This makes you well equipped for a faster run and the most radical lines!



**+ Piston Control**

The inner life of the World Cup Plate. A hydraulic oil piston enables sensational performance on the race track. The piston only reacts to negative ski impacts. This noticeably improves the turn initiation, increases the edge grip and allows more precisely controlled turns.

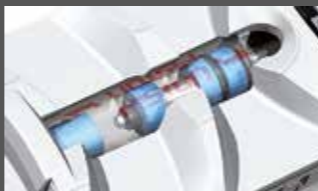

**+ Glide Control D-System**

MARKER brings an exceptional demo-capable binding component onto the market with the Glide Control System. Here the focus is on a low stand height, low weight and excellent performance. The innovative technology of the Glide Control Binding allows any boot (263-374 mm) to be quickly and easily adjusted via the central lever.



**+ i.roc compatible**

Our i.Roc compatible gliding plates work perfectly with the Dalbello i.roc system without an detriment to other ISO standard soles. The i.roc sole adapter combines a rocking arch at the front with special grip areas for optimal ski performance and improved, more comfortable walking.



**+ Multi-Stance Adjustor**

Going wild in a park or in backcountry requires a different skiing technique. When doing jumps and new school tricks you need to be centered on the skis for optimum balance. In powder though, setting the binding back a little improves ski flotation tremendously and less force is needed. The Multi Stance Adjustor offers 60 mm continuous travel for perfectly balanced riding position.



**+ EPF - Extended Power frame**

The power booster. The new power frame, exclusively designed for the new Duke EPF, delivers breath-taking performance and amazing power transfer in every condition. Recommended for skis over 88 mm.



**+ Power Width Design**

Designed with a low, level stand height for maximum power transmission. It's the shortest frame of all hiking models in the market, yet featuring a 10 mm wider interface than traditional "racing" bindings. Connecting brackets are strategically placed in the power transfer areas for immediate edge control. Recommended for skis over 76 mm.



**+ TÜV**

All MARKER bindings are certified by the TÜV organization.



# TECHNOLOGY



**+ Backcountry Technologie**

The uphill hiking mode integrated in the Duke binding features easy adjustment from ride to hike. The hiking aid offers a 7° and 13° position. In ski mode the BCT lever is protected from unwanted releases. A 40 mm backward movement of the binding in BC mode results in a better balanced swing weight and easier kick turns.



**+ Backcountry Comfort**

The patented, ergonomically shaped lever under the boot allows comfortable opening and closing. The position prevents the binding from unwanted release and provides unparalleled security against an undesired "telemark" situation.



**+ Climbing Aid**

The titanium climbing aid offers two positions with 7° and 13° which can easily be accessed with the ski pole, even in an unstable standing position. Integrated elastomer paddings dampen the impact reducing the irritating traditional "clack" and allow more comfortable hiking.



**+ Touring Base Plate**

The wide frame construction is secured at several positions, perfectly distributing the pressure for unparalleled skiing performance. 2 sizes are available for optimum size range and stocking efficiency.



**+ Touring Balance**

Switching the lever to touring mode moves the whole binding 40 mm backward, allowing a more comfortable walking position and keeping the ski optimally balanced for kick turns and steep terrain.



**+ Hollow Tech**

Our fibre-reinforced frame base plate provides impressive riding stability and is yet very light due to the gas injected hollow construction.



**+ Touring Brake**

The brakes can easily be removed – even by the end user. Just remove the two fixation screws, slide off the brake, remove the brake arm, and re-install the heel spacer. The wide platform for the boot provides power transmission. Standard safety straps available on the market are adaptable to the F10 and F12 Tour models.



**NEW**

**RACING  
8**

# COMPETITION

XCELL TECHNOLOGY

The revolutionary Xcell technology in the toe pieces holds the boot perfectly centered and absorbs even the hardest jolts to the ski. Taken altogether, this translates into fantastic control of the ski. The new racing bindings from MARKER feature premium quality magnesium components (16.0 model), a broader sole contact surface and the

innovative, x-shaped damping mechanism in the toe pieces to deliver uncompromising world-class racing performance on all courses. The Xcell system is complemented by the new Race Xcell heel, which provides similar world-class power transfer and elasticity in the release.

# XCELL



## Race Xcell toe Technology



- >> Compensation of short impacts
- >> Boots stays centered
- >> Reduction of pre-release issues
- >> Excellent steering quality
- >> More precise



- >> 100 % more energy absorption
- >> 16 mm travel until the release point
- >> Wider contact points (sole holder & break)

## Race Xcell heel Technology

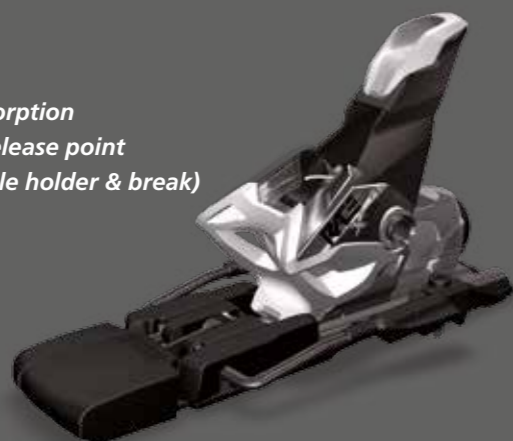

■ Comp 12  
■ Race Xcell 12

- >> Wider heel rail
- >> Easier step-in
  - Due to angle of sole holder (angle plus 5°)
  - Opening lever is active in both directions (open/close)

**RACING  
INTERFACES**

**9**

**NEW**



**XCELL  
16.0**

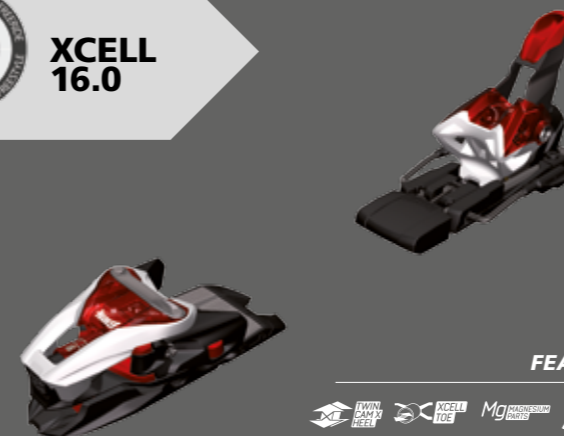

### FEATURES



The new racing machine from MARKER with DIN settings up to 16. The incredible absorption properties and large contact surface to the ski boot make it almost unbeatable on rock-hard race courses, without compromising on protection. The magnesium heel housing, Xcell toe piece and Xcell heel feature a radical design and a Formula 1 look. A must-have for ambitious racers.

DIN RANGE	6.0 - 16.0
RECOM. SKIER'S WEIGHT	60 + kg
STAND HEIGHT W/O SKI	19 mm
TOE SYSTEM	Xcell Toe
AFD GLIDING PLATE	stainless steel
STEP-IN HEEL	Twincam X
EPS SYSTEM	X
COLOR COMBINATIONS	black - white - red
WEIGHT (PAIR)	2356 g
ART. NO.	6920N1WA

**NEW**



**XCELL  
12.0**



### FEATURES



The design is identical to that of the Xcell 16.0, but with DIN settings tailored to young racers and with lighter weight resin sole holders.

DIN RANGE	4.0 - 12.0
RECOM. SKIER'S WEIGHT	< 120 kg
STAND HEIGHT W/O SKI	19 mm
TOE SYSTEM	Xcell Toe
AFD GLIDING PLATE	stainless steel
STEP-IN HEEL	Twincam X
EPS SYSTEM	X
COLOR COMBINATIONS	black - white - red
WEIGHT (PAIR)	2294 g
ART. NO.	6820N1WA

**NEW**

## WORLD CUP PISTON CONTROL INTERFACE



### FEATURES



High-speed racing like the pros. Thanks to Piston Control, an integrated hydraulic oil piston, even the smallest bit of energy is converted into speed. Now compatible with the new Xcell bindings.

WORLD CUP PC INTERFACE GS / SL	12 mm / 10 mm
WORLD CUP PC INTERFACE 14 MM	
HEIGHT FRONT / REAR	16 mm / 14 mm
WIDTH / LENGTH	59 / 542 mm
SOLE LENGTH	260 - 362 mm
ART. NO. WC PC Interface GS / SL	2020N1MW -
WC PC Interface GS / SL Bulk	2020N1MC -
WC PC Interface 14 mm	2022N1WS -
WC PC Interface 14 mm Bulk	2022N1WB -

RACING  
10



COMP  
20.0  
EPS



The Comp 20.0 EPS comes with race-proven features like Magnesium sole-holders, Biometric Pro protection and World Cup brakes. Now with lower stand height (18mm heel).

DIN RANGE	11.0 - 20.0
RECOM. SKIER'S WEIGHT	60 + kg
STAND HEIGHT W/O SKI	18 mm
TOE SYSTEM	Biometric Pro
AFD GLIDING PLATE	stainless steel
STEP-IN HEEL	Twincam
EPS SYSTEM	X
COLOR COMBINATIONS	white - red
WEIGHT (PAIR)	2700 g
ART. NO.	7120M1WM

FEATURES



UVO  
11

NEW



THE ULTIMATE  
VIBRATION  
OBJECT



A new era in performance skiing — the new U.V.O. The dampening system from MARKER is the first in the history of skiing to offer 360° dampening for the ski. While traditional systems account only for the longitudinal axis, the U.V.O. system works in all directions. It compensates for unwanted vibration in the ski, with no detriment to agility. The results are an impressively quiet ride even at high speeds, with greater precision through turns and in particular greater control on rough surfaces.

- Improved ride quietness
- Greater precision
- Greater control
- Destined for on-piste use



ART. NO. V001M1S

**i** HOW TO MOUNT THE UVO > VIDEO + INSTRUCTION ON: [EXTRANET.MARKER.NET](http://EXTRANET.MARKER.NET)



12.0 TC  
COMP D  
SYSTEM

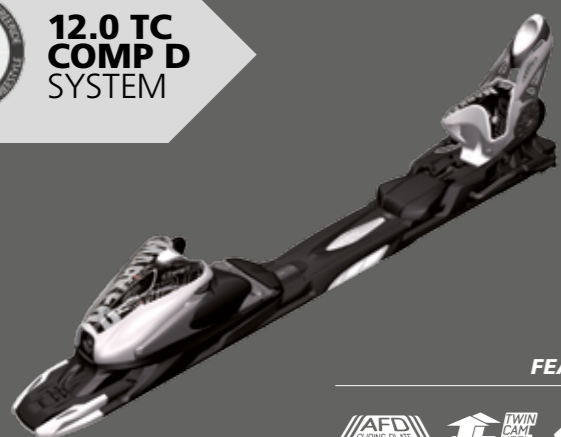

Proven MARKER racing features, Twin Cam heel and Biometric Pro four linkage toe. For skiers looking to build that high speed, this model won't disappoint and the built-in demo feature will assist in proving this point.

DIN RANGE	4.0 - 12.0
RECOM. SKIER'S WEIGHT	< 120 kg
STAND HEIGHT W/O SKI	19 mm
TOE SYSTEM	Biometric Pro
AFD GLIDING PLATE	stainless steel
STEP-IN HEEL	Twincam
EPS SYSTEM	X
COLOR COMBINATIONS	white - black
WEIGHT (PAIR)	2750 g
ART. NO.	6978M1WS

FEATURES



M 10.0  
COMP  
EPS



The M 10.0 Comp EPS offers exactly what racing kids need: the perfect entry in the MARKER racing circus. Works great in combination with the Jr Race Interface.

DIN RANGE	3.0 - 10.0
RECOM. SKIER'S WEIGHT	30 - 110 kg
STAND HEIGHT W/O SKI	19 mm
TOE SYSTEM	Biotech
AFD GLIDING PLATE	stainless steel
STEP-IN HEEL	Compact
EPS SYSTEM	X
COLOR COMBINATIONS	white - red
WEIGHT (PAIR)	1700 g
ART. NO.	6520J1WA

FEATURES



JR  
RACE  
INTERFACE



Derived from the World Cup Interface, the Jr Race Interface has been newly established with a new plate that can glide freely along a precision steel guidance bar. The flex has been harmonized for youth skis and lighter athletes, and in particular for short ski lengths. Compatible with all MARKER Race Xcell and Comp bindings.

HEIGHT FRONT / REAR	16mm / 14 mm
WIDTH / LENGTH	59 mm / 495 mm
SOLE LENGTH	210 - 334 mm
ART. NO.	2027K1WS

NEW

VIBRATION REDUCTION WITH UVO

1. Movement of the shovel along the Z axis (vertical: up/down along the direction of travel): Stabilization of the shovel at high speeds and on choppy surfaces
2. Movement of the shovel along the Y axis (horizontal: left/right along the direction of travel) Less "chatter" on hard surfaces
3. Torsion along the X axis (length of the skis) Reduction of shovel torsion. Direct power transfer that reduces loss of edge energy and grip; quicker, more reliable turn initiation

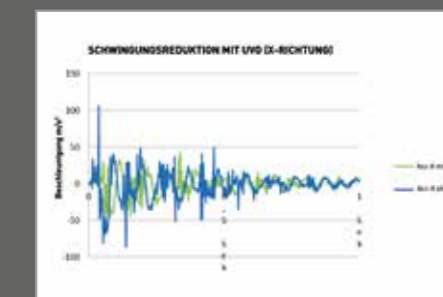
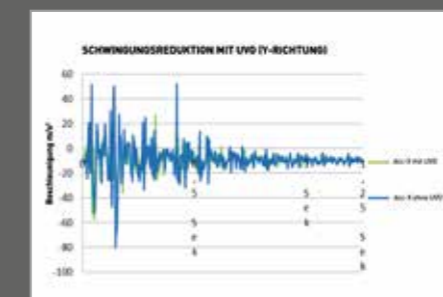
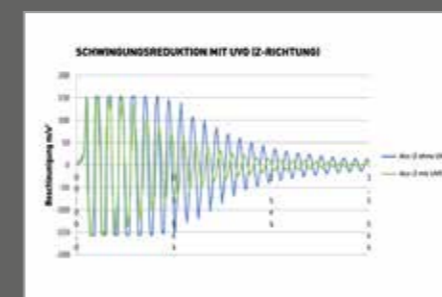
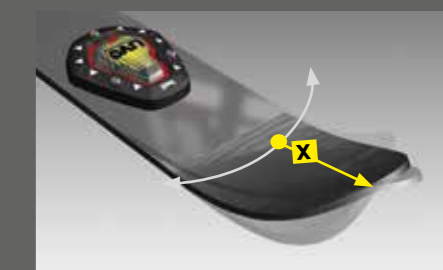

FREERIDE  
BACKCOUNTRY

12



EPF EXTENDED POWER FRAME

28% WIDER  
BETTER, PROVEN

THE NEW BINDINGS FOR FREERIDE AND  
BACKCOUNTRY

The development of the Extended Power Frame last year reflects the trend toward ever wider skis. Starting this season, the EPF construction expands beyond the Duke to include the Baron and Tour F12.

+ Extended Power Frame



This involves more than just expanding the base plate. The drill holes are also set 10 mm wider than on the previous model, which results in significantly more direct power transmission — a difference that can really be felt. The wider construction is also built around uniquely conceived heel and toe components — for ski models from 88 mm in width, the Extended Power Frame is a true revelation.

+ Drill pattern old < > new

The enlarged proportions increase stiffness and act as a power magnifier.

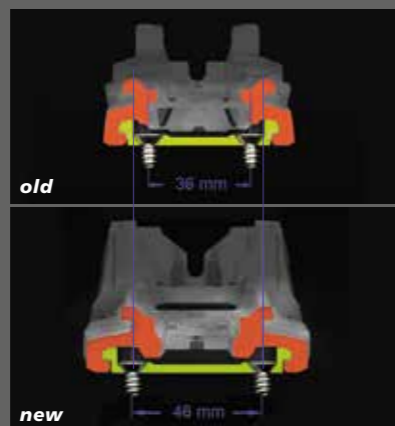

+ Hike Mechanismus



Protection rules! The Duke EPF isn't designed as a touring binding. But it provides full touring functionality, with a lever, secured under the boot. So even if you just want to hike up to the next ridge, setting the binding into walking mode requires stepping out of it. Something you would have to do anyway if skins or a crampon are required. But then on the way down, opting for a cliff or a steep couloir you can be sure your binding cannot switch back into touring mode. No other system is more reliable and therefore we keep it that way.

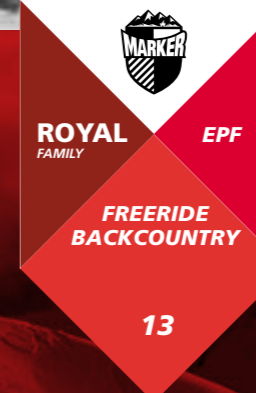

THE DUKE  
EPF



FEATURES



The freeride power packet: 28% wider than its predecessor, with toe and heel components that are specially harmonized for the EPF construction, including a compact design and greater torsional stiffness. Recommended for skis 88 mm and wider.

DIN RANGE	6.0 - 16.0
RECOM. SKIER'S WEIGHT	60 + kg
STAND HEIGHT W/O SKI	36 mm
TOE SYSTEM	Triple Pivot Elite
AFD GLIDING PLATE	stainless steel, height adjustable
STEP-IN HEEL	Inter-Pivot
EPS SYSTEM	X
COLOR COMBINATIONS	white - black - orange - petrol
WEIGHT (PAIR)	2760 g (S) / 2790 g (L)
ART. NO.	7616M1LA, 7616M1SA



THE BARON 13  
EPF



FEATURES



All the benefits of the EPF construction, now available for lighter skiers as well. The Extended Power Frame isn't the only feature that has been adopted. The new toe and heel components are also available on the Baron EPF. The 10 mm wider drilling pattern blasts the Baron into a new stratosphere of power, with a DIN setting up to 13.

DIN RANGE	4.0 - 13.0
RECOM. SKIER'S WEIGHT	<120
STAND HEIGHT W/O SKI	36 mm
TOE SYSTEM	Triple Pivot Elite
AFD GLIDING PLATE	stainless steel, height adjustable
STEP-IN HEEL	Inter-Pivot
EPS SYSTEM	X
COLOR COMBINATIONS	black - white - red
WEIGHT (PAIR)	2450 g (S), 2480 g (L)
ART. NO.	7516N1LA (L), 7516N1SA (S)

NEW



TOUR F12  
EPF



The freeride influence on touring skis can't be ignored any longer. Touring skiers have been opting for significantly wider skis, to handle the more radical terrain they've been tackling. It makes sense that MARKER's proven touring technology has now been given a corresponding wider substructure — the Tour EPF is the most powerful touring binding MARKER's ever offered. More info on the Tour F12 EPF can be found on page 15.

>> More info on page 15

NEW



ROYAL  
FAMILY

FREERIDE  
FREESTYLE

14

# FREESTYLE

NOT JUST FOR PROS



ROYAL  
FAMILY

FREERIDE  
FREESTYLE

15

## THE JESTER PRO



The ultimate weapon for professional die-hard freeriders. Comes with a team rider set up (din range up to 18 and locked AFD). A metal frame over the toe not only eliminates any form of tweaking but also lets you easily scrape snow from your boot sole.



DIN RANGE	8.0 - 18.0
RECOM. SKIER'S WEIGHT	60 + kg
STAND HEIGHT W/O SKI	22 mm
TOE SYSTEM	Triple Pivot Elite
AFD GLIDING PLATE	stainless steel, height adjustable
STEP-IN HEEL	Inter-Pivot
EPS SYSTEM	X
COLOR COMBINATIONS	mint - orange
WEIGHT (PAIR)	2048 g
ART. NO.	7924N1JT

### FEATURES



## THE JESTER



Still the first choice in terms of delivering superior skiing performance for freestylers and freeriders. The Jester features magnesium parts, no-pull-out screws and a centralized swing weight: cross-axis toe spring and compact mounting leading to a short binding, ideal for spins & twists. Recommended for skis over 76mm.



DIN RANGE	6.0 - 16.0
RECOM. SKIER'S WEIGHT	60 + kg
STAND HEIGHT W/O SKI	22 mm
TOE SYSTEM	Triple Pivot Elite
AFD GLIDING PLATE	stainless steel, height adjustable
STEP-IN HEEL	Inter-Pivot
EPS SYSTEM	X
COLOR COMBINATIONS	white - black - petrol
WEIGHT (PAIR)	1990 g (90), 2000 g (110), 2006 g (132)
ART. NO.	7924M1J+A/B/C

### FEATURES



## THE GRIFFON



The lighter version of the Jester, providing the same features for younger and lighter riders, now with new heel and toe design. The Griffon features no-pull-out screws and a centralized swing weight: cross-axis toe spring and compact mounting lead to a short binding, ideal for spins & twists. Recommended for skis over 76mm, available with 90 and 110 mm brakes. Available in 2 color combinations.



DIN RANGE	4.0 - 13.0
RECOM. SKIER'S WEIGHT	< 120 kg
STAND HEIGHT W/O SKI	22 mm
TOE SYSTEM	Triple Pivot Elite
AFD GLIDING PLATE	stainless steel, height adjustable
STEP-IN HEEL	Inter-Pivot
EPS SYSTEM	X
COLOR COMBINATIONS	black - white - petrol white - black - red
WEIGHT (PAIR)	1890 g (90mm) / 1900 g (110mm)
ART. NO.	7524N1G+A/B/C/D

### FEATURES



## THE SQUIRE



Designed for all the freestyle newcomers and lighter riders. The Triple Pivot Compact Toe and Hollow Linkage Heel make the binding very light and compact as well as sturdy. The toe height is adjustable for worn-out ski boots in order to provide optimum fit. Available in 3 color combinations.



DIN RANGE	3.0 - 11.0
RECOM. SKIER'S WEIGHT	60 - 110 kg
STAND HEIGHT W/O SKI	22 mm
TOE SYSTEM	Triple Pivot Light
AFD GLIDING PLATE	stainless steel, height adjustable
STEP-IN HEEL	Hollow linkage
EPS SYSTEM	X
COLOR COMBINATIONS	white - black white - black - green - blue white - black - yellow
WEIGHT (PAIR)	1530 g (90 mm) / 1540 g (110 mm)
ART. NO.	7424M1M+A/B/C/D/E/F

### FEATURES



NEW



**NEW**



ROYAL FAMILY

FREERIDE FREESTYLE

16

**LORD S.P.**

**THE NEW LORD S.P.**

A SKI PATROL'S DREAM - TOUR / PERFORMANCE BOOT COMPATIBLE



**+ SP Technology**

A binding for a single purpose: to meet the demands of the most respected on mountain professionals – the ski patrollers. To meet the specific demands of these unique and challenged athletes the newly designed, adjustable height toe pieces on the LORD S.P. can handle all types of ski boots, including both alpine and touring models and standards.

- >> most versatile freeride & all mountain binding
- >> compatible for both ISO standards (alpine and touring boots)
- >> magnesium heel housing
- >> high quality metal lever for easy height adjustment



1. SP Technology Touring Boot Mode



2. SP Technology Alpine Boot Mode



**LORD S.P.**



From remote couloirs, rock strewn faces, blizzard blown peaks, back bowls and crowded slopes, if you're a ski patroller, the whole mountain is your office. The Lord S.P. is designed to meet the unique and demanding requirements of this special and highly respected target group. They need to be fast into every condition, capable of reaching injured or stranded skiers and boarders regardless of conditions and locations and stable to help bring skiers safely off the mountain. The new S.P. is up to these challenges and more and easily adjusts for compatibility with both alpine ski boot standards and rubber soled touring boot standards.

DIN RANGE	5.0 - 14.0
RECOM. SKIER'S WEIGHT	< 120 kg
STAND HEIGHT W/O SKI	22 mm
TOE SYSTEM	Triple Pivot Elite
AFD GLIDING PLATE	stainless steel, height adjustable
STEP-IN HEEL	Inter-Pivot
EPS SYSTEM	X
COLOR COMBINATIONS	black - white - petrol
WEIGHT (PAIR)	2350 g (90), 2360 g (110)
ART. NO.	7629N1LN / 7629N1LW (110)

**FEATURES**



**THE JESTER SCHIZO**



ROYAL FAMILY

SCHIZO

FREERIDE FREESTYLE

17



The top model Jester Schizo comes with the same new toe and heel design as the „regular“ Jester, providing a stunning performance in every condition. All Schizo models feature MARKER's unique Multi-Stance Adjustor, offering 60 mm continuous travel for perfectly balanced riding position. And all of this on the fly.

DIN RANGE	6.0 - 16.0
RECOM. SKIER'S WEIGHT	60 + kg
STAND HEIGHT W/O SKI	25 mm
TOE SYSTEM	Triple Pivot Elite
AFD GLIDING PLATE	stainless steel
STEP-IN HEEL	Inter-Pivot
EPS SYSTEM	X
COLOR COMBINATIONS	white - black - petrol
WEIGHT (PAIR)	2466 g (90), 2472 g (110)
ART. NO.	7625M1JB

**FEATURES**



**THE GRIFFON SCHIZO**

**NEW**



The Griffon Schizo comes with the new well approved Triple Pivot Elite Toe and Inter-Pivot Heel, offering fantastic power transfer and performance wherever you go.

DIN RANGE	4.0 - 13.0
RECOM. SKIER'S WEIGHT	< 120 kg
STAND HEIGHT W/O SKI	25 mm
TOE SYSTEM	Triple Pivot Elite
AFD GLIDING PLATE	stainless steel
STEP-IN HEEL	Inter-Pivot
EPS SYSTEM	X
COLOR COMBINATIONS	black - white - petrol
WEIGHT (PAIR)	2458 g (S), 2464 g (L)
ART. NO.	7525N1GA+B

**FEATURES**



**THE SQUIRE SCHIZO**

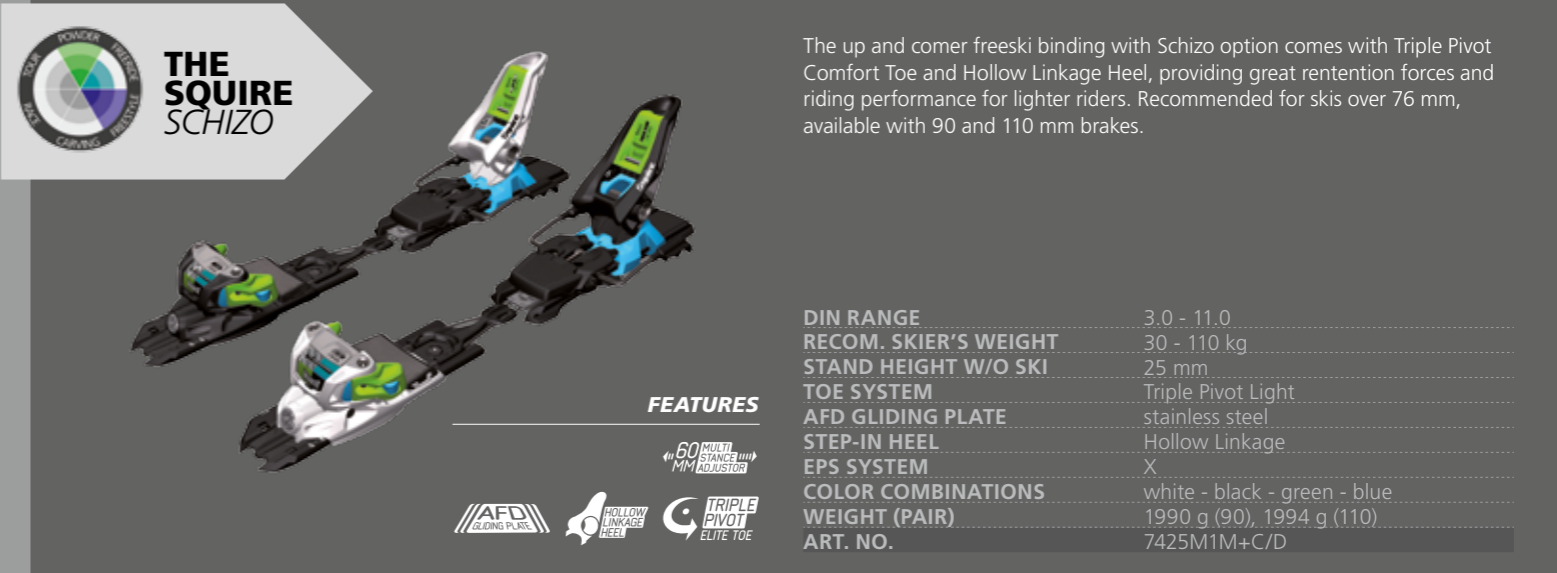

The up and comer freeski binding with Schizo option comes with Triple Pivot Comfort Toe and Hollow Linkage Heel, providing great retention forces and riding performance for lighter riders. Recommended for skis over 76 mm, available with 90 and 110 mm brakes.

DIN RANGE	3.0 - 11.0
RECOM. SKIER'S WEIGHT	30 - 110 kg
STAND HEIGHT W/O SKI	25 mm
TOE SYSTEM	Triple Pivot Light
AFD GLIDING PLATE	stainless steel
STEP-IN HEEL	Hollow Linkage
EPS SYSTEM	X
COLOR COMBINATIONS	white - black - green - blue
WEIGHT (PAIR)	1990 g (90), 1994 g (110)
ART. NO.	7425M1M+C/D

**FEATURES**





ROYAL  
FAMILY

FREERIDE  
RENTAL-DEMO

18



THE  
JESTER  
DEMO

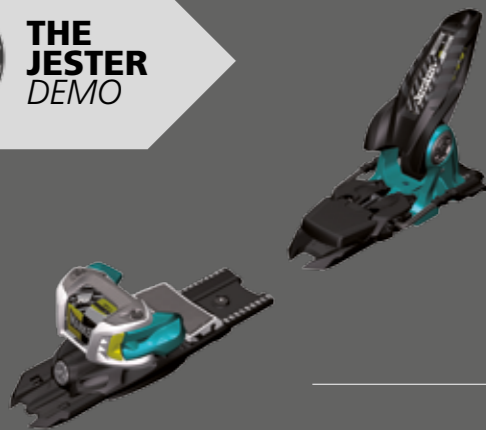

Optimized for the rental market with individually configurable toe and heel pieces, the Jester can handle the extreme demands of this growing market segment and without sacrificing ski performance by mounting a skinny rental binding

DIN RANGE	6.0 - 16.0
RECOM. SKIER'S WEIGHT	60 + kg
STAND HEIGHT W/O SKI	25 mm
TOE SYSTEM	Triple Pivot Elite
AFD GLIDING PLATE	stainless steel
STEP-IN HEEL	Inter-Pivot
EPS SYSTEM	X
COLOR COMBINATIONS	white - black - petrol
WEIGHT (PAIR)	2390 g (90), 2396 g (110)
ART. NO.	7620M1JA+B

FEATURES



THE  
GRIFFON  
DEMO

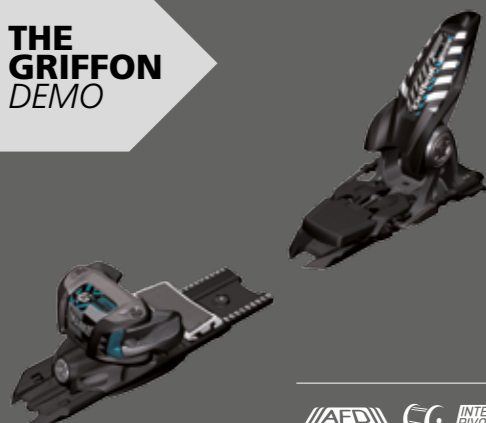

The Griffon 13 with individually adjustable toe and heel. With well approved new toe and heel design.

NEW

DIN RANGE	4.0 - 13.0
RECOM. SKIER'S WEIGHT	< 120 kg
STAND HEIGHT W/O SKI	25 mm
TOE SYSTEM	Triple Pivot Elite
AFD GLIDING PLATE	stainless steel
STEP-IN HEEL	Inter-Pivot
EPS SYSTEM	X
COLOR COMBINATIONS	black - white - petrol
WEIGHT (PAIR)	2280 g (S), 2286 g (L)
ART. NO.	7520N1GA+B

FEATURES



THE  
SQUIRE  
DEMO

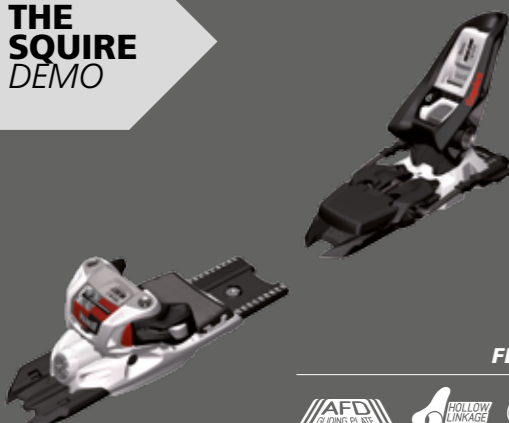

The perfect binding with individually adjustable toe and heel for the young and aspiring light-weight freeskiers.

DIN RANGE	3.0 - 11.0
RECOM. SKIER'S WEIGHT	30 - 110 kg
STAND HEIGHT W/O SKI	25 mm
TOE SYSTEM	Triple Pivot Light
AFD GLIDING PLATE	stainless steel
STEP-IN HEEL	Hollow Linkage
EPS SYSTEM	X
COLOR COMBINATIONS	white - black
WEIGHT (PAIR)	1990 g (90), 1994 g (110)
ART. NO.	7420M1M+A/B

FEATURES



CLASSIC  
FREE

19

# JUNIOR FREERIDE ENTRY



FREE  
TEN



The ideal choice for all freeride and freestyle starters, coming in a royal design and with a freeride brake designed for the application.

DIN RANGE	3.0 - 10.0
RECOM. SKIER'S WEIGHT	30 - 110 kg
STAND HEIGHT W/O SKI	23 mm
TOE SYSTEM	Triple Pivot light
AFD GLIDING PLATE	Gliding AFD
STEP-IN HEEL	Compact
EPS SYSTEM	X
COLOR COMBINATIONS	white - black - red
WEIGHT (PAIR)	1434 g, 1440 g
ART. NO.	7224M1MA, 7224M1MB

FEATURES



M 7.0  
FREE



For all the junior stylers we recommend the M 7.0 Free with EPS, AFD gliding plate, Quick Adjust Compact heel and Biotech system.

DIN RANGE	2.0 - 7.0
RECOM. SKIER'S WEIGHT	24 - 75 kg
STAND HEIGHT W/O SKI	18 mm
TOE SYSTEM	Biotech 4-linkage
AFD GLIDING PLATE	Active AFD
STEP-IN HEEL	FT Kids
EPS SYSTEM	X
COLOR COMBINATIONS	black - green - blue
WEIGHT (PAIR)	1280 g
ART. NO.	6220N1MF

FEATURES



# TOURING 13/14

INTRODUCING THE EPF TECHNOLOGY



Touring bindings have to be as light as possible to make the ascent more comfortable. They also have to be as durable as possible to live up to modern performance expectations - top skiing performance in any situation. We make the impossible possible.

## UPHILL FEATURES



### + Balance

Switching the lever to touring mode moves the whole binding 40 mm backward, allowing a more comfortable walking position and keeping the ski optimally balanced for kick turns and steep terrain.



### + Pivot Plate

Bearing bushings ensure smooth operation and eliminates fore/aft play. A hollow stainless steel pivot provides higher stability without adding weight. Additional Teflon® coating at the bottom reduces snow adhesion.



### + AFD System

A rubber sleeve around the AFD screw eliminates eventual sticking of snow or ice. An additional Teflon® coating at the bottom further reduces ice adhesion.



### + Climbing Aid

The titanium climbing aid offers two positions with 7° and 13° which can easily be accessed with the ski pole.



### + Crampon

Tailor-made and super light anodized aluminium crampon for the F10 and F12 bindings are available in 82, 92, 113 and 128 mm widths. The mounting position is right under the arch in order to provide maximum pressure and do ease hiking.



### + Touring brake

The 85 mm brake for the F10 can easily be removed – even by the end user. Just remove the two fixation screws, slide off the brake, remove the brake arm, and re-install the heel spacer. The wide platform for the boot provides power transmission. Standard safety straps available on the market are adaptable to the F10 and F12 Tour models.

## DOWNHILL FEATURES

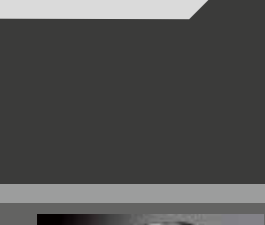

### + EPF Technology (Tour F12 EPF)

The new frame allows a significant enlargement of the screw pattern. Compared to the previous model the screws are placed 28% further towards the outside. Therefore the momentum transfer is much closer to the edges, placed exactly where the power is needed. As a result, the performance of wider skis is remarkably improved.



### + Triple Pivot Light Toe

A subtle material increase provides higher stability. Teflon® gliding shoes reduce wear and further improve power transmission.



### + Touring Base Plate

Made with polyamide, making it even stiffer and more robust than before. The modified profile makes changing to ski mode easier and improves handling in snowy or icy conditions.

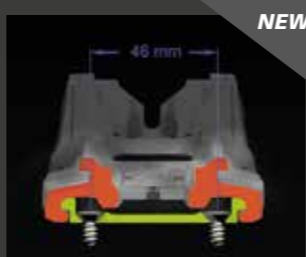

### + Hollow Linkage Heel

Improved heel kinematics enable a smoother stepping in.



### + Carbon Plate

25% more robust due to increased dimensions.

TOURING  
21

## FREERIDE TOUR



### TOUR F12 EPF



#### FEATURES



**NEW**  
The next logical step for the touring collection. All proven features of the Tour F12 combined with the power of the EPF frame. This keeps even the widest touring ski manageable whatever the terrain. The improved power transfer provides control through curves and steeps in all snow conditions.

DIN RANGE	4.0 - 12.0
RECOM. SKIER'S WEIGHT	< 120 kg
STAND HEIGHT W/O SKI	36 mm
TOE SYSTEM	Triple Pivot Light
AFD GLIDING PLATE	stainless steel, height adjustable
STEP-IN HEEL	Hollow Linkage
EPS SYSTEM	X
COLOR COMBINATIONS	black - white - green white - black - blue
WEIGHT (PIECE)*	1075 g (S), 1090 g (L)
ART. NO.	7816N1SE+SB, 7816N1LE+LB

\* WITH BRAKE AND SREWS

## CLASSIC TOUR



### TOUR F12



#### FEATURES



The heavy-duty touring binding, technically similar to the F10 but with more brawn. Roughly 60 grams heavier than its lighter sibling the higher DIN range calls for fast turns and steep runs and those who need that bit of extra power for tougher terrain.

DIN RANGE	4.0 - 12.0
RECOM. SKIER'S WEIGHT	< 120 kg
STAND HEIGHT W/O SKI	36 mm
TOE SYSTEM	Triple Pivot light
AFD GLIDING PLATE	height adjustable
STEP-IN HEEL	Hollow Linkage
EPS SYSTEM	X
COLOR COMBINATIONS	black - white - red
WEIGHT (PIECE)*	1020 g (S), 1040 g (L)
ART. NO.	7816M1TA, 7816M1TB



### TOUR F10



#### FEATURES



The perfect choice for the touring skier who doesn't accept any compromise when it comes to weight, handling and reliability. Designed for the skier looking forward to the descent as much as the ascent and a general focus on light weight.

DIN RANGE	3.0 - 10.0
RECOM. SKIER'S WEIGHT	30-105 kg
STAND HEIGHT W/O SKI	36 mm
TOE SYSTEM	Triple Pivot light
AFD GLIDING PLATE	height adjustable
STEP-IN HEEL	Hollow Linkage
EPS SYSTEM	X
COLOR COMBINATIONS	black - white - red
WEIGHT (PIECE)*	950 g (85) S, 980 g (90) S 970 g (85) L, 999 g (90) L
ART. NO.	7716M1T+A, C (S) / 7716M1T+B, D (L)

# PERFORMANCE SKIING



## 12.0 GLIDE CONTROL D-SYSTEM



### FEATURES



Only 2260 g light and built to carve! Equipped with the D-System, offering perfect power transmission and edge grip due to a wider stance on a sole length from 262 - 374 mm. The D-System features a lever single operation for fast mounting and fast precise adjustment.

DIN RANGE	4.0 - 12.0
RECOM. SKIER'S WEIGHT	<120 kg
STAND HEIGHT W/O SKI	28 mm
TOE SYSTEM	Triple Pivot Comfort
AFD GLIDING PLATE	stainless steel
STEP-IN HEEL	Twin Cam
EPS SYSTEM	X
COLOR COMBINATIONS	white - black
WEIGHT (PAIR)	2266 g (110), 2262 g (90)
ART. NO.	6826L1M+A/B

# KIDS



## 11.0 GLIDE CONTROL D-SYSTEM

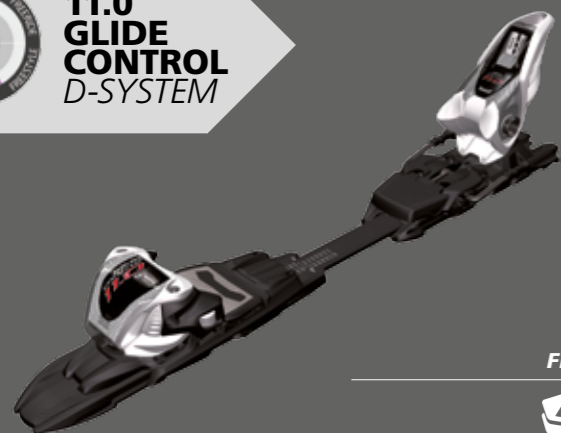

### FEATURES



Only 1920 g light! Apart from that the 11.0 comes with the exact same features as the 12.0, but with Din setting adjusted for lighter riders and a Compact heel.

DIN RANGE	3.0 - 11.0
RECOM. SKIER'S WEIGHT	30-110 kg
STAND HEIGHT W/O SKI	28 mm
TOE SYSTEM	Triple Pivot Compact
AFD GLIDING PLATE	stainless steel
STEP-IN HEEL	Compact
EPS SYSTEM	X
COLOR COMBINATIONS	white - black
WEIGHT (PAIR)	1920 g
ART. NO.	6626L1MB



## M 7.0 EPS



### FEATURES

Comes with EPS and active AFD gliding plate as well as with Quick Adjust Compact heel and the Biotech system.

DIN RANGE	2.0 - 7.0
RECOM. SKIER'S WEIGHT	24-75 kg
STAND HEIGHT W/O SKI	18 mm
TOE SYSTEM	VB Kids - 4 linkage
AFD GLIDING PLATE	Active AFD
STEP-IN HEEL	Kids quick heel
EPS SYSTEM	X
COLOR COMBINATIONS	white - black / white - anthracite - blue
WEIGHT (PAIR)	1280 g
ART. NO.	6220M1W+S/B



## 10.0 EPS



### FEATURES

Completely re-designed toe and heel, delivering a stunning performance for the young and light-weight carving novices.

DIN RANGE	2.5 - 10.0
RECOM. SKIER'S WEIGHT	30-105 kg
STAND HEIGHT W/O SKI	22 mm
TOE SYSTEM	2 linkage
AFD GLIDING PLATE	Gliding AFD
STEP-IN HEEL	Compact
EPS SYSTEM	X
COLOR COMBINATIONS	white - black
WEIGHT (PAIR)	1499 g
ART. NO.	6520N1VA



## M 4.5 EPS



### FEATURES

Built on the same platform as the 7.0 and with active AFD gliding plate, Quick Adjust Compact heel and the Biotech system, and tailor-made for the youngster.

DIN RANGE	0.75 - 4.5
RECOM. SKIER'S WEIGHT	12 - 57 kg
STAND HEIGHT W/O SKI	18 mm
TOE SYSTEM	VB Kids - 4 linkage
AFD GLIDING PLATE	Active AFD
STEP-IN HEEL	Kids quick heel
EPS SYSTEM	X
COLOR COMBINATIONS	white - black <sup>1</sup> / white - anthracite - blue <sup>2</sup>
WEIGHT (PAIR)	1280 g
ART. NO.	6120M1W+S/B <sup>2</sup> /W <sup>1</sup> (85mm)

# RENTAL



## THE FASTRAK III



One of the lightest rental binding in its class, with new colors in 13-14! Featuring a newly designed (12-13) toe and heel and a fast and easy to access fully synchronized demo system, mounted on a brand new premountable base plate.

DIN RANGE	2.5 - 10
RECOM. SKIER'S WEIGHT	30 - 105 kg
STAND HEIGHT W/O SKI	35 mm
TOE SYSTEM	Two Linkage
AFD GLIDING PLATE	Gliding AFD
STEP-IN HEEL	Compact 2
EPS SYSTEM	X
COLOR COMBINATIONS	black - white - silver
WEIGHT (PAIR)	2316 g
ART. NO.	6523N1MS 6523N1SS (System)

**FEATURES**



## THE FASTRAK II JUNIOR



**Sole length 245 - 330 mm (4.5) | 245 - 330 mm (7.0)**

Developed for the younger riders, the M 4.5 and M 7.0 Fastrak II systems offer the perfect solution for rental and ski schools. The sole lengths are tied to the specific DIN ranges of each binding. Easy to operate, easy to secure!

	M 7.0	M 4.5
DIN RANGE	2 - 7	0.75 - 4.5
RECOM. SKIER'S WEIGHT	24 - 75 kg	12 - 57 kg
STAND HEIGHT W/O SKI	25 mm	25 mm
TOE SYSTEM	VB.Kids - 4 linkage	VB.Kids - 4 linkage
AFD GLIDING PLATE	Active AFD	Active AFD
STEP-IN HEEL	Kids Quick Heel	Kids Quick Heel
EPS SYSTEM	X	X
COLOR COMBINATIONS	white - black	white - black
WEIGHT (PAIR)	1400 g / 1474 g (85 mm)	1468 g
ART. NO.	6223M1LR (System) 6223M1LC	6123M1SR (System) 6123M1SC

**FEATURES**



## JUNIOR RTL



Especially the younger clients want to ski, not wait. MARKER's Junior RTL series is the ideal choice for fast and convenient mounting and adjusting needs, perfectly suited for the lighter weight skier. And they're the lightest junior rental bindings on the market.

	M 7.0 RTL	M 4.5 RTL
DIN RANGE	2 - 7	0.75 - 4.5
RECOM. SKIER'S WEIGHT	24 - 75 kg	12 - 57 kg
STAND HEIGHT W/O SKI	18 mm	18 mm
TOE SYSTEM	VB.Kids - 4 linkage	VB.Kids - 4 linkage
AFD GLIDING PLATE	Active AFD	Active AFD
STEP-IN HEEL	Kids Quick Heel	Kids Quick Heel
EPS SYSTEM	X	X
COLOR COMBINATIONS	white - black	white - black
WEIGHT (PAIR)	1340 g / 1360 g (85 mm)	1340 g
ART. NO.	6220M1MR 6220M1MW (85 mm)	6120M1MR

**FEATURES**



# ACCESSOIRES

Be it Racing, Freeriding or Touring - useful additions complement your sales and enlarge the area of use. MARKER accessories provide exactly what you need.



**Freeride Brake**  
Works with all Royal Family and MARKER Touring bindings.  
Art. No. W017G1B (90 mm)  
W016G1B (110 mm)  
W015G1B (132 mm)



**Standard Brake**  
The standard brake, 16.0 - M 9.0  
Art. No. W009F1B (90 mm)  
W005F1B (110 mm)



**Junior Brake**  
Suited for skis up to 85 mm  
Art. No. W005L1B



**Touring Crampon**  
Tailor-made and super light anodized aluminium crampon for the F10 and F12 bindings as well as the Duke and Baron, available in 82, 92, 113 and 128 mm widths. Contrary to other systems the mounting position on the Tour bindings is right under the arch in order to provide maximum pressure and to ease hiking due to an optimal crampon position.  
Art. No. H003K1A (82 mm), H001M1A (92 mm)  
H002M1A (113 mm), H004M1A (128 mm)



**Touring Skins**  
200 cm long, 13 cm wide, self-adhesive and customizable for every touring or freeride ski. Material: Mohair mix  
Art. No. 158703



**2541**  
Gauge drill Ø 8 mm (adjustable depth)



**2544**  
Screw driver Pozidrive # 3



**2547**  
Power bit 150 mm fine (Pozidrive)



**2552**  
Binding drill bit 4.1 x 9.5



**2565**  
Allen key, ball end # 5



**2637**  
Binding drill bit 3.6 x 7.5



**2639**  
Binding drill bit 3.6 x 9.5



**2653**  
Trap-In insert PA 6 (100 pcs.)



**2660**  
Binding glue



**2661**  
Screw driver slotted # 5.5



**UTILITIES**  
The little helpers that make your life so much easier...

**2662**  
MARKER silicone spray 300 ml

**INSTALLATION TOOLS**



W006M1T Installation Tool Duke EPF S + L 95 - 150 mm



W001G1T Installation Tool 16.0 - M 9.0, Jester, Griffon, Schizo, Squire; 61 - 117 mm  
W012J1T Installation Tool 16.0 - M 9.0, Jester, Griffon, Schizo, Squire; 95 - 150 mm



W010G1T Installation Tool Tour, Duke, Baron; S & L, Tour; S & L 61 - 117 mm  
W011J1T Installation Tool Tour, Duke, Baron; S & L, Tour; S & L 95 - 150 mm



W002H1T Installation Tool PC - WC (50 mm); Jr. R Plate; 61 - 117 mm



W003H1T Installation Tool Fastrak II + Jr.; 61 - 117 mm



W007H1T Installation Tool M 7.0, M 4.5 + Jr. RTL



W001J1A Mounting Tool Adapter Wide Skis 148 mm (not shown)



W005L1T Glide, Royal Demo, etc. (not shown)

ROYAL FAMILY - FREERIDING

 +NEW Duke EPF S 110 mm - 7616M1SA	 Baron EPF S 110 mm - 7516N1SA		 Jester 110 mm - 7624M1JB Jester 132 mm - 7624M1JC	 +NEW Griffon 110 mm - 7524N1GB Griffon 90 mm - 7524N1GC Griffon 110 mm - 7524N1GD
--	-----------------------------------	--	--	--

 +NEW Marker Lord S.P. 110 mm - 7629N1LW	 Squire 11 90 mm - 7424M1.MC/Squire 11 110 mm - 7424M1MD Squire 11 90 mm - 7424M1.ME/Squire 11 110 mm - 7424M1MF		 +NEW Griffon Schizo 110 mm - 7525N1GB	 Squire Schizo 110 mm - 7425M1MD
--	--	--	--	-------------------------------------

FREE

 Free Ten 100 mm - 7224M1MB	
--------------------------------	--

TOUR

 +NEW F 12 TOUR EPF L 110 mm - 7816N1LE F 12 TOUR EPF S 110 mm - 7816N1SB F 12 TOUR EPF L 110 mm - 7816N1LB	 F12 TOUR L 90 mm - 7816M1TB	 F10 TOUR L 85 mm - 7716M1TB F10 TOUR S 90 mm - 7716M1TC F10 TOUR L 90 mm - 7716M1TD
---	---------------------------------	---

COMPETITION

	 +NEW	 +NEW		
--	----------	----------	--	--

INTERFACE

 +NEW World Cup PC Interface GS / SL Bulk - 2020N1MC World Cup PC Interface 14 mm - 2022N1WS World Cup PC Interface 14 mm Bulk - 2022N1WB	 +NEW	
---	----------	--

PERFORMANCE

 +NEW 12.0 Glide Control D System 90 mm - 6826L1MB			 M 7.0 EPS - 6220M1WB	 M 4.5 EPS - 6120M1WB M 4.5 EPS - 6120M1WW 85mm
--	--	--	--------------------------	---

JUNIOR

RENTAL

 +NEW 10.0 Fastrak III - 6523N1MS	 M 7.0 Fastrak II System L 85mm - 6223M1LB M 7.0 Fastrak II L - 6223M1LC M 7.0 Fastrak II L 85 mm - 6223M1LW	 M 4.5 Fastrak II System S 85mm - 6123M1SB M 4.5 Fastrak II S - 6123M1SC	 M 7.0 RTL 85 mm - 6220M1MW	
---	---	--	--------------------------------	--

ROYAL FAMILY RENTAL

 +NEW Jester Demo 110 mm - 7620M1JB	 Griffon Demo 110 mm - 7520N1GB	 Squire Demo 110 mm - 7420M1MB
---	------------------------------------	-----------------------------------

INTERNATIONAL HEADQUARTER

**MARKER DEUTSCHLAND GMBH**  
Dr. Gotthilf-Näher-Strasse 6  
82377 Penzberg  
Germany  
Ph: +49 (0) 8856 8000-0  
Fax: +49 (0) 8856 8000-271  
info@marker.de

Photography: Helge Kirchberger, Klaus Polzer, Alex O'Brien, Chris McLennan, Peter Mathis, GEPA, Michael Mayer, Pally Learmond, Erlend Haugen, Dan Milner  
created & produced by: yearning.de

Marker, Piston Control, Glide, Fastrak, EPS, Duke, Jester, Baron, Griffon, Squire, Schizo, Ampire, Lord, i-roc and Biotech are registered Marker trademarks and other marks are pending. Subject to alteration.

ACCESSOIRES

 +NEW Freeride Brake 110 mm - W016G1B Duke/Jester/Tour wide brake 132 mm - W015G1B	 Standard Brake 110 mm - W005F1B		 Touring Crampon 92 mm - H001M1A Touring Crampon 113 mm - H002N1A Touring Crampon 128 mm - H004M1A	
---	-------------------------------------	--	---	--

OUR PARTNERS

Being able to work closely together with some of the world's biggest and well-renowned ski companies allows us not only to develop our own top level binding components but also to design factory systems, perfectly matched to the individual skis. This long-year relationship has helped us all to make skiing safer, faster, more competitive and more fun season after season.



VISIT US

YOUTUBE.COM/MARKERBINDINGS  
FACEBOOK.COM/MARKERSKIBINDINGS  
TWITTER.DE  
WWW.MARKER.NET