

OKOVJE ZA DRSNÁ VRATA



Sevroll PAX



 **SEVROLL**
GEMINI PAX
okvir

Pax sistem drsnih vrat za lahkotno in elegantno pohištvo.

Zaradi uporabe minimalističnih profilov Pax sistem omogoča skoraj neomejene možnosti oblikovanja. Kljub minimalističnem izgledu, konstrukcija okvirja Pax zagotavlja izjemno trdnost in togost tudi pri večjih dimenzijah vrat. Sistem omogoča uporabo različnih barv stekla in ostalih materialov.

Prednosti sistema Pax

- Neviden okvir in ročaj
- Neviden drsni sistem Gemini, nosilnosti do 50kg (koleščka vgrajena v profil)
- Možnost kombinacij različnih barv stekla brez vidnih veznih elementov
- Možnost blaženja – soft close sistem za mirno in neslišno zapiranje vrat
- Možnost uporabe različnih materialov debeline 4mm: zrcalo, steklo, lesna polnila, ...
- Sistem je dobavljiv v dveh barvah, srebrna in bela (bela barva po naročilu)
- Max. višina vrat do 2700mm
- Max. širina vrat do 1100mm

konstrukcija	sistem vodil	polnilo	nosilnost	maksimalna dolžina ročaja	maksimalna dolžina vodila
STEKLO	kolesa z ležajem	ogledalo ali steklo 4 ali 4,5mm	50 KG	2,7 m	4,05 m

Sevroll PAX



Artikel	Koda dobavitelja	Naziv	EM
PAXR27S	4094	Ročaj Pax, srebrni l=2,7m	kos

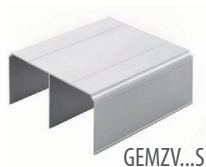
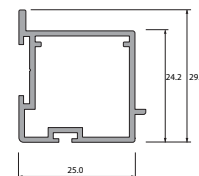

Artikel	Koda dobavitelja	Naziv	EM
GEMZV23S	01025	Zgornje vodilo GEMINI, 2,35m, srebrni	kos
GEMZV30S	01026	Zgornje vodilo GEMINI, 3,00m, srebrni	kos
GEMZV40S	01469	Zgornje vodilo GEMINI, 4,05m, srebrni	kos
GEMSV23S	01278	Spodnje vodilo Gemini, srebrni, l=2,35 m	kos
GEMSV30S	01279	Spodnje vodilo Gemini, srebrni, l=3,00 m	kos
GEMSV40S	01470	Spodnje vodilo Gemini, srebrni, l=4,05 m	kos

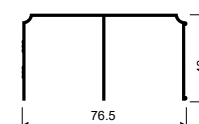

Artikel	Koda dobavitelja	Naziv	EM
PAXSP3M	4095	Spodnji profil Pax srebrni l=3m	kos
PAXZG3M	4096	Zgornji profil Pax srebrni l=3m	kos

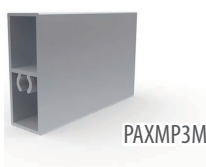
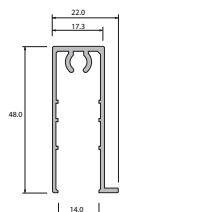

Artikel	Koda dobavitelja	Naziv	EM
PAXMP3M	4161	Pax montažni profil l=3m	kos

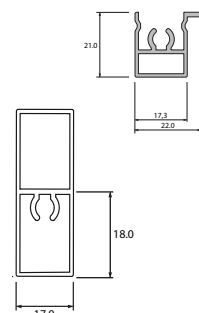

Artikel	Koda dobavitelja	Naziv	EM
SVRSCCENT	20319-SV	Sevroll Soft close CENTRALNI 40kg, komplet za ena vrata	kpl
SVRSCMINI	20258-SV	Sevroll Soft close MINI 40kg, komplet za dvojna vrata	kpl



Sevroll PAX

PAXKOLZG



SVRSTHT



SIBV632



PAXZAK

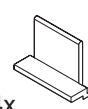

PAXRTR



PAXKOLSP



Artikel	Koda dobavitelja	Naziv	EM
PAXZAK	20298	Pax zaključni pokrov 4kos/kpl	kpl
PAXRTR	20327	Pax transparentni plastični ročaj	kos
PAXKOLSP	10051-sv-g	Pax koleščka spodnja	kpl
PAXKOLZG	10049-sv-g	Pax koleščka zgornja	kpl
SVRSTHT	20080	Sevroll štoper HI TEC	kos
SIBV632	20001	Sevroll vijak 6x32	kos

PAXKOLSP



Sevroll okovje za drsna vrata

Sevroll PAX

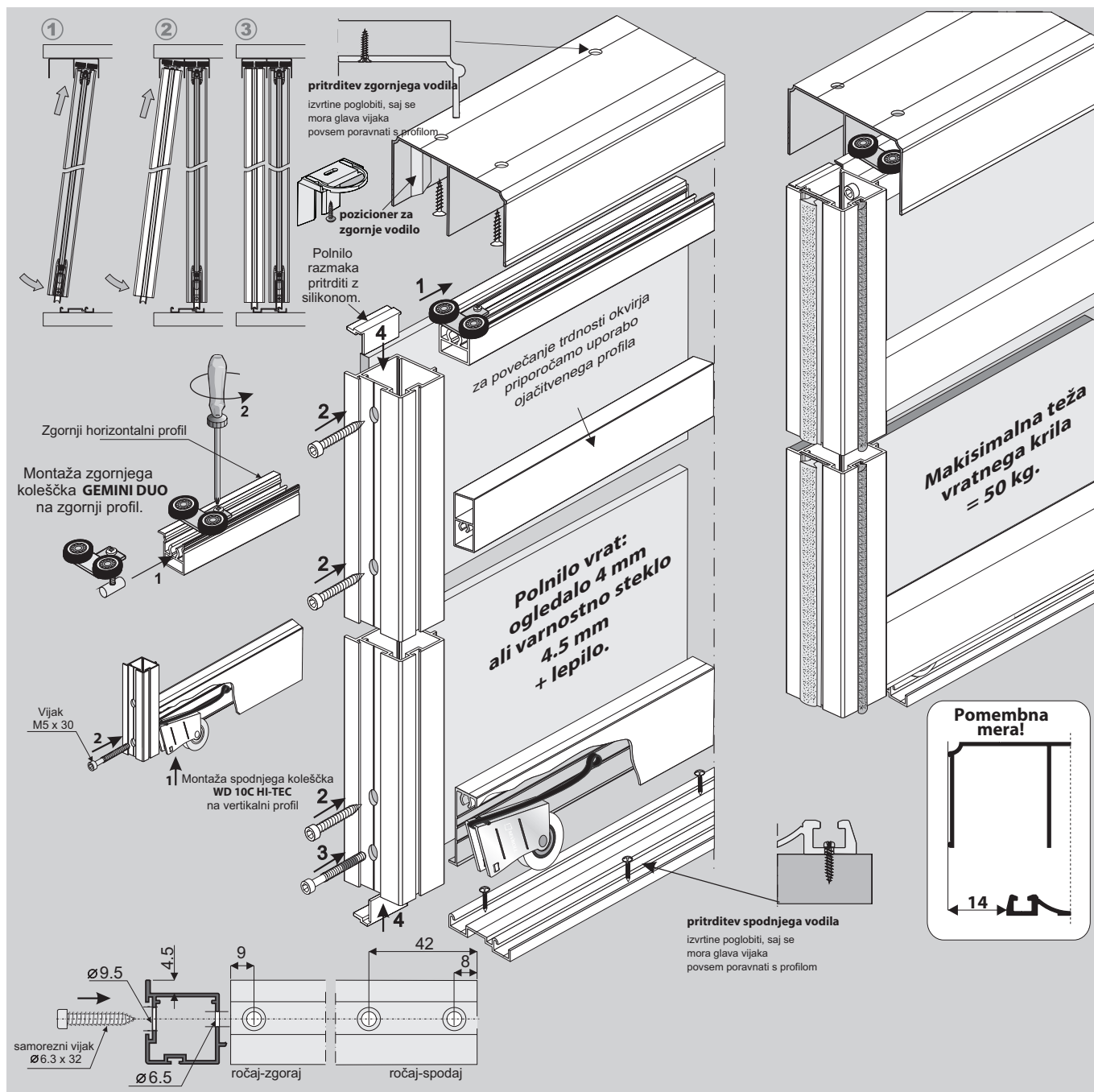

SESTAVNI DELI

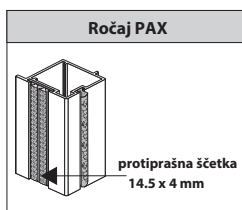

Dolžina: 2.7 m

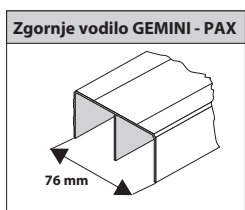

Dolžina: 4.05 m

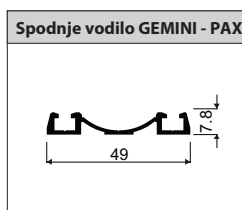

Dolžina: 4.05 m

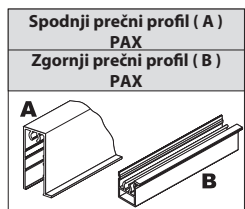
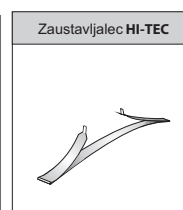
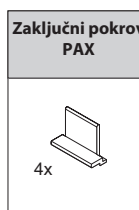

Dolžina: 3.0 m

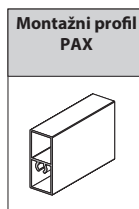

Dolžina: 3.0 m

Ne pozabite!
Potrebujete samorezne vijake,
prodajajo se ločeno (4 vijaki za ena v



svetla mera

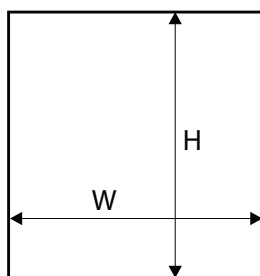

polnilo vrat :

- ogledalo ali steklo 4 mm

dolžina ročaja = višina vrat

višina vrat brez blaženja	h	$h = H - 38 \text{ mm}$	
višina vrat z blaženjem	Mini SV40	$h = H - 42 \text{ mm}$	
	CENTRAL	$h = H - 42 \text{ mm}$	
višina ogledala	hm	$hm = h - 4 \text{ mm}$	
širina vrat	W	$w = (W - 3 + Z) : N$	
širina ogledala	wm	$wm = w - 4 \text{ mm}$	
dolžina spodnjega PAX profila	L	$L = U = w - 50 \text{ mm}$	
dolžina zgornjega PAX profila	U		

število vrat	N	2	3
prekrivanje	Z	25 mm	50 mm

način prekrivanja - 4 krila

	$w = (W + 72) : 4$
	$w = (W : 2 + 22) : 2$

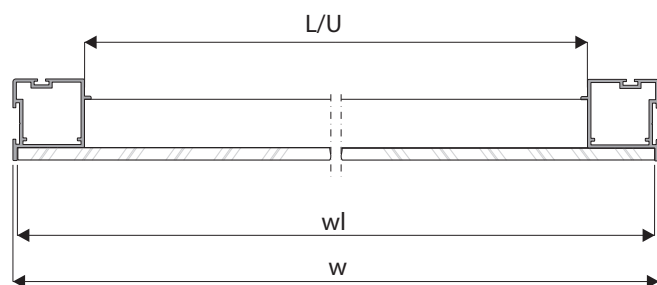

način montaže ogledala ali 4 mm stekla

- z ročajem

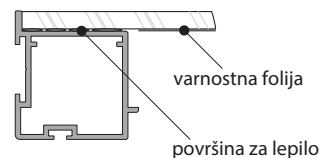

- z zgornjim prof ilom

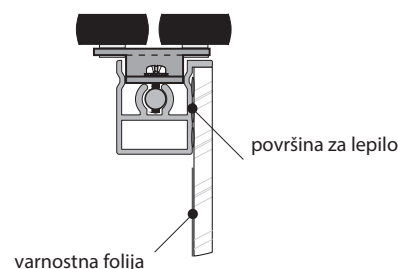

- z spodnjim profilom

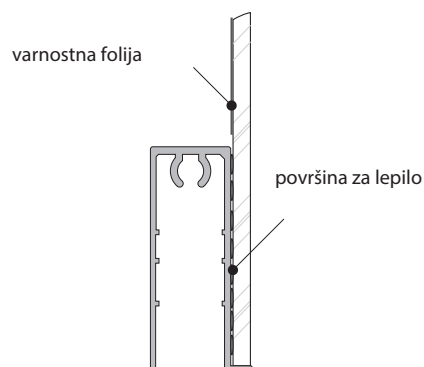

priporočeno je da steklo ali ogledalo lepitate na aluminij z namenskim lepilom za lepljenje stekla

POZOR!

Ob uporabi ogledala 4mm je obvezna uporaba varnostne folije. Varnostno steklo (4,5mm) je sestavljeno iz dveh tankih plasti stekla in folije.

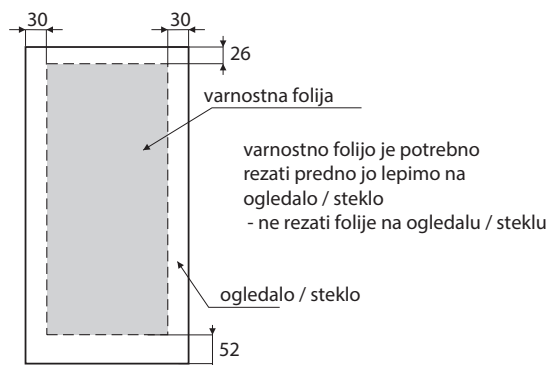

POZOR!

Odstranite zaščitno folijo iz ALU elementov (ročaji, vodila, profili,...) predno jih režete na željeno mero. Napake v kvaliteti (primer : praske) bodo vidne po odstranjeni zaščitni foliji.



Sistem drsnih vrat MAXIM.

Sistem MAXIM okvir je sistem, ki omogoča tako uporabo stekla 4 mm in plošče 18 mm, kot tudi kombinacijo obeh. Z uporabo tesnila onemogočimo stik stekla z aluminijem ter tako zmanjšamo možnost poškodbe le tega.

Prednosti sistema MAXIM

- Možnost uporabe kot prehodna vrata - saj je na obeh straneh videz enak (Ročaj Prosper in simetrično tesnilo)
- Nosilnosti do 50kg (koleščka vgrajena v profil)
- Možnost kombinacij različnih barv stekla s pomočjo tesnila
- Možnost blaženja – soft close sistem za mirno in neslišno zapiranje vrat
- Možnost uporabe različnih materialov debeline 18mm in 4mm: zrcalo, steklo, lesna polnila, ...
- Max. višina vrat do 2700mm

konstrukcija	sistem vodil	polnilo	nosilnost	maksimalna dolžina ročaja	maksimalna dolžina vodila
OKVIR	kolesa z ležajem	18mm in 4mm	50 KG	2,7 m	3,5 m

Sevroll MAXIM II okvir



Artikel	Koda dobavitelja	Naziv	EM
MAXPRS27S	03145	Ročaj Prosper II, sistem MAXIM II, srebrni l=2,7m	kos

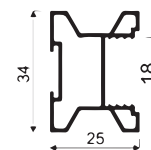

Artikel	Koda dobavitelja	Naziv	EM
MAXIIZV25S	02024	Zgornje vodilo MAXIM II, 2,5m, srebrni	kos
MAXIIZV35S	02298	Zgornje vodilo MAXIM II, 3,5m, srebrno	kos
MAXIISV25S	02806	Spodnje vodilo MAXIM II, 2,5m, srebrni	kos
MAXIISV35S	02808	Spodnje vodilo MAXIM II, 3,5m, srebrni	kos
MAXIIPSV25	02813	Pokrov spodnjega vodila, srebrna, 2,5m	kos
MAXIIPSV35	02815	Pokrov spodnjega vodila, srebrna, 3,5m	kos

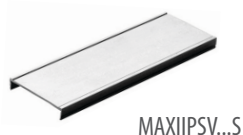
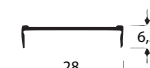
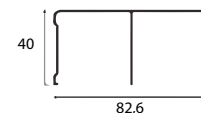

Artikel	Koda dobavitelja	Naziv	EM
MAXIISP25S	02809	Sevroll spodnji profil MAXIM II, 2,5m, srebrni	kos
MAXIISP35S	02811	Sevroll spodnji profil MAXIM II, 3,5m, srebrni	kos
MAXIIZP25S	02022	Sevroll zgornji profil MAXIM II, 2,5m, srebrni	kos
MAXIIZP35S	02301	Sevroll zgornji profil MAXIM II, 3,5m, srebrni	kos
MAXIIMP25S	01882	Sevroll MAXIM II montažni profil l=2,5m	kos

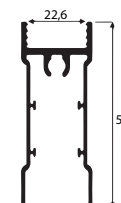
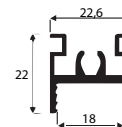
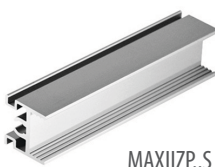
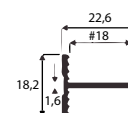

Artikel	Koda dobavitelja	Naziv	EM
SVRSCCENT	20319-SV	Sevroll Soft close CENTRALNI 40kg, komplet za ena vrata	kpl
SVRSCMINI	20258-SV	Sevroll Soft close MINI 40kg, komplet za dvojna vrata	kpl
MAXIITES4NS	20106	Tesnilo za MAXIM II, 18>4, nesimetrično	TM
MAXIITES4S	20102	Tesnilo za MAXIM II, 18>4, simetrična	TM



Sevroll MAXIM II Okvir



Artikel	Koda dobavitelja	Naziv	EM
MAXIISSET2	02066	SEVROLL MAXIM II SET M18-2 za dvojna vrata	kpl
MAXIISSET3	02067	SEVROLL MAXIM II SET M25-3 za trojna vrata	kpl

Sevroll okovje za drsna vrata

Sevroll PROSPER okvir

1 **2** **3**

pritrnitev zgornjega vodila
izvrtno poglobiti, saj se mora glava vijaka povsem poravnati s profilom

pozicioner za zgornje vodilo

Pomembna mera!
16

montaža zgornjega kolesčka v zgornji simple OKVIR profil

ogledalo ali varnostno steklo + tesnilo kot distančnik za steklo

Maksimalna teža krila vrat = 50 KG

Polnilo vrat 18mm

montaža spodnjega kolesčka na spodnji simple OKVIR profil

vijak M 5 x 30

pritrnitev spodnjega profila
izvrtno fi 3 mm ni potrebno poglobiti

45

8 12

ročaj - zgoraj ročaj - spodaj

Ø 9.5
samorezni vijak Ø 6.3 x 32
Ø 6.5

POZOR:
Za hitro in natančno vrtanje lukenj, vam priporočamo, da uprabite našo simple šablono

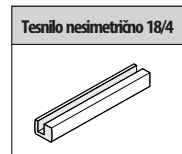
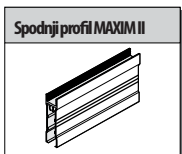
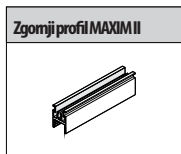
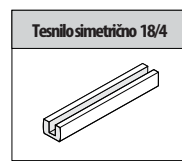
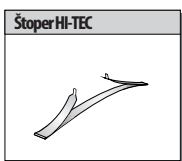
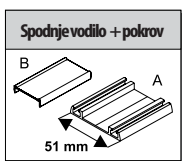
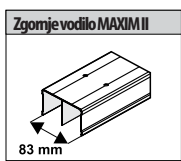
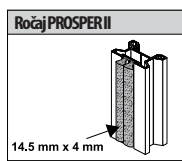

SESTAVNI DELI

Način montaže polnila 18 mm (skica A).

Način montaže ogledala ali 4 mm stekla (skica B).

Svetla mera

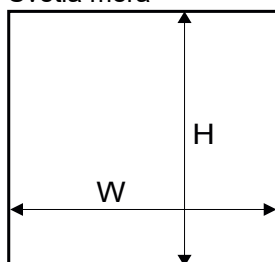

polnilo vrat
plošča # 18 mm
ogledalo # 4 mm ali steklo



- z ročajem

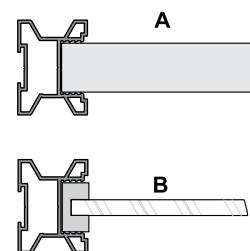

- z zgornjim profilom

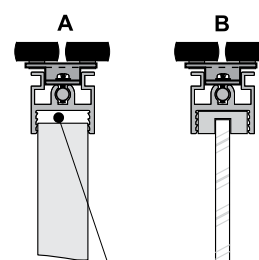

Konstruktivski razmak je upoštevan pri kalkulaciji višine vrat.

- z spodnjim profilom

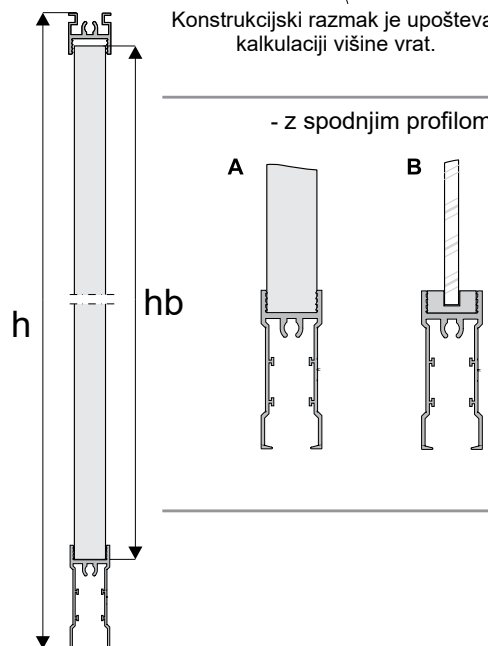

polnilo vrat # 18 mm plošča	
-----------------------------	--

višina vrat brez blaženja - h	h = H - 38 mm	
višina krila vrat z blaženjem	Mini SV40	h = H - 38 mm
	Central	h = H - 40 mm
višina plošče - hb	hb = h - 68 mm	
širina vrat - w	w = (W - 3 mm + Z) : N	
širina plošče - wb	wb = w - 31 mm	
dolžina spodnjega profila -L	L = U = w - 47.4 mm	
dolžina zgornjega profila -U		

število vrat - N	2	3
prekrivanje - Z	25 mm	50 mm

način prekrivanja - 4 krila	
	w = (W + 72) : 4
	w = (W : 2 + 22) : 2

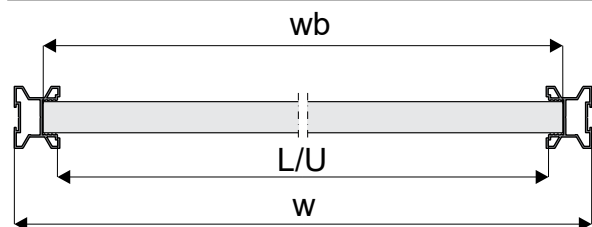

polnilo vrat - # 4 mm ogledalo ali steklo

višina polnila 4mm	hm	hm = hb
širina polnila 4mm	wm	wm = wb - 4 mm

POZOR!

Ob uporabi ogledala 4mm je obvezna uporaba varnostne folije. Varnostno steklo (4,5mm) je sestavljeno iz dveh tankih plasti stekla in folije.

Sevroll okovje za drsna vrata

Sistem MAXIM okvir je sistem, ki omogoča tako uporabo stekla 4 mm in plošče 18 mm z uporabo tesnila pa tudi kombinacijo obeh.

Sevroll MAXIM II
plošča



SEVROLL
MAXIM II
plošča

Sistem drsnih vrat MAXIM.

Sistem MAXIM II plošča je sistem, ki omogoča uporabo plošče 18 mm. Dvostranski ročaj PROSPER zagotavlja togost in enostavno uporabo. Kot pri ostalih sistemih SEVROLL so tudi tukaj uporabljena najboljše kolesa z ležaji ter nosilnostjo 50 kg.

Prednosti sistema MAXIM

- Nosilnosti do 50kg
- Možnost blaženja – soft close sistem za mirno in neslišno zapiranje vrat
- Možnost uporabe različnih materialov debeline 18mm
- Max. višina vrat do 2700mm

konstrukcija	sistem vodil	polnilo	nosilnost	maksimalna dolžina ročaja	maksimalna dolžina vodila
PLOŠČA	kolesa z ležajem	18mm	50 KG	2,7 m	3,5 m

Sevroll MAXIM II plošča



Artikel	Koda dobavitelja	Naziv	EM
MAXPRS27S	03145	Ročaj Prosper II, sistem MAXIM II, srebrni l=2,7m	kos

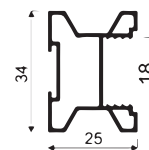

Artikel	Koda dobavitelja	Naziv	EM
MAXIIZV25S	02024	Zgornje vodilo MAXIM II, 2,5m, srebrni	kos
MAXIIZV35S	02298	Zgornje vodilo MAXIM II, 3,5m, srebrno	kos
MAXIISV25S	02806	Spodnje vodilo MAXIM II, 2,5m, srebrni	kos
MAXIISV35S	02808	Spodnje vodilo MAXIM II, 3,5m, srebrni	kos
MAXIIPSV25	02813	Pokrov spodnjega vodila, srebrna, 2,5m	kos
MAXIIPSV35	02815	Pokrov spodnjega vodila, srebrna, 3,5m	kos
MAXIIMP25S	01882	Sevroll MAXIM II montažni profil l=2,5m	kos

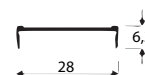
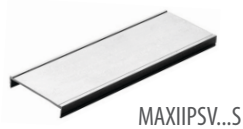
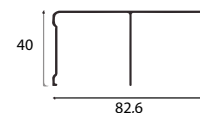

Artikel	Koda dobavitelja	Naziv	EM
SVRPLSK	10058	SEVROLL plošča, WD 18V, spodnja koleščka, 50 kg, set	kpl
MAXIIPLZK	10206	MAXIM plošča, zgornja koleščka, set	kpl



SVRPLSK

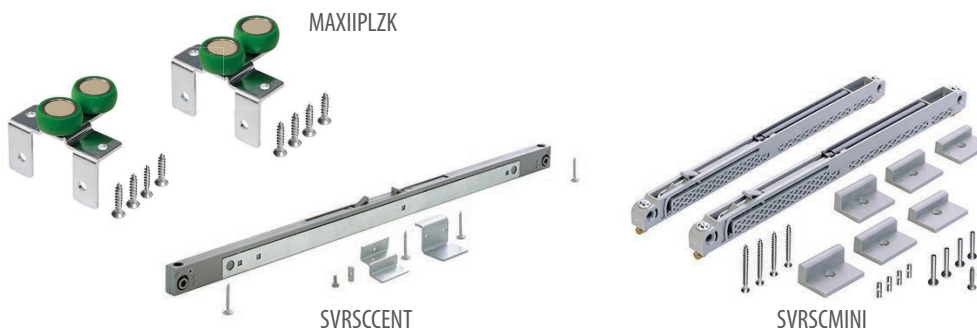

Artikel	Koda dobavitelja	Naziv	EM
SVRSCENT	20319-SV	Sevroll Soft close CENTRALNI 40kg, komplet za ena vrata	kpl
SVRSCMINI	20258-SV	Sevroll Soft close MINI 40kg, komplet za dvojna vrata	kpl

Sevroll MAXIM II Plošča

SVRLP3

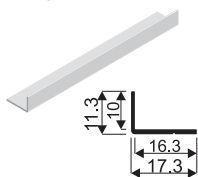

MAXIIMP25S

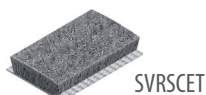
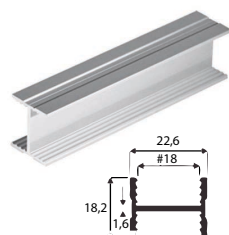

Artikel	Koda dobavitelja	Naziv	EM
SVRSTHT	20080	Sevroll štoper HI TEC	kos
SVRSCET	20224	SEVROLL ščetka za ročaj 14,5 x 4 mm brez lepila	tm
SVRLP3	00104	SEVROLL L profil mini - srebrni, l=3m	kos

Sevroll okovje za drsna vrata

Sevroll PROSPER
plošča

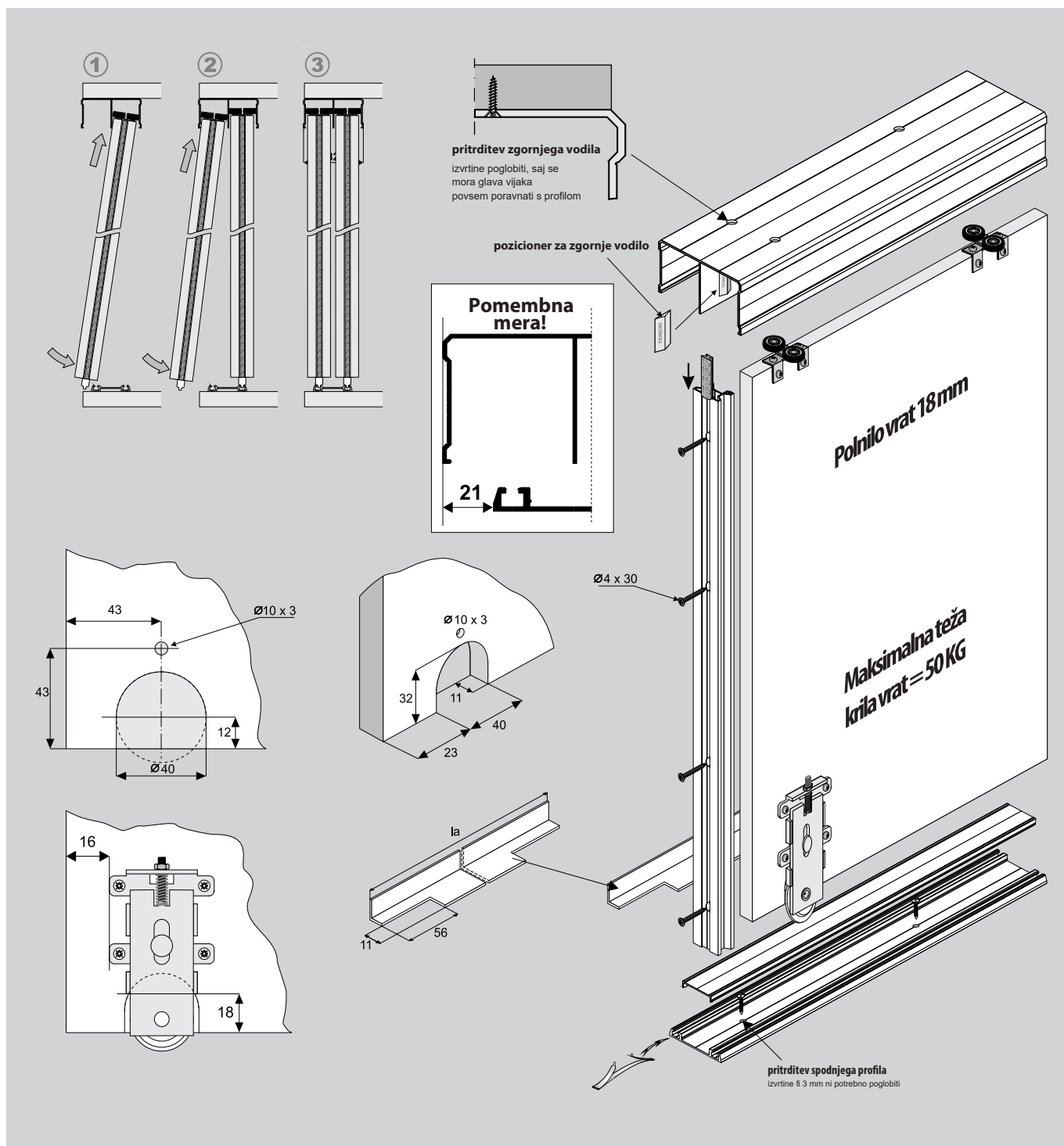

SESTAVNI DELI

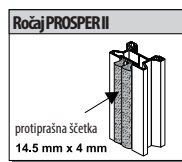

Dolžina: 2,7 m

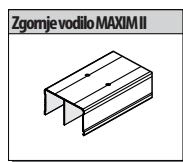

Dolžina: 2,5 m, 3,5 m

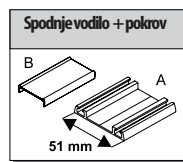

Dolžina: 2,5 m, 3,5 m

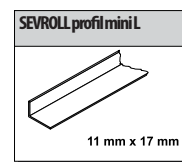
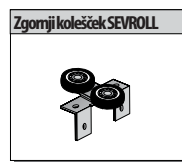
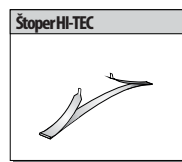

Dolžina: 3,0 m

Svetla mera

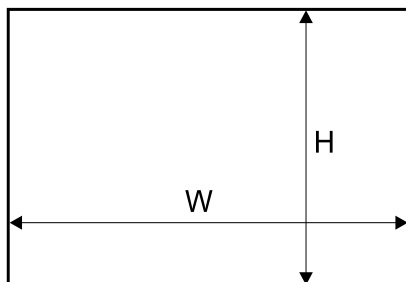

polnilo vrat - # 18 plošča

dolžina ročaja = višina vrat

višina vrat	- h	$h = H - 40 \text{ mm}$
višina vrat z blaženjem Mini SV40	- h	$h = H - 40 \text{ mm}$
višina vrat z blaženjem Central	- h	$h = H - 44 \text{ mm}$
višina polnila	- hb	$hb = h - 2 \text{ mm}$
širina vrat	- w	$w = (W - 3 + Z) : N$
širina polnila	- wb	$wb = d - 31 \text{ mm}$
dolžina zaključnega profila	- la	dolžina se določi po izdelavi vrat

število vrat	- N	2	3
prekrivanje	- Z	25 mm	50 mm

način prekrivanja	
	$w = (W + 72) : 4$
	$w = (W : 2 + 22) : 2$

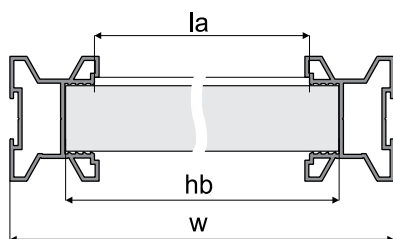

OPOZORILO!

Ročaj mora biti 2 mm daljši od višine polnila.

način montaže zgornjega kolesčka na polnilo 18mm

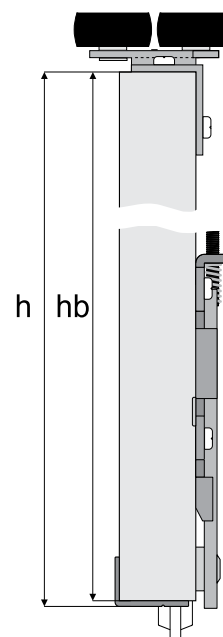

način montaže L mini profila

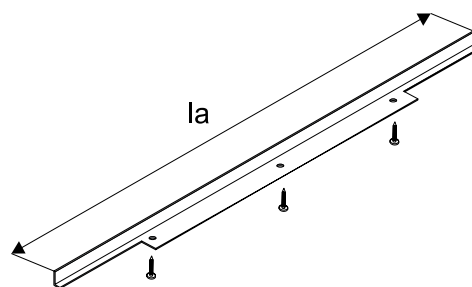

POZOR!

Zvijanje vrat zaradi uporabe neprimerne kvalitete polnila ni predmet reklamacije.

Sevroll okovje za drsna vrata

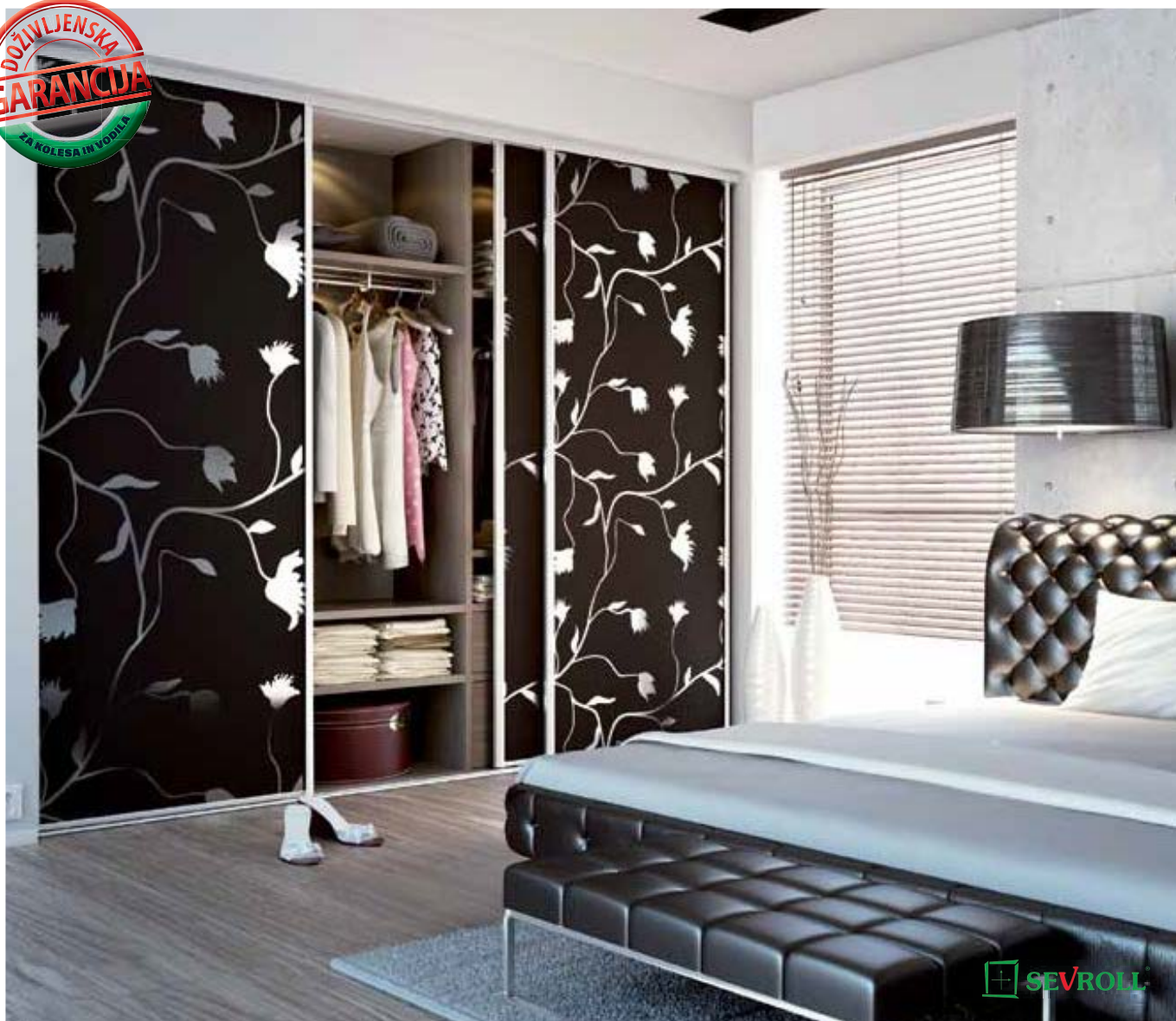

Sistem drsnih vrat GEMINI 18.

Sistem Gemini 18 je namenjen izdelavi drsnih vrat z nosilno konstrukcijo plošče, z elementi kot so H profili lahko polnila kombiniramo tudi s steklom ali ogledali (12 + 4 mm).

Na voljo sta dva ročaja, ki sta na evropskem trgu izredno priljubljena.

Kot pri ostalih sistemih SEVROLL so tudi tukaj uporabljena najboljša kolesa z ležaji ter nosilnostjo 50 kg.

- Nosilnosti do 50kg
- Možnost blaženja – soft close sistem za mirno in neslišno zapiranje vrat
- Možnost uporabe različnih materialov debeline 18mm ali kombinacijo 12mm + 4 mm steklo, ogledalo...
- Max. višina vrat do 2700mm

konstrukcija	sistem vodil	polnilo	nosilnost	maksimalna dolžina ročaja	maksimalna dolžina vodila
PLOŠČA	kolesa z ležajem	18mm ali 12+4mm	50 KG	2,7 m	4,05 m

Sevroll GEMINI 18
plošča



Artikel	Koda dobavitelja	Naziv	EM
GEMALFII27S	03628	Ročaj ALFA II, sistem GEMINI 18, srebrni l=2,7m	kos
GEMFAW27S	02697	Ročaj FAVORIT II, sistem GEMINI 18, srebrni l=2,7m	kos

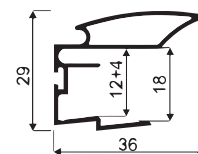

Artikel	Koda dobavitelja	Naziv	EM
GEMZV23S	01025	Zgornje vodilo GEMINI, 2,35m, srebrni	kos
GEMZV30S	01026	Zgornje vodilo GEMINI, 3,00m, srebrni	kos
GEMZV40S	01469	Zgornje vodilo GEMINI, 4,05m, srebrni	kos
GEMSV23S	01278	Spodnje vodilo Gemini, srebrni, l=2,35 m	kos
GEMSV30S	01279	Spodnje vodilo Gemini, srebrni, l=3,00 m	kos
GEMSV40S	01470	Spodnje vodilo Gemini, srebrni, l=4,05 m	kos

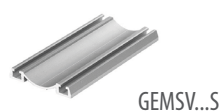
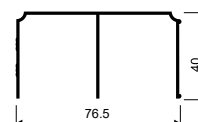
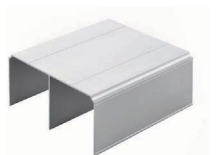

Artikel	Koda dobavitelja	Naziv	EM
SVRPLSK	10058	SEVROLL plošča, WD 18V, spodnja koleščka, 50 kg, set	kpl
SVRPLZK	10047	SEVROLL plošča, WPFc DUO, zgornja koleščka, set	kpl

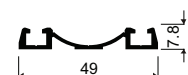

SVRPLSK

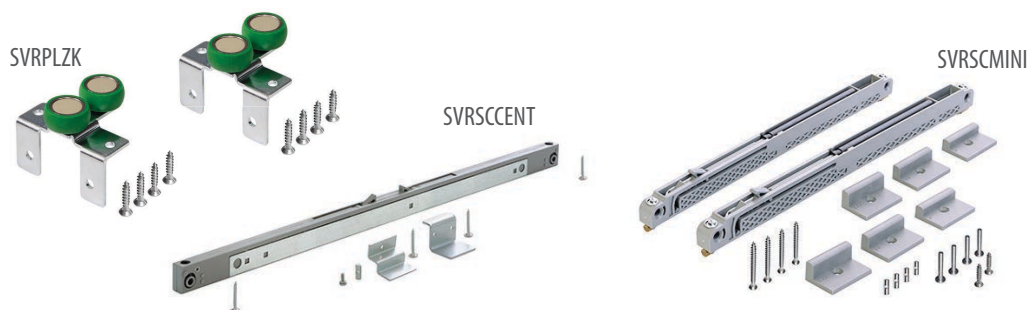

Artikel	Koda dobavitelja	Naziv	EM
SVRSCCENT	20319-SV	Sevroll Soft close CENTRALNI 40kg, komplet za ena vrata	kpl
SVRSCMINI	20258-SV	Sevroll Soft close MINI 40kg, komplet za dvojna vrata	kpl

Sevroll GEMINI 18

SVRLP3

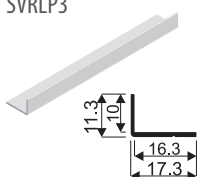

SVRPHP183



SVRSCET7

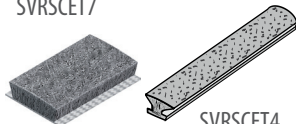

SVRSCET4



Artikel	Koda dobavitelja	Naziv	EM
SVRSTHT	20080	Sevroll štoper HI TEC	kos
SVRSCET4BL	20225	SEVROLL ščetka 4mm, brez lepila	tm
SVRSCET7	20227	SEVROLL ščetka 6,7mm x 13 z lepilom	tm
SVRPHP183	00215	SEVROLL PLOŠČA H profil 18mm, l=3m	kos
SVRPHP83	00199	SEVROLL PLOŠČA H profil 18/8mm, l=3m	kos
SVRLP3	00104	SEVROLL L profil mini - srebrni, l=3m	kos

Sevroll GEMINI 18 ALFA II *plošča*

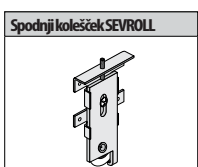
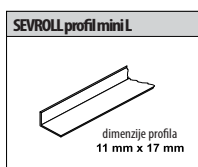
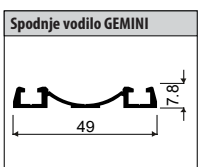
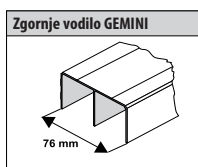
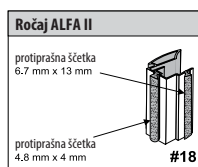
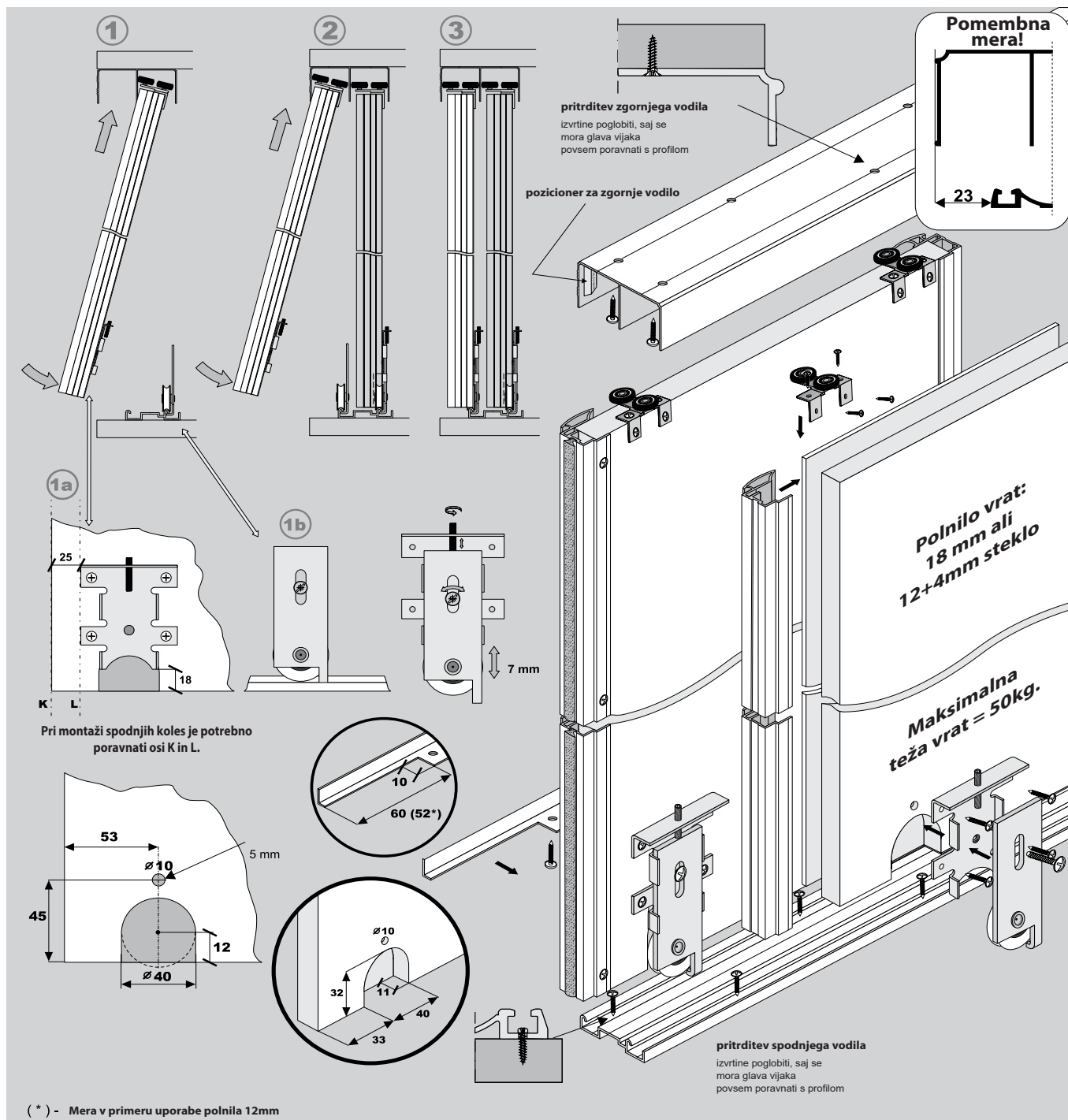

SESTAVNI DELI

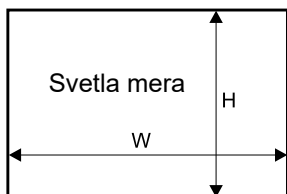

POZOR! Izračun je za ročaj z protiprašno ščetko.

dolžina ročaja = višina vrat

višina vrat	- h	$h = H - 42 \text{ mm}$
višina vrat z blaženjem Mini SV40	- h	$h = H - 42 \text{ mm}$
višina vrat z blaženjem Central	- h	$h = H - 44 \text{ mm}$
višina plošče	- hb	$hb = h - 2 \text{ mm}$
širina vrat	- w	$w = (W - 3 + Z) : N$
širina plošče #18	- wb	$wb = w - 22 \text{ mm}$
širina plošče #12	- wb _m	$wb_m = w - 7 \text{ mm}$
dolžina zaključnega profila	- la	dolžina se določi po izdelavi vrat

število vrat	- N	2	3
prekrivanje	- Z	36 mm	72 mm

način prekrivanja	
	$w = (W + 105) : 4$
	$w = (W : 2 + 33) : 2$

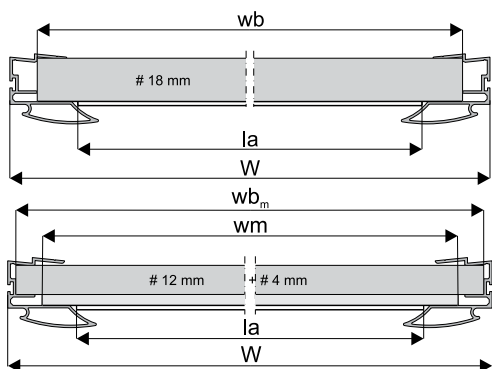

višina stekla	- hm = hb - 4 mm
širina stekla	- wm = wb _m - 20 mm

POZORI:
Spoje plošče in stekla ali ogledala je potrebno očistiti in razmastiti pred uporabo dvostranskega lepilnega traku.

Črtkana črta predstavlja priporočeno uporabo dvostranskega lepilnega traku.

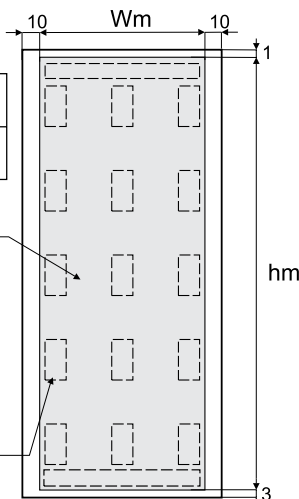

Pri montaži ročaja uporabite vijake in ne montažnega lepila.

način montaže zgornjega koleščka na polnilo 18mm

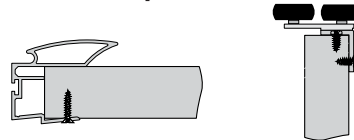

način montaže zgornjega koleščka na polnilo 12mm + 4mm stekla

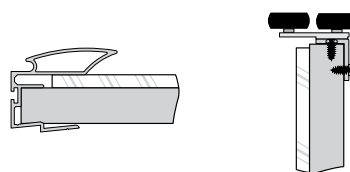

način montaže L mini profila

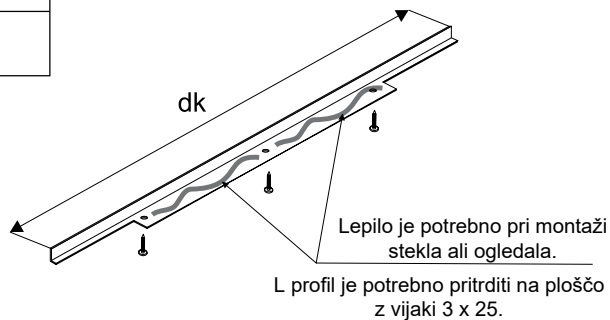
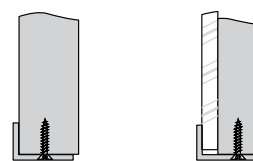

OPOZORILO!
Ročaj mora biti 2 mm daljši od višine polnila.

POZOR!
Zvijanje vrat zaradi uporabe neprimerne kvalitete polnila ni predmet reklamacije.

Sevroll GEMINI 18 FAVORIT *plošča*

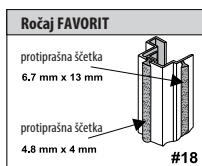
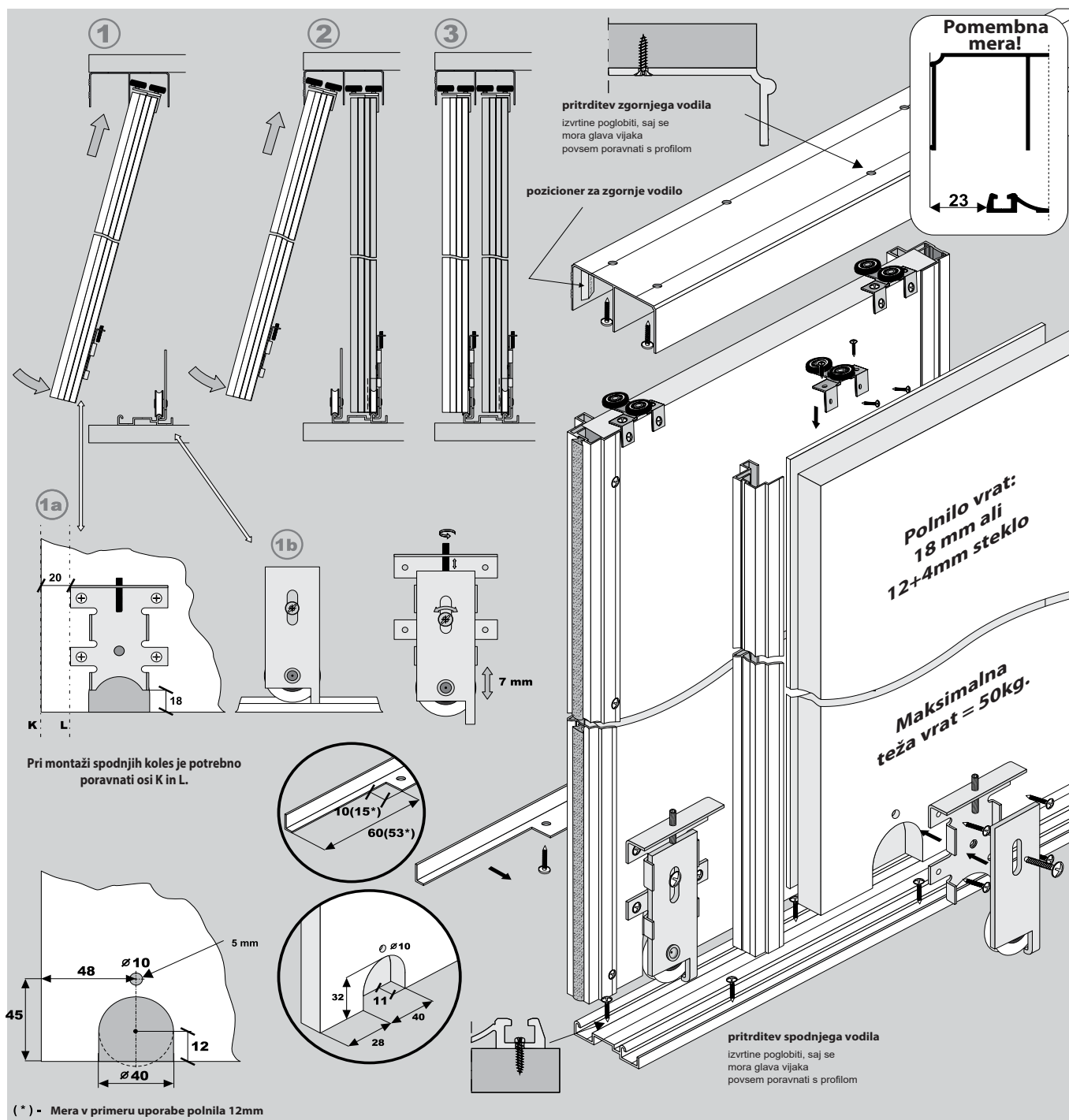

Dolžina: 2,70 m

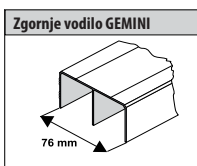

Dolžina: 2,35, 3,00, 4,05 m

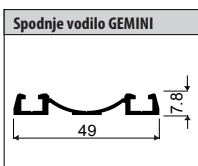

Dolžina: 2,35, 3,00, 4,05 m

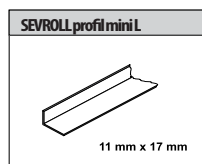

Dolžina: 3,00 m

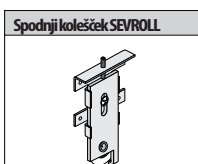

SESTAVNI DELI

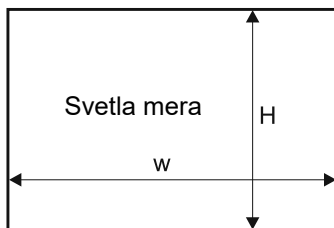

POZOR! Izračun je za ročaj z protiprašno ščetko.

dolžina ročaja = višina vrat

višina vrat	- h	$h = H - 42 \text{ mm}$
višina vrat z blaženjem Mini SV40	- h	$h = H - 42 \text{ mm}$
višina vrat z blaženjem Central	- h	$h = H - 44 \text{ mm}$
višina plošče	- hb	$hb = h - 2 \text{ mm}$
širina vrat	- w	$w = (W - 3 + Z) : N$
širina plošče #18	- wb	$wb = w - 19 \text{ mm}$
širina plošče #12	- wb _L	$wb_L = w - 7 \text{ mm}$
dolžina zaključnega profila - la		dolžina se določi po izdelavi vrat

število vrat	- N	2	3
prekrivanje	- Z	18 mm	36 mm

način prekrivanja	
	$w = (W + 51) : 4$
	$w = (W : 2 + 15) : 2$



višina stekla	- hm = hb - 4 mm
širina stekla	- wm = wb _L - 16 mm

POZORI!:
Spoje plošče in stekla ali ogledala je potrebno očistiti in razmastiti pred uporabo dvostranskega lepilnega traku.
Črtkana črta predstavlja priporočeno uporabo dvostranskega lepilnega traku.

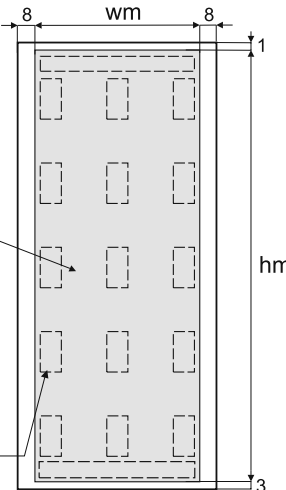

Pri montaži ročaja uporabite vijake in ne montažnega lepila.

način montaže zgornjega kolesčka na polnilo 18mm

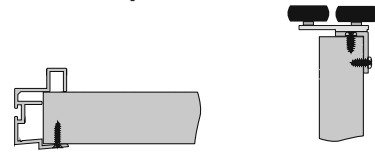

način montaže zgornjega kolesčka na polnilo 12mm + 4mm stekla

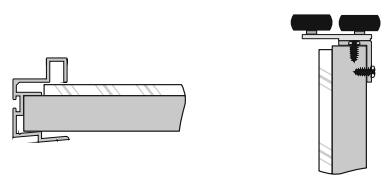

način montaže L mini profila

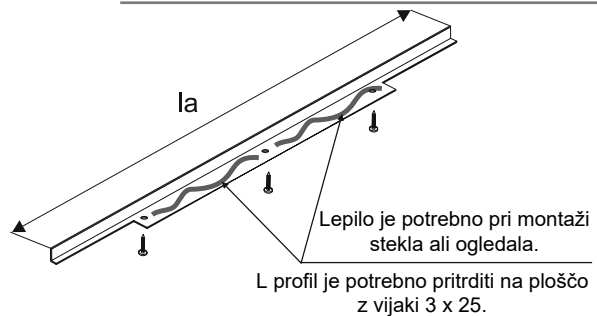
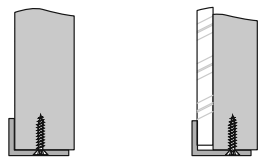

OPOZORILO!
Ročaj mora biti 2 mm daljši od višine polnila.

POZOR!
Zvijanje vrat zaradi uporabe neprimerne kvalitete polnila ni predmet reklamacije.

Sevroll okovje za drsna vrata



simpleblue OKVIR

- Primeren za polnila iz materiala debeline 18mm in varnostnega stekla debeline 4mm.
- Uporaba H delilnih letev omogoča kombinacijo lesa in stekla.
- Vijačenje H delilnih profilov in ročajev naredi vratno krilo bolj togo.
- Zahvaljujoč ozkim tračnicam (zgornje vodilo 68mm, spodnje vodilo le 44mm) je razdalja med vratnimi krili zmanjšana, kar pomeni, da je izguba prostora zaradi okovja minimalna.
- Sistem je nadgradljiv s sistemom za mehko zapiranje Sevromatic.

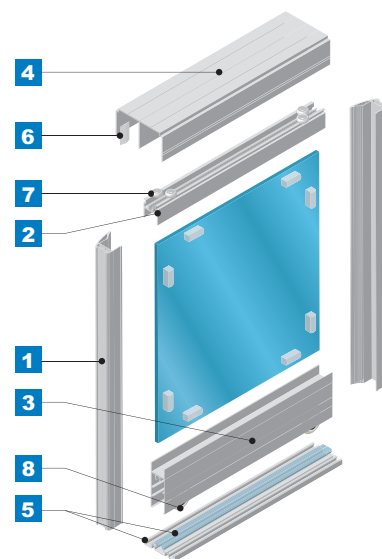

konstrukcija	sistem vodil	polnilo	nosilnost	maksimalna dolžina ročaja	maksimalna dolžina vodila
OKVIR	kolesa z ležajem	polnilo 18 mm ali 4mm steklo	35 KG	2,7 m	6,0 m

simpleblue 18 okvir



Artikel 1	Koda dobavitelja	Naziv	EM
SIBRLB27S	03446	Simple blue ročaj LIBRA - srebrni, l=2,7m	kos

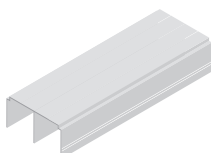
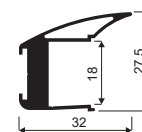

Artikel 2	Koda dobavitelja	Naziv	EM
SIBZGV2S	03714	Simple blue zgornje vodilo, 2m, srebrni	kos
SIBZGV3S	03400	Simple blue zgornje vodilo, 3m, srebrni	kos
SIBZGV4S	03727	Simple blue zgornje vodilo, 4m, srebrni	kos
SIBZGV6S	03469	Simple blue zgornje vodilo, 6m, srebrni	kos

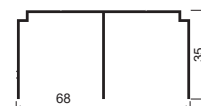

Artikel 3	Koda dobavitelja	Naziv	EM
SIBSPV2S	03710	Simple blue spodnje vodilo, l=2m	kos
SIBSPV3S	03427	Simple blue spodnje vodilo, l=3m	kos
SIBSPV4S	03729	Simple blue spodnje vodilo, l=4m	kos
SIBSPV6S	03470	Simple blue spodnje vodilo, l=6m	kos



Artikel 4	Koda dobavitelja	Naziv	EM
SIBOZP3	03592	Simple blue OKVIR zgornji profil, l=3m	kos

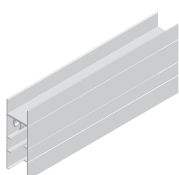
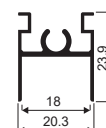

Artikel 5	Koda dobavitelja	Naziv	EM
SIBOSP3	03590	Simple blue OKVIR spodnji profil, l=3m	kos

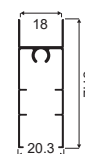

Artikel	Koda dobavitelja	Naziv	EM
SVRSCENT	20319-SV	Sevroll Soft close CENTRALNI 40kg, komplet za ena vrata	kpl
SVRSCMINI	20258-SV	Sevroll Soft close MINI 40kg, komplet za dvojna vrata	kpl



simpleblue 18 okvir

SIBTSV

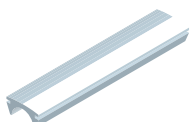

SIBP



SVRSCET

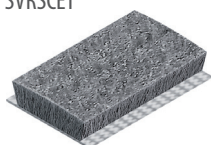

SIBV632

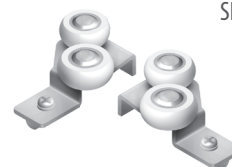

SIBOKZD/L

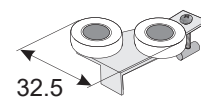

SIBOHP3

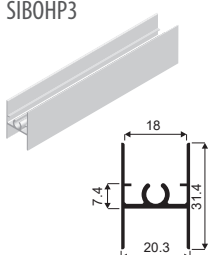

Artikel	Koda dobavitelja	Naziv	EM
SIBOKZD	7 10156-R	Simple blue OKVIR kolesček zgornji desni	kos
SIBOKZL	7 10156-L	Simple blue OKVIR kolesček zgornji levi	kos
SIBPS	20234	Simple blue OKVIR podloga-distančnik za steklo	kos
SIBV632	20001	Sevroll vijak 6x32	kos
SIBTSV	20233	Simple blue tesnilo za spodnje vodilo	tm
SIBP	6 20240	Simple blue pozicioner za zgornje vodilo	kos
SIBOSPK	8 10139	Simple blue OKVIR spodnji kolesček	kos
SIBOHP3	03445	Simple blue OKVIR H profil l=3m, srebrna	kos
SVRSCET	20224	SEVROLL ščetka za ročaj 14,5 x 4 mm brez lepila	tm

SIBOSPK



SIBPS

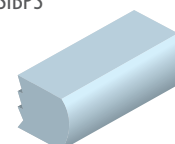

simpleblue 18 Libra
okvir

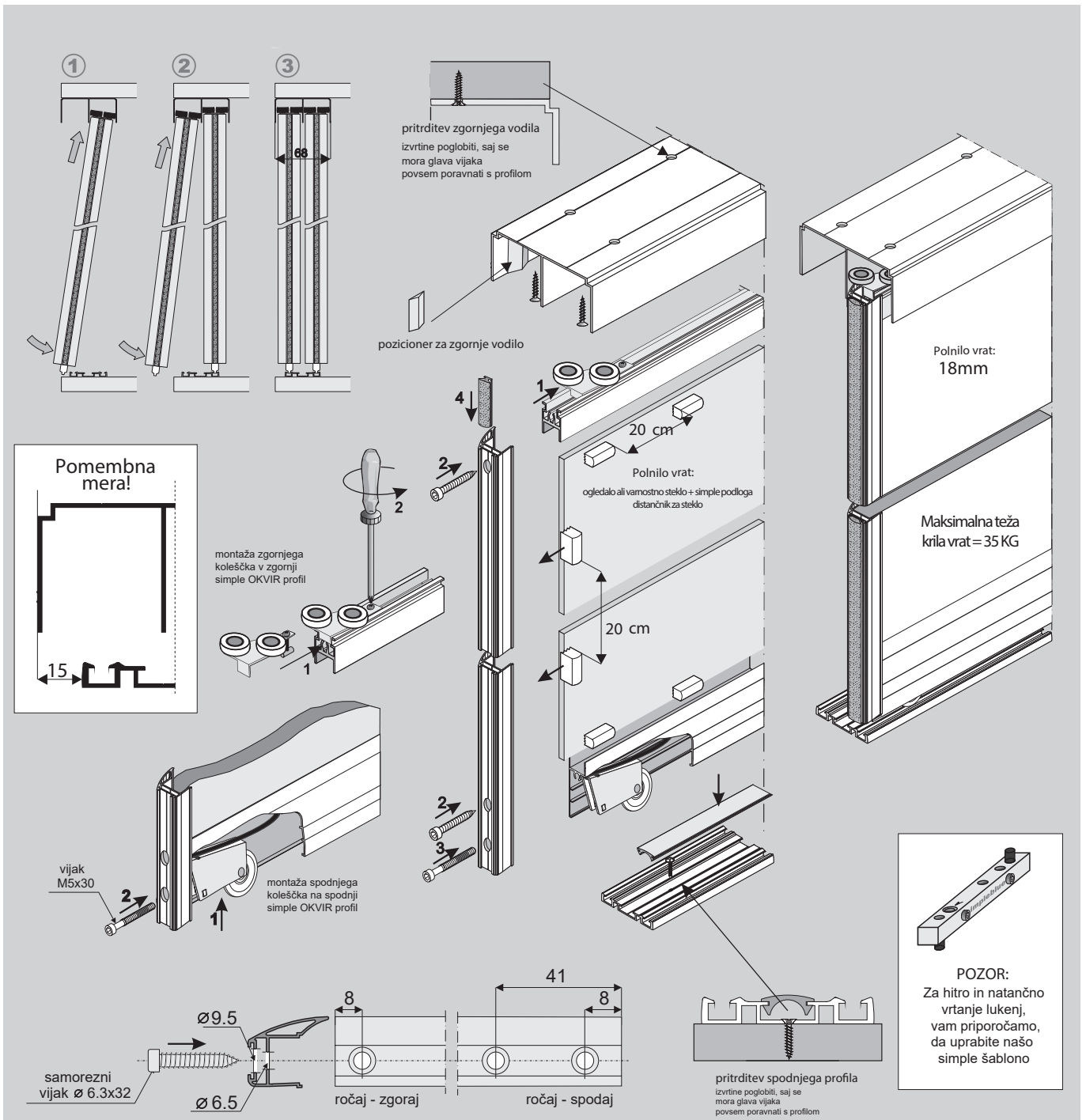

SESTAVNI DELI

<p>ročaj Libra</p> <p>simple ščetka za ročaj 14,5m x 4 mm</p> <p>Dolžina: 2,7 m</p>	<p>simple zgornje vodilo</p> <p>68 mm</p> <p>Dolžina: 2,0 m, 3,0 m, 6,0 m</p>	<p>simple spodnje vodilo</p> <p>44 mm</p> <p>Dolžina: 2,0 m, 3,0 m, 6,0 m</p>	<p>tesnilo za spodnje vodilo</p> <p>Dolžina: 1,0 m</p>	<p>simple blue OKVIR H profil</p> <p>Dolžina: 3,0 m</p>	<p>simple PLOŠČA H profil</p> <p>Dolžina: 3,0 m</p>
<p>simple OKVIR zgornji profil</p> <p>Dolžina: 3,0 m</p>	<p>simple OKVIR spodnji profil</p> <p>Dolžina: 3,0 m</p>	<p>simple OKVIR kolesček zgornji levi in desni</p>	<p>simple OKVIR kolesček spodnji</p>	<p>samorezni vijak Ø 6,3x32</p>	<p>simple podloga - distančnik za steklo</p>

svetla mera

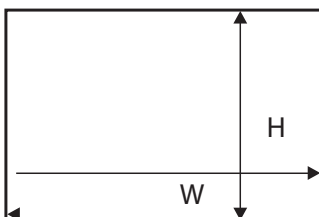

uporabne mere pri
montaži sredinskega H profila
simple OKVIR sistem

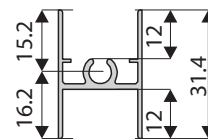

polnilo vrat - 18 mm

višina vrat brez blaženja	h	$h = H - 33 \text{ mm}$
višina vrat z blaženjem	h	$h = H - 39 \text{ mm}$
višina polnila	hb	$hb = h - 61 \text{ mm}$
širina vrat	w	$w = (W - 3 \text{ mm} + Z) : N$
širina polnila	wb	$wb = w - 17 \text{ mm}$
dolžina horizontalnega profila	L	$L = U = w - 40,4 \text{ mm}$
dolžina zgornjega H profila	U	

način montaže s polnilom 18mm (slika A)
in način montaže s polnilom 4mm steklo
ali ogledalo (slika B)

- ročaj

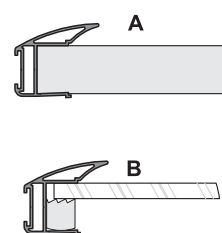

število vrat	N	2	3
prekrivanje	Z	32 mm	64 mm

- zgornji profil

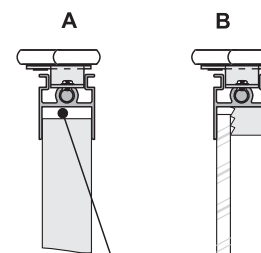

pri izračunu višine polnila
upoštevati raztezanje materiala

- spodnji profil

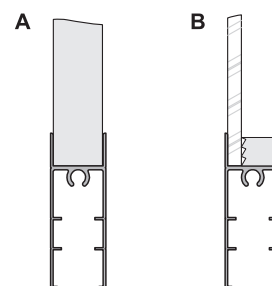

način prekrivanja -	4 krila
	$w = (W + 93) : 4$
	$w = (W : 2 + 29) : 2$

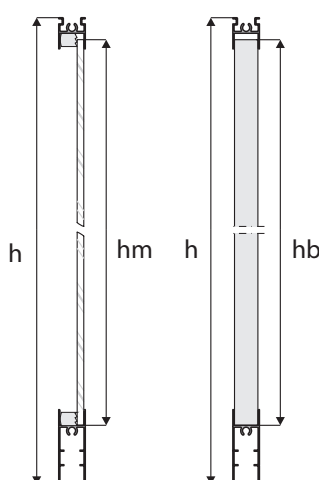
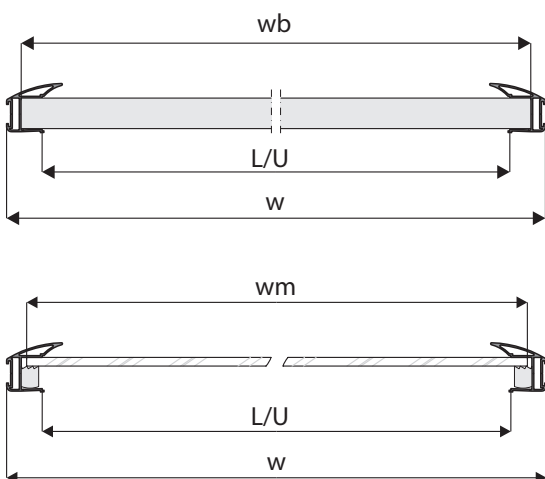

polnilo vrat - 4mm steklo ali ogledalo

višina stekla	hm	$hm = hb$
širina stekla	wm	$wm = wb - 4 \text{ mm}$

POZOR!

Ob uporabi ogledala 4mm je obvezna uporaba
varnostne folije. Varnostno steklo (4,5mm) je
sestavljeno iz dveh tankih plasti stekla in folije.

simpleblue 18^{mm} plošča



simpleblue PLOŠČA

- Enostaven in ekonomičen sistem drsnih vrat.
- Zahvaljujoč ozkim tračnicam (zgornje vodilo 68mm, spodnje vodilo le 44mm) je razdalja med vratnimi krili zmanjšana, kar pomeni, da je izguba prostora zaradi okovja minimalna.
- Sistem je nadgradljiv s sistemom za mehko zapiranje **Sevromatic**.

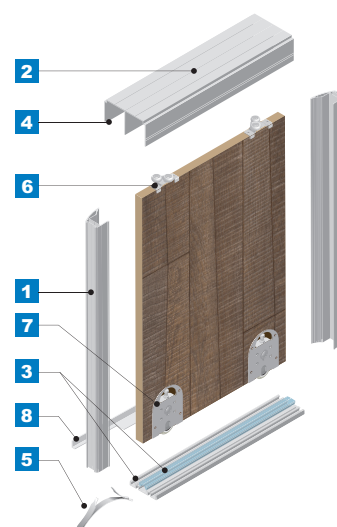

konstrukcija	sistem vodil	polnilo	nosilnost	maksimalna dolžina ročaja	maksimalna dolžina vodila
PLOŠČA	kolesa z ležajem	polnilo 18 mm	35 KG	2,7 m	6,0 m

simpleblue 18 plošča

LIBRA

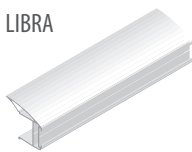

ROMA

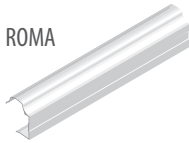

UNO

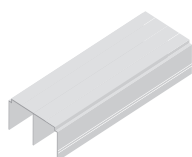
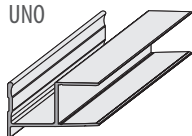

Artikel 1	Koda dobavitelja	Naziv	EM
SIBRLB27S	03446	Simple blue ročaj LIBRA - srebrni, l=2,7m	kos
SIBRRO27S	00001	Simple blue ročaj ROMA - srebrni, l=2,7m	kos
SIBRUNO27S	00002	Simple blue ročaj UNO - srebrni, l=2,7m	kos

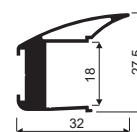

Artikel 2	Koda dobavitelja	Naziv	EM
SIBZGV2S	03714	Simple blue zgornje vodilo, 2m, srebrni	kos
SIBZGV3S	03400	Simple blue zgornje vodilo, 3m, srebrni	kos
SIBZGV4S	03727	Simple blue zgornje vodilo, 4m, srebrni	kos
SIBZGV6S	03469	Simple blue zgornje vodilo, 6m, srebrni	kos

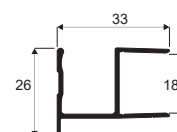
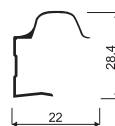

Artikel 3	Koda dobavitelja	Naziv	EM
SIBSPV2S	03710	Simple blue spodnje vodilo, l=2m	kos
SIBSPV3S	03427	Simple blue spodnje vodilo, l=3m	kos
SIBSPV4S	03729	Simple blue spodnje vodilo, l=4m	kos
SIBSPV6S	03470	Simple blue spodnje vodilo, l=6m	kos

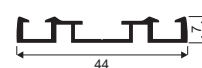

Artikel 7	Koda dobavitelja	Naziv	EM
SIBPSPK	10157	Simple blue PLOŠČA spodnji kolešček	kos

Artikel	Koda dobavitelja	Naziv	EM
SVRSCCENT	20319-SV	Sevroll Soft close CENTRALNI 40kg, komplet za ena vrata	kpl
SVRSCMINI	20258-SV	Sevroll Soft close MINI 40kg, komplet za dvojna vrata	kpl



simpleblue 18 plošča

SIBTSV

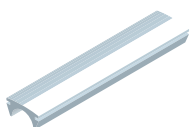

SIBP



SVRSCET

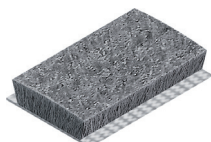

SIBOST



SIBPKZD/L

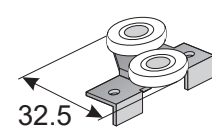
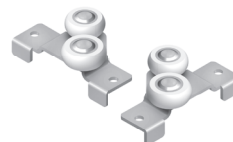

SIBPHP3

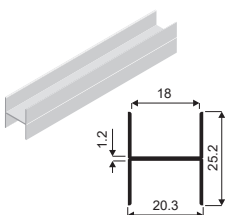

Artikel	Koda dobavitelja	Naziv	EM
SIBPKZD	6 10135-R	Simple blue PLOŠČA kolešček zgornji desni	kos
SIBPKZL	6 10135-L	Simple blue PLOŠČA kolešček zgornji levi	kos
SIBPKZSIM	6 10184	Simple blue PLOŠČA kolešček zgornji simetričen (ročaj Uno)	kos
SIBTSV	3 20233	Simple blue tesnilo za spodnje vodilo	tm
SIBP	4 20240	Simple blue pozicioner za zgornje vodilo	kos
SIBOST	5 10163	Simple blue PLOŠČA zaustavljalec za spodnje vodilo	kos
SIBPHP3	03444	Simple blue PLOŠČA H profil l=3m, srebrna	kos
SVRSCET	20224	SEVROLL ščetka za ročaj 14,5 x 4 mm brez lepila	tm
SVRLP3	8 00104	SEVROLL L profil mini - srebrni, l=3m	kos
SVRPHP83	00199	SEVROLL PLOŠČA H profil 18/8mm, l=3m	kos

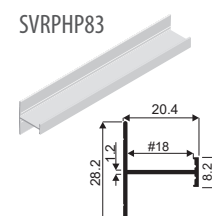
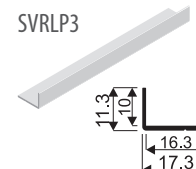

simpleblue okovje za drsna vrata

simpleblue 18 Libra *plus*

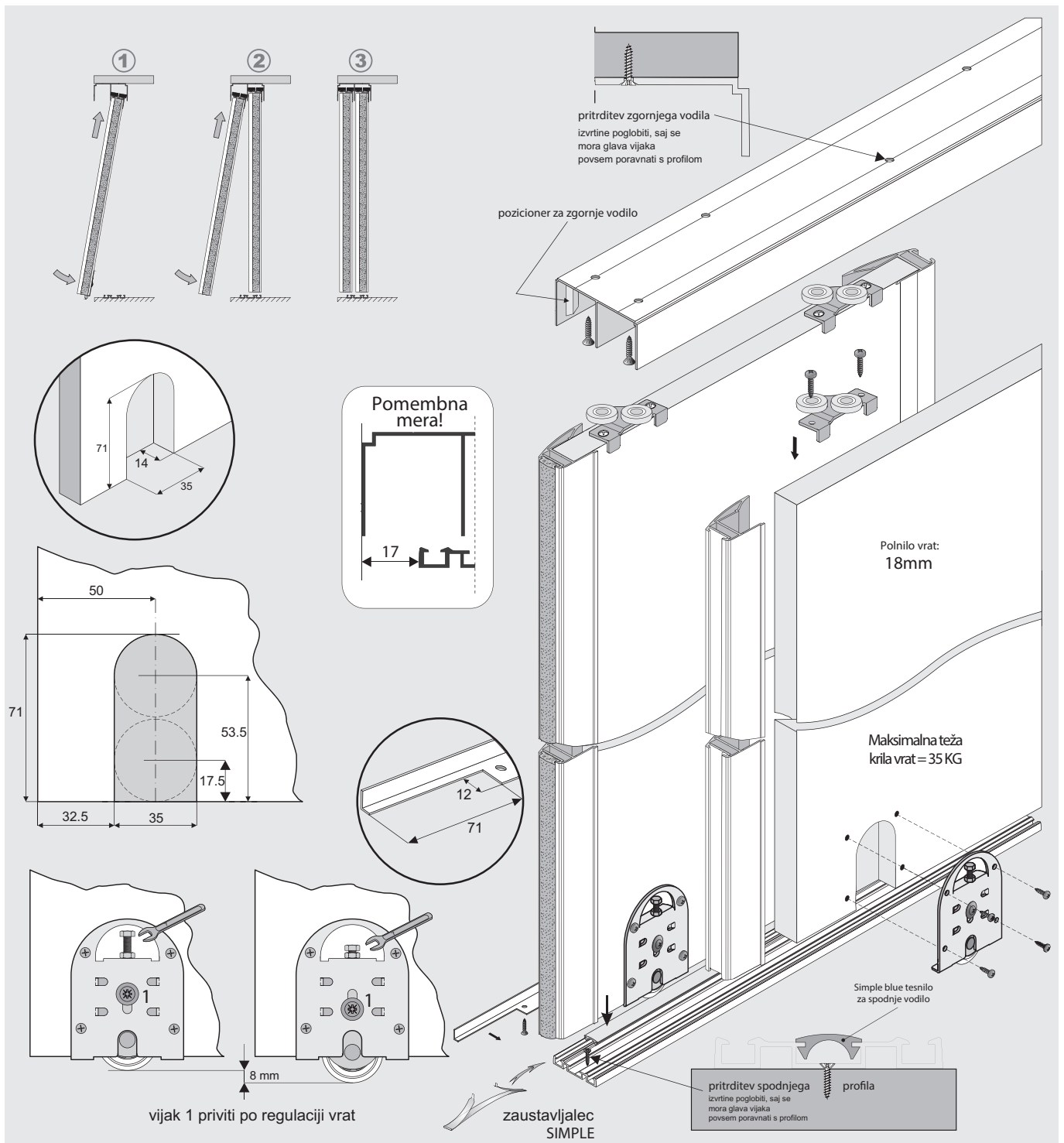

SESTAVNI DELI

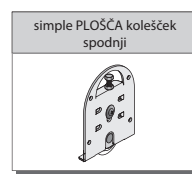
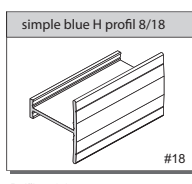
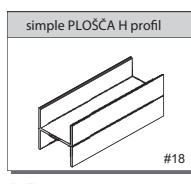
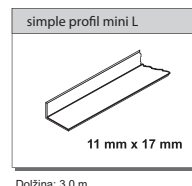
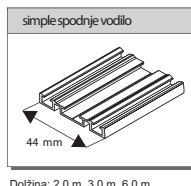
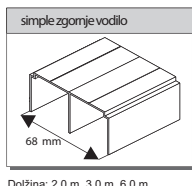
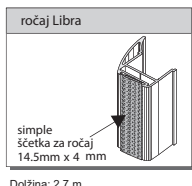

Svetla mera

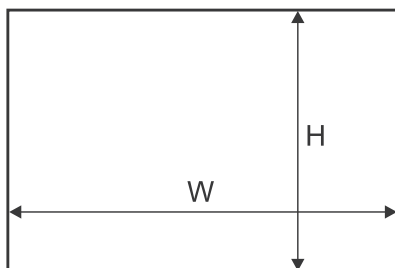

polnilo vrat 18 mm

dolžina ročaja = višina vrat

višina vrat brez blaženja	h	$h = H - 36 \text{ mm}$
višina vrat z blaženjem	h	$h = H - 42 \text{ mm}$
višina plošče	hb	$hb = h - 1 \text{ mm}$
širina vrat	w	$w = (W - 3 \text{ mm} + Z) : N$
širina plošče	wb	$wb = w - 17 \text{ mm}$
dolžina L profila	la	dolžina se določi po izdelavi vrat

število vrat	N	2	3
prekrivanje	Z	32 mm	64 mm

način prekrivanja - 4 krila	
	$w = (W + 93) : 4$
	$w = (W : 2 + 29) : 2$

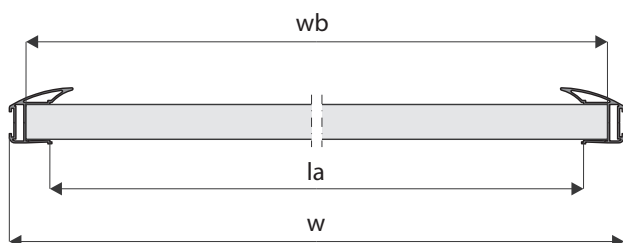

pri montaži ročajev ne uporabljajte montažnega lepila

način montaže ročaja in zgornjega kolesčka na polnilo 18mm

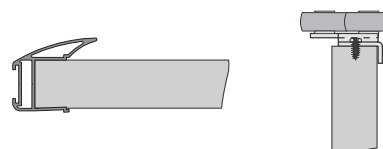

način montaže L mini profila

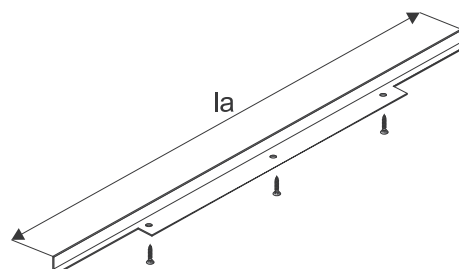

POZOR!

Zvijanje vrat zaradi uporabe neprimerne kvalitete polnila ni predmet reklamacije.

simpleblue 18 Roma *plōša*

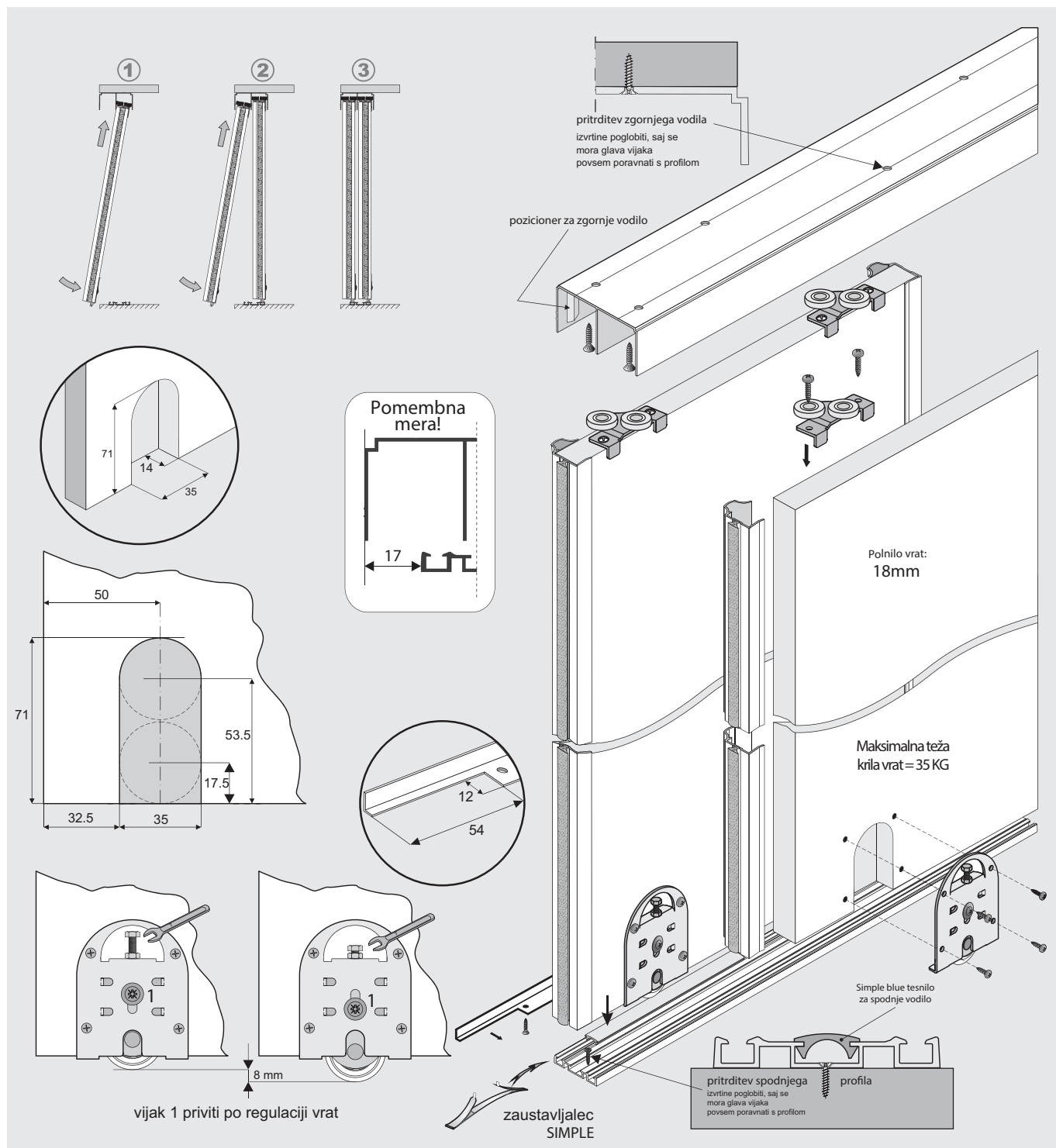

SESTAVNI DELI

<p>ročaj ROMA</p> <p>simple ščetka za ročaj 4,8 mm x 4 m m</p> <p>Dolžina: 2,7 m</p>	<p>simple zgornje vodilo</p> <p>68 mm</p> <p>Dolžina: 2,0 m, 3,0 m, 6,0 m</p>	<p>simple spodnje vodilo</p> <p>44 mm</p> <p>Dolžina: 2,0 m, 3,0 m, 6,0 m</p>	<p>tesnilo za spodnje vodilo</p> <p>Dolžina: 1,0 m</p>	<p>simple profil mini L</p> <p>11 mm x 17 mm</p> <p>Dolžina: 3,0 m</p>
<p>simple PLOŠČA kolesček zgornji levi in desni</p>	<p>simple PLOŠČA kolesček spodnji</p>	<p>simple PLOŠČA H profil</p> <p>#18</p> <p>Dolžina: 3,0 m</p>	<p>simple blue H profil 8/18</p> <p>#18</p> <p>Dolžina: 3,0 m</p>	

svetla mera

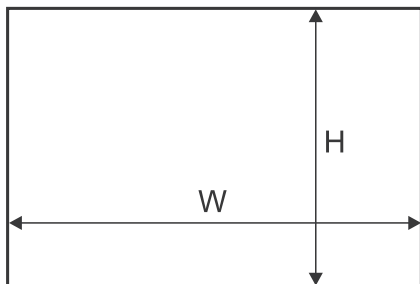

polnilo vrat 18mm

dolžina ročaja = višina vrat

višina vrat brez blaženja	h	$h = H - 36 \text{ mm}$
višina vrat z blaženjem	h	$h = H - 42 \text{ mm}$
višina plošče	hb	$hb = h - 1 \text{ mm}$
širina vrat	w	$w = (W - 3 + Z) : N$
širina plošče	wb	$wb = w - 3 \text{ mm}$
dolžina L profila	la	dolžina se določi po izdelavi vrat

število vrat	N	2	3
prekrivanje	Z	29 mm	58 mm

način prekrivanja - 4 krila	
	$w = (W + 84) : 4$
	$w = (W : 2 + 26) : 2$

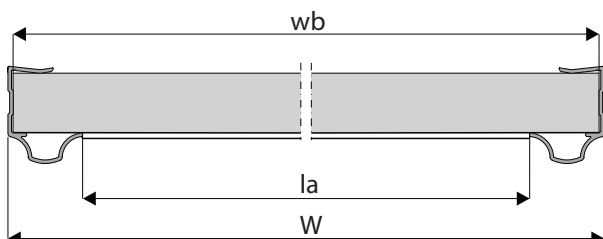

POZOR!
Dolžina profila ročaja je $hb + 2\text{mm}$.

pri montaži ročajev ne uporabljajte montažnega lepila

način montaže ročaja in zgornjega kolesčka na polnilo 18mm

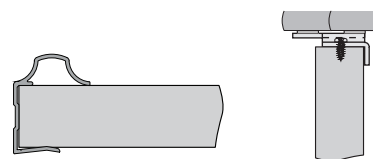

način montaže L mini profila

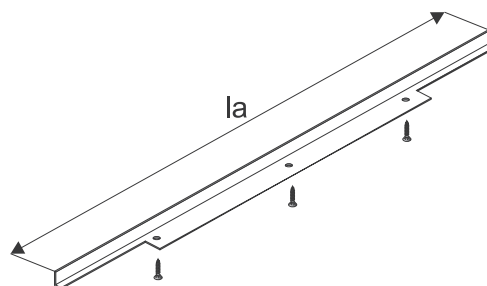

OPOZORILO!

Zvijanje vrat zaradi uporabe neprimerne kvalitete polnila ni predmet reklamacije.

simpleblue okovje za drsna vrata

simpleblue 18 Uno plošča

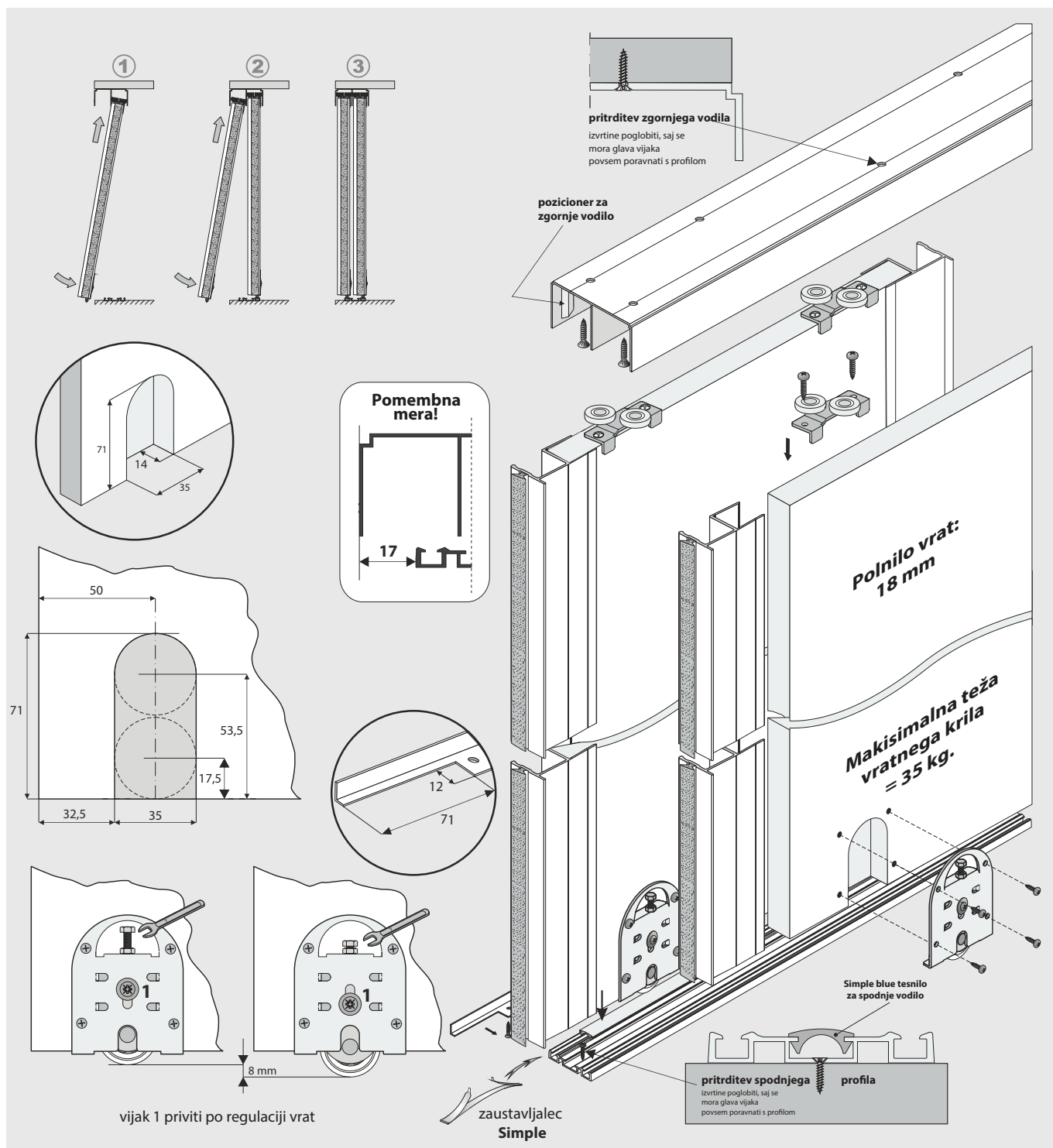

SESTAVNI DELI

<p>ročaj UNO</p> <p>ščetka za ročaj 4,8 mm x 4 mm</p> <p>Dolžina: 2,7 m</p>	<p>simple zgornje vodilo</p> <p>68 mm</p> <p>Dolžina: 2,0 m, 3,0 m, 6,0 m</p>	<p>simple spodnje vodilo</p> <p>44 mm</p> <p>Dolžina: 2,0 m, 3,0 m, 6,0 m</p>	<p>tesnilo za spodnje vodilo</p> <p>Dolžina: 1,0 m</p>
<p>simple PLOŠČA H profil</p> <p>Dolžina: 3,0 m</p>	<p>simple PLOŠČA kolesček simetričen</p>	<p>simple blue H profil 8/18</p> <p>Dolžina: 3,0 m</p>	<p>simple PLOŠČA kolesček spodnji</p>

svetla mera

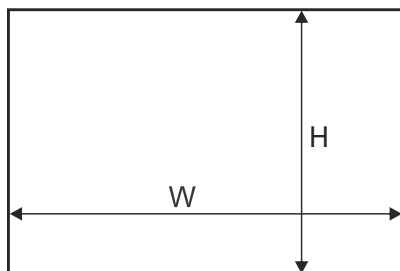

dolžina ročaja = višina vrat

polnilo vrat 18mm

višina vrat z blaženjem		$h = H - 36 \text{ mm}$
višina vrat z blaženjem	h	$h = H - 42 \text{ mm}$
višina plošče	hb	$hb = h - 1 \text{ mm}$
širina vrat	w	$w = (W - 3 + Z) : N$
širina plošče	wb	$wb = w - 36 \text{ mm}$
dolžina L profila	la	dolžina se določi po izdelavi vrat

število vrat	N	2	3
prekrivanje	Z	33 mm	66 mm

način prekrivanja	4 krila
	$w = (W + 96) : 4$
	$w = (W : 2 + 30) : 2$

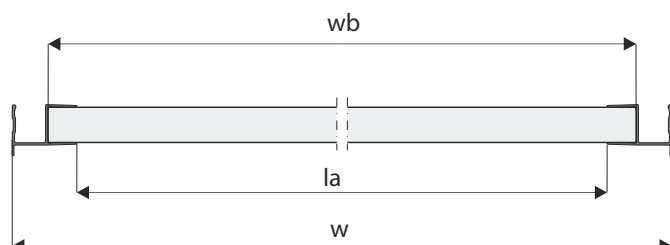

pri montaži ročajev ne uporabljajte montažnega lepila

način montaže ročaja in zgornjega kolesčka na polnilo 18mm

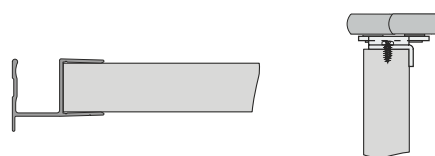

način montaže L mini profila

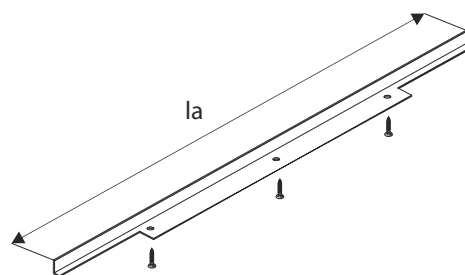

OPOZORILO!

Zvijanje vrat zaradi uporabe neprimerne kvalitete polnila ni predmet reklamacije.





SEVROLL®

SEVROMATIC

SV-40 mini

Sevromatic SV-40, blažilec za drsna vrata moči 40 kg.
SET vključuje vse potrebno za montažo dveh blažilcev
na sistem okvir ali plošča.

Primeren za sisteme :

SimpleBLUE

MAXIM 18

GEMINI PAX

GEMINI II



ident: SVRSCMINI

OKVIR

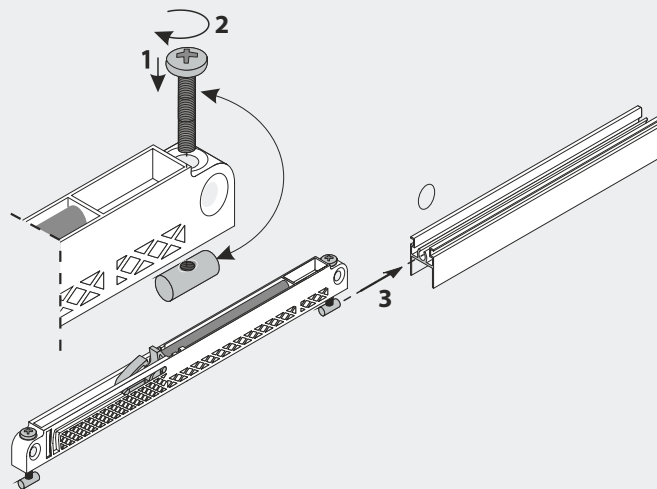

Montaža soft close mehanizma pri sistemu okvir.

POZOR!

Pri vgradnji soft close mehanizma je potrebno izračunati višino vratnega krila s formulo $h = H - 39 \text{ mm}$

POZOR!
Pred vgradnjo vratnega krila je potrebno napeti soft close mehanizem.

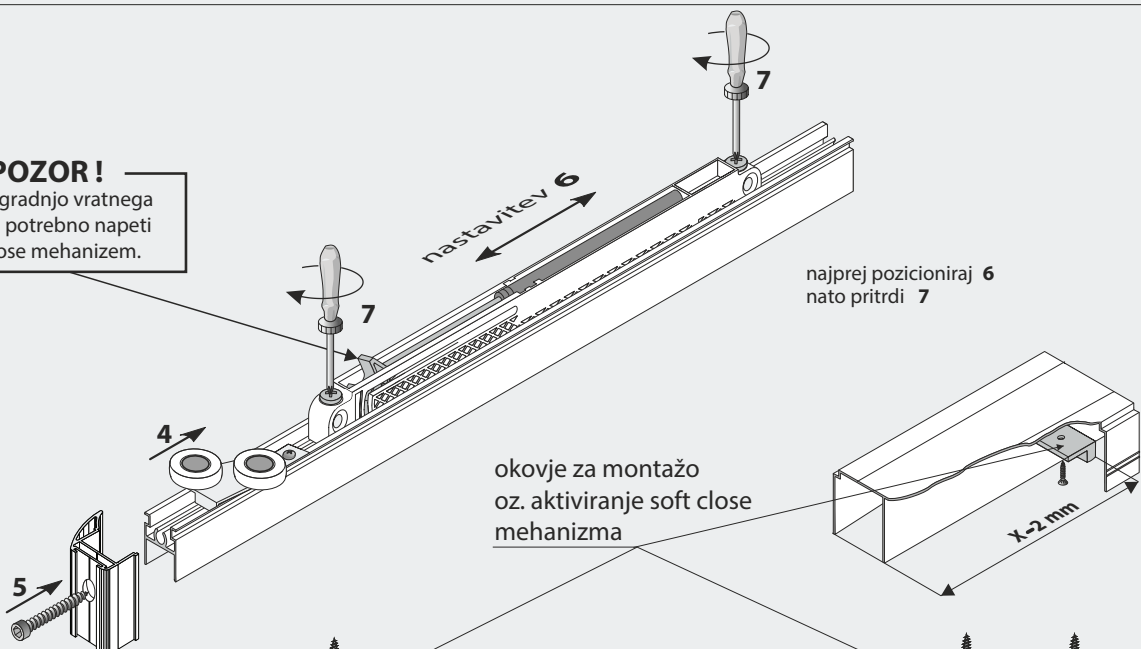

najprej pozicioniraj 6 nato pritrdi 7

okovje za montažo oz. aktiviranje soft close mehanizma

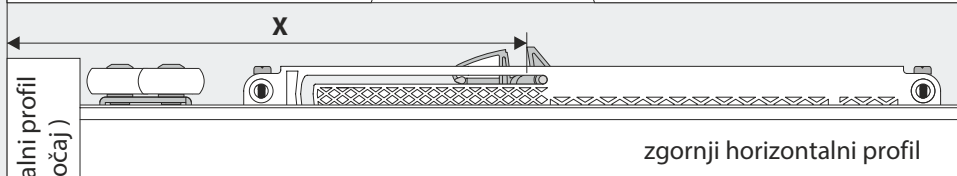
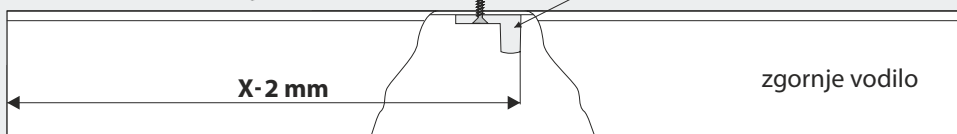

Vertikalni profil (ročaj)

Pozor!

Set za montažo oz. aktiviranje soft close mehanizma sestoji iz treh kotnikov različnih višin. Po vgradnji vratnega krila izberite primerne.

Ne uporabljaj spodnjih pozicionerjev s soft close mehanizmom!

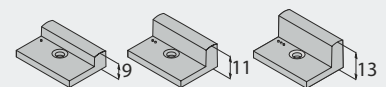

Soft-close za drsna vrata simpleBLUE

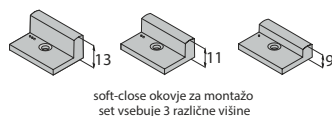
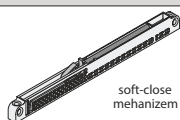

pritrilni čep - 2 kosa

vijaki M 3 x 20 - 2 kosa

vijaki M 3 x 25 - 2 kosa



distančnik - 2 kosa

vijaki 3.5 x 40 - 2 kosa

vijaki 3 x 16 - 1 kos



Montaža soft close mehanizma pri sistemu SIMPLE 18 plošča

POZOR!

Pri vgradnji soft close mehanizma je potrebno izračunati višino vratnega krila s formulo $h = H - 42 \text{ mm}$

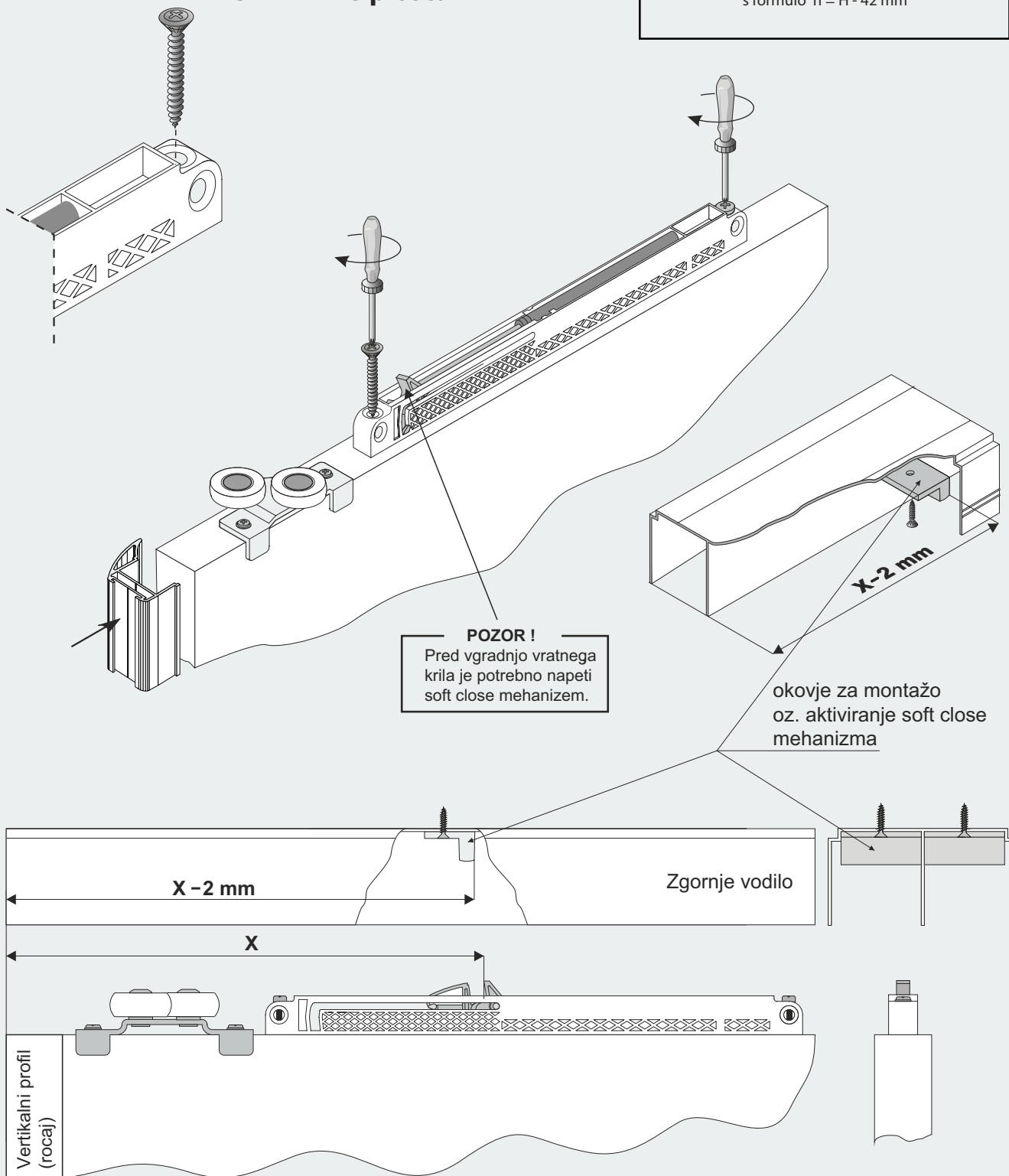

Sevroll MICRA



Sistem drsnih vrat MICRA za enostavno in funkcionalno pohištvo.

Sistem MICRA je enostaven sistem drsnih vrat, kot že samo ime nakazuje MICRA, je minimalističen in enostaven za montažo. Same karakteristike pa so vse prej kot mikro. Maksimalna teža vrat 50 kg in debelina vratnih kril do 50 mm sta samo dve prednosti MICRE.

Prednosti sistema MICRA

- Možna uporaba vseh ročajev SEVROLL
- Kolesa se montirajo brez rezkanja
- Nosilnost 50 kg (vrata)
- Kolesa z ležajem
- Vodilo je enako zgoraj in spodaj - tirnica

konstrukcija	sistem vodil	polnilo	nosilnost	maksimalna dolžina ročaja	maksimalna dolžina vodila
PLOŠČA	kolesa z ležajem	PLOŠČA 16-50 MM	50 KG	NI NA VOLJO	3,00 m

Sevroll MICRA

Artikel	Koda dobavitelja	Naziv	EM
SEVMICK	10199	Sevroll Micra komplet kolesčkov za 1 vrata	kpl



Artikel	Koda dobavitelja	Naziv	EM
SEVMICV	01120	Sevroll Micra vodilo l=3,0 m	kos

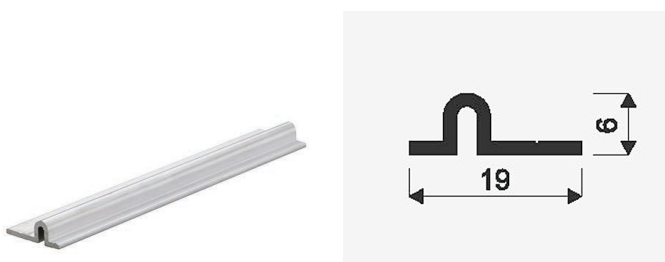

Artikel	Koda dobavitelja	Naziv	EM
SEVMICLP	00080	Sevroll Micra L-profil L=3,0 m	kos

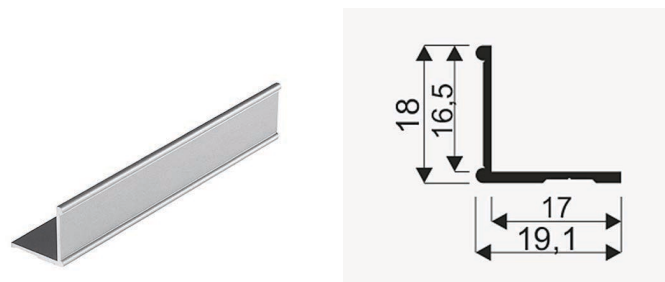

Šablona za pritrditvev spodnji in zgornjih kolesčkov SEVROLL MICRA

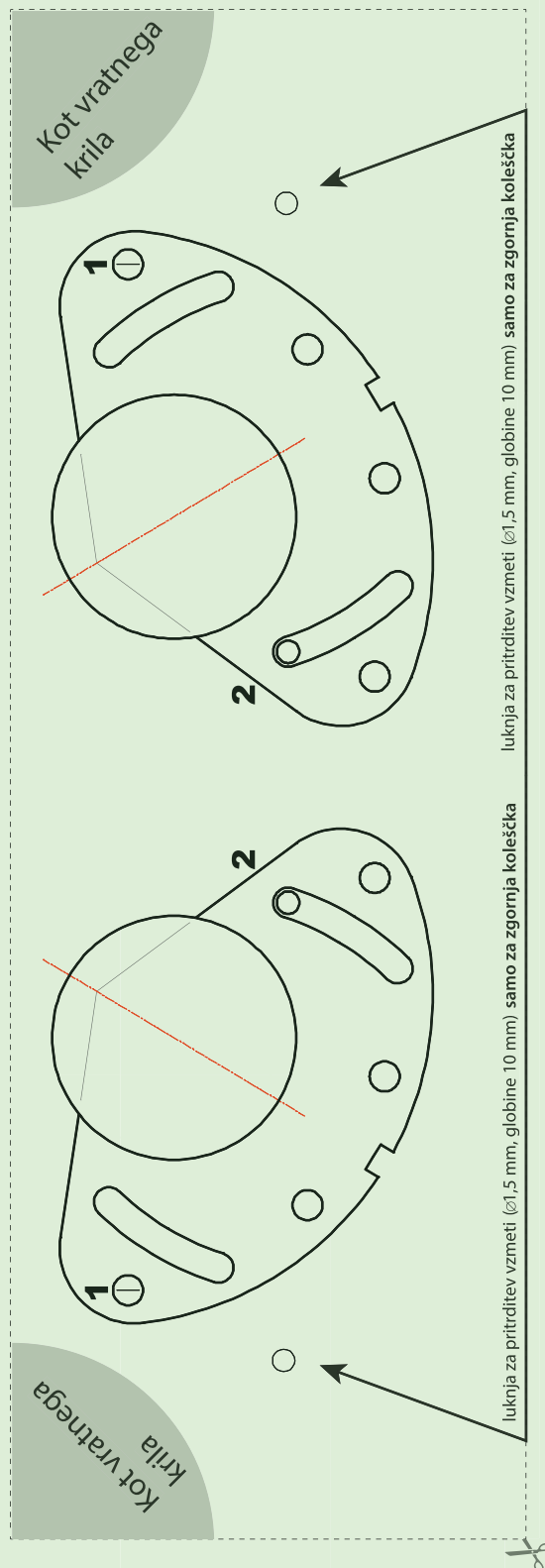

Sevroll okovje za drsna vrata

Sevroll MICRA

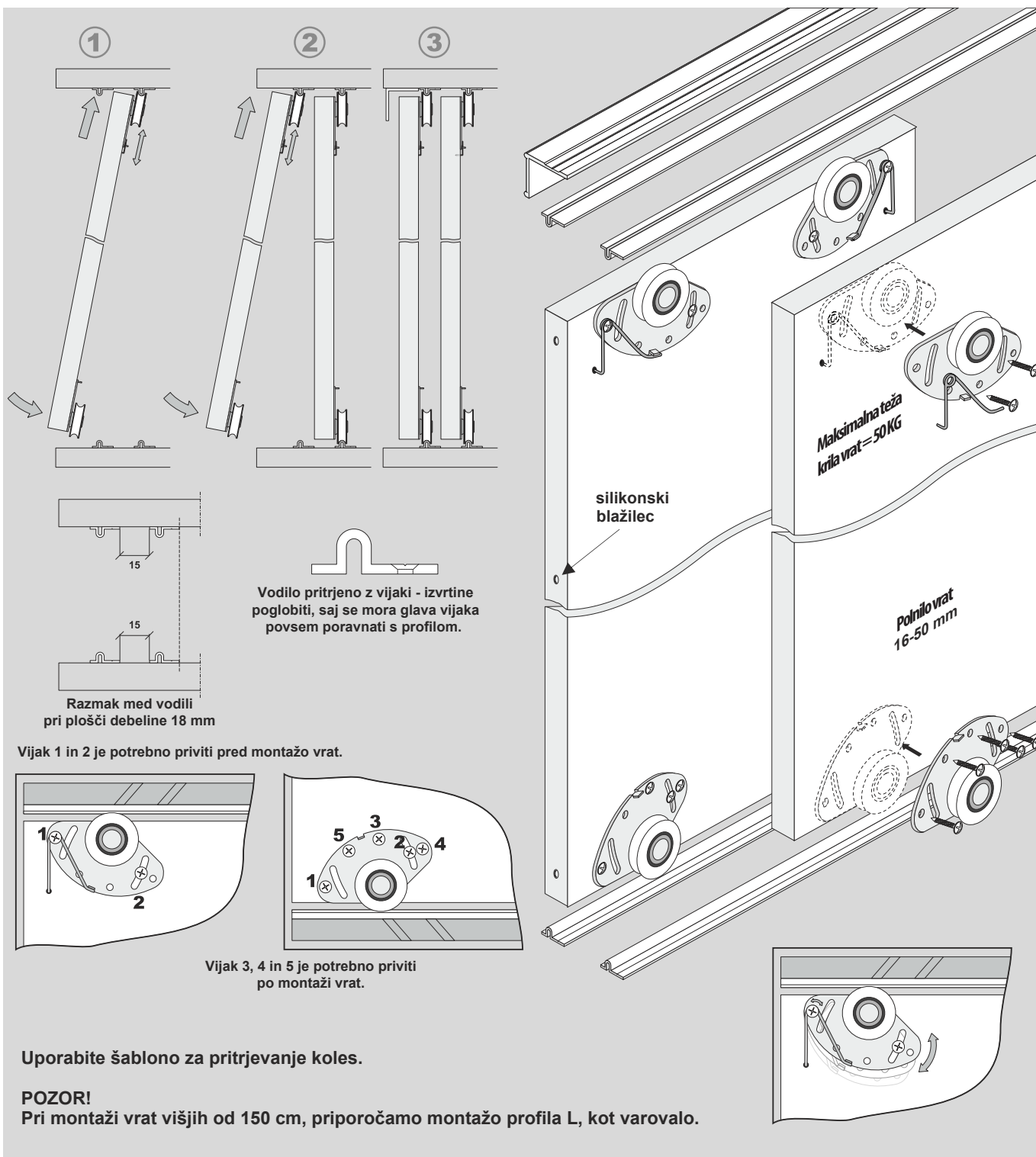

SESTAVNI DELI

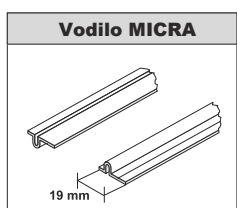

Dolžina 3.0 m

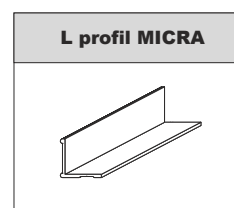
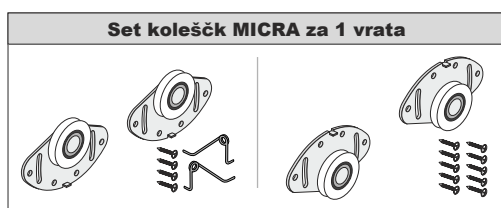

Dolžina 3.0 m

Svetla mera

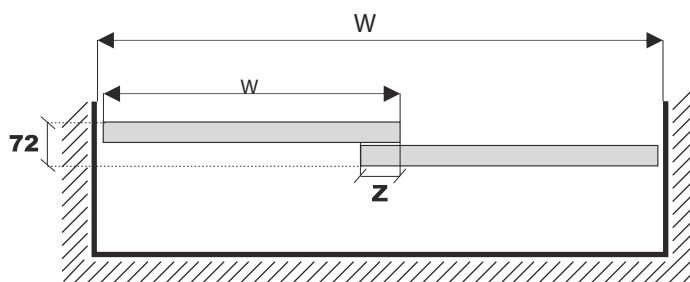
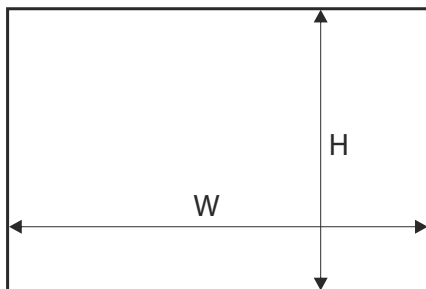

polnilo vrat 18 mm

višina vrat	- h	$h = H - 13 \text{ mm}$
višina plošče (ABS robni trak = 1 mm)	- hb	$hb = h - 2 \text{ mm}$
širina vrat	- w	$w = (W + Z) : N$
širina plošče (ABS robni trak = 1 mm)	- wb	$wb = w - 2 \text{ mm}$

število vrat	- N	2	3	4	5
prekrivanje	- Z	30 mm	60 mm	90 mm	120 mm

način prekrivanja - 4 krila	
	$w = (W + 90) : 4$
	$w = (W : 2 + 30) : 2$

POZOR!

Pri izdelavi vratnih kril upoštevajte debelino ABS robnega traku. V naših izračunih je predvidena debelina ABS-a 2mm.

Sistem MICRA lahko uporabite v kombinaciji vseh ročajev SEVROLL, ki so namenjeni plošči 18 mm.

POZOR!

Odstranite zaščitno folijo iz ALU elementov (ročaji, vodila, profili,...) predno jih režete na željeno mero. Napake v kvaliteti (primer : praske) bodo vidne po odstranjenih zaščitni foliji.



www.blazic.eu
info@blazic.eu

Blažič, Robni Trakovi, d.o.o.
Bravničarjeva 18
1000 Ljubljana
Slovenija
Evropa



 SEVROLL



vedno najnovejši katalog